



# X Series<sup>®</sup> Operator's Guide

---



Includes Real CPR Help<sup>®</sup> and See-Thru CPR<sup>®</sup>

The issue date for the X Series Operator's Guide (**REF 9650-002355-01-50 Rev 9**) is **December, 2017**.

Copyright © 2017 ZOLL Medical Corporation. All rights reserved. AED Pro, AED Plus, RapidShock, CPR-D-padz, Pedi-padz, OneStep, Real CPR Help, Rectilinear Biphasic, RescueNet, See-Thru CPR, CPR Stat-padz, Stat-padz, SurePower, Perfusion Performance Indicator, X Series, and ZOLL are trademarks or registered trademarks of ZOLL Medical Corporation in the United States and/or other countries. All other trademarks are the property of their respective owners.

Masimo, Rainbow, SET, SpCO, SpMet, SpHb, SpOC, and PVI are trademarks or registered trademarks of Masimo Corporation in the United States and/or other countries.

Propaq is a registered trademark of Welch Allyn Inc.

Oridion Microstream FilterLine<sup>®</sup> and Smart CapnoLine<sup>®</sup> are registered trademarks of Medtronic plc.



**ZOLL Medical Corporation**

269 Mill Road  
Chelmsford, MA USA  
01824-4105



**ZOLL International Holding B.V.**

Newtonweg 18  
6662 PV ELST  
The Netherlands



**0123**

# Indications for Use

## Defibrillator Function

The X Series system is indicated for defibrillation on victims of cardiac arrest where there is apparent lack of circulation as indicated by:

- Unconsciousness.
- Absence of breathing.
- Absence of pulse.

The X Series system in the Manual mode is indicated for synchronized cardioversion of certain atrial or ventricular arrhythmias. A qualified physician must decide when synchronized cardioversion is appropriate.

The X Series system Semiautomatic and Manual mode is indicated for use in early defibrillation programs where the delivery of a defibrillator shock during resuscitation involving CPR, transportation, and definitive care are incorporated into a medically-approved patient care protocol.

The X Series system Semiautomatic and Manual mode is indicated for adult and pediatric patients.

## Electrocardiogram (ECG) Monitoring

The X Series system is indicated to monitor and/or record 3-, 5-, or 12-lead electrocardiogram (ECG) waveform and heart rate, and to alarm when heart rate is above or below limits set by the operator. ECG monitoring is indicated for patients from newborn (neonate) to adult, with and without heart dysfunction.

## CPR Monitoring

The X Series system is indicated to provide visual and audio feedback via the CPR Monitoring function, designed to encourage rescuers to perform chest compressions at the AHA/ERC recommended depth and rate of 2 inches (5 cm) and 100 compressions per minute.

## External Transcutaneous Pacing

The X Series system is indicated for temporary external cardiac pacing in conscious or unconscious patients as an alternative to endocardial stimulation. External Pacing is indicated for pediatric and adult patients.

## Non-Invasive Blood Pressure Monitoring

The X Series system is indicated for use to make non-invasive measurements of arterial pressure and heart rate, and to alarm if either parameter is outside of the limits set by the user. The non-invasive blood pressure monitoring feature is indicated for patients from newborn (neonate) to adult.

## Temperature Monitoring

The X Series system is indicated for use to make continuous temperature measurements of rectal, esophageal, or surface temperatures, and to alarm if the temperature is outside of the limits set by the user. The temperature monitoring feature is indicated for use in patients from newborn (neonate) to adult.

## SpO2 Monitoring

The X Series system is indicated for use for continuous noninvasive monitoring of functional oxygen saturation of arterial hemoglobin (SpO2), pulse rate, and/or carboxyhemoglobin saturation (SpCO), methemoglobin saturation (SpMet), total hemoglobin (SpHb), oxygen content (SpOC), pleth variability index (PVI), and perfusion index (PI) via the pulse Co-oximeter and accessories. The pulse Co-oximeter and accessories are indicated for use on adult, pediatric, and neonatal patients during both no motion and motion conditions, and for patients who are well or poorly perfused, in hospitals, hospital-type facilities, or in mobile environments.

## Respiration Monitoring

The X Series system is indicated for use to continuously monitor respiration rate and to alarm if the rate falls outside of the range set by the operator. Because the measurement method actually measures respiratory effort, apnea episodes with continued respiratory effort (such as obstructive apnea) may not be detected. It is not intended to be used as an apnea monitor. The respiration monitoring feature is indicated for use on patients from newborn (neonate) to adult.

## CO2 Monitoring

The X Series system is indicated for use in continuous noninvasive measurement and monitoring of carbon dioxide concentration of the expired and inspired breath and breath rate. The CO2 monitoring feature is indicated for use on patients from newborn (neonate) to adult.

## Invasive Pressure Monitoring

The X Series system is indicated for use to display and make continuous invasive pressure measurements via a compatible pressure transducer. The invasive pressure monitoring feature is indicated for use on patients from newborn (neonate) to adult.

## 12-Lead Analysis

The X series system is indicated for use in acquiring, analyzing and reporting physiological data via 12-lead ECG Analysis, and to provide interpretation of the data for consideration by caregivers. The 12-lead ECG Analysis feature is indicated for use on adults (> 18 years of age).

## Web Console

The X Series system is indicated for the remote display of physiological data displayed on connected X Series systems via the Web Console feature, including electrocardiogram (ECG), non-invasive blood pressure (NIBP), temperature, and heart rate.

## Contraindications

### Semiautomatic Operation Contraindications for Use

The rhythm analysis function may not reliably identify ventricular fibrillation in the presence of an implanted pacemaker. Inspection of the electrocardiogram and clinical evidence of cardiopulmonary arrest should be the basis for any treatment of patients with implanted pacemakers. Do not use the rhythm analysis function during patient movement on a stretcher. A patient must be motionless during ECG analysis. Do not touch the patient during analysis. Cease all movement of the stretcher prior to analyzing the ECG.

## General Information

Federal (U.S.A.) law restricts this defibrillator to sale by or on the order of a physician.

# Table of Contents

## Chapter 1 General Information

Product Description .....	1-1
X Series Optional Features .....	1-3
How to Use This Manual.....	1-3
Operator's Guide Updates .....	1-3
Unpacking.....	1-4
Symbols Used on the Equipment .....	1-4
Conventions.....	1-7
X Series Intended Use.....	1-8
X Series Product Functions .....	1-8
Defibrillator Function .....	1-8
Defibrillator Output Energy .....	1-8
External Pacemaker .....	1-9
ECG Monitoring .....	1-9
Electrodes .....	1-9
Batteries .....	1-11
Ready For Use (RFU) Indicator .....	1-12
Safety Considerations.....	1-13
Warnings.....	1-13
General .....	1-13
ECG Monitoring .....	1-15
Defibrillation .....	1-16
Pacing .....	1-17
CPR .....	1-18
Pulse Oximeter .....	1-18
Noninvasive Blood Pressure .....	1-18
IBP .....	1-19
CO <sub>2</sub> .....	1-19
Respiration .....	1-19
Ferromagnetic Equipment .....	1-20
Battery .....	1-20
Operator Safety .....	1-20
Patient Safety .....	1-21
Cautions.....	1-22
Restarting the Defibrillator .....	1-22
FDA Tracking Requirements.....	1-23
Notification of Adverse Events .....	1-23
Software License .....	1-24
Service.....	1-24
The ZOLL Serial Number.....	1-26

---

## Chapter 2 Product Overview

Defibrillator Controls and Indicators.....	2-1
The Front Panel .....	2-2
Display Screen .....	2-5
Battery Status and Auxiliary Power Indicators .....	2-6
Patient Cables and Connectors .....	2-7
External Paddles .....	2-11
AC Auxiliary Power Adapter .....	2-14
DC Auxiliary Power Supply (optional) .....	2-15
Connecting the DC Auxiliary Power Supply to a Suitable Vehicle Power Source ....	2-15
Connecting AC Auxiliary Power Adapter or DC Auxiliary Power Supply .....	2-16
Navigating the Display Screen.....	2-16
Quick Access Keys .....	2-16
Navigation Keys .....	2-19
Display Brightness .....	2-19
Common Tasks .....	2-20
Setting the Date and Time .....	2-20
Changing the Display Brightness .....	2-22
Replacing a Battery Pack on the X Series .....	2-22
Using Treatment Buttons .....	2-23

## Chapter 3 Monitoring Overview

X Series Monitoring Functions.....	3-1
ECG .....	3-2
Heart Rate .....	3-2
Respiration Rate .....	3-2
Temperature .....	3-2
Invasive Pressures (IBP) .....	3-2
Non-Invasive Blood Pressure (NIBP) .....	3-2
Capnography (CO <sub>2</sub> ) .....	3-3
Pulse Oximetry (SpO <sub>2</sub> ) .....	3-3
Monitoring Display Options.....	3-4
Configuring the Waveform Display .....	3-6

## Chapter 4 Trends

Displaying the Trends Status Window .....	4-2
Printing Trend Information .....	4-3
Printing Trend Summary of All Trends .....	4-3
Printing an Individual Trend Snapshot .....	4-3
Printing The 10 Most Recent Trend Snapshots .....	4-3
Printing Specific Trend Snapshots .....	4-3
Changing the Trends Status Window Display.....	4-4
Continuous Waveform Recording .....	4-5

## Chapter 5 Alarms

Visual Alarm Indicators .....	5-2
Audible Alarm Indicators .....	5-2
Alarm Indicator Self-Test.....	5-2
Patient Alarm Display.....	5-3
Life Threatening Rhythm Alarms.....	5-4
Equipment Alert Display.....	5-4
Responding to Active Alarms .....	5-5
Re-enabling an Alarm .....	5-5
Latching Alarms .....	5-5
Pausing (Suspending) Alarms .....	5-6
Alarm Reminders .....	5-6
Alarm Options .....	5-7
Selecting Default Alarm Limits .....	5-8
Setting Alarm Limits Relative to the Patient -- Stat Set Option .....	5-8

## Chapter 6 Monitoring ECG

ECG Monitoring Setup.....	6-3
Preparing the Patient for Electrode Application .....	6-3
Applying Electrodes to the Patient .....	6-4
Connecting the ECG Cable To the X Series Unit .....	6-6
Selecting ECG Waveforms for Display .....	6-6
Selecting the Waveform Trace Size .....	6-8
ECG Monitoring and Pacemakers .....	6-9
ECG System Messages.....	6-10

## Chapter 7 Monitoring Respiration (Resp) and Heart Rate (HR)

Respiration/Breath Rate Meter .....	7-2
Using Impedance Pneumography to Measure Respiration .....	7-2
Configuring Respiration (RR/BR) Alarms and Settings.....	7-4
Enabling/Disabling RR/BR Alarms and Setting Alarm Limits .....	7-4
Using the Resp Parameter Control Panel .....	7-5
Heart Rate Meter .....	7-6
Configuring Heart Rate (HR) Meter Alarms .....	7-6
Enabling/Disabling HR Alarms and Setting Alarm Limits .....	7-6
Life Threatening Rhythm Alarms .....	7-8
Using the Heart Rate Parameter Control Panel .....	7-10
RESP System Message.....	7-10

## Chapter 8 Monitoring Non-Invasive Blood Pressure (NIBP)

How does NIBP Work? .....	8-3
The NIBP Numeric Display .....	8-4
NIBP Setup and Use.....	8-4
Selecting the NIBP Cuff .....	8-5

---

Connecting the NIBP Cuff.....	8-6
Applying the Cuff to the Patient .....	8-9
Ensuring Correct Cuff Inflation Settings.....	8-10
Configuring NIBP Alarms and Settings .....	8-11
Enabling/Disabling NIBP Alarms and Setting Alarm Limits .....	8-11
Using the NIBP Parameter Control Panel .....	8-14
NIBP System Messages .....	8-16

## Chapter 9 Monitoring CO2

Overview .....	9-1
CO2 Monitoring Setup and Use .....	9-2
Selecting the CO2 Sampling Line .....	9-3
Connecting the CO2 Sampling Lines .....	9-4
Applying a FilterLine Set .....	9-5
Applying a Smart CapnoLine Nasal or Nasal/Oral Cannula .....	9-6
Measuring CO2.....	9-7
Setting CO2 and Respiration Rate Alarms .....	9-8
Enabling/Disabling Alarms and Setting CO2 Alarm Limits .....	9-8
Using the CO2 Parameter Control Panel .....	9-10
CO2 System Messages .....	9-11
Patents.....	9-12

## Chapter 10 Pulse CO-Oximetry (SpO2)

Warnings -- SpO2 General .....	10-3
Cautions.....	10-5
SpO2 Accuracy Specifications .....	10-7
SpO2 Setup and Use.....	10-12
Selecting the SpO2 Sensor .....	10-12
Applying the SpO2 Sensor .....	10-12
Applying a Two-Piece Single-Use Sensor/Cable .....	10-13
Applying a Reusable Sensor/Cable .....	10-14
Cleaning and Reuse of Sensors .....	10-15
Connecting the SpO2 Sensor .....	10-15
Displaying Measurements .....	10-16
Enabling/Disabling SpO2 Alarms and Setting Alarm Limits .....	10-16
Setting Upper and Lower SpO2 Alarm Limits .....	10-17
Setting Upper and Lower SpCO and SpMet Alarm Limits .....	10-17
Setting Upper and Lower SpHb Alarm Limits .....	10-18
Setting Upper and Lower SpOC Alarm Limits .....	10-18
Setting Upper and Lower PVI Alarm Limits .....	10-19
Setting Upper and Lower PI Alarm Limits .....	10-19
Using the SpO2 Parameter Control Panel.....	10-20
SpCO and SpMet, and SpHb, SpOC, PVI and PI Monitoring .....	10-20
Specifying the SpO2 Averaging Time .....	10-20
Selecting the SpO2 Sensitivity .....	10-20



Selecting SpHb Venous Mode .....	10-21
Specifying the SpHb Averaging Time .....	10-21
Selecting the Heart Rate/ Pulse Rate (HR/PR) Tone .....	10-21
SpO2 System Messages .....	10-21
Functional Testers and Patient Simulators.....	10-22
Patents.....	10-22

## Chapter 11 Monitoring Invasive Pressures (IBP)

Invasive Pressure Transducers .....	11-1
IBP Setup.....	11-2
Attaching the Invasive Pressure Transducer .....	11-3
Zeroing the Transducer.....	11-4
Rezeroing a Transducer .....	11-5
Displaying IBP Measurements.....	11-5
Conditions Affecting IBP Measurements .....	11-5
Enabling/Disabling IBP Alarms and Setting Alarm Limits.....	11-6
Setting Upper and Lower Systolic (SYS) Alarm Limits .....	11-6
Setting Upper and Lower Diastolic (DIA) Alarm Limits .....	11-7
Setting Upper and Lower Mean Arterial Pressure (MEAN) Alarm Limits .....	11-7
Setting IBP Source Label .....	11-8
IBP System Messages.....	11-9

## Chapter 12 Monitoring Temperature

Temperature Monitoring Setup .....	12-1
Selecting and Applying Temperature Probes .....	12-2
Connecting the Temperature Probe .....	12-2
Displaying Temperature .....	12-2
Enabling/Disabling Temperature Alarms and Setting Alarm Limits .....	12-3
Setting Upper and Lower Temperature Alarm Limits .....	12-3
Setting Upper and Lower Temperature Alarm Limits .....	12-4
Selecting the Temperature Label .....	12-5
Temperature System Messages .....	12-6

## Chapter 13 Automated External Defibrillator (AED) Operation

AED Operation.....	13-2
Determine Patient Condition Following Medical Protocols .....	13-2
Begin CPR Following Medical Protocols .....	13-2
Prepare Patient .....	13-3
1 Turn on unit .....	13-4
2 Analyze .....	13-5
3 Press SHOCK .....	13-7
RapidShock .....	13-8
The Shock Conversion Estimator .....	13-8
Operating Messages .....	13-8
Audio and Display Messages .....	13-9

---

Switching to Manual Mode Operation .....	13-10
--	-------

## Chapter 14 12-Lead ECG Interpretive Analysis

Entering Patient Information .....	14-3
Entering the Patient Name and ID .....	14-3
Entering Patient Age and Gender .....	14-4
12-Lead ECG Monitoring Setup .....	14-4
Preparing the Patient for Electrode Application .....	14-5
Applying Electrodes to the Patient .....	14-5
Connecting the 12-Lead Cable .....	14-7
Observing the 12-Lead Waveform Traces .....	14-7
12-Lead Interpretive Analysis .....	14-8
Fault Conditions Affecting 12-Lead Interpretive Analysis .....	14-11
Printing 12-Lead Waveform Traces .....	14-12
12-Lead Print and Display Options .....	14-13
Selecting 12-Lead Acquire .....	14-13
Specifying the Number of 12-Lead Print Copies .....	14-13
Specifying the 12-Lead Print Format .....	14-14
Printing 10 Seconds of Waveform Traces .....	14-16
Specifying the 12-Lead Frequency Response .....	14-16
Enabling 12-Lead Analysis .....	14-16
Enabling Interpretive Text .....	14-16

## Chapter 15 Manual Defibrillation

Emergency Defibrillation Procedure with Paddles .....	15-1
Determine the Patient's Condition Following Local Medical Protocols .....	15-2
Begin CPR Following Local Medical Protocols .....	15-2
Turn On Unit .....	15-2
1 Select Energy Level .....	15-2
2 Charge Defibrillator .....	15-3
3 Deliver Shock .....	15-5
Emergency Defibrillation Procedure with Hands-Free Therapy Electrodes .....	15-6
Determine the Patient's Condition Following Local Medical Protocols .....	15-6
Begin CPR Following Medical Protocols .....	15-6
Prepare Patient .....	15-6
Turn On Unit .....	15-7
1 Select Energy Level .....	15-7
2 Charge Defibrillator .....	15-8
3 Deliver Shock .....	15-9
Internal Paddles .....	15-9
Verification Prior to Use .....	15-10
Synchronized Cardioversion .....	15-11
Synchronized Cardioversion Procedure .....	15-12
Determine the Patient's Condition and Provide Care Following Local Medical Protocols .....	15-12
Prepare Patient .....	15-12
Turn On Unit .....	15-12
Press the Sync Key .....	15-12

1 Select Energy Level .....	15-13
2 Charge Defibrillator .....	15-13
3 Deliver Shock .....	15-14

## Chapter 16 Advisory Defibrillation

Advisory Defibrillation Procedure.....	16-2
Determine the Patient's Condition Following Local Medical Protocols .....	16-2
Begin CPR Following Local Medical Protocols .....	16-2
Prepare Patient .....	16-2
1 Turn on unit .....	16-3
2 Press ANALYZE Button .....	16-4
3 Press SHOCK button .....	16-5

## Chapter 17 Analysis/CPR Protocol Defibrillation

Analysis/CPR Protocol Defibrillation Procedure .....	17-2
Determine the Patient's Condition Following Local Medical Protocols .....	17-2
Begin CPR Following Local Medical Protocols .....	17-2
Prepare Patient .....	17-2
1 Turn on unit .....	17-3
2 Press ANALYZE Button .....	17-4
3 Press SHOCK button .....	17-5
RapidShock .....	17-6
The Shock Conversion Estimator .....	17-6

## Chapter 18 External Pacing

External Pacing.....	18-2
Pacer Modes .....	18-2
Pacing in Demand Mode .....	18-2
Determine Patient Condition and Provide Care Following Local Medical Protocols .	18-2
Prepare the Patient .....	18-2
1 Turn On Unit .....	18-2
2 Apply ECG Electrodes/Hands-Free Therapy Electrodes .....	18-3
3 Press PACER button .....	18-3
4 Set Mode .....	18-4
5 Set Pacer Rate .....	18-4
6 Turn On Pacer .....	18-4
7 Set Pacer Output .....	18-4
8 Determine Capture .....	18-5
9 Determine Optimum Threshold .....	18-5
Pacing in Fixed Mode .....	18-6
1 Turn On Unit .....	18-6
2 Apply ECG Electrodes/Hands-Free Therapy Electrodes .....	18-6
3 Press PACER button .....	18-7
4 Set Mode .....	18-7
5 Set Pacer Rate .....	18-7
6 Turn On Pacer .....	18-7
7 Set Pacer Output .....	18-8
8 Determine Capture .....	18-8

9 Determine Optimum Threshold .....	18-8
Pediatric Pacing .....	18-9

## Chapter 19 Real CPR Help

CPR Voice Prompts (Adult Only) .....	19-3
CPR Metronome .....	19-3
Constant Metronome Enabled .....	19-3
Constant Metronome Disabled .....	19-4
FULLY RELEASE Prompt .....	19-5
CPR Dashboard.....	19-5
CPR Rate and Depth Measurements .....	19-5
CPR Release Indicator (Adult Only) .....	19-6
Chest Compression Indicator (Adult Only) .....	19-6
CPR Countdown Timer .....	19-6
CPR Idle Time Display .....	19-6
CPR Compression Bar Graph (Adult Only) .....	19-7

## Chapter 20 See-Thru CPR

Using See-Thru CPR.....	20-2
Examples .....	20-3

## Chapter 21 Patient Data

Storing Data.....	21-2
Log Capacity Indicator .....	21-2
Capturing a Data Snapshot .....	21-2
Reviewing and printing snapshots .....	21-3
Treatment Summary Report .....	21-3
Printing Treatment Summary Report .....	21-3
Transferring Data to a USB Device.....	21-4
Clearing the Log .....	21-5

## Chapter 22 Communications

The Wireless Icon .....	22-2
The Wireless Menu.....	22-4
Selecting a Pre-Configured Access Point Profile .....	22-5
Creating a Temporary Access Point Profile .....	22-6
Bluetooth Device Pairing .....	22-10
Sending a 12-Lead Report.....	22-12
Sending Disclosure Logs .....	22-13
Supervisor Communications Menu .....	22-14
Overview .....	22-14
Accessing the Communications Menu .....	22-14
Wi-Fi Access Point Profiles .....	22-16
Setting up Cellular Communications .....	22-23
Setting up an Ethernet Connection .....	22-28

Configuring 12-Lead Report Transmissions .....	22-29
Configuring Disclosure Log Transmissions .....	22-30
Data Services .....	22-32
Configuring Clock Synchronization .....	22-34
Communications System Messages.....	22-36
Transmission Status Icons.....	22-37

## Chapter 23 Printing

Printing Patient Data.....	23-1
Printer Setup .....	23-2
Automatic Prints .....	23-2
Printing Waveforms .....	23-2
Printing Reports .....	23-3
Printing Trends .....	23-4

## Chapter 24 Maintenance

Daily/Shift Check Procedure.....	24-2
Inspection .....	24-2
Defibrillator/Pacing Test with Hands-Free Therapy Electrodes.....	24-3
Defibrillator Testing with External Paddles.....	24-5
Recommended Minimum Preventive Maintenance Schedule .....	24-7
Annually .....	24-7
Guidelines for Maintaining Peak Battery Performance .....	24-7
Cleaning instructions .....	24-8
Cleaning the X Series unit .....	24-8
Cleaning the NIBP Blood Pressure Cuff .....	24-8
Cleaning SpO2 Sensors .....	24-8
Cleaning Cables and Accessories .....	24-9
Loading Recorder Paper .....	24-9
Cleaning the Print Head .....	24-10

## Appendix A Specifications

Defibrillator.....	A-2
Monitor/Display .....	A-14
Impedance Pneumography.....	A-15
Alarms.....	A-16
Recorder .....	A-17
Battery .....	A-17
General .....	A-18
Pacer .....	A-19
CO2 .....	A-19
Pulse Oximeter .....	A-20
Non-Invasive Blood Pressure .....	A-23
Invasive Pressures .....	A-24
Temperature.....	A-25

Clinical Trial Results for the Biphasic Waveform .....	A-26
Randomized Multicenter Clinical Trial for Defibrillation of Ventricular Fibrillation (VF) and Ventricular Tachycardia (VT) .....	A-26
Randomized Multi-Center Clinical trial for Cardioversion of Atrial Fibrillation (AF) .....	A-27
Pre-Clinical Study .....	A-29
Published Clinical Data .....	A-30
Synchronized Cardioversion of Atrial Fibrillation .....	A-31
Electromagnetic Compatibility Guidance and Manufacturer’s Declaration .....	A-32
Electromagnetic Immunity (IEC 60601-1-2) .....	A-33
Electromagnetic Immunity .....	A-34
ECG Analysis Algorithm Accuracy .....	A-38
Clinical Performance Results .....	A-38
Shock Conversion Estimator .....	A-41
Wireless Output Guidance and Manufacturer’s Declaration.....	A-43
RF Transmission Emitted (IEC 60601-1-2) .....	A-43
FCC Notice .....	A-43
Canada, Industry Canada (IC) Notices .....	A-43

## Appendix B Accessories

# Chapter 1

## General Information

---

### Product Description

The ZOLL® X Series® unit is an easy-to-use portable defibrillator that combines defibrillation and external pacing with the following monitoring capabilities:

- ECG
- CO-Oximeter
- Non-invasive Blood Pressure
- IBP
- CO<sub>2</sub>
- Temperature
- Respiration

The X Series is a rugged, compact and lightweight unit that is designed for all resuscitation situations and is ideal for transport. The X Series is powered by auxiliary power as well as an easily replaceable battery pack that quickly recharges when the X Series is connected to auxiliary power. In addition, you can use a ZOLL *SurePower™ Battery Charger Station* to recharge and test the X Series battery.

**Note:** The X Series has defibrillation and pacing functionality, but some of the monitoring functions are optional features. See the complete list of options in Fig. 1-1. All features are included in this manual, but only purchased features will be available on your unit.

The product is designed for use in both the hospital and the rugged EMS environment. The device is a versatile automated external defibrillator with manual capabilities and may be configured to operate in Manual, Advisory or Semiautomatic modes. It can be configured to start up in Semiautomatic (AED) mode or manual mode.

When operating in manual configuration, the device operates as a conventional defibrillator where the device's charging and discharging is fully controlled by the operator. In Advisory and AED modes, some features of the device are automated and a sophisticated detection algorithm is used to identify ventricular fibrillation and determine the appropriateness of defibrillator shock delivery. Units may be configured to automatically charge, analyze, recharge, and prompt the operator to "PRESS SHOCK", depending on local protocols. The unit is switched from AED mode to Manual mode for ACLS use by pressing the appropriate key on the front panel.

The X Series unit assists caregivers during cardiopulmonary resuscitation (CPR) by evaluating the rate and depth of chest compressions and providing feedback to the rescuer.

Real CPR Help<sup>®</sup> requires the use of ZOLL OneStep<sup>™</sup> CPR electrodes, OneStep<sup>™</sup> Complete electrodes, or CPR-D-padz<sup>®</sup>. When using these pads, the displayed ECG waveforms can be adaptively filtered, using the See-Thru CPR<sup>®</sup> feature, to reduce the artifact caused by chest compressions.

The unit has a large colorful LCD display of numerics and waveform data that provides easy visibility from across the room and at any angle. ECG, plethysmograph, and respiration waveform traces can be displayed simultaneously, giving easy access to all patient monitoring data at once. The display screen is configurable, so you can choose the best visual layout to fit your monitoring needs. The X Series includes a transcutaneous pacemaker consisting of a pulse generator and ECG sensing circuitry. Pacing supports both demand and fixed noninvasive pacing for adult patients and adolescent, child, and infant pediatric patients.

The X Series has a patient data review and collection system that allows you to view, store, and transfer patient data. The X Series unit contains a printer and USB port, which you can use to print the data and transfer it to a PC.

The X Series unit can send data through a wireless connection to remote locations. The X Series unit can send 12-lead report snapshots (including trend data) or Disclosure Logs to a recipient via a ZOLL server. In addition full disclosure cases, which also contain trend data, can be automatically retrieved from the X Series unit using ZOLL RescueNet or ePCR software.



## X Series Optional Features

The following features are optional in the X Series unit.

**Note:** All features are included in this manual, but only purchased features will be available on your unit.

**Figure 1-1 X Series Optional Features**

Optional Feature
12-Lead ECG with Interpretation
SpO <sub>2</sub> (Masimo <sup>®</sup> ) with SpCO <sup>®</sup> and SpMet <sup>®</sup>
SpHb <sup>®</sup> (Masimo <sup>®</sup> ) with SpOC <sup>™</sup> , PVI <sup>®</sup> and PI
NIBP (with Smartcuf <sup>®</sup> and SureBP <sup>™</sup> )
EtCO <sub>2</sub> (Oridion <sup>®</sup> Microstream <sup>®</sup> )
Temperature (2 Channels)
Invasive Pressures (3 Channels)
Advanced CPR Help
Pacing
Microphone

## How to Use This Manual

The X Series Operator's Guide provides information operators need for the safe and effective use and care of the X Series product. It is important that all persons using this device read and understand all the information contained within.

Please thoroughly read the safety considerations and warnings section.

Procedures for daily checkout and unit care are located in the Chapter 24, "Maintenance".

This manual is supplemented by manual insert(s) for option(s) available on the X Series. These insert(s) contain additional warnings, precautions, and safety-related information.

## Operator's Guide Updates

An issue or revision date for this manual is shown on the front cover. If more than three years have elapsed since this date, contact ZOLL Medical Corporation to determine if additional product information updates are available.

All users should carefully review each manual update to understand its significance and then file it in its appropriate section within this manual for subsequent reference.












Product documentation is available through the ZOLL website at [www.zoll.com](http://www.zoll.com). From the Products menu, choose Product Manuals.




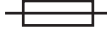










## Unpacking















Carefully inspect each container for damage. If the shipping container or cushion material is damaged, keep it until the contents have been checked for completeness and the instrument has been checked for mechanical and electrical integrity. If the contents are incomplete, if there is mechanical damage, or if the defibrillator does not pass its electrical self-test, U.S.A. customers should call ZOLL Medical Corporation (1-800-348-9011). Customers outside of the U.S.A. should contact the nearest ZOLL authorized representative. If the shipping container is damaged, also notify the carrier.










## Symbols Used on the Equipment

Any or all of the following symbols may be used in this manual or on this equipment:

Symbol	Description
	Class II equipment.
	Dangerous voltage.
	General warning: Observe and follow all safety signs.
	Hot surface.
	Fragile, handle with care.
	Keep dry.
	This end up.
	Temperature limitation.
	<b>Conformité Européenne</b> Complies with medical device directive 93/42/EEC.
	Type B patient connection.
	Type BF patient connection.

Symbol	Description
	Type CF patient connection.
	Defibrillator-proof type BF patient connection.
	Defibrillator-proof type CF patient connection.
	Fusible link.
	Equipotentiality.
	Alternating current (ac).
	Direct current (dc).
	Auxiliary power adapter operation.
	Caution, high voltage.
	Earth (ground).
	Negative input terminal.
	Positive input terminal.
	Power On/Off
	Protective earth (ground).

Symbol	Description
	Contains lithium. Recycle or dispose of properly.
	Keep away from open flame and high heat.
	Do not open, disassemble, or intentionally damage.
	Do not crush.
	Do not discard in trash. Recycle or dispose of properly.
	Return to a collection site intended for waste electrical and electronic equipment (WEEE). Do not dispose of in unsorted trash.
	Date of manufacture.
	Use by.
	Latex-free.
	Do not reuse.
	Do not fold.
	Not sterile.
	Manufacturer.
	Authorized representative in the European Community.

Symbol	Description
	Serial Number.
	Catalogue number.
	Consult instructions for use.
	Refer to instruction manual/booklet.
<b>Rx ONLY</b>	Prescription only.
	Alarm audio is currently off.
	Alarm audio is currently paused.
	Pacer indicator disabled.
	Battery charging status.
	MR unsafe: keep away from magnetic resonance imaging equipment.

## Conventions

This guide uses the following conventions:

Within text, the names and labels for physical buttons and softkeys appear in **boldface** type (for example, “Press the **CHARGE** button or press the **PACER** button”).

This guide uses uppercase italics for audible prompts and for text messages displayed on the screen (for example, *LEAD FAULT*).

---

**Warning!**     **Warning statements alert you to conditions or actions that can result in personal injury or death.**

---



---

**Caution**     Caution statements alert you to conditions or actions that can result in damage to the unit.

---

## X Series Intended Use

The X Series is intended for use by trained medical personnel who are familiar with basic monitoring, vital sign assessment, emergency cardiac care, and the use of the X Series. The X Series is also intended for use by (or on the order of) physicians at the scene of an emergency or in a hospital emergency room, intensive care unit, cardiac care unit, or other similar areas of a hospital. The usage may be in an ambulance or at the scene of an emergency. It is also intended to be used during the transport of patients. The X Series will be used primarily on patients experiencing symptoms of cardiac arrest or in post trauma situation. It may also be used whenever it is required to monitor any of those functions that are included (as options) in the device. The X Series unit can be used on pediatric patients (as described in the following table) and on adult patients (21 years of age or older) with and without heart dysfunction.

<b>Pediatric Patient Subpopulation</b>	<b>Approximate Age Range</b>
Newborn (neonate)	Birth to 1 month of age.
Infant	1 month to 2 years of age.
Child	2 to 12 years of age.
Adolescent	12 to 21 years of age.

When the pediatric patient is less than 8 years of age or weighs less than 55 lbs. (25 kg.), use ZOLL pediatric defibrillation electrodes. Do not delay therapy to determine the patient's exact age or weight.

## X Series Product Functions

### Defibrillator Function

The X Series contains a direct current (dc) defibrillator capable of delivering up to 200 joules. It may be used in synchronized mode to perform synchronized cardioversion using the patient's R-wave as a timing reference. The unit uses paddles or disposable, pregelled electrodes for defibrillation.

### Defibrillator Output Energy

X Series defibrillators can deliver biphasic energy from 1 joule to 200 joules. The energy delivered through the chest wall, however, is determined by the patient's transthoracic impedance. An adequate amount of electrolyte gel must be applied to the paddles and a force of 10 to 12 kilograms (22 to 26.4 pounds) must be applied to each paddle in order to minimize this impedance. If hands-free therapy electrodes are used, make sure that they are properly applied. (Refer to the instructions on the electrode package).

## External Pacemaker

X Series defibrillators include a transcutaneous pacemaker consisting of a pulse generator and ECG-sensing circuitry. Noninvasive transcutaneous pacing (NTP) is an established and proven technique. This therapy is easily and rapidly applied in both emergency and nonemergency situations when temporary cardiac stimulation is indicated.

The output current of the pacemaker is continuously variable from 10 to 140 mA (the output current is 0 mA when paused). The rate is continuously variable from 30 to 180 pulses per minute (ppm), by increments of 5 ppm (10 bpm when greater than 100 ppm).

The pacing output pulse is delivered to the heart via ZOLL hands-free defibrillation/pacing electrodes placed on the patient's back and the precordium.

Proper operation of the device, together with correct electrode placement, is critical to obtaining optimal results. Every operator must be thoroughly familiar with these operating instructions.

## ECG Monitoring

The patient's ECG is monitored by connecting the patient to the unit via a 3-, 5-, or 12-lead patient cable or hands-free therapy electrodes. The ECG waveform is presented on the display along with the following information:

- averaged heart rate, derived by measuring R to R intervals
- lead selection - I, II, III, aVR, aVL, aVF, V1, V2, V3, V4, V5, V6 (with ECG cable), PADDLES, or PADS.
- ECG size - 0.125, 0.25, 0.50, 1.0, 2.0, 4.0 cm/mV, AUTO
- status messages

The ECG bandwidth is user selectable.

## Electrodes

The X Series units will defibrillate, cardiovert, and monitor ECG using hands-free therapy electrodes. The X Series unit will pace using ZOLL hands-free therapy electrodes.

**Energy Select, Charge and Shock** controls are located on the paddles and front panel. When using hands-free therapy electrodes, you must use the controls on the front panel of the unit. To switch between paddles and hands-free therapy electrodes, remove the multifunction cable (MFC or OneStep) from the apex paddle and connect the hands-free therapy electrodes to the cable.

You should always check the expiration date on the electrode packaging. Do not use expired electrodes, which might result in false patient impedance readings and affect the level of delivered energy, or cause burns.



This symbol on the electrode package is accompanied by the expiration date.

For Stat-padz<sup>®</sup> II, this symbol does not appear; the expiration date appears on the lower right corner of the label, below the lot number.

**Note:** ZOLL electrodes contain no hazardous materials and may be disposed of in general trash unless contaminated with pathogens. Use appropriate precautions when disposing of contaminated electrodes.

When the patient is less than 8 years old or weighs less than 55 lb. (25 kg), use ZOLL OneStep Pediatric defibrillation electrodes. Do not delay therapy to determine the patient's exact age or weight.



## Batteries

X Series models use an easily replaced rechargeable lithium-ion battery pack (the *SurePower II* Battery Pack). A new, fully charged battery pack typically delivers more than 6 hours of ECG monitoring. Use of other functions (such as the defibrillator, printer, or pacemaker) reduces this time.

When a *LOW BATTERY* icon appears on the display and the unit emits three beeps in conjunction with the displayed battery icon, the battery must be replaced and recharged.


You can charge the battery by either of the following methods:

- **Internal charging** — plug the X Series into an auxiliary power adapter to automatically begin charging the installed battery pack. The front panel battery indicator operates as follows:

When the indicator is:	It means:
Steady yellow	Battery is charging.
Steady green	Battery is charged.
Alternating yellow and green	The charge state cannot be determined or a battery charging fault has been detected.
Not lit	No battery in device.

**Note:** Upon power up, it takes approximately 45 seconds for the LEDs on the battery to accurately display run time.

- **External charging** — use the ZOLL SurePower Battery Charger with the X Series battery adapter to charge the battery pack and test the battery's capacity. For details, refer to the *SurePower II Battery Pack Guide*.



The Recalibration LED icon (  ) lights for approximately 10 seconds (after you press and release the Display button) if the battery needs to be calibrated. If the Recalibration LED lights, the runtime indicator will not display run time for that battery. For best performance of the battery, you should recalibrate the battery as soon as possible.

To manually recalibrate the SurePower II Battery Pack, you can insert the battery into the SurePower Charger Station and perform a Manual Test (for more information, see the ZOLL *SurePower Charger Station Operator's Guide*).

After you recalibrate the battery, the Recalibration LED will only flash when you press the Display button.

## Ready For Use (RFU) Indicator

The X Series has an RFU indicator on the front panel that indicates if the device is ready for use. The RFU indicator has three states which are described in the following table.

State	Description	Action
Ready for Use 	The device is ready for use. Patient monitoring, defibrillation, and pacing parameters are functional and the battery is above the low battery capacity.  <b>Note:</b> If the device is plugged into the auxiliary power adapter, the Ready for Use indicator may display even if the battery is depleted. Check the status of the battery before removing the device from the auxiliary power adapter.	None required.
Flashing	One or more of the following has occurred: <ul style="list-style-type: none"> <li>• The battery is not properly installed.</li> <li>• A low battery is installed.</li> <li>• A battery fault has occurred.</li> <li>• There is no battery installed while connected to auxiliary power.</li> <li>• One or more patient monitoring parameters have failed self-test (NIBP, SpO<sub>2</sub>, CO<sub>2</sub>, IBP, or Temp).</li> <li>• The front panel button self-test failed.</li> <li>• The speech database self-test failed.</li> </ul>	Install a fully charged battery in the unit and check the RFU indicator again. If the RFU indicator continues to flash, remove the unit from service and contact the appropriate technical personnel or the ZOLL Technical Service Department.
Do Not Use 	One or more of the following has occurred: <ul style="list-style-type: none"> <li>• The battery is not properly installed.</li> <li>• No battery is installed and auxiliary power is not present.</li> <li>• A very low battery (below software shutdown limit) was installed.</li> <li>• ECG, defibrillator, or pacer self-tests have failed, or other critical self-tests have failed.</li> </ul>	Install a fully charged battery in the unit and check the RFU indicator again. If the RFU indicator continues to display the Do Not Use symbol, remove the unit from service and contact the appropriate technical personnel or the ZOLL Technical Service Department.

---

## Safety Considerations



All operators should review these safety considerations before using the X Series unit.

X Series units are high-energy defibrillators capable of delivering 200 joules. To completely deactivate the unit, press the power switch to turn the unit off.

To manually disarm a charged (or charging) defibrillator, do one of the following:

- Press the **Disarm** quick access key.
- Change the selected energy.
- Press the power switch to turn the unit off.

For safety, the X Series automatically disarms if left charged for more than 60 seconds if the **SHOCK** button (ⓘ) is not pressed.

## Warnings

### General

- Only appropriately trained, skilled personnel who are familiar with equipment operation should perform emergency defibrillation. The prescribing physician should determine what training, such as Advanced Cardiac Life Support (ACLS) or Basic Life Support (BLS) certification, is appropriate.
- Only skilled personnel trained in Advanced Cardiac Life Support (ACLS) and who are familiar with equipment operation should perform synchronized cardioversion. The precise cardiac arrhythmia must be determined before attempting defibrillation.
- These operating instructions describe the functions and proper operation of the X Series products. They are not a substitute for a formal patient care training course. Operators should obtain formal training from an appropriate authority before using this defibrillator for patient care.
- Proper operation of the unit and correct electrode placement is critical to obtaining optimal results. Operators must be thoroughly familiar with proper device operation.
- The use of external pacing/defibrillation electrodes, accessories, or adapter devices from sources other than ZOLL is not recommended. ZOLL makes no representations or warranties regarding the performance or effectiveness of its products when used with pacing/defibrillation electrodes or adapter devices from other sources. Defibrillator failures attributable to the use of pacing/defibrillation electrodes or adapters not manufactured by ZOLL might void ZOLL's warranty.
- At receipt of shipment, check pacing/defibrillation electrodes to ensure compatibility.
- Allow ample slack in cables to make sure that cables do not tug at electrodes.
- Do not disassemble the unit. A shock hazard exists. Refer all problems to authorized service personnel.
- Follow all recommended maintenance instructions. If a problem occurs, obtain service immediately. Do not use the defibrillator until it has been inspected by appropriate personnel.
- The X Series unit might not perform to specifications when stored at the upper or lower extreme limits of storage temperature and then immediately put into use. The X Series unit should not be stored or used outside of the environmental limits provided in Appendix A of this manual.

- Avoid using the X Series adjacent to, or stacked on, other equipment. If unavoidable, verify that the unit operates normally in this configuration before clinical use.
- The X Series unit should be installed and put into service according to the EMC information in Appendix A of this manual.
- Do not use internal paddles while the X Series unit's auxiliary power source is connected to an aircraft AC power operating at a frequency of 400 Hz.
- The use of accessories, transducers, and cables other than those specified in this manual and related X Series option manual inserts may result in increased emissions or decreased immunity of the X Series.
- Perform functional test of internal paddles prior to use.
- Do not use or place the unit in service if the Ready For Use indicator (at the upper right of the front panel) displays a red circle with a line through it.
- Carefully route patient cables to avoid tripping over them, or inadvertently pulling the unit onto the patient.
- Always inspect the unit for damage if it has been dropped.
- Only authorized personnel should use the Supervisor menus.
- If uncertain about the accuracy of any measurement, first check the patient's vital signs by alternate means, and then make sure the monitor is functioning correctly.
- Before disposing of equipment, in order to avoid contaminating or infecting personnel, the environment, or other equipment, it is important to disinfect and decontaminate the monitor/defibrillator and any appropriate device accessories appropriately and remove the batteries. Then dispose of the device and accessories in accordance with your country's regulations for equipment containing electronic parts.
- The X Series unit is MR Unsafe. Keep the X Series defibrillator away from magnetic resonance imaging (MRI) equipment.

---

## ECG Monitoring

- Implanted pacemakers might cause the heart rate meter to count the pacemaker rate during incidents of cardiac arrest or other arrhythmias. Dedicated pacemaker detection circuitry may not detect all implanted pacemaker spikes. Check the patient's pulse; do not rely solely on heart rate meters. Patient history and physical examination are important factors in determining the presence of an implanted pacemaker. Pacemaker patients should be carefully observed. See “Pacemaker Pulse Rejection:” on page A-15 of this manual for disclosure of the pacemaker pulse rejection capability of this instrument.
- Use only ECG electrodes that meet the AAMI standard for electrode performance (AAMI EC-12). Use of electrodes not meeting this AAMI standard could cause the ECG trace recovery after defibrillation to be significantly delayed.
- Prior to attempting synchronized cardioversion, ensure the ECG signal quality is good and that sync markers are displayed above each QRS complex.
- Do not place electrodes directly over an implanted pacemaker.
- The X Series unit detects ECG electrical signals only. It does not detect a pulse (effective circulatory perfusion). Always verify pulse and heart rate by physical assessment of the patient. Never assume that the display of a nonzero heart rate means that the patient has a pulse.
- Excessive artifact can result due to improper skin preparation of the electrode sites. Follow skin preparation instructions in Chapter 6: “Monitoring ECG.”
- Equipment such as electrocautery or diathermy equipment, RFID readers, electronic article surveillance (EAS) systems, or metal detectors that emit strong radio frequency signals can cause electrical interference and distort the ECG signal displayed by the monitor, thereby preventing accurate rhythm analysis. Ensure adequate separation between such emitters, the device, and the patient when performing rhythm analysis.
- Shock Hazard: Use of accessories, other than those specified in the operating instructions, may adversely affect patient leakage currents.
- Certain line-isolation monitors may cause interference on the ECG display and may inhibit heart rate alarms.
- Monitoring ECG through the paddles may result in inaccurate heart rate display due to artifact.

## Defibrillation

- The ZOLL X Series can deliver 200 joules of electrical energy. If this electrical energy is not discharged properly, as described in the this manual, the electrical energy could cause personal injury or death to the operator or bystander.
- To avoid possible damage to the X Series unit, turn off pacing before defibrillating the patient with a second defibrillator.
- After a synchronized cardioversion, the SYNC mode may be cleared after each shock or disarm. The user may have to reselect (press) the SYNC button after each synchronized cardioversion shock performed on a patient. In Defib/Pacer Default settings in the Supervisor Setup menu, the X Series can be configured to remain in the SYNC mode after each synchronized cardioversion.
- Synchronized cardioversion can be performed in the paddle monitoring mode. However, it is possible that artifact can be produced by the moving paddles, which could cause the defibrillator to trigger on the artifact. It is recommended that monitoring in leads I, II or III be used during synchronized cardioversion. Paddle monitoring should not be used for elective cardioversions procedures.
- To avoid stress to the defibrillator or the tester, never attempt to repeatedly charge and discharge the defibrillator in rapid succession. If a need for repetitive testing arises, allow a waiting period of at least 2 minutes after every third discharge.
- In the SYNC mode, the defibrillator does not discharge without a command signal (R-wave detection) from the ECG monitor indicated by a SYNC marker on the trace and a flashing SYNC indicator.
- If conductive gel forms a continuous path between the defibrillator electrodes, delivered energy may be dramatically reduced to zero. In this case, reposition the electrodes to eliminate the shunting path before attempting additional shocks.
- Improper defibrillation technique can cause skin burns. To limit possible skin burns, use only ZOLL defibrillation gel on paddles, ensure the gel covers the entire paddle surface and press firmly against patient's chest.
- If a new energy level is selected after the **CHARGE** button is pushed and while the defibrillator is charging or charged, the defibrillator will disarm. The **CHARGE** button will need to be pressed again to charge to the new energy level.
- Prior to defibrillation, disconnect from the patient any medical electronic device that is not labeled "defibrillation protected."
- Before charging the defibrillator, verify that the energy selected on the display is the desired output.
- Defibrillation takes priority over external pacing. Should the defibrillator be charged during the administration of external pacing, the pacer turns off and the defibrillator charges to the selected energy.
- If the X Series unit is in a shock-ready state, and you have to change the patient mode, wait until the unit disarms itself. Pressing the **SHOCK** button immediately after changing the patient mode may result in the delivery of energy that is incorrect for the newly selected patient type.
- When using external or internal paddle sets, the X Series unit may display the *RELEASE SHOCK BUTTON* message while the unit is charging. If you are pressing the paddles' shock buttons when the *RELEASE SHOCK BUTTON* message appears, you must release the shock buttons for the unit to become shock-ready. If you are not pressing the paddles' shock buttons when the *RELEASE SHOCK BUTTON* message appears, then the paddles are defective -- replace the defective paddles immediately with either another set of paddles or a multifunction electrode. **DO NOT** attempt to deliver therapy using the defective paddles by pressing the **SHOCK** button on the face of the X Series unit -- pressing the **SHOCK** button will **NOT** deliver therapy; pressing the **SHOCK** button will, however, cause the X Series unit to remove the *RELEASE SHOCK BUTTON* message from the display.

---

## Pacing

- Ventricular fibrillation does not respond to pacing and requires immediate defibrillation. Therefore, the patient's dysrhythmia must be determined immediately, so that you can employ appropriate therapy. If the patient is in ventricular fibrillation and defibrillation is successful but cardiac standstill (asystole) ensues, you should use the pacemaker.
- Ventricular or supraventricular tachycardias can be interrupted with pacing, but in an emergency or during circulatory collapse, synchronized cardioversion is faster and more certain.
- Pulseless electrical activity (PEA) can occur following prolonged cardiac arrest or in other disease states with myocardial depression. Pacing might then produce ECG responses without effective mechanical contractions, making other effective treatment necessary.
- Pacing can evoke undesirable repetitive responses, tachycardia, or fibrillation in the presence of generalized hypoxia, myocardial ischemia, cardiac drug toxicity, electrolyte imbalance, or other cardiac diseases.
- Pacing by any method tends to inhibit intrinsic rhythmicity. Abrupt cessation of pacing, particularly at rapid rates, can cause ventricular standstill and should be avoided.
- Noninvasive temporary pacing can cause discomfort of varying intensity, which occasionally can be severe and preclude its continued use in conscious patients.
- Similarly, unavoidable skeletal muscle contraction might be troublesome in very sick patients and might limit continuous use to a few hours. Erythema or hyperemia of the skin under the hands-free therapy electrodes often occurs; this effect is usually enhanced along the perimeter of the electrode. This reddening should lessen substantially within 72 hours.
- There have been reports of burns under the anterior electrode when pacing adult patients with severely restricted blood flow to the skin. Prolonged pacing should be avoided in these cases and periodic inspection of the underlying skin is advised.
- There are reports of transient inhibition of spontaneous respiration in unconscious patients with previously available units when the anterior electrode was placed too low on the abdomen.
- The pacing rate determination can be adversely affected by artifact. If the patient's pulse and the heart rate display are significantly different, external pacing pulses may not be delivered when required.
- Artifact and ECG noise can make R-wave detection unreliable, affecting the HR meter and the demand mode pacing rate. Always observe the patient closely during pacing operations. Consider using asynchronous pacing mode if a reliable ECG trace is unobtainable.
- Transcutaneous pacing should not be used to treat V FIB (ventricular fibrillation). In cases of V-FIB, immediate defibrillation is advised.
- Transcutaneous pacing may cause discomfort ranging from mild to severe, depending on the patient's tolerance level, muscle contractions and electrode placement. In certain cases, discomfort may be decreased by slightly relocating the pacing pads.
- It is important to monitor the patient closely to verify that both mechanical and electrical capture are occurring. Electrical capture can be verified by observing the presence of a large ectopic beat after the pacing pulse is delivered. The size and morphology of the beat are dependent on the patient. In some instances the beat may appear as a relatively normal looking QRS pulse. Mechanical capture can be verified by checking for signs of increased blood flow i.e., reddening of the skin, palpable pulses, increased blood pressure, etc. Continuously observe the patient during pacing administration, to insure capture retention. Do not leave the patient unattended when administering external pacing therapy.

---

**Warning!** This device can only be used for external pacing of patients and cannot be used for internal pacing. Do not connect internal pacing lead wires to the X Series defibrillator.

---

## CPR

- Place the patient on a firm surface before performing CPR.
- The patient must be motionless during CPR for accurate CPR measurements.

## Pulse Oximeter

- Keep the ZOLL finger probe clean and dry.
- SpO<sub>2</sub> measurements may be affected by certain patient conditions: severe right heart failure, tricuspid regurgitation or obstructed venous return.
- SpO<sub>2</sub> measurements may be affected when using intravascular dyes, in extreme vasoconstriction or hypovolemia or under conditions where there is no pulsating arterial vascular bed.
- SpO<sub>2</sub> measurements may be affected in the presence of strong EMI fields, electrosurgical devices, IR lamps, bright lights, improperly applied sensors; the use of non-ZOLL sensors, or damaged sensors; in patients with smoke inhalation, or carbon monoxide poisoning, or with patient movement.
- Tissue damage can result if sensors are applied incorrectly, or left in the same location for an extended period of time. Move sensor every 4 hours to reduce possibility of tissue damage.
- Do not use any oximetry sensors during MRI scanning. MRI procedures can cause conducted current to flow through the sensors, causing patient burns.
- Do not apply SpO<sub>2</sub> sensor to the same limb that has an NIBP cuff. The SpO<sub>2</sub> alarm may sound when the arterial circulation is cut off during NIBP measurements, and may affect SpO<sub>2</sub> measurements.
- In some instances, such as obstructed airway, the patient's breathing attempts may not produce any air exchange. These breathing attempts can still produce chest size changes, creating impedance changes, which can be detected by the respiration detector. It is best to use the pulse oximeter whenever monitoring respirations, to accurately depict the patient's respiratory condition.

## Noninvasive Blood Pressure

- Only a physician can interpret pressure measurements.
- Blood pressure measurement results may be affected by the position of the patient, his or her physiological condition and other factors.
- Substitution of a component different from that supplied by ZOLL (e.g., cuff, hoses, etc.) may result in measurement error. Use only ZOLL-approved cuffs and hoses. To avoid the risk of intravenous line misconnection and possible introduction of air into a patient's blood, do not modify the NIBP system or hoses with Luer Lock adapters.
- Do not use a blood pressure cuff on the limb being used for IV infusion or for SpO<sub>2</sub> monitoring.
- Accurate pressure readings may not be achieved on a person experiencing arrhythmias, shaking, convulsions or seizures. Medication may also affect pressure readings. The correct size cuff is essential for accurate blood pressure readings.
- Blood pressure hoses must be free of obstructions and crimps.
- If the patient's cuff is not at heart level, an error in measurement may result.
- When monitoring blood pressure at frequent intervals, observe the cuffed extremity of the patient for signs of impeded blood flow.
- Do not monitor one patient's NIBP while monitoring another patient's ECG.
- Blood pressure measurement may be inaccurate if taken while accelerating or decelerating in a moving vehicle.



- 
- If an NIBP measurement result is questionable or “motion” indication is displayed, repeat the measurement. If the repeated measurement result is still questionable, use another blood pressure measurement method.
  - Do not use the NIBP on cardiopulmonary bypass patients.

## IBP

- To ensure compatibility and electrical safety, accessory pressure sensors should comply with ANSI/AAMI BP-22 and IEC 60601-2-34 for IBP or ANSI/AAMI NS28 for ICP.
- Follow instructions supplied with any accessory pressure sensor regarding calibration and removal of trapped air.
- Avoid touching metal parts of any transducer while it is in contact with the patient.
- Do not reuse any components that are labeled for single use only.
- Transducers should be rated to withstand an accidental drop of at least a meter onto a hard surface.
- Transducers that are subject to immersion in liquids should be rated as watertight.

## CO<sub>2</sub>

- During MRI scanning, the monitor must be placed outside the MRI suite. When the monitor is used outside the MRI suite, EtCO<sub>2</sub> monitoring can be implemented using a long FilterLine<sup>®</sup> which permits placement of the monitor outside the MRI suite.
- When using the monitor with anesthetics, nitrous oxide or high concentrations of oxygen, connect the gas outlet to a scavenger system.
- Use only Oridion Microstream CO<sub>2</sub> sampling lines.
- Microstream CO<sub>2</sub> sampling lines are labeled for single patient use only. Do not reuse sampling lines.
- If using the CO<sub>2</sub> Monitor for extended critical care, replace the airway adapter every 24 hours or when it becomes occluded.
- CO<sub>2</sub> readings and respiratory rate can be affected by sensor application errors, certain ambient environmental conditions, and certain patient conditions.

## Respiration

- When using impedance pneumography, do not use the X Series unit with another respiration monitor that also uses impedance pneumography on the same patient. The respiration measurement signals may interfere with one another and could affect the respiration accuracy.
- Do not operate the X Series with any other monitor with respiration measurements on the same patient. The two devices could affect the respiration accuracy.
- The device should not be used as an apnea monitor.
- Do not solely rely on respiratory monitoring for detecting cessation of breathing. Follow hospital guidelines and best clinical practices, including monitoring additional parameters that indicate the patient’s oxygenation status.
- The use of end tidal CO<sub>2</sub> monitoring is always recommended when respiratory monitoring is required in neonates. Respiratory monitoring using the impedance pneumography has not been clinically validated in this patient population.
- The No Breath alarm should not be used or relied upon while the patient is unattended.

## Ferromagnetic Equipment

Biomedical equipment and accessories, such as ECG electrodes, cables, and oximeter probes contain ferromagnetic materials. Ferromagnetic equipment must not be used in the presence of high magnetic fields created by magnetic resonance imaging (MRI) equipment.

The large magnetic fields generated by an MRI device can attract ferromagnetic equipment with an extremely violent force, which could cause serious personal injury or death to persons between the equipment and the MRI device.

## Battery

- Although the device can operate with auxiliary power alone, ZOLL strongly recommends that you operate the unit with a battery installed at all times. Operating the unit with a battery provides a backup in case of AC power shortage, and results in faster charge time. The battery can be automatically recharged while it is installed in the unit. Keep a fully charged spare battery pack with the defibrillator at all times.
- Test battery packs regularly. A battery that does not pass the ZOLL charger's capacity test might cause the X Series unit to shut down unexpectedly.
- If the Low Battery indication occurs at any time during operation, immediately replace the battery pack.
- If the *LOW BATTERY* icon appears, plug the X Series unit into a power source or install a fully charged battery pack. When the warning low battery shutdown prompt appears, immediately replace the battery pack with a fully charged pack or plug the X Series unit into a power source, as unit shut down due to a low battery condition is imminent.
- If mistreated, a battery pack might explode. Do not disassemble a battery pack or dispose of it in fire.

## Operator Safety



- The X Series can deliver 200 joules of electrical energy. If this electrical energy is not discharged properly, as described in this manual, the electrical energy could cause personal injury or death to the operator or bystanders.
- Do not use the X Series in the presence of oxygen-rich atmospheres, flammable anesthetics, or other flammable agents (such as gasoline). Using the unit in such environments might cause an explosion.
- Do not use the unit near or within standing water. Electrical safety might be compromised when the defibrillator is wet.
- Never discharge the unit with the defibrillation electrodes or paddles shorted together or in open air.
- Do not discharge the defibrillator except as indicated in the instructions. Discharge the defibrillator only when defibrillation electrodes or paddles are properly applied to the patient.
- To avoid risk of electric shock, this equipment must only be connected to AC mains with protective earth
- To avoid risk of electrical shock, do not touch the gelled area of the hands-free therapy electrodes during pacing or defibrillation.
- To avoid risk of electrical shock, do not allow electrolyte gel to accumulate on hands or paddle handles.
- To avoid risk of electrical shock, do not allow patient connectors to contact other conductive parts, including earth.
- For defibrillation using paddles, use only high-conductivity electrolyte gel specified for such use by the manufacturer.

- When using paddles for defibrillation, use your thumbs to operate the **SHOCK** buttons. Doing so avoids inadvertent shock to the operator.
- The use of accessory equipment that does not comply with the equivalent safety requirements of the X Series defibrillator could reduce the level of safety of the combined system. When choosing accessory equipment, consider the following:
  - Use of the accessory in the patient vicinity.
  - Evidence that the safety certification of the accessory has been performed in accordance with the appropriate IEC (EN) 60601-1 and/or IEC (EN) 60601-1-1 harmonized national standards.
- Always check that the equipment functions properly and is in proper condition before use.
- Disconnect all electro-medical equipment that is not defibrillation-protected from the patient prior to defibrillation.
- Before discharging the defibrillator, warn everyone to **STAND CLEAR** of the patient.
- Do not touch the bed, patient, or any equipment connected to the patient during defibrillation. A severe shock can result. To avoid hazardous pathways for the defibrillation current, do not allow exposed portions of the patient's body to touch any metal objects, such as a bed frame.
- To avoid risk of electrical shock, do not allow printer to come into contact with other conductive parts, such as equipment connected to the USB port.

## Patient Safety



- Inappropriate defibrillation or cardioversion of a patient (for example, with no malignant arrhythmia) may precipitate ventricular fibrillation, asystole, or other dangerous arrhythmias.
- Defibrillation without proper application of electrodes or paddle electrolyte gel might be ineffective and cause burns, particularly when repeated shocks are necessary. Erythema or hyperemia of the skin under the paddles, or electrodes often occurs; this effect is usually enhanced along the perimeter of the paddles or electrodes. This reddening should diminish substantially within 72 hours.
- This equipment should be connected to only one patient at a time.
- Use only OneStep Pediatric electrodes to defibrillate patients under 8 years of age. Use of adult electrodes, or pediatric electrodes other than OneStep Pediatric electrodes, can result in the delivery of excessive energy doses.
- Neonatal and pediatric defibrillation energy level settings should be based on site-specific clinical protocols.
- To ensure patient safety, do not place the monitor in any position that might cause it to fall on the patient.
- To ensure patient safety, connect the X Series only to equipment with circuits that are electrically isolated.
- Use only high-quality ECG electrodes. ECG electrodes are for rhythm acquisition only; you cannot use ECG electrodes for defibrillation or pacing.
- Do not use therapy or ECG electrodes if the gel is dried, separated, torn or split from the foil; patient burns may result from using such electrodes. Poor adherence and/or air pockets under therapy electrodes can cause arcing and skin burns.
- Check the expiration date on the electrode packaging. Do not use electrodes after their expiration date.
- Excessive body hair or wet, diaphoretic skin can inhibit electrode coupling to the skin. Clip excess hair and dry any moisture from the area where an electrode is to be attached.
- Therapy electrodes should be replaced periodically during continuous pacing. Consult electrode directions for proper replacement instructions.
- Prolonged pacing (more than 30 minutes), particularly in neonates or adults with severely restricted blood flow, may cause burns. Periodically inspect the skin under the electrodes.
- Carefully route the patient cables away from the patient's neck to reduce the possibility of patient entanglement or strangulation.

- To avoid electrosurgery burns at monitoring sites, ensure proper connection of the electrosurgery return circuit so that a return path cannot be made through monitoring electrodes or probes.
- During electrosurgery, observe the following guidelines to minimize electrosurgery unit (ESU) interference and provide maximum operator and patient safety:
  - Keep all patient monitoring cables away from earth ground, ESU knives, and ESU return wires.
  - Use electrosurgical grounding pads with the largest practical contact area.
- Always ensure proper application of the electrosurgical return electrode to the patient.
- Check electrical leakage levels before use. Leakage current might be excessive if more than one monitor or other piece of equipment is connected to the patient.

## Cautions

- If the unit is to be stored longer than 30 days, remove the battery pack.
- Do not sterilize the defibrillator, or its accessories unless the accessories are labeled as sterilizable.
- Do not immerse any part of the defibrillator in water.
- Do not use the defibrillator if excessive condensation is visible on the device. Wipe only the outside with a damp cloth.
- Do not use ketones (such as acetone or MEK) on the defibrillator.
- Avoid using abrasives (including paper towels) on the display window.
- To achieve the specified level of protection against spilled or splashed liquids, thoroughly dry all exposed surfaces of this device prior to operation or connections to auxiliary power.
- If liquids enter the device connectors, remove all liquid from the connectors and allow the device to dry thoroughly prior to use.
- Grounding reliability can be achieved only when the equipment is connected to a receptacle marked “HOSPITAL ONLY,” “HOSPITAL GRADE,” or equivalent. If the grounding integrity of the line cord or ac receptacle is questionable, operate the defibrillator using battery power only.
- Do not connect to an electrical outlet controlled by a wall switch or dimmer.
- To protect the unit from damage during defibrillation, for accurate ECG information, and to protect against noise and other interference, use only internal current-limiting ECG cables specified or supplied by ZOLL.
- For continued safety and EMI performance, use only the line cord supplied by ZOLL.
- Electrical installation of the room or the building in which the monitor is to be used must comply with regulations specified by the country in which the equipment is to be used.
- Dispose of battery packs in accordance with national, regional and local regulations. Battery packs should be shipped to a reclamation facility for recovery of metal and plastic compounds as the proper method of waste management.
- Do not place the device where the controls can be changed by the patient.
- Use in aircraft can cause interference with IBP monitoring.
- CO<sub>2</sub> readings may be affected by the presence of RF transmitters. See “Electromagnetic Compatibility Guidance and Manufacturer’s Declaration” on page A-32.

## Restarting the Defibrillator

Certain events require the X Series products to be restarted after they shut off or become inoperative (for example, when the battery runs down and the unit shuts off).

In such a case, always try to restore defibrillator operation as follows:

1. Press the power switch on the top of the unit to turn it off.
2. If necessary, replace a depleted battery with a fully charged pack, or connect the defibrillator to auxiliary power.
3. Press the power switch on the top of the unit to turn it back on.

This sequence is necessary to restart the defibrillator and can also be used to clear some fault messages when immediate use of the defibrillator is required.

If the X Series unit is powered off for less than 2 minutes, all patient monitoring parameter settings will be retained. If the unit has been powered off for at least two minutes, it will be considered a New Patient and all of the patient-specific parameters (alarm limits, defibrillator energy, etc.) will be reset to their default values.

## FDA Tracking Requirements

U.S. Federal Law (21 CFR 821) requires the tracking of defibrillators. Under this law, owners of this defibrillator must notify ZOLL Medical Corporation if this product is

- received
- lost, stolen, or destroyed
- donated, resold, or otherwise distributed to a different organization

If any such event occurs, contact ZOLL Medical Corporation in writing with the following information:

1. Originator's organization – Company name, address, contact name, and contact phone number
2. Model number, and serial number of the defibrillator
3. Disposition of the defibrillator (for example, received, lost, stolen, destroyed, distributed to another organization), new location and/or organization (if known and different from originator's organization) – company name, address, contact name, and contact phone number
4. Date when the change took effect

Please address the information to:

**ZOLL Medical Corporation**  
**Attn: Tracking Coordinator**  
**269 Mill Road**  
**Chelmsford, MA 01824-4105**

Fax: +1-978-421-0025

Telephone: +1-978-421-9655

## Notification of Adverse Events

As a health care provider, you may have responsibilities under the Safe Medical Devices Act (SMDA), for reporting to ZOLL Medical Corporation, and possibly to the FDA, the occurrence of certain events.

These events, described in 21 CFR Part 803, include device-related death and serious injury or illness. In addition, as part of our Quality Assurance Program, ZOLL Medical Corporation requests to be notified of device failures or malfunctions. This information is required to ensure that ZOLL Medical Corporation provides only the highest quality products.

## Software License

**Note:** Read this Operator's Guide and License agreement carefully before operating any of the X Series products.

Software incorporated into the system is protected by copyright laws and international copyright treaties as well as other intellectual property laws and treaties. This software is licensed, not sold. By taking delivery of and using this system, the Purchaser signifies agreement to and acceptance of the following terms and conditions:

1. **Grant of License:** In consideration of payment of the software license fee which is part of the price paid for this product ZOLL Medical Corporation grants the Purchaser a non-exclusive license, without right to sublicense, to use the system software in object-code form only.
2. **Ownership of Software/Firmware:** Title to, ownership of and all rights and interests in the system software and all copies thereof remain at all times vested in the manufacturer, and Licensors to ZOLL Medical Corporation and they do not pass to purchaser.
3. **Assignment:** Purchaser agrees not to assign, sublicense or otherwise transfer or share its rights under the license without the express written permission of ZOLL Medical Corporation.
4. **Use Restrictions:** As the Purchaser, you may physically transfer the products from one location to another provided that the software/firmware is not copied. You may not disclose, publish, translate, release or distribute copies of the software/firmware to others. You may not modify, adapt, translate, reverse engineer, decompile, crosscompile, disassemble or create derivative works based on the software/firmware.

### NO IMPLIED LICENSE

Possession or purchase of this device does not convey any express or implied license to use the device with replacement parts which would, alone, or in combination with this device, fall within the scope of one or more of the patents relating to this device.

## Service

The X Series only requires recalibration of the CO<sub>2</sub> module. Service is required after 20,000 hours of use of the CO<sub>2</sub> module. Appropriately trained and qualified personnel should, however, perform periodic tests of the defibrillator functionality to verify proper operation.

If a unit requires service, contact the ZOLL Technical Service Department.

For customers In the U.S.A.		For customers outside the U.S.A.
Telephone:	1-800-348-9011 1-978-421-9655	Call the nearest authorized ZOLL Medical Corporation representative.
Fax:	1-978-421-0010	To locate an authorized service center, contact the International Sales Department at  ZOLL Medical Corporation 269 Mill Road Chelmsford, MA 01824-4105 Telephone: 1-978-421-9655

When requesting service, please provide the following information to the service representative:

- Unit serial number
- Description of the problem
- Department using the equipment and name of the person to contact
- Purchase order to allow tracking of loan equipment
- Purchase order for a unit with an expired warranty
- Sample ECG or other stripcharts demonstrating the problem (if available and applicable), less any confidential patient information.

### Returning a unit for service

Before sending a unit to the ZOLL Technical Service Department for repair, obtain a service request (SR) number from the service representative.

Remove the battery pack from the unit. Pack the unit with its cables and battery in the original containers (if available) or equivalent packaging. Be sure the assigned service request number appears on each package.

For customers	Return the unit to
In the U.S.A.	ZOLL Medical Corporation 269 Mill Road Chelmsford, MA 01824-4105  Attention: Technical Service Department ( <i>SR number</i> )  Telephone: 1-800-348-9011
In Canada	ZOLL Medical Canada Inc. 1750 Sismet Road, Unit #1 Mississauga, ON L4W 1R6  Attention: Technical Service Department ( <i>SR number</i> )  Telephone: 1-866-442-1011
In other locations	The nearest authorized ZOLL Medical Corporation representative. To locate an authorized service center, contact the International Sales Department at  ZOLL Medical Corporation 269 Mill Road Chelmsford, MA 01824-4105  Telephone: 1-978-421-9655

## The ZOLL Serial Number

Each ZOLL product displays a serial number that contains information about that product. From left to right, ZOLL serial numbers are structured as follows:

- A two-character product code
- A three-character date-of-manufacture code
- A product serial number of six or more alphanumeric characters

The first two characters of the date-of-manufacture code give the last two digits of the year (for example, “06” appears for products manufactured in 2006). The last character of the date-of-manufacture code gives the month in which the product was manufactured. The month appears in the form of a single alphanumeric character: “A” for January, “B” for February, “C” for March, and so on through “L” for December.

The product serial number is a unique set of alphanumeric characters that ZOLL assigns to each individual unit.

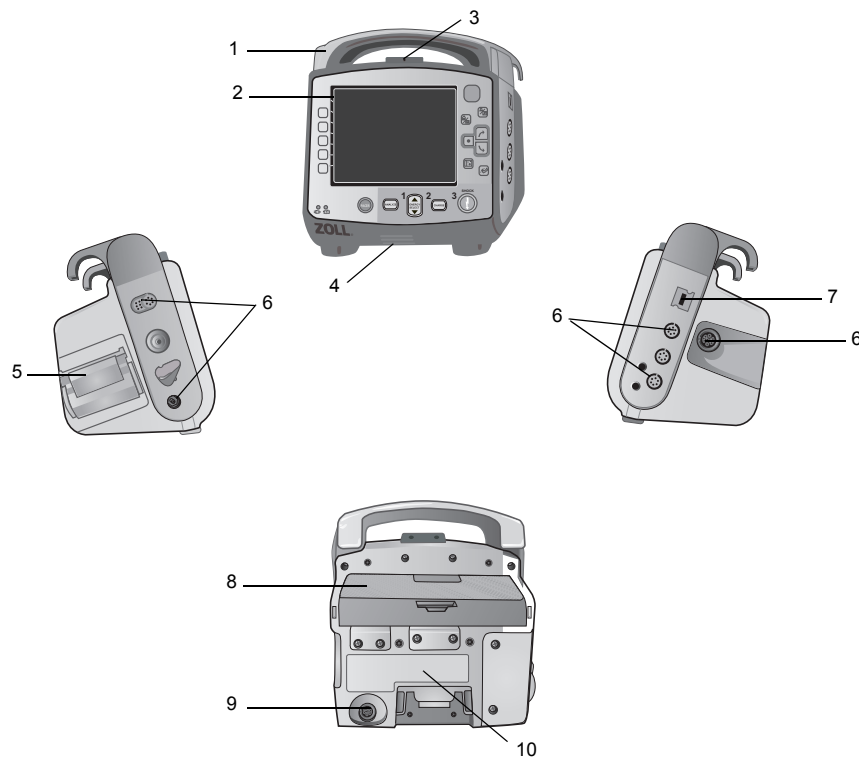


# Chapter 2

## Product Overview

---

### Defibrillator Controls and Indicators

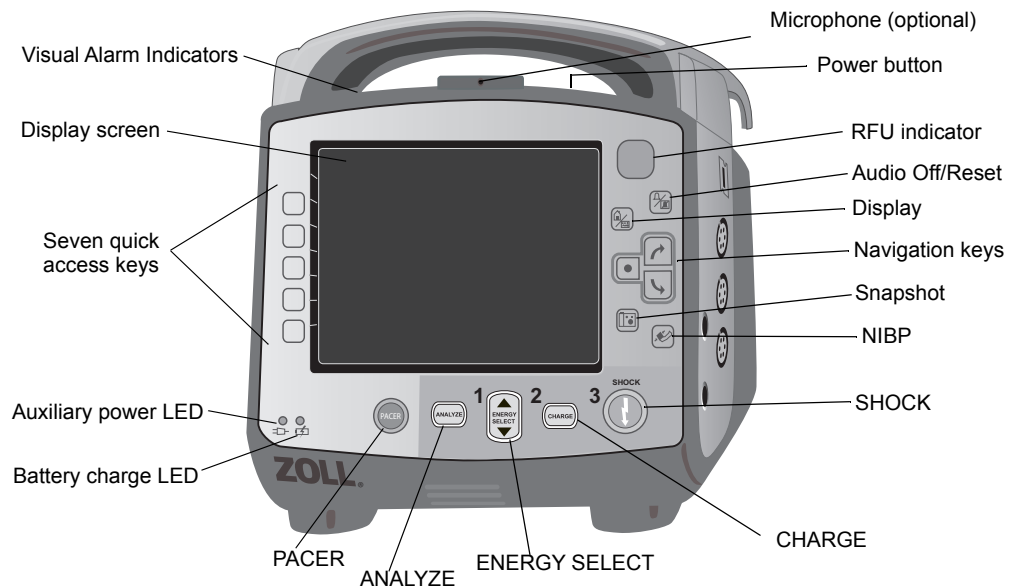


**Table 1: X Series Unit Features**

	Item	Description
1	Handle	Integrated carrying handle.
2	Front panel	Includes the display screen and primary controls.
3	Microphone (optional)	Records audio activity in the vicinity of the X Series unit.
4	Speaker	Emits R-wave detection beeps and alarm tones.
5	Paper Compartment	Holds the paper for the printer.
6	Patient connectors	For details, refer to “Patient Cables and Connectors” on page 2-7.
7	USB device connector	For connecting the X Series defibrillator to a USB device. For details, refer to “Transferring Data to a USB Device” on page 21-4.”
8	Battery compartment	Holds a rechargeable lithium ion battery pack.
9	Auxiliary power connector	For connecting the device to an auxiliary power adapter.
10	Dock connector	For connecting the device to a docking station.








## The Front Panel

The front panel of the X Series device includes the display screen, quick access keys, battery and auxiliary power indicators, Ready For Use (RFU) indicator, and the defibrillation front panel buttons: **PACER**, **ANALYZE**, **ENERGY SELECT**, **CHARGE**, and **SHOCK** (ⓘ). See Figure 2-1. Refer to Table 2 on page 2-3 for information about the controls and indicators.









**Figure 2-1 X Series Front Panel**

**Table 2: X Series Controls and Indicators**

Control or Indicator	Description
Display screen	Shows therapeutic settings, physiological waveforms and other information for each monitored parameter, messages, time, and quick access key labels.
Quick access keys	Seven buttons control different functions of the unit. Labels for the quick access keys appear on the monitor display to the right of each key.
Auxiliary power LED	Illuminated when the unit is plugged in to an auxiliary power adapter.
Battery charge LED	Indicates battery status. Steady yellow: Battery is charging. Steady green: Battery is charged. Alternating green and yellow: The charge state cannot be determined or a battery charging fault has been detected. No light: Battery is not installed.
Visual alarm indicators	Red, yellow, and green lights located on the top of the unit that flash on and off when the unit is powered up and are used to indicate a patient alert, equipment alert, and data transfer.
<b>PACER</b> button 	Displays pacer settings window to start/stop pacing activity or change the rate, output, or mode settings.
<b>ANALYZE</b> button 	Displays in Manual mode only. Initiates ECG analysis to determine whether or not a shockable rhythm is present.
<b>ENERGY SELECT</b> buttons 	Two sets of up-down arrow buttons control the selection of defibrillator energy; one set is located on the front panel and the other set is located on the STERNUM paddle.
<b>CHARGE</b> Button 	Charges the defibrillator to the selected energy. In addition to the <b>CHARGE</b> button on the front panel, there is one located on the APEX paddle handle.
<b>SHOCK</b> Button 	The front panel <b>SHOCK</b> button is only active when using hands-free therapy electrodes or internal defibrillation paddles without a discharge button. The <b>SHOCK</b> button illuminates when the device is charged and ready.  To discharge the defibrillator when using paddles (internal or external) with discharge buttons, press and hold the <b>SHOCK</b> buttons on the paddles.
<b>NIBP</b> button 	Starts/stops an NIBP measurement.
<b>Snapshot</b> button 	Records 24 seconds of numeric and waveform data.

**Table 2: X Series Controls and Indicators (Continued)**

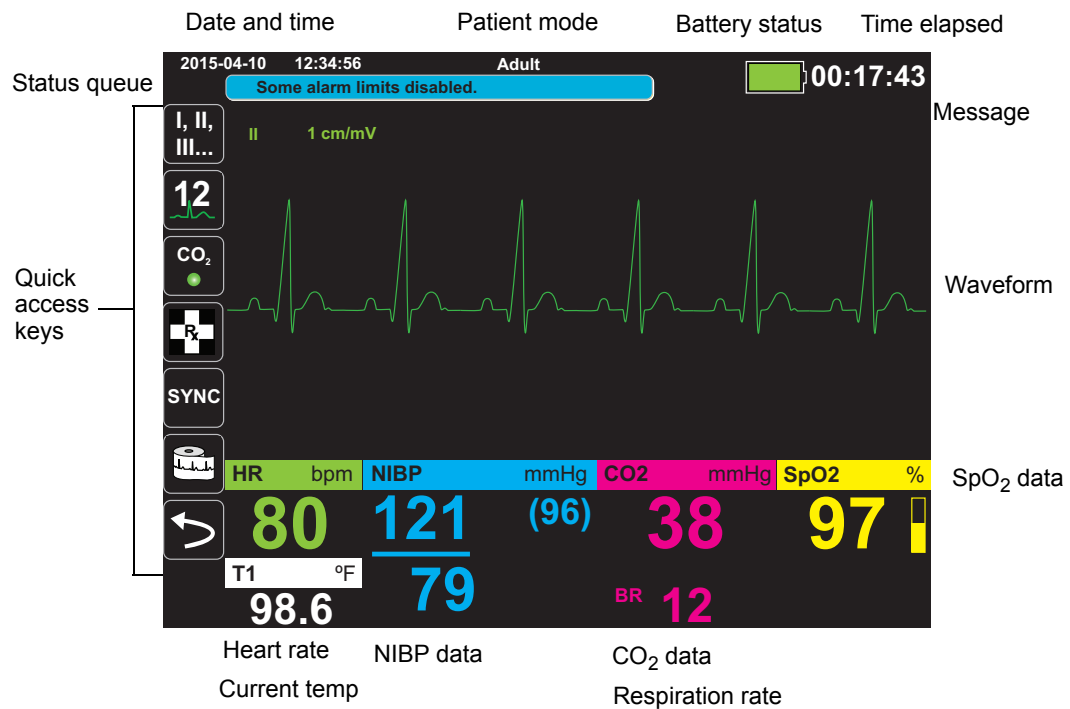
Control or Indicator	Description
Navigation keys 	 The up (clockwise) arrow will cause the cursor to travel in an upward direction if the cursor is being used to navigate through a vertical list or in a clockwise direction if the cursor is being used to navigate around the full screen. Likewise, the down (counterclockwise) arrow will cause the cursor to travel in a downward direction if the cursor is being used to navigate through a vertical list or in a counterclockwise direction if the cursor is being used to navigate around the full screen. The up (clockwise) and down (counterclockwise) arrows may also be used to modify parameter settings.  <input type="checkbox"/> The Select button acts based on what is highlighted.
Display/Home button 	Cycles through three available display modes or functions as a Home button when in a menu.
Audio Pause (Silence)/Reset button 	Use to acknowledge a current alarm and pause (silence) the alarm audio for 90 seconds.  Pressing <b>Audio Pause (Silence)/Reset</b> button before the Audio Pause (Silence) period has expired resets the alarm.
Ready for Use Indicator 	Shows the status of the unit, based on its most recent readiness check.  A red circle with a line through it indicates that the unit's readiness has been compromised and that it may not be ready for therapeutic use.
Power button 	Located on the top of the unit, this button turns the unit on and off. <b>Note:</b> The X Series unit may display the message <i>Check Sensor or searching...</i> when the unit is powered on, but the SpO2 sensor has not yet been connected to the patient. If SpO2 monitoring is desired, connect the SpO2 sensor to the patient. See Chapter 10, "Pulse CO-Oximetry (SpO2)" for information on SpO2 monitoring.
Microphone (optional)	Records audio activity in the vicinity of the X Series unit.
Charge Indicator Light (not shown)	Located on the APEX paddle, this light turns on when the defibrillator is charged and ready.

## Display Screen

The front panel includes a color display which shows:

- Date and time
- Patient mode
- Battery status indicator
- Time elapsed (since unit was turned on)
- Quick access keys
- Waveform source
- Color-coded waveforms and ECG lead identifiers
- SpO<sub>2</sub> numeric data
- Heart rate numeric data
- Respiration rate numeric data
- Temperature numeric data
- Non-invasive blood pressure numeric data
- EtCO<sub>2</sub> numeric data
- Invasive pressure numeric data
- The selected energy, charging status, and delivered energy for defibrillation and synchronized cardioversion
- The output current and stimulus rate for pacing
- Messages and prompts

Figure 2-2 shows the layout of parameter values, waveforms, system data, and quick access key labels.



**Figure 2-2 X Series Display Screen**











### Color coding

To differentiate information for various parameters, the unit displays each type of information in a specific user-configurable color.

## Battery Status and Auxiliary Power Indicators

The battery status indicator displays various battery icons to indicate the approximate remaining unit run time based on the charged state of the battery. Additionally, these icons provide indications of the status of the battery connection and communication with the unit. The auxiliary power indicator indicates that the unit is being powered by the auxiliary power adapter.

**Note:** Upon powering up the X Series unit, the battery capacity will be displayed within approximately 15 seconds under normal conditions. Under some circumstances, such as activating the defibrillator immediately after the unit is turned on, the battery icon may display less than one hour battery capacity for up to two minutes after exiting the defibrillation mode.

Icon	Status	Indication/Action
	Auxiliary power adapter is connected	The unit is being powered by the auxiliary power adapter.
	No battery detected	Either there is no battery in the unit while it is being powered by the auxiliary power adapter, or the device cannot detect that the battery is connected.
	Low battery capacity	Replace the battery soon.
	Communication failure	The unit is unable to establish communication with the battery and the battery capacity is unknown. Check the battery contacts.
	Battery fault	A battery fault has been detected. Replace the battery.
	Battery Level 1	The battery has less than one hour of remaining battery capacity.
	Battery Level 2	The battery has greater than one hour of remaining battery capacity.
	Battery Level 3	The battery has greater than two hours of remaining battery capacity.
	Battery Level 4	The battery has greater than three hours of remaining battery capacity.
	Battery Level 5	The battery is fully charged.

## Patient Cables and Connectors

The left and right sides of the unit include sets of connectors for patient cables.

**Note:** The SpO<sub>2</sub>, NIBP, CO<sub>2</sub>, Temperature, and IBP functions are optional. If your unit does not include these options, it does not have the applicable connectors.

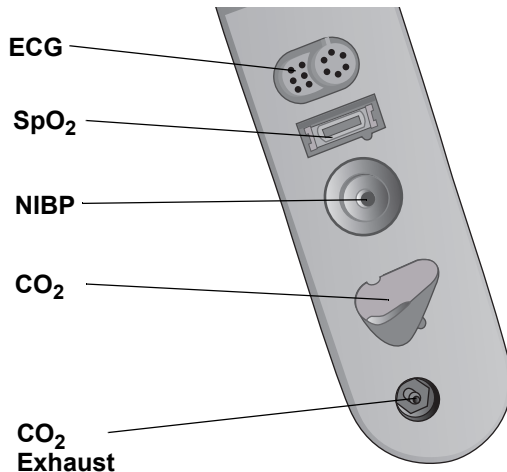


Figure 2-3 Patient Cable Connectors on Left Side of Unit

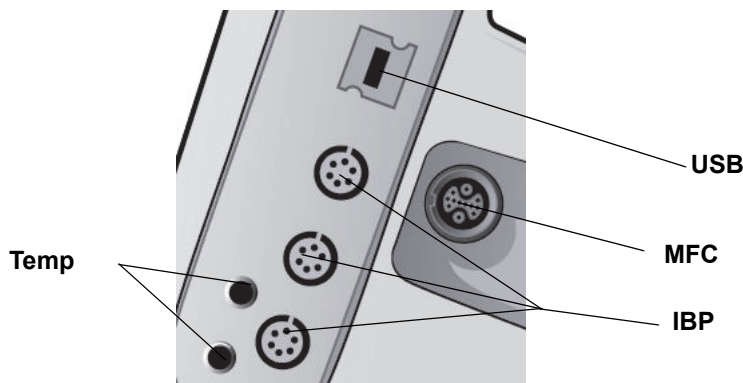


Figure 2-4 Patient Cable Connectors on Right Side of Unit

Connector	Description
ECG	For connecting 3- or 5-lead ECG cable (12-lead monitoring is optional).
SpO <sub>2</sub>	For connecting Masimo SpO <sub>2</sub> /CO cable.
NIBP	For connecting NIBP hose.
CO <sub>2</sub>	For connecting CO <sub>2</sub> sampling line.
Temp	For connecting temperature probe(s).
Multifunction Cable (MFC)	For connecting paddles or ZOLL hands-free therapy and pacing electrodes.
USB	For connecting the X Series defibrillator to a USB device.
IBP	For connecting IBP cable(s).

### Multifunction Cable (MFC)

The unit ships with an MFC that is used to defibrillate the patient. Any other cables that ship with your unit depend on the options you have purchased. See “ZOLL Cables and Compatible Accessories” on page 2-10 for a list of compatible accessories.

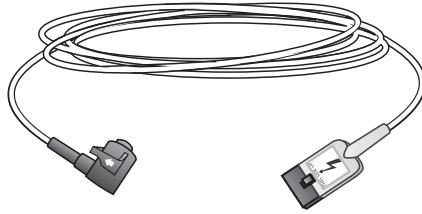
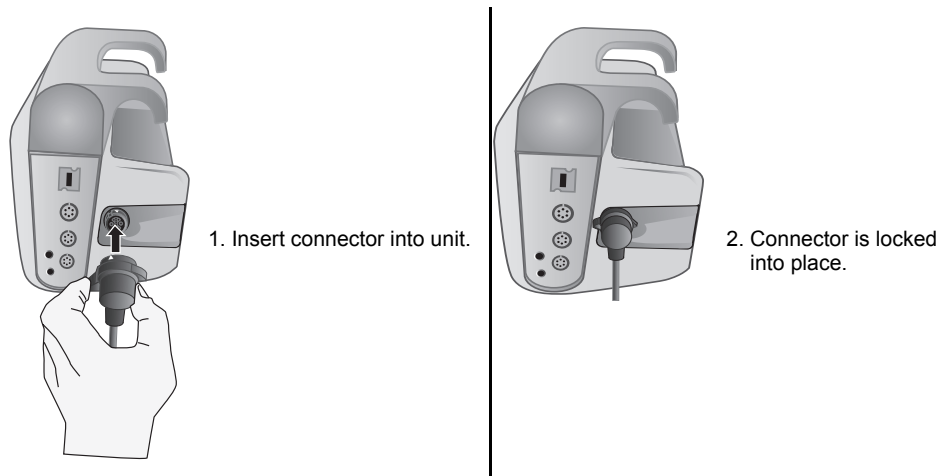


Figure 2-5 MFC

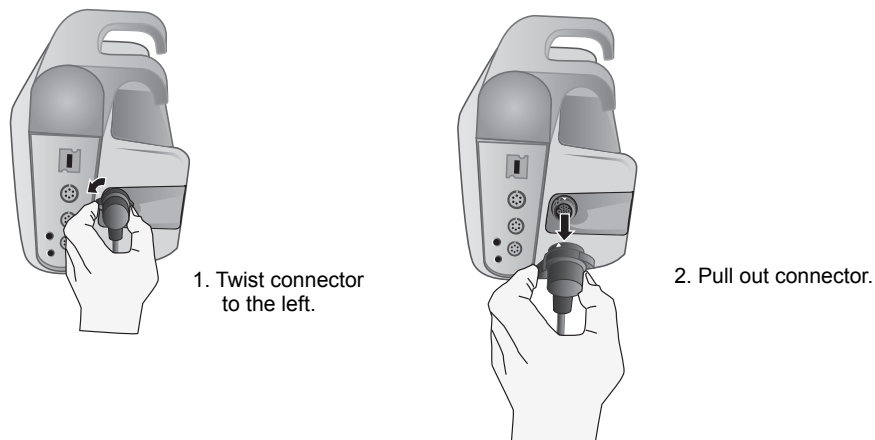
### Inserting Cables into Unit

Plug the cable connector into the therapy input connector on the right side of the unit. Push the connector in with the arrows aligned. The connector will click when it locks into place.



### Removing Cables from Unit

Twist the connector to the left to unlock it, and pull out the cable connector.





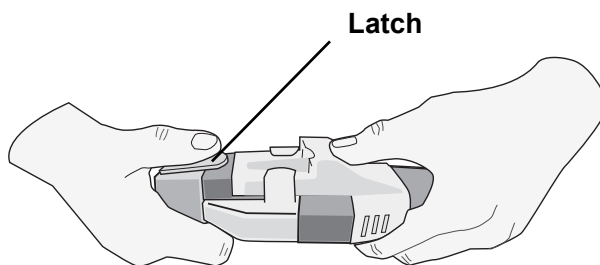
### OneStep Cable (optional)

The OneStep™ cable is used with OneStep electrodes for ECG monitoring and for use with Real CPR Help. See “ZOLL Cables and Compatible Accessories” on page 2-10 for a list of compatible accessories.

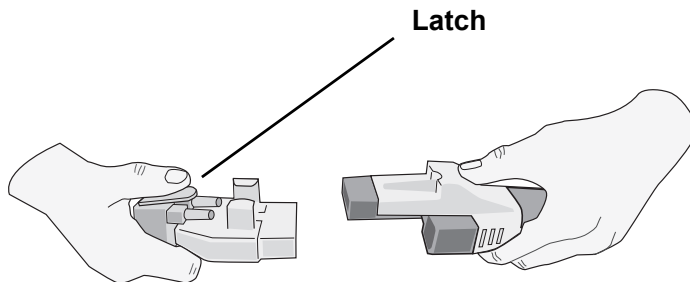


**Figure 2-6 OneStep Cable**

When connecting a OneStep electrode to the OneStep cable, push the two connectors together until the latch clicks, as shown.

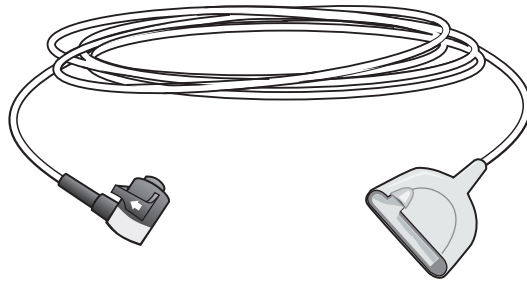


When disconnecting the OneStep electrode and OneStep cable, press down the latch with your thumb as shown.



**MFC with CPRD Connector (optional)**

The X Series with MFC with CPRD connector is used for ECG monitoring and for use with Real CPR Help. See the table below for a list of compatible accessories.



**ZOLL Cables and Compatible Accessories**

Cable Description	Internal Paddles	External Paddles	Stat-Padz	Pedi -Padz II	CPR-D Padz	CPR-Stat-Padz
MFC	√	√	√	√ With MFC - CPRD adapter	√ With MFC - CPRD adapter	√ With MFC - CPRD adapter
OneStep Cable	√	√	√			
MFC with CPRD Connector			√	√	√	√

## External Paddles



Paddles are defibrillation-proof Type BF equipment.

The external paddles on the X Series device are used for defibrillation and synchronized cardioversion.

---

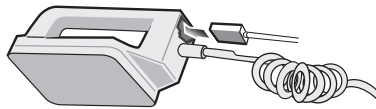
**Caution** You cannot use paddles for external transcutaneous pacing.

---

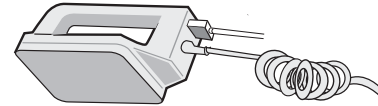
### Attaching the MFC cable

Attach the MFC from the X Series unit to the connector at the base of the APEX paddle.

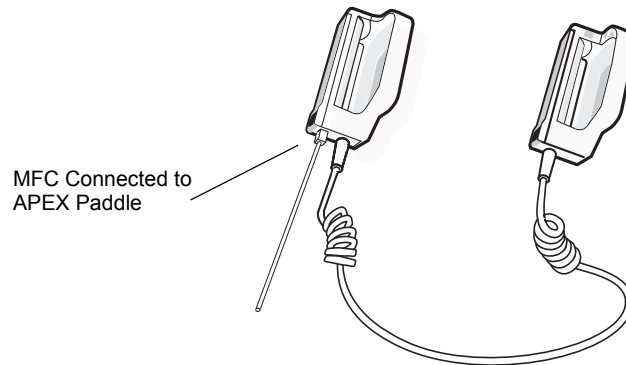
1. Align MFC as shown.



2. Insert MFC into APEX handle.



**Figure 2-7 Attaching the MFC to the APEX Paddle**

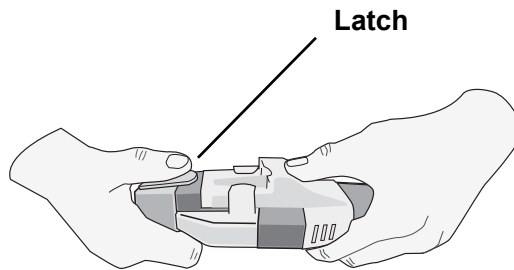


**Figure 2-8 MFC Connected to APEX Paddle**

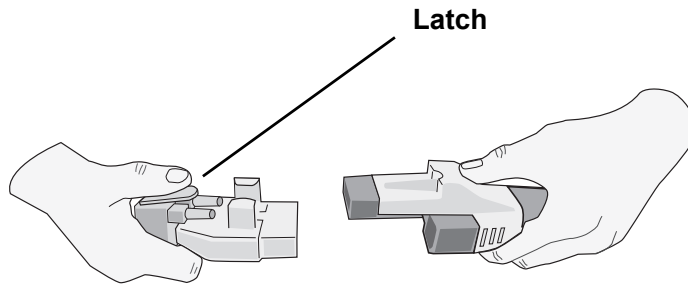
If you need to detach the MFC from the APEX paddles, push the **RELEASE** button (see Figure 2-11) in the direction of the arrow and unplug the MFC.

### Attaching the OneStep Cable

When connecting a OneStep electrode to the OneStep cable, push the two connectors together until the latch clicks, as shown.

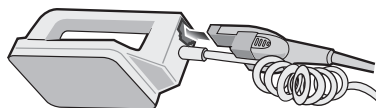


When disconnecting the OneStep electrode and OneStep cable, press down the latch with your thumb as shown.

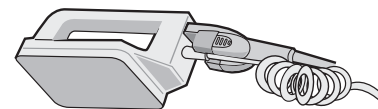


When attaching the OneStep cables to paddles, attach the OneStep cable from the X Series unit to the connector at the base of the apex paddle.

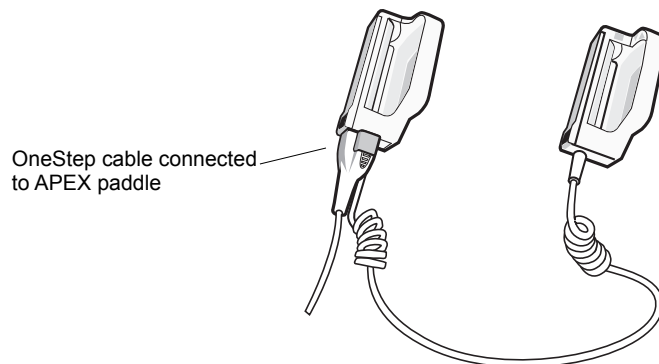
1. Align OneStep cable as shown.



2. Insert OneStep cable into APEX paddle.



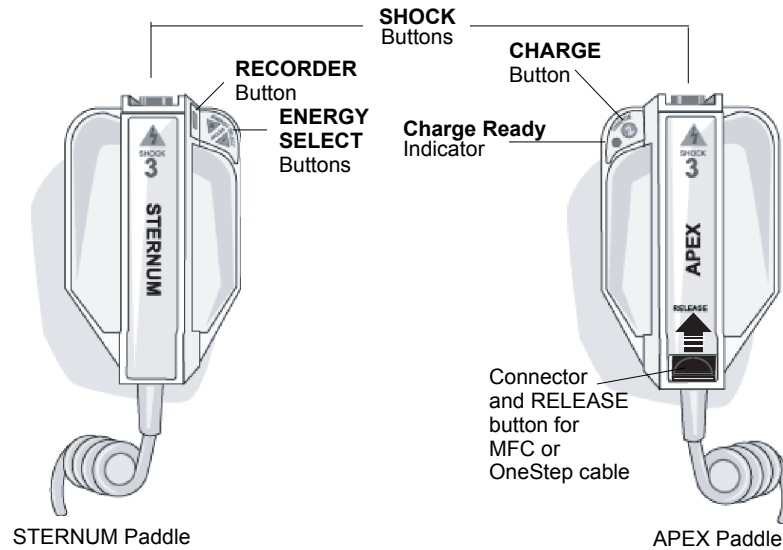
**Figure 2-9 Attaching the OneStep Cable to the APEX Paddle**



**Figure 2-10 OneStep Cable Connected to APEX Paddle**

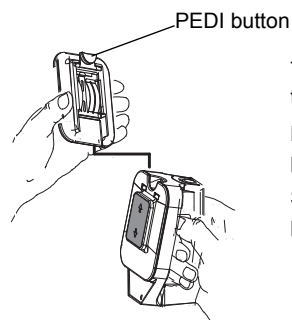
If you need to detach the OneStep cable from the APEX paddles, push the **RELEASE** button (see Figure 2-11) in the direction of the arrow and unplug the OneStep cable.

Refer to Chapter 15, "Manual Defibrillation" before using paddles for defibrillation. The paddles include controls for selecting defibrillation energy, charging, and delivering a shock.



**Figure 2-11 External Paddles**

Pediatric-size electrodes are built in to the paddle assembly beneath the standard electrode plates. The user must manually adjust energy settings to pediatric levels consistent with their institution's protocols.



To expose the pediatric plate, press the PEDI button at the top of the paddle, then slide the Adult plate upward.


Before replacing the Adult plate, be sure to clean the pediatric plate and surrounding area thoroughly.

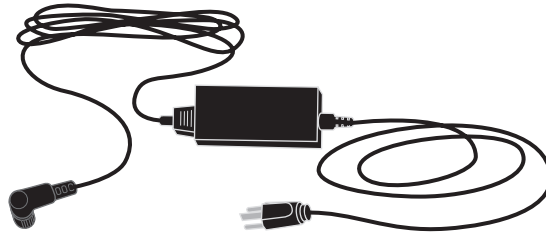
Slide the Adult plate onto the paddle until it locks into place.

**Figure 2-12 Pediatric Plate**

**Note:** The X Series defibrillator also supports ZOLL autoclavable internal handles for use during open chest defibrillation procedures.

## AC Auxiliary Power Adapter

The AC auxiliary power adapter is used as backup power to operate the X Series unit. When it is connected to the unit, it powers the unit and charges the battery that is installed inside it. When the power cord is plugged in and the auxiliary power connector is inserted into the back of the X Series unit, the auxiliary power LED on the front panel illuminates and the auxiliary power icon (  ) displays at the top of the display screen. See “Connecting the AC Auxiliary Power Adapter or DC Auxiliary Power Supply” on page 2-16 for instructions on connecting the adapter to the X Series unit.



**Figure 2-13 AC Auxiliary Power Adapter**

---

**Caution** To ensure continuous operation, always keep a battery installed in the device that is being powered by the AC Auxiliary Power Adapter.


---

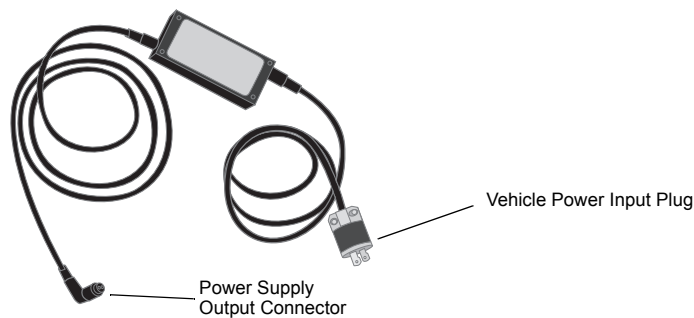
**Caution** Allow access to AC power cord as a means of disconnecting from AC mains power.

---

---

## DC Auxiliary Power Supply (optional)

The DC auxiliary power supply is used as backup power to operate the X Series unit. When it is connected to the unit, it powers the unit and charges the battery that is installed inside it. When the vehicle power input plug is connected to vehicle power and the power supply output connector is inserted into the back of the X Series device, the auxiliary power LED on the front panel illuminates and the auxiliary power icon (  ) displays at the top of the display screen.



**Figure 2-14 DC Auxiliary Power Supply**

---

**Warning!** Do not connect the DC Auxiliary Power Supply to any power source other than DC voltage, within the range 12-24 VDC.

**Do not perform any unauthorized modification to the DC Auxiliary Power Supply.**

---

**Caution** To prevent heat buildup while in use, place the DC Auxiliary Power Supply in a location that allows unrestricted air circulation.

When the DC Auxiliary Power Supply is in use, assess electromagnetic compatibility with surrounding devices.

To ensure continuous operation, always keep a battery installed in the device that is being powered by the DC Auxiliary Power Supply.

---

## Connecting the DC Auxiliary Power Supply to a Suitable Vehicle Power Source

Connect the input plug (Hubbell part number HBL7545C) of the DC Auxiliary Power Supply to the vehicle power source. When the input plug is connected to the vehicle, the brass blade (red wire) of the Hubbell connector connects to the DC positive (+) vehicle supply terminal, and the silver blade (black wire) connects to the DC negative (-) vehicle supply terminal.

## Connecting AC Auxiliary Power Adapter or DC Auxiliary Power Supply

To connect the AC auxiliary power adapter or the DC auxiliary power supply to the X Series unit, align the white arrow of the auxiliary power cable with the white dot on the input connector on the back of the unit and push it in. To disconnect the auxiliary power adapter/power supply, grasp the connector and pull it out.

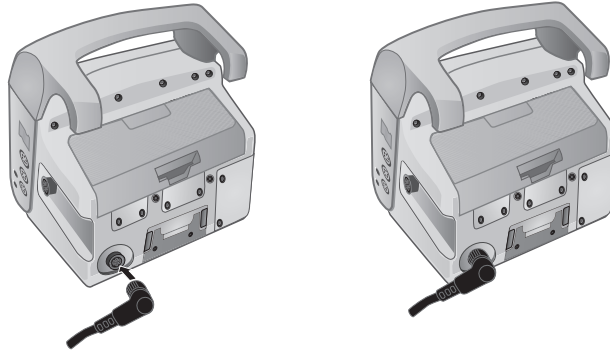


Figure 2-15 Connecting the AC Auxiliary Power Adapter or DC Auxiliary Power Supply

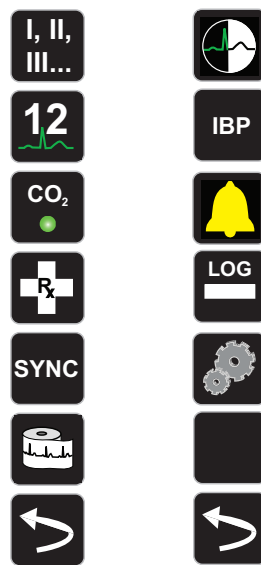
## Navigating the Display Screen

You can access the X Series functions using the quick access keys that are located on the left side of the display screen, and the navigation keys that are located on the right side of the front panel.

### Quick Access Keys
















The seven quick access keys on the left side of the display screen are an easy way to access the functionality of the X Series. When you press the last key (left arrow), five more keys are displayed.

First level keys      Second level keys


























**Table 3: X Series Quick Access Keys**

Quick access key	Description
Lead 	Selects the ECG input source for the first waveform trace.
12 lead 	Displays the 12-lead monitoring screen.
CO <sub>2</sub> 	Turns CO <sub>2</sub> on and off.
Treatment 	Displays the current clinical treatment options.
Sync 	Activates the synchronized cardioversion mode.
Print 	Starts or stops a continuous chart print.
More/Back 	Goes to the next or previous level of quick access keys.
Brightness 	Changes the brightness setting -- toggles through high contrast display (white background), color display (black background), and night vision goggle (NVG) friendly display.
IBP 	Displays IBP setup and zero buttons.
Alarms 	Displays the Limits option to allow the user to view/set all parameter alarm limits.
Log 	Opens the Log Control panel.
Setup 	Displays the Setup menu to allow the user to configure settings such as ECG, display/volume, printer, trends, operational checklist, and supervisor.
Treatment Summary 	Displays treatment summary cases, which you can print.
Manual Mode 	Allows user to change from AED Mode to Manual Mode.
Pause 	Allows user to Pause the rescue cycle.

**Table 3: X Series Quick Access Keys**

Quick access key	Description
Print Trends 	Prints the trends that are displayed in the Trend Summary window.
Trend Settings 	Displays settings for trend display format, trend on interval, and trend on alarm.
Transfer Log 	Transfers the current data in the log to a USB drive.
Disclosure Log Transfer 	Use to transfer the Disclosure logs for up to 15 cases at a time to a remote server for subsequent retrieval.
Clear Log 	Deletes the current data in the log.
Acquire 	Collects 10 seconds of 12-lead data for print or transmission.
Stop Acquisition 	Stops acquisition of 12-lead data.
Patient Information 	Allows you to enter information to accompany 12-lead data: patient name, age, gender, and ID.
Row Up 	Allows you to move to the previous row when entering patient information.
Row Down 	Allows you to move to the next row when entering patient information.
12-Lead Review 	Reviews all your 12-lead captured data.
12-Lead Review Next 	Goes to the next page of the 12-lead snapshot you are reviewing.
12-Lead Staggered Print 	Allows you to print 12-Lead ECG data in four staggered 2.5 second segments.
Transmit 	Transmits 12-lead data.
Exit 12-Lead 	Exits the 12-lead monitoring screen.
Stat Set 	Sets all alarm limits relative to the patient's current vital signs.

**Table 3: X Series Quick Access Keys**

Quick access key	Description
Alarm Cancel 	Pauses (suspends) alarm audio.
Limits 	Displays the current alarm settings.
Disarm 	Safely discharges the defibrillator internally. No energy is delivered to the patient.
IBP Setup 	Brings up the IBP Control Panel for the corresponding channel (P1, P2, or P3).
IBP Zero 	Zeroes the IBP transducer for the corresponding channel (P1, P2, or P3).

## Navigation Keys

Use the navigation keys (up/clockwise arrow, down/counterclockwise arrow, and select button) to navigate through windows and make selections.

### Using Up/Clockwise and Down/Counterclockwise Arrows

Use the up/clockwise down/counterclockwise arrows to do the following:

- Move clockwise and counterclockwise through the main display windows.
- Move up and down in a window.
- Change parameter settings.

### Using the Select Button

Use the Select button to do the following:

- Display the settings window while a parameter is highlighted in the main window.
- Select options from a window.

## Display Brightness

The monitor can display in two different brightness modes:

- high contrast with white background (for optimal display in bright sunlight)
- color with black background (numerics and waveforms are easy to read)

## Common Tasks

The section contains procedures for the following tasks:

- “Setting the Date and Time” on page 2-20.
- “Replacing a Battery Pack on the X Series” on page 2-22.
- “Using Treatment Buttons” on page 2-23

### Setting the Date and Time

The X Series Set Date and Time screen allows you to set the date the X Series will use and its internal real time clock.

To set the X Series unit’s date and time:

1. On the X Series display screen navigate to and select the **Date and Time** field. The Set Date And Time screen displays.

Set Date And Time	
Month	04
Day	14
Year	2015
Hour	11A
Minute	16
Seconds	00
Set Date And Time	

2. Specify the date by navigating to the date fields (**Month, Day and Year**) and adjusting as necessary.
3. Specify the unit’s time by navigating to the time fields (**Hour, Minute, Seconds**) and adjusting as necessary. The selections available in the **Hour** field depend on whether your unit is configured for a 12 or 24 hour (default) clock.

**Note:** For systems with Clock Synchronization enabled, avoid changing the unit’s time manually except at initial configuration.

4. When you are done indicating the date and time, select the **Set Date and Time** field to apply your selections.

## Set Date and Time Screen with Clock Synchronization

For systems with the Clock Synchronization feature enabled, the Set Date and Time screen indicates the date and time of the X Series last synchronization to an external time source and allows you to adjust the clock for Daylight Saving Time. You can choose whether to enable Daylight Saving Time or not by selecting the **Enable/Disable DST** field as appropriate. Adjustments to Daylight Saving Time take effect immediately and must be manually adjusted at every transition between Standard Time and Daylight Saving Time. If enabled the clock will be adjusted forward by 1 hour. These fields only display on systems with the Clock Synchronization feature enabled. For information on Clock Synchronization, see “Configuring Clock Synchronization” on page 22-34.

The screenshot shows the 'Set Date And Time' configuration screen. At the top, there is a toggle for 'Enable DST'. Below it are input fields for 'Month' (04), 'Day' (15), 'Year' (2015), and 'Hour' (10). The 'Year' field is currently selected with a blue highlight. Below these fields, the 'Time of Last Synchronization' is displayed as '10:17:34 2015-04-15'. At the bottom, there is a 'Daylight Saving Time' field set to 'Off' and a back arrow icon.

Field	Value
Enable DST	[Toggle]
Month	04
Day	15
Year	2015
Hour	10
Time of Last Synchronization	10:17:34 2015-04-15
Daylight Saving Time	Off

## Changing the Display Brightness

The following procedure shows how to select the different brightness options.

1. Press the power switch to turn the unit on.
2. Press the Brightness quick access key (  ) repeatedly to toggle through the brightness options until you find your selection.

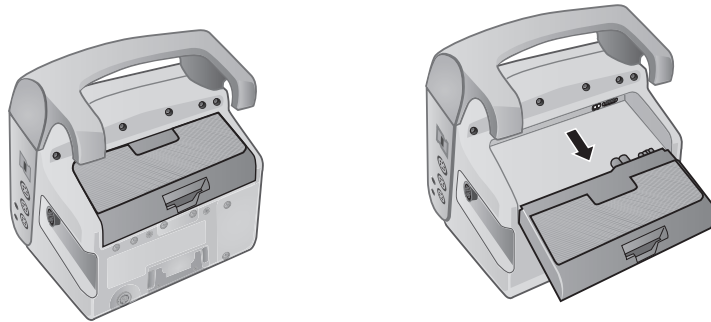
**Note:** Selecting a higher brightness setting (such as 70%) will deplete the battery pack at a faster rate than when choosing a lower brightness setting (such as 30%). To select the brightness setting, go to the Setup>Display/Volume>Display Brightness menu to adjust the display percentage.

## Replacing a Battery Pack on the X Series

This section describes how to replace a battery pack on the X Series.

### Replacing a Battery Pack on the X Series

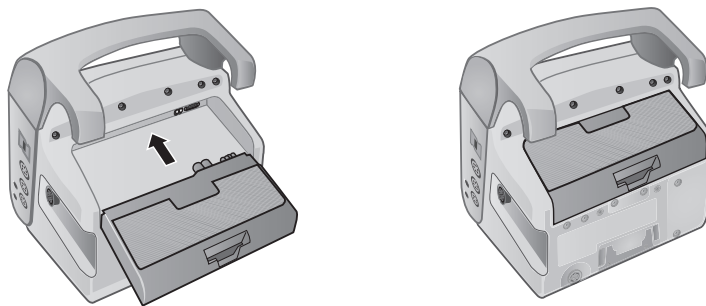
To remove a battery pack, use your fingers to grasp and raise the latch and pull the battery pack out of the compartment.



**Figure 2-16 Removing a Battery Pack**

To install a battery pack:


1. Line up the battery so it will slide into the battery well.
2. Push the battery into place.



**Figure 2-17 Installing a Battery Pack**


---

## Using Treatment Buttons

Pressing the Treatment quick access key () causes the unit to display preconfigured buttons that contain clinical actions. These buttons allow you to add a treatment snapshot (which itemizes drugs or treatments administered to the patient) to a Treatment Summary Report. You can do this by selecting **Print on Treatment Snapshot** from Setup>Supervisor>Printer. The following is a list of preconfigured treatment buttons:

- O2
- ASA
- Nitro
- Morph
- IV
- B Block
- Lido
- MgSO4
- Valium
- Sedate

### Customizing Treatment Buttons

You can also customize up to 9 treatment buttons by pressing the Setup quick access key () and then selecting Supervisor>Log>Treatment Options. Highlight **Define Custom Labels**, and then can customize up to 9 buttons.





# Chapter 3

## Monitoring Overview

---

This chapter provides an overview of the X Series unit's monitoring functions. It describes the types of vital sign monitoring that X Series provides, and the flexibility that the X Series unit gives you in displaying a patient's vital signs information.

### X Series Monitoring Functions

The X Series unit provides an array of standard, and optional, monitoring functions, and allows you to view the vital signs measurements that these functions provide in a variety of formats. The X Series unit also allows you to set alarm limits for each monitoring function. Should a patient's vital signs measurements go outside of these limits, the X Series issues an audible alarm tone and displays visual alarm indications to alert you.

If the X Series unit is powered off for less than 2 minutes, all patient monitoring parameter settings are retained. If the X Series unit is powered off for 2 minutes or longer, the unit operates as if there is a New Patient and all patient-specific parameters (alarm limits, defibrillator energy, etc.) are reset to their default values.

The X Series unit can monitor the following patient vital signs:

- ECG
- Heart Rate
- Respiration Rate
- Temperature
- Invasive Pressures (IBP)
- Non-invasive Blood Pressure (NIBP)
- Capnography (CO<sub>2</sub>)
- Pulse Oximetry (SpO<sub>2</sub>)

## ECG

An ECG waveform trace appears at the top of the display area. You can specify that the unit display the waveform trace of any available ECG source, such as Pads, ECG Leads I, II, or III, and so on, in this area. You can configure the X Series unit to display up to four ECG waveform traces. In addition to being able to specify the ECG source for each waveform trace, you can adjust the display scale of those traces to make them easier to view.

## Heart Rate

A Heart Rate meter gives the patient's heart rate in Beats Per Minute (**bpm**). By default, the X Series unit derives the heart rate from the patient's ECG, but can be configured to use other monitoring functions to derive the patient's heart rate.

## Respiration Rate

A Respiration Rate meter gives the patient's respiration rate in Breaths Per Minute (**br/min**). The X Series unit can be configured to derive the respiration rate from the patient's ECG or from the optional CO<sub>2</sub> monitoring function.


## Temperature

The Temperature (**Temp**) meter can display temperature measurements from up to two temperature probes. The X Series unit provides two separate temperature monitoring channels and, if both are used, displays the monitored temperatures, in degrees F or C, one after the other, followed by the difference between those temperatures.

## Invasive Pressures (IBP)

The X Series unit provides three separate channels for monitoring arterial, venous, or intracranial pressure using internal probes. The pressure measurements for each pressure channel appear in a labeled (**P1**, **P2**, **P3**) numeric display.

## Non-Invasive Blood Pressure (NIBP)

The X Series unit provides patented Smartcuf motion-tolerant technology for NIBP monitoring. NIBP monitoring measures the patient's systolic, diastolic, and mean blood pressure through an inflatable blood pressure cuff that the X Series unit inflates/deflates. NIBP measurements can be taken automatically or on-demand by pressing the NIBP button () on the front panel of the X Series unit. The blood pressure measurements appear in a labeled (**NIBP**) numeric display. You can also specify that the X Series unit display non-invasive pressure waveforms in the waveform trace area.

## Capnography (CO<sub>2</sub>)

CO<sub>2</sub> monitoring measures the CO<sub>2</sub> concentration in a patient's exhaled breath (End Tidal Carbon Dioxide --EtCO<sub>2</sub>). CO<sub>2</sub> monitoring can also measure a patient's breath rate and the CO<sub>2</sub> concentration in the gases supplied to intubated patients (Fractional Inspired Carbon Dioxide -- FiCO<sub>2</sub>). Since FiCO<sub>2</sub> represents the amount of CO<sub>2</sub> present during inhalation, it also serves as an indicator for rebreathing in non-intubated patients. CO<sub>2</sub> monitoring can be used for both intubated and non-intubated patients.


The EtCO<sub>2</sub>, breath rate, and FiCO<sub>2</sub> measurements appear in a labeled (**EtCO2**) numeric display. The EtCO<sub>2</sub> and FiCO<sub>2</sub> measurements can appear as values given in millimeters of mercury (mmHg). You can also specify that the X Series unit display a CO<sub>2</sub> capnogram in the waveform trace display area.

## Pulse Oximetry (SpO<sub>2</sub>)

Pulse Oximetry monitoring measures the oxygen saturation (SpO<sub>2</sub>) of arterial blood at a peripheral site such as a finger or toe. If the optional features SpCO (carboxhemoglobin saturation) and SpMet (methemoglobin saturation) or SpHb (total hemoglobin), SpOC (oxygen content), PVI (pleth variability index) and PI (perfusion index) are installed, the X Series unit also monitors these parameters.

SpO<sub>2</sub> monitoring determines the ratio of oxygenated hemoglobin to total hemoglobin in arterial blood and displays this ratio as percent SpO<sub>2</sub> in a labeled (**SpO2**) numeric display. If the optional features SpCO and SpMet or SpHB, SpOC, PVI and PI are installed, these values alternate and display under the SpO<sub>2</sub> display. You can also specify that the X Series unit display an SpO<sub>2</sub> plethysmograph in the waveform trace display area.

## Monitoring Display Options

The X Series unit gives you great flexibility in how you display a patient's vital signs information. By pressing the Display/Home button (  ) on the front panel, you can successively display the patient's vital signs information in these three windows:

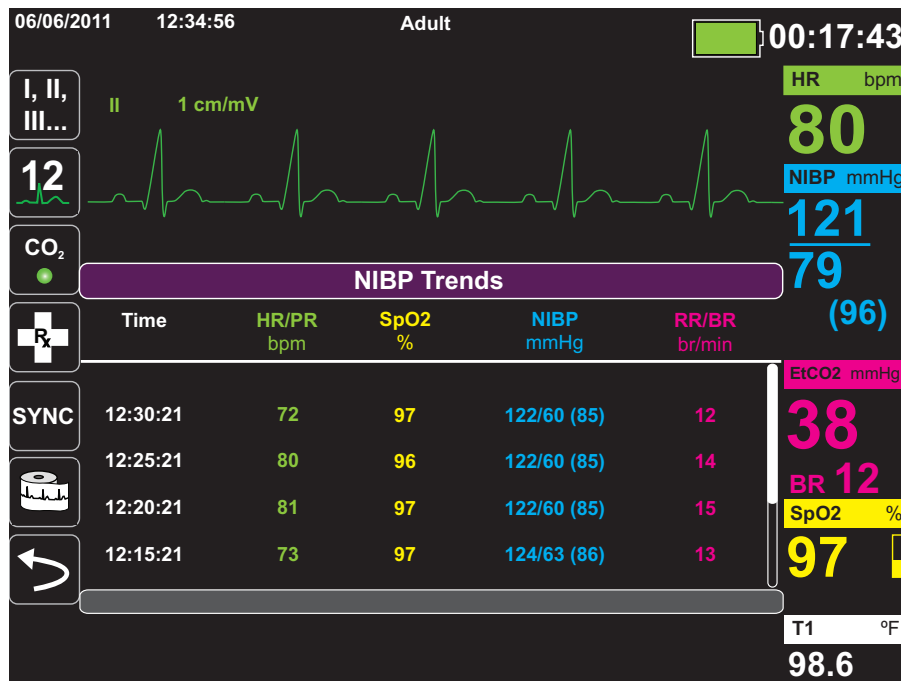
- **Waveform Display window**, which initially displays an ECG waveform trace and numeric displays for each monitoring function.
- **Trends Status window**, which displays a report listing vital signs measurements that the X Series unit logs automatically, and the primary ECG waveform trace.
- **Large Numerics Display window**, on which large numeric displays of all vital signs measurements appear.

The Waveform Display window appears when you power on the X Series unit. Initially, the Waveform Display window displays a single ECG waveform trace. All other monitored values appear in numeric display areas at the bottom of the screen:

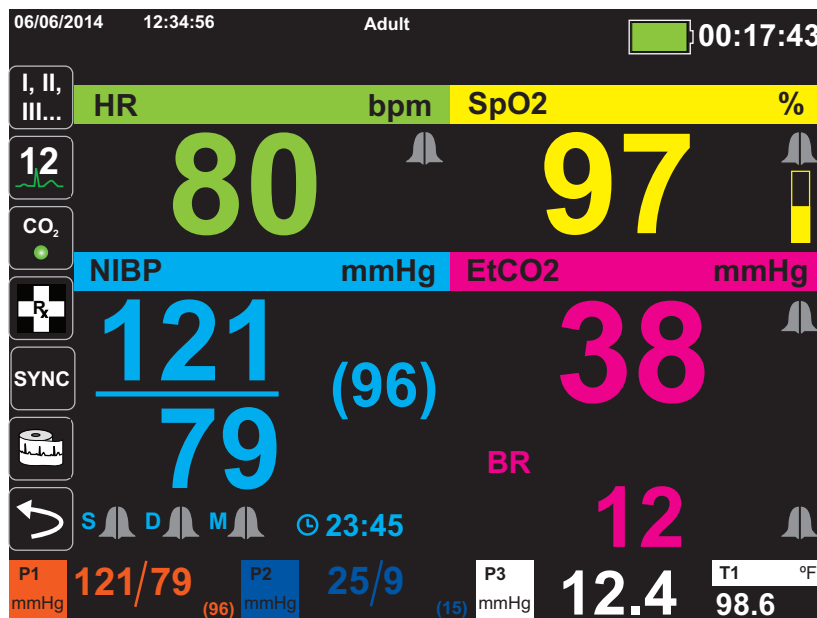


You can display up to four waveform traces that you specify on the Waveform Display window. You will determine how to add waveform traces to this window later in this chapter.

Press the Home/Display button when viewing the Waveform Display window, and the unit displays the Trends Status window. The Trends Status window reports the patient’s vital sign measurements, which the X Series logs automatically at a configurable interval (see the following chapter, *Trends*, for more detailed information about the Trends Status window). The primary ECG waveform trace appears above the Trends report:



Press the Home/Display button when viewing the Trends Status window and the Large Numerics Display window appears. The patient’s vital signs measurements appear in large labeled numeric displays; no waveform trace appears on this screen:



Press the Home/Display button to redisplay the Primary Display window.

**Note:** When the X Series unit is displaying the Defibrillation or Pacing Control panels, the unit will not allow the display the Large Numerics Display window.

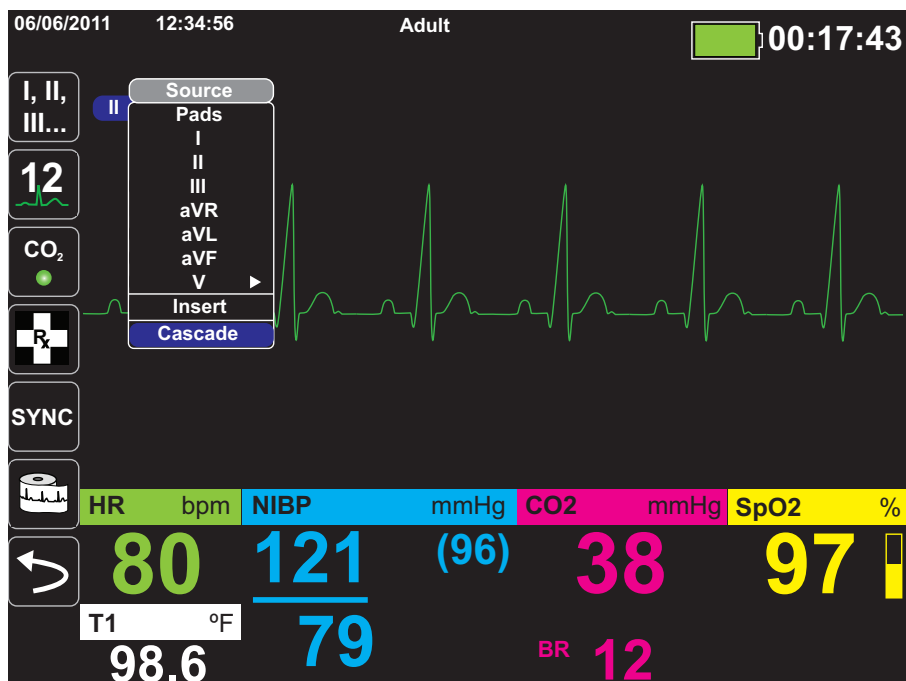
## Configuring the Waveform Display

You can display up to four waveform traces on the Waveform Display window. The first waveform trace always uses an ECG lead as its source (such as **Pads** or Leads **I**, **II**, or **III**, and so on. The default is **Pads**). If **Pads** are not connected, the unit can be configured to automatically default to another ECG lead for the first trace. As you insert the remaining three traces, you can specify that the traces use an ECG lead as the waveform source, or that the trace derive its waveform from other available monitoring functions (such as **Resp**, **CO2**, **SpO2** or IBP channels **P1**, **P2**, or **P3**).

If configured, the unit can display four ECG traces on startup, when no other monitoring devices are attached.

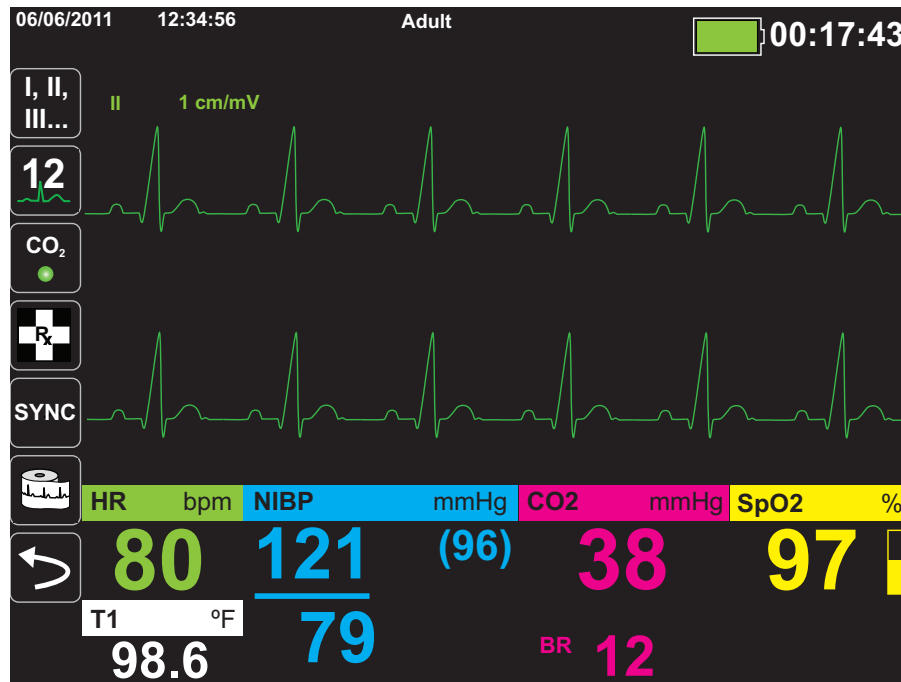
The X Series unit can also cascade a trace onto the adjoining trace area to double the duration of the trace display.

On the Waveform Display window, to insert a new trace (**Insert**) or cascade (**Cascade**) a displayed trace, highlight and select the trace label above the trace. In the following example, the unit is configured to cascade the ECG Lead I trace:



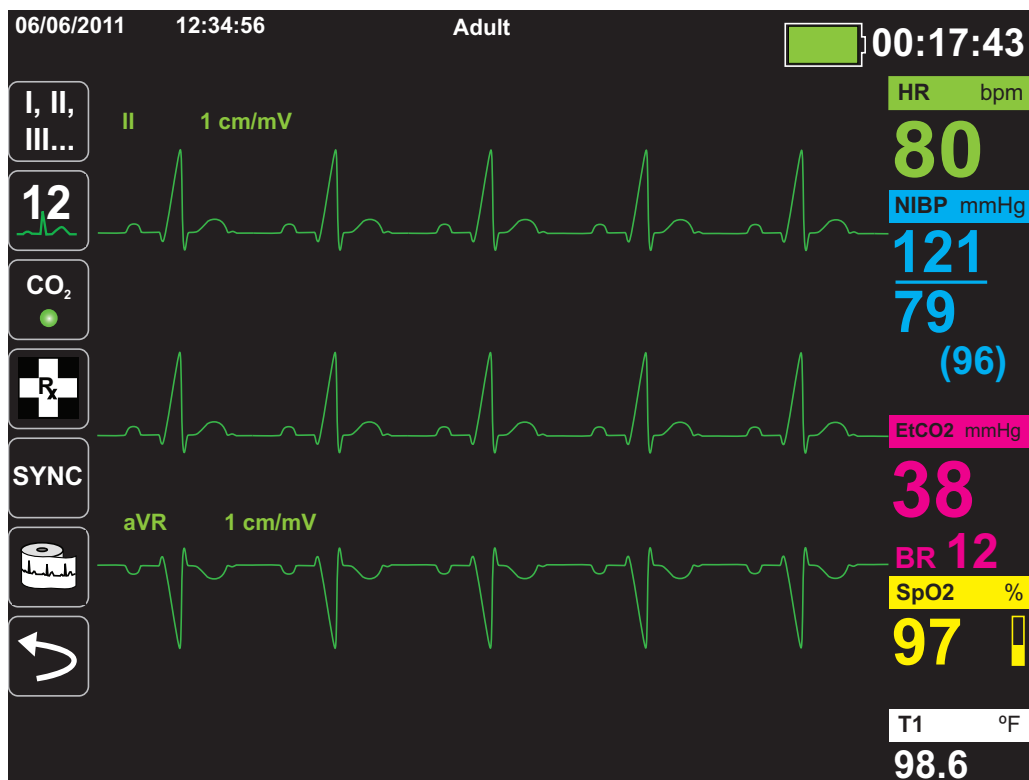
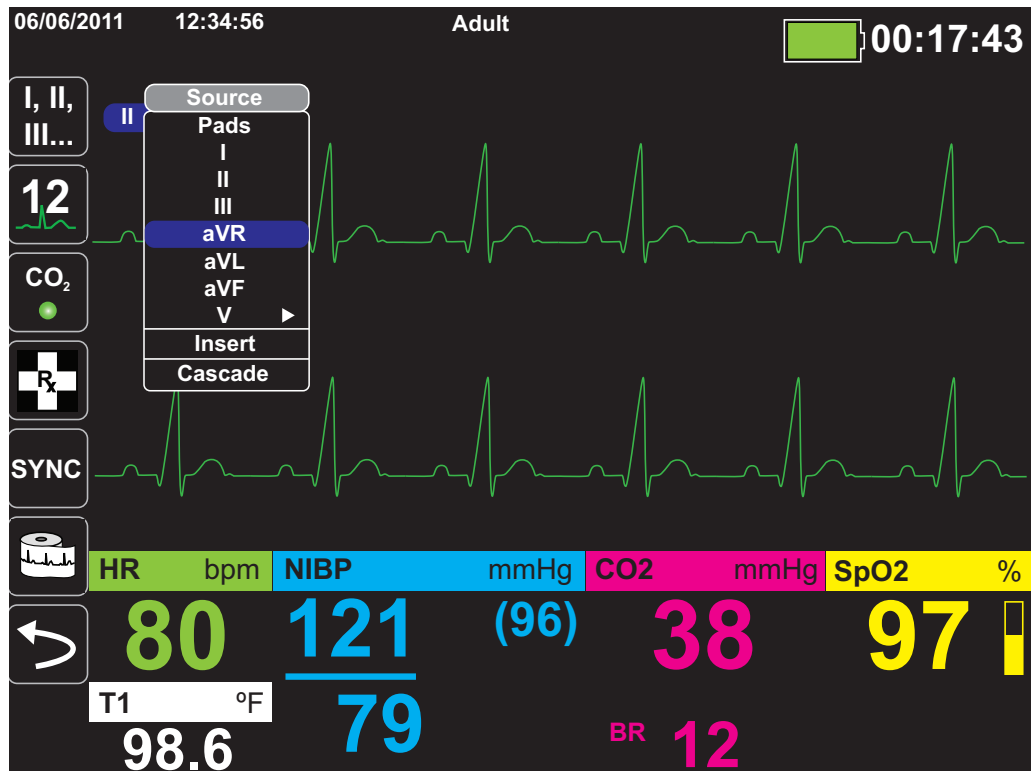
**Note:** The X Series unit automatically inserts a new waveform when you turn on a parameter (CO<sub>2</sub>) or a new sensor signal is present (SPO<sub>2</sub>, IBP). The X Series unit automatically removes a waveform when you turn off a parameter or remove a sensor and the unit displays the resulting equipment alert.

When the unit cascades the ECG Lead II trace, the Waveform Display window appears as follows:



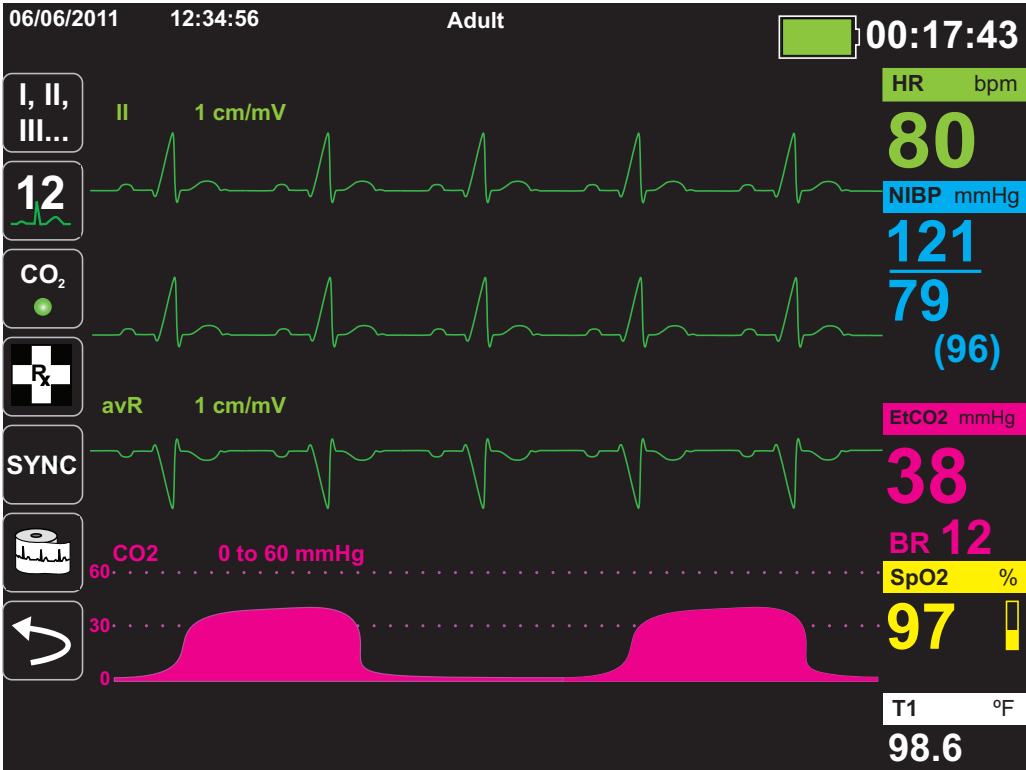
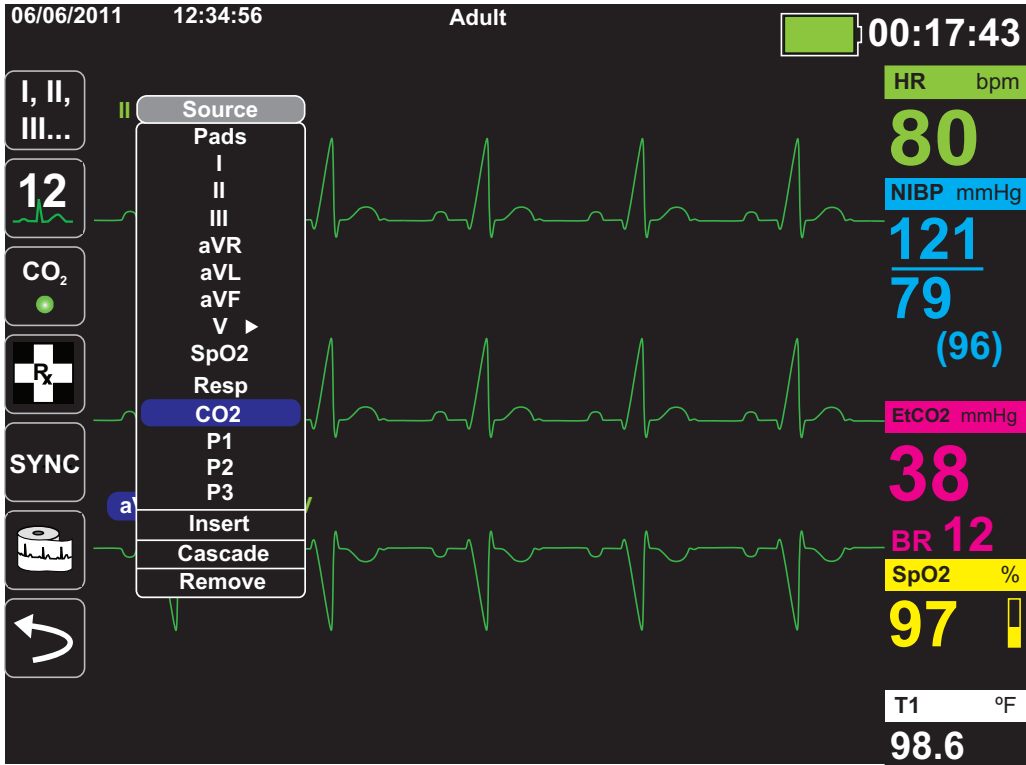
The following screens demonstrate how to insert two more waveform traces into the window. A third trace is inserted for ECG lead **aVR**, and fourth trace for **EtCO<sub>2</sub>** (a capnogram). Notice that when the third trace is inserted, the numeric displays move to the right side of the window to allow more room for the waveform traces.

Inserting a third waveform trace for ECG lead **aVR**:





Inserting a capnogram (CO<sub>2</sub>) into the fourth trace area:






# Chapter 4

## Trends


---

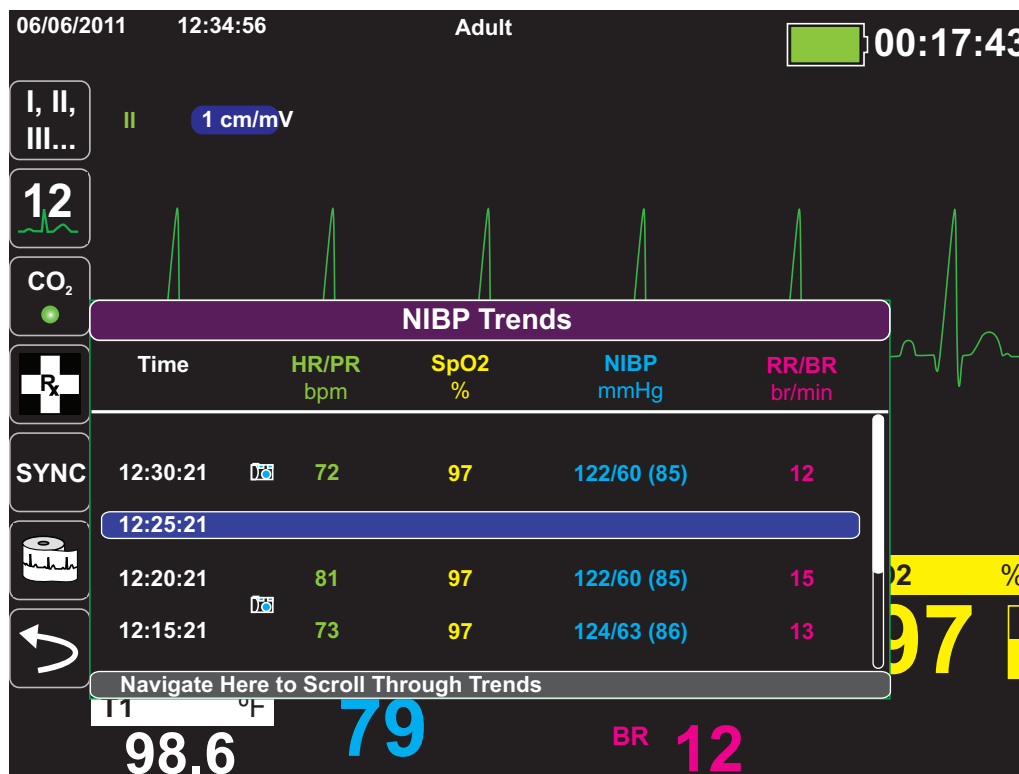
The X Series unit accumulates a patient's trend information by logging all monitored vital sign measurements to memory at a user-configurable interval. It also logs *all* monitored vital sign measurements when the following occurs:

- An NIBP measurement is taken and the **Trend on NIBP** option is on
- You press the Snapshot button (  ) on the front panel
- A patient alarm occurs and the **Trend on Alarm** option is on

The X Series unit can store at least 24 hours of trend information when logged at a 1 minute trend interval. You can view, print, or save to external memory all logged trend information.

## Displaying the Trends Status Window


The X Series unit displays the logged trend information in the Trends status window. Press the Display/Home button (  ) to display the Trends window, the primary ECG trace, and the small numeric displays for each monitoring function:



**Figure 4-1 Trends Status window**

The Trends status window displays the logged trend information and the time at which the trend measurements were logged. While trend measurements are logged to memory at a user-configurable interval, the Trends status window can display the logged information at an interval that you specify, with the exception of NIBP measurements, which are logged and reported at the times they are taken. The Trends status window reports the trends information at 5-minute intervals.

To navigate in the Trends status window:

1. Use the navigation keys to highlight the **Navigate Here to Scroll Through Trends** bar, then press **Select**.
2. Press the **Up/Down** buttons (  ) to scroll through the trend information.

---

## Printing Trend Information

Printed trends are useful for reviewing the patient's vital signs over the last several minutes to the last five hours. You can print vital signs data at one selected time or a trend summary showing vital signs values acquired during the current case (up to the last 24 hours).

### Printing Trend Summary of All Trends

To print a trend summary of all trends for the current patient:

1. Use the navigation keys to highlight the **NIBP Trends** field and press **Select**. The Trend Settings menu displays.
2. Highlight the **Print Trend Summary** field and press **Select**. The Trend Summary Report begins printing.
3. To cancel the report, highlight **Cancel Report** and press **Select**.



### Printing an Individual Trend Snapshot

To print an individual trend snapshot:

1. Highlight the **Navigate here to scroll through trends** field at the bottom of the Trends window and press **Select**.
2. Using the navigation keys, select the trend snapshot you want to print and press **Select**.
3. Highlight **Print this Trend** and press **Select**. The trend snapshot begins printing.



### Printing The 10 Most Recent Trend Snapshots

To print the 10 most recent trends for the current patient:


1. Press the **Log** quick access key () then press the **Print Trends** button (). The Trend Summary menu displays.
2. Navigate to and select the **Select 10 Most Recent** button.
3. Navigate to and select the **Print Trend Summary** button. The 10 most recent trends print for the current patient.



### Printing Specific Trend Snapshots

To print a trend summary for one or more cases:

1. Press the **Log** quick access key () then press **Print Trends** (). The Trend Summary menu displays.
2. Use the navigation keys to select the case or cases you want to print and press **Select**. A check mark displays next to the selected case(s).
3. Highlight the **Print Trend Summary** field and press **Select**. The trend data for all the selected cases begins printing.

## Changing the Trends Status Window Display


By default, the Trends status window displays all logged trend information. It displays the numeric information for all monitoring functions, which the unit logs at a user-configurable interval, and when you take NIBP measurements, when a patient alarm occurs, and when you press .

To configure the display of the Trends status window, press () and press the Trend Settings quick access key () to display the Trends Settings control panel. On the Trends Settings control panel, select **Trend Display Format** to specify the following monitored vital signs that appear in the Trends status window:

<b>Trend Format</b>	<b>Vital Signs Displayed</b>
Resp	HR, SpO2, RR, EtCO2, FiCO2
SpO2	HR, SpO2, SpCO, SpMet
SpHb	HR, SpO2, SpHb, SpOC, PVI
NIBP	HR, SpO2, NIBP, RR
IBP1	HR, SpO2, IBP1, RR
IBP2	HR, SpO2, IBP2 RR
IBP3	HR, SpO2, IBP3, RR
Temp	HR, SpO2, T1, T2, ΔT

---

## Continuous Waveform Recording

Continuous waveform recording allows you to record continuous waveforms to a full disclosure case log for the patient being monitored. This feature needs to be enabled by a supervisor. The supervisor can access this feature by pressing the Setup quick access key () and then selecting Supervisor>Log>Waveform Recording. In this menu, the following settings can be customized:

- **Record Displayed Waveforms** – Record only the top waveform that is displayed or record all waveforms that are displayed.
- **Record Additional Waveforms** – Always record the CO<sub>2</sub> waveform or always record the IBP and the CO<sub>2</sub> waveforms.

There is an additional waveform that can be enabled in the Waveform Recording menu. This option, **Record Pads Imp. Waveform**, measures the patient's impedance between defibrillation electrodes.

**Note:** When Continuous waveform recording is disabled, no waveforms (except snapshots) are recorded.

The full disclosure case can, at a minimum, concurrently store the following information:

- 32 monitor snapshots
- 500 non-ECG events
- 24 hours of continuous ECG (4 waveforms), Capnography, IBP (3 channels), and Pads Impedance

The actual information that is stored depends on usage. Also, the specific combination of stored continuous waveform data depends on how the waveform recording settings are configured in the Supervisor menu.





# Chapter 5

## Alarms

---

The X Series unit supports the detection and indication of *patient alarms* and *technical alerts*.

A patient alarm is any alarm condition that is caused by a monitored patient-related variable, such as a measured vital sign that falls outside of a configured alarm limit. *You can configure patient alarm limits for each of the physiologic monitoring functions.*

A technical alert is monitored equipment-related variable that the X Series unit can detect, such as a disconnected sensor, internal diagnostics failures, and so on. *Technical alerts are always enabled and are not user-configurable.*

Patient alarms are always classified as high-priority alarms. Urgent technical alerts are classified as medium priority alarms. Other equipment status messages are classified as information signals.

Alarm conditions from patient alarms and technical alerts are stored in the Event Log and retained with normal power down or total loss of power.

## Visual Alarm Indicators

In addition to status messages that appear on the display, the X Series unit lights the red or yellow LED on the front panel to indicate the priority level of the highest-priority active alarm. The X Series LEDs indicate the priority level of the highest-priority active alarm as shown in the following table.

Active Alarm/Alert Priority	Visual Alarm/Alert Indicator
High Priority -- Patient Alarm	Flashing Red LED
Medium Priority -- Technical Alert	Flashing Yellow LED
Information Signal; -- Equipment Status Message	Visual message only. No LED indicator

## Audible Alarm Indicators

The X Series unit sounds an audible alarm to indicate the priority level of highest-priority active alarm. The X Series indicates the priority level of the highest-priority active alarm by sounding the audible alarm tones described in the following table.

Active Alarm/Alert Priority	Audible Alarm/Alert Indicator	Alarm/Alert Volume (measured in accordance with ISO 3744)
High Priority -- Patient Alarm	Two sets of five short beep tones, repeated at 15-second intervals	Adjustable range: Maximum Level $\geq$ 69 dB(A) Minimum Level $\geq$ 61 dB(A)
Medium Priority -- Technical Alert	One set of three longer beep tones, repeated at 30-second intervals	Adjustable range: Maximum Level $\geq$ 66 dB(A) Minimum Level $\geq$ 59 dB(A) Volume is 3 to 12 dBA below high priority alarm
Information Signal-- Equipment Status Message	A single short beep tone, not repeated	Volume is at least 6 dBA below the medium priority alert

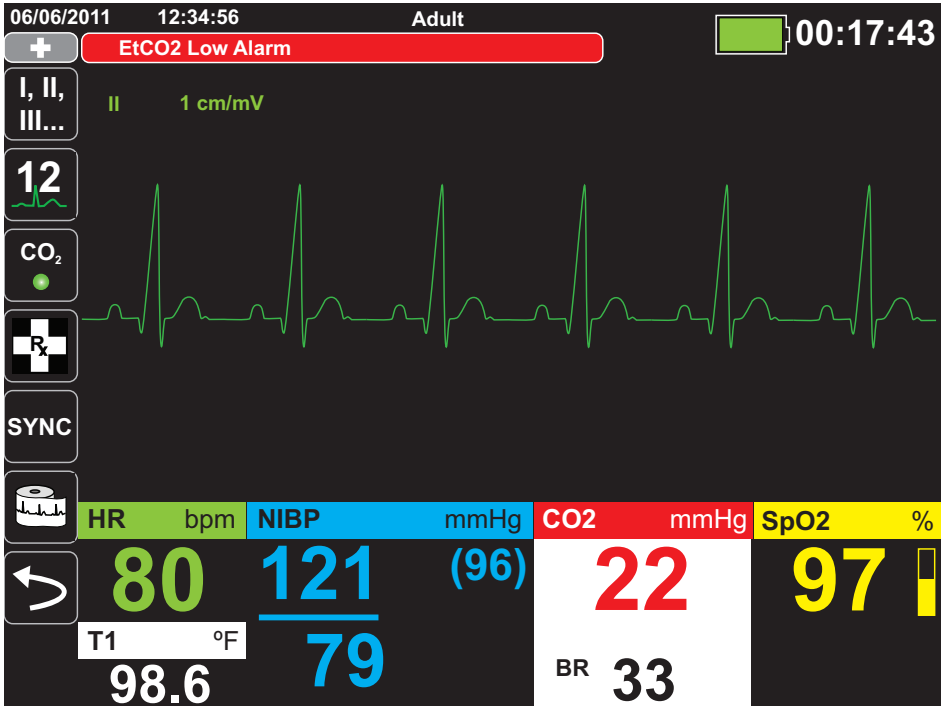
## Alarm Indicator Self-Test

The X Series unit performs a self-test of the audio and visual alarm indicators upon power-up. To ensure that the alarms and alerts are functioning properly, verify that two alarm tones are heard and the green, yellow, and red LEDs are illuminated upon power up.

# Patient Alarm Display

When a patient’s vital signs measurements trigger an alarm, in addition to sounding the patient alarm, the X Series unit displays an alarm message, and changes the display characteristics of the monitoring function’s numeric display (the alarming parameter appears in red against a white background).

In the following example, the EtCO<sub>2</sub> measurement (**22 mmHg**) has dropped below the lower alarm limit (**EtCO<sub>2</sub> Low Alarm**):



## Life Threatening Rhythm Alarms

When LTA monitoring is enabled, the X Series will monitor for the following life threatening ECG rhythms: asystole, ventricular fibrillation, ventricular tachycardia, extreme bradycardia, and extreme tachycardia.

Depending upon configuration of the unit, it generates visible and audible alarms as needed.

**Note:** LTA monitoring is not available in AED mode.

## Equipment Alert Display

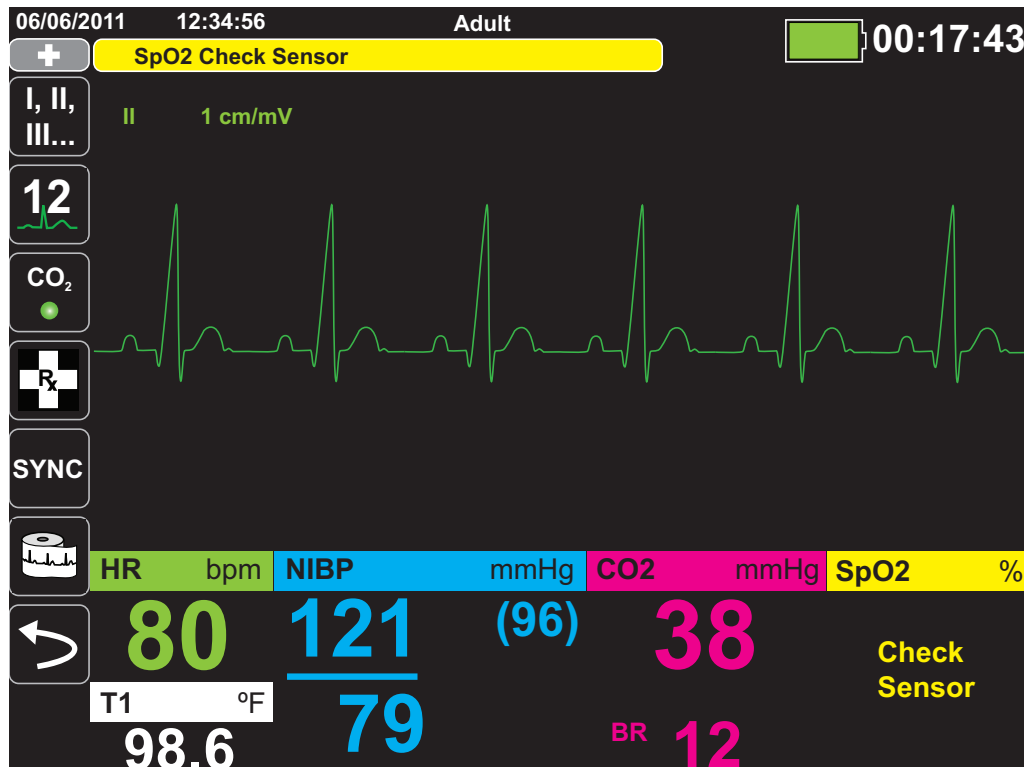
When a problem with the X Series unit or an attached sensor triggers an alert, in addition to sounding an equipment alert, the X Series unit displays an alert message (yellow background, black text).

---

**Warning!** Always respond immediately to a system alarm since the patient may not be monitored during certain alert conditions.

---


In the following example, an equipment alert message indicates that the SpO<sub>2</sub> sensor has become unattached (**SpO<sub>2</sub> Check Sensor**) from the unit:




---


## Responding to Active Alarms

When a patient alarm is triggered and the alarm tone sounds:

1. Check the patient and provide appropriate care.
2. Press the **Alarm Pause/Reset** () button on the X Series unit's front panel to acknowledge the alarm and briefly pause (silence) the alarm (90 seconds).
3. After caring for the patient, check that the appropriate alarms are set (for more information about setting alarms, see appropriate monitoring chapters later in this manual).

**Note:** Pressing the **Alarm Pause/Reset** () button pauses (silences) the alarm tone briefly for all active alarms. If the patient's vital signs measurements trigger another, different alarm, the patient alarm tone will sound, even if the first pause (silence) period hasn't expired.

### Re-enabling an Alarm

To re-enable an alarm before the alarm pause (silence) period has expired, press the **Alarm Pause/Reset** () button.

- 
- Warning!**
- Do not pause (silence) the audible alarm if patient safety may be compromised.
  - Do not adjust alarm signal volume lower than the ambient noise level if this may impede operator recognition of alarm signals.
- 

### Latching Alarms

High priority patient alarms can be configured to be latching or non-latching (default). When alarms are configured to be latching, alarm indicators (sound, message, color) remain whether or not the condition is present. Life Threatening Rhythm Alarms (LTA) are always latching. Latched alarms must be acknowledged even if the condition no longer exists. Latching alarms are useful in situations where the patient may not be continuously attended by the clinical operator as they make you aware of patient alarm conditions whether or not they are still occurring.

When alarms are configured as non-latching alarm indicators clear when the alarm condition ends, whether or not the alarm was Paused (Silenced).







Latching alarms are enabled or disabled (default) in the Setup>Supervisor>Alarms>General>menu.


---

## Pausing (Suspending) Alarms

If you want to temporarily prevent potential or current patient alarms and equipment alert alarms from sounding when caring for a patient, you can pause (suspend) alarm audio for 2, 4, or 15 minutes (depending on your unit configuration) or you can pause (suspend) the alarm audio indefinitely (Audio Off). Alarms automatically resume after the configured pause (suspend) time is up.

To pause (suspend) patient alarms:

1. Press the More quick access key (  ) to access the second set of quick access keys.
2. Press the Alarms quick access key (  ).
3. If you would like to pause (suspend) alarms for the configured amount of time, press  quick access key once. The Alarm Audio Paused icon (  14:55 ) appears at the top of the display next to the message area along with a timer indicating the amount of time the alarms will be paused.
4. If you would like to turn the alarm audio off indefinitely, press the  quick access key a second time. The Alarm Audio Off icon (  On ) appears on the top of the display next to the message area to indicate alarm audio is paused indefinitely for this unit.

**Note:** Press the  quick access key a third time to clear the display and resume alarm audio.

No alarms will sound while alarms are paused (suspended); however, if an alarm occurs during the suspension period, the X Series unit will display visual alarm indicators -- alarm messages in the message area (white text on a red background) and red/white numeric displays).

**Note:** Your X Series unit may be set up to not allow pausing (suspending) alarms.

---

**Warning!** When audible alarms are disabled, make sure that the patient is closely observed.

---

## Alarm Reminders

Your X Series unit may be configured to sound a Reminder Alarm at specified intervals. When the Reminder Alarm is enabled an alarm will sound every 5 (default), 10 or 15 minutes (depending on configuration) if an Audio Off condition persists. When Reminder Alarm is disabled, no reminders are issued if the Audio Off condition continues. You enable or disable the Reminder Alarm in the Setup>Supervisor>Alarms>General>menu.

## Alarm Options

The X Series unit provides alarm options that you can specify through the Supervisor parameter control panel (access to Supervisor is passcode-controlled).

Press the More quick access key (➤), press the Setup quick access key (⚙️), and select **Supervisor**. Using the navigation keys, select the four digits in the Supervisor passcode. Press **SAVE** when you are finished. Once you have entered your supervisor passcode, you will be able to access the configurable options in the Supervisor menu.

Select **Alarms** to display the alarms parameter control panel:

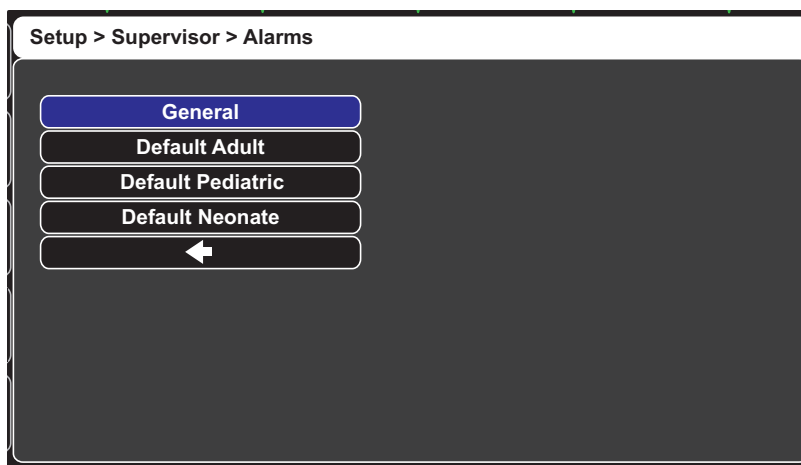


Figure 5-1 Alarms Parameter Control Panel




## Selecting Default Alarm Limits

The three options -- **Default Adult**, **Default Pediatric**, **Default Neonate** -- allow you to set *all* alarm limits to the X Series unit's factory-specified default values, by patient type.

- Warning!**
- A potential hazard exists if different alarm limits are used for the same or similar equipment in any single area.
  - **Confirm the alarm limits are appropriate for the patient each time there is a new patient case.**
  - **Do not set alarm limits to such extreme values that render the alarm system useless.**

## Setting Alarm Limits Relative to the Patient -- Stat Set Option

The X Series unit also allows you to set all alarm limits relative to the patient's current vital signs measurements by performing the following actions:

1. Press .
2. Press the Alarm quick access key (.
3. Press the **Stat Set** quick access key (). The X Series unit sets all parameters to a new value based on the current values as follows:

Parameter (units)	Range	Upper Limit Calculation	Lower Limit Calculation
<b>HR/PR (bpm)</b>	Numeric < 26	Limit is unchanged	Limit = 25
	$26 \leq \text{Numeric} \leq 99$	Limit = Numeric x 1.2	Limit = Numeric x 0.8
	$100 \leq \text{Numeric} \leq 250$	Limit = Numeric + 20	Limit = Numeric - 20
<b>IBP (mmHg)</b>	Numeric > 250	Limit = 250	Limit is unchanged
	Numeric < 26	Limit = Numeric + 5	Limit = Numeric - 5
	$26 \leq \text{Numeric} \leq 99$	Limit = Numeric x 1.2	Limit = Numeric x 0.8
<b>NIBP (mmHg)</b>	Numeric > 99	Limit = Numeric + 20	Limit = Numeric - 20
	Numeric < 26	Limit = Numeric + 5	Limit = Numeric - 5
	$26 \leq \text{Numeric} \leq 99$	Limit = Numeric x 1.2	Limit = Numeric x 0.8
<b>RR/BR (/min)</b>	Numeric > 99	Limit = Numeric + 20	Limit = Numeric - 20
	Numeric < 26	Limit = Numeric + 5	Limit = Numeric - 5
	$26 \leq \text{Numeric} \leq 99$	Limit = Numeric x 1.2	Limit = Numeric x 0.8
	Numeric > 99	Limit = Numeric + 20	Limit = Numeric - 20



<b>SpO<sub>2</sub></b> (%)	Entire range	Limit = 100 (Adult and Pediatric) Limit = Numeric + 5 (Neonate)	Limit = Numeric - 5
<b>SpCO</b> (%)	Entire range	Limit = Numeric + 2 Upper limit 40	Limit = Numeric - 2 Lower limit 0
<b>SpMet</b> (%)	Entire range	Limit = Numeric + 2 Upper limit 15	Limit = Numeric - 2 Lower limit 0
<b>SpHb</b> (g/dL)	Entire range	Limit = Numeric + 2	Limit = 0
<b>SpHb</b> (mmo/L)	Entire range	Limit = Numeric + 1	Limit = 0
<b>SpOC</b> (ml/dL)	Entire range	Limit = Numeric + 2	Limit = 0
<b>PVI</b> (%)	Entire range	Limit = Numeric + 5	Limit = Numeric - 5
<b>PI</b> (%)	Entire range	Limit = Numeric + 2	Limit = 0
<b>EtCO<sub>2</sub></b> (mmHg)	Entire range	Limit = Numeric + 10	Limit = Numeric - 5 mmHg <i>unless</i> the numeric falls below the lower alarm limit range, in which case Stat Set sets the lower limit to 15 mmHg.
<b>FiCO<sub>2</sub></b> (mmHg)	Entire range	Limit = Numeric + 5	N/A
<b>Temp</b> (°C)	Entire range	Limit = Numeric + 0.5	Limit = Numeric - 0.5
<b>Temp</b> (°F)	Entire range	Limit = Numeric + 0.9	Limit = Numeric - 0.9



# Chapter 6

## Monitoring ECG

---

This chapter describes how to use the X Series unit to monitor ECG.

X Series units can perform ECG monitoring through 3-, 5-, or 12-lead ECG patient cables, Multi-Function Pads, or standard defibrillation paddles. The use of an ECG patient cable and electrodes is required, however, to monitor ECG during pacing.

OneStep cables and electrodes cannot be used for ECG monitoring.

You can use a 3-Lead, 5-Lead, or 12-Lead wire configuration for ECG monitoring (see 12-Lead ECG Interpretive Analysis for more information on 12-lead monitoring).

- Warning!**
- **Excessive body hair or wet, sweaty skin may interfere with electrode adhesion. Remove the hair and/or moisture from the area where the electrode is to be attached.**
  - **Use only electrodes that are well within the expiration date indicated on the package.**
  - **Remove ECG electrodes from their sealed package immediately prior to use. Using previously opened or out-of- date electrodes may degrade the ECG signal quality.**
  - **Monitoring electrodes may become polarized during defibrillator discharge, causing the ECG waveform to briefly go off screen. ZOLL Medical Corporation recommends the use of high quality silver/silver chloride (Ag/AgCl) electrodes to minimize this effect; the circuitry in the instrument returns the trace to the monitor display within a few seconds.**
  - **To assure protection against the effects of defibrillator discharge, use only ZOLL-approved accessories.**
  - **To avoid a shock hazard and interference from nearby electrical equipment, keep electrodes and patient cables away from grounded metal and other electrical equipment.**
  - **To avoid electrosurgery burns at monitoring sites, ensure proper connection of the electrosurgery return circuit so that the return paths cannot be made through monitoring electrodes or probes.**
  - **Check the operation and integrity of the X Series unit and ECG cable regularly by performing the Daily Operational Verification Test.**
  - **Implanted pacemakers may cause the heart rate meter to count the pacemaker rate during incidents of cardiac arrest or other arrhythmias. Carefully observe pacemaker patients. Check the patient's pulse; do not rely solely on heart rate meters. Dedicated pacemaker detection circuitry may not detect all implanted pacemaker spikes. Patient history and physical exam are important in determining the presence of an implanted pacemaker.**
-

## ECG Monitoring Setup

The proper application and placement of electrodes is essential for high quality ECG monitoring. Good contact between the electrode and skin minimizes motion artifact and signal interference.

The following procedure describes how to monitor a patient's ECG using 3- and 5-Lead ECG cables. For information on the application and use on MultiFunction Pads and External Paddles, which you can also use to monitor ECG, see Chapter 15, *Manual Defibrillation*.

To monitor a patient's ECG using 3- and 5-Lead ECG cables, perform the following steps:

1. Prepare the patient's skin for electrode application:
2. Apply the electrode pads to the patient.
3. Connect each lead of the ECG cable to the appropriate electrode.
4. Insert the patient cable plug into the ECG input connector on the X Series unit.
5. Select the ECG waveforms to be displayed on the waveform trace display screen.
6. Observe the patient's electrocardiogram on the display, and adjust size of the ECG waveform trace, as necessary.

### Preparing the Patient for Electrode Application

The proper application of electrodes is essential for high quality ECG monitoring. Good contact between the electrode and skin minimizes motion artifact and signal interference.

Before applying electrodes, prepare the patient's skin, as necessary:

- Shave or clip excess hair at electrode site.
- Clean oily skin with an alcohol pad.
- Rub site briskly to dry.

## Applying Electrodes to the Patient

The following sections show where to place electrodes when using 3- and 5-Lead cables to perform ECG monitoring. For 3-Lead ECG cables, apply electrodes as in Figure 4-1, *3-Lead Electrode Placement*. For 5-Lead ECG cables, apply electrodes as in Figure 4-2, *5-Lead Electrode Placement*.

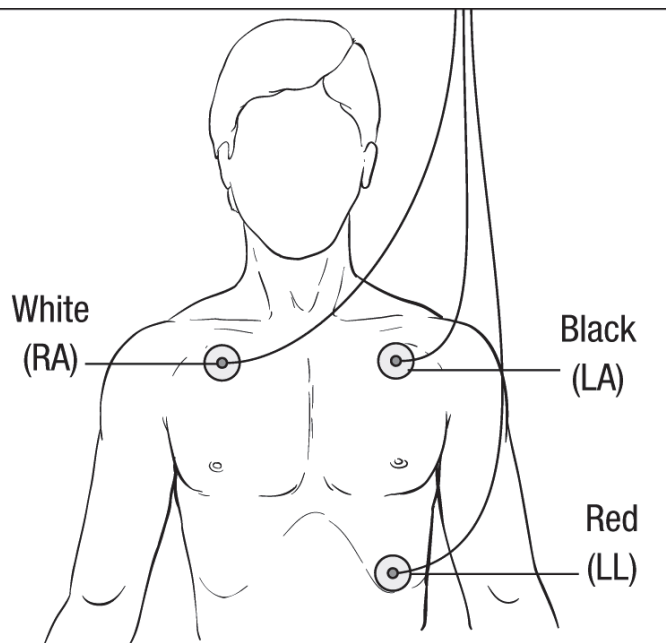
Avoid placing electrodes over tendons and major muscle masses.

Make sure that the ECG electrodes are placed to allow defibrillation, if necessary.

### 3-Lead Electrode Placement

Depending upon local usage, the ECG leads are marked either RA, LA, and LL (or R, L, and F). The following table shows the markings and color codes for the different lead sets.

AHA Color Coding	IEC Color Coding	Placement of Electrodes
RA/White Electrode	R/Red Electrode	Place near patient's right mid-clavicular line, directly below clavicle.
LA/Black Electrode	L/Yellow Electrode	Place near patient's left mid-clavicular line, directly below clavicle.
LL/Red Electrode	F/Green Electrode	Place between 6th and 7th intercostal space on patient's left mid-clavicular line.



**Figure 6-1 3-Lead Electrode Placement**

### 5-Lead Electrode Placement

Depending upon local usage, the ECG leads are marked either RA, LA, LL, RL, and V or R, L, F, N and C. The following table shows the markings and color codes for the different lead sets.

AHA Color Coding	IEC Color Coding	Placement of Electrodes
RA/White Electrode	R/Red Electrode	Place near patient's right mid-clavicular line, directly below clavicle.
LA/Black Electrode	L/Yellow Electrode	Place near patient's left mid-clavicular line, directly below clavicle.
LL/Red Electrode	F/Green Electrode	Place between 6th and 7th intercostal space on patient's left mid-clavicular line.
RL/Green* Electrode	N/Black* Electrode	Place between 6th and 7th intercostal space on patient's right mid-clavicular line.
V/Brown* Electrode	C/White* Electrode	Single movable chest electrode. Place this electrode in one of the positions, V1 - V6, as shown in the following figure.  V1 -- 4th intercostal space at right sternal margin. V2 -- 4th intercostal space at left sternal margin. V3 -- Midway between V2 and V4 leads. V4 -- 5th intercostal space at mid-clavicular line. V5 -- Same transverse level as V4 at left anterior-axillary line. V6 -- Same transverse level as V4 at left mid-axillary line.

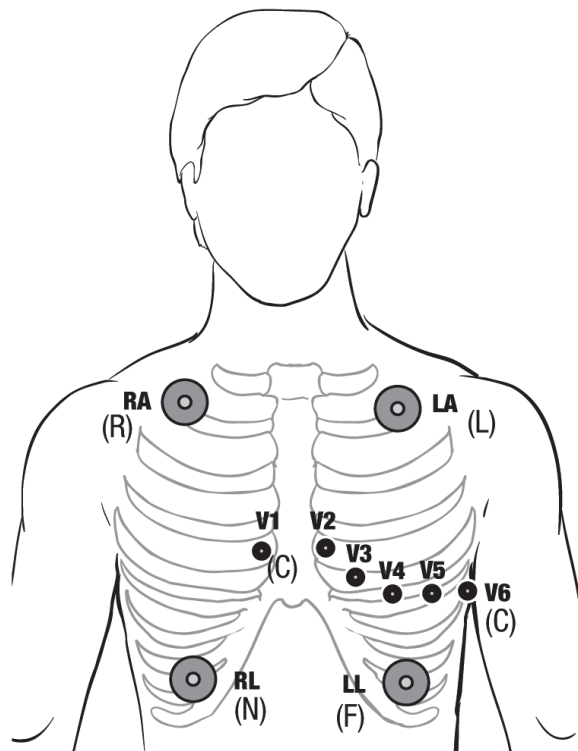


Figure 6-2 5-Lead Electrode Placement

## Connecting the ECG Cable To the X Series Unit

The X Series unit accepts Welch Allyn Propaq® ECG cables as well as ZOLL X Series ECG cables. Connect the ECG cable to the ECG connector on the left side of the X Series unit as follows:

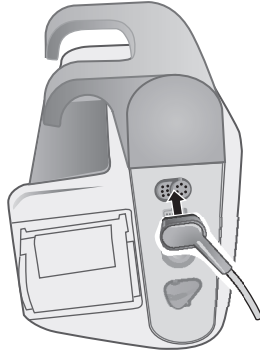


Figure 6-3 Connecting ECG Cable to X Series Unit


## Selecting ECG Waveforms for Display

You can fit up to four waveforms on the X Series display. The first waveform at the top of the display is always an ECG waveform. (If **Pads** are not connected, the unit can be configured to automatically default to another ECG lead.) In the following example, Lead II (RA-LL), is the source of the ECG waveform trace:

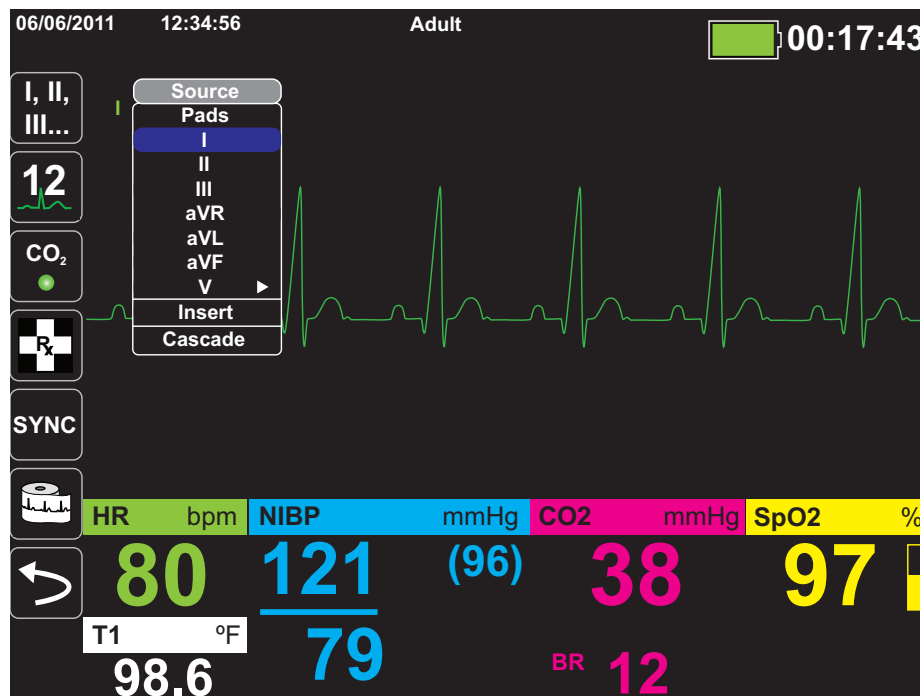




The X Series unit is configured to display **Pads** by default for the top trace. If configured, the unit can also display four ECG traces on startup, when no other monitoring devices are attached.

There are two ways to specify which ECG lead is the source of the primary waveform trace. One way is to press the ECG lead selection quick access key  to display the available ECG waveform sources. The available waveform sources are determined by the type of ECG cable connected to the unit.

The other way to specify the source of the primary waveform trace is to navigate to and select the source label for the primary ECG waveform (Lead I in the screen below). The X Series unit then displays the available ECG waveform sources. The following example illustrates the waveform source list that the X Series unit displays when a 5-lead ECG cable is connected to it. The list of available ECG waveform sources includes Leads I, II, III, aVR, aVL, aVF, and V. You can select Lead II (the default), or use the navigation keys to highlight and select another displayed ECG lead as the source for the waveform trace.



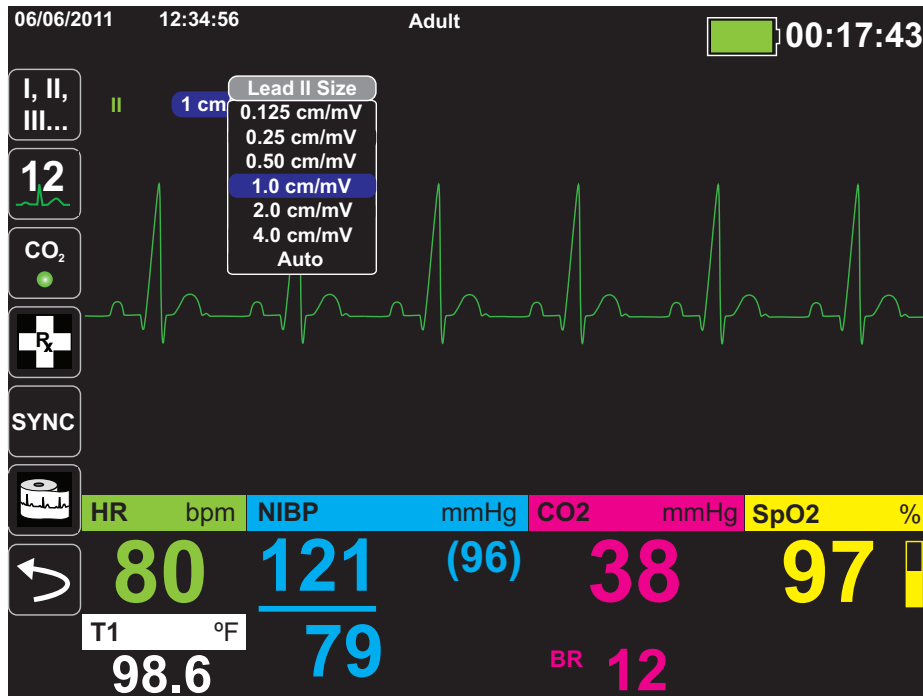
Select a current waveform source, and the unit displays the waveform immediately. If you select a waveform source that is not currently available, the unit displays the message, *LEAD FAULT*.

For more information on how to configure the display of waveforms on the X Series unit, see Chapter 3, *Monitoring Overview*.

## Selecting the Waveform Trace Size

The X Series unit allows you to select the waveform trace size to adjust the size of displayed the ECG waveform.

To select the waveform size, use the navigation keys to highlight and select the trace size that appears to the right of the electrode label:



The default trace size is **1cm/mV**. You can select a larger (**2.0, 4.0 cm/mV**) or smaller (**0.125, 0.25, 0.50 cm/mV**) trace size. You can also specify that the X Series unit select a best-fit trace size (**AUTO**).

---

## ECG Monitoring and Pacemakers

When the unit performs ECG monitoring on a patient with an implantable pacemaker, the unit's Pacer indicator feature can indicate the occurrence of pacemaker signals.

If the Pacer Indicator setting is **ON**, the X Series performs the following actions:






- detects the implantable pacemaker pulses
- blanks the pacemaker pulses from the waveform—preventing them from disturbing the ECG waveform and allowing for an accurate QRS detection
- displays and prints vertical dashed lines to indicate the detected pacemaker signals

If the Pacer Indicator setting is **OFF**, the X Series does not perform the following actions:

- detect the implantable pacemaker pulses
- blank the pacemaker pulses from the waveform
- display or print the vertical dashed line pacer markers

You can turn the Pacer Indicator **ON/OFF** from the Setup>ECG menu.

To turn the Pacer Indicator **ON/OFF**:

1. Press the **More** quick access key ()
2. Press the **Setup** quick access key ()
3. Use the navigation keys to select **ECG** then press .
4. Use the navigation keys to highlight and select **Patient Pace Marker** then press .
5. Use the navigation keys to select **On** or **Off** as appropriate. When you select **Off**, the Pacer Off Indicator() icon appears in the top ECG trace on the Display Screen to indicate the pacer indicator is off. If the patient has a cardiac pacemaker, the Paced Indicator should be set to **On** indicating that pace pulse detection is On.

There are situations where ECG artifact could simulate pacemaker signals which could cause false pacemaker detection and blanking. These situations may cause inaccurate QRS detection and it may be desirable to turn the Pacer Indicator **off**. Inversely, when the Pacer Indicator setting is **OFF**, implantable pacemaker signals may cause inaccurate QRS detection and it may be desirable to turn the Pacer Indicator on.

---

## ECG System Messages

When monitoring ECG, the X Series unit may display the following messages:

System Message	Cause
LEAD FAULT	The current ECG source lead is defective (check lead and replace, if necessary).  -- OR --  An unavailable waveform source has been specified for the trace display (check specified waveform source and correct, if necessary).
PADDLE FAULT or CABLE FAULT	Check the pad, paddle or cable and replace if necessary.

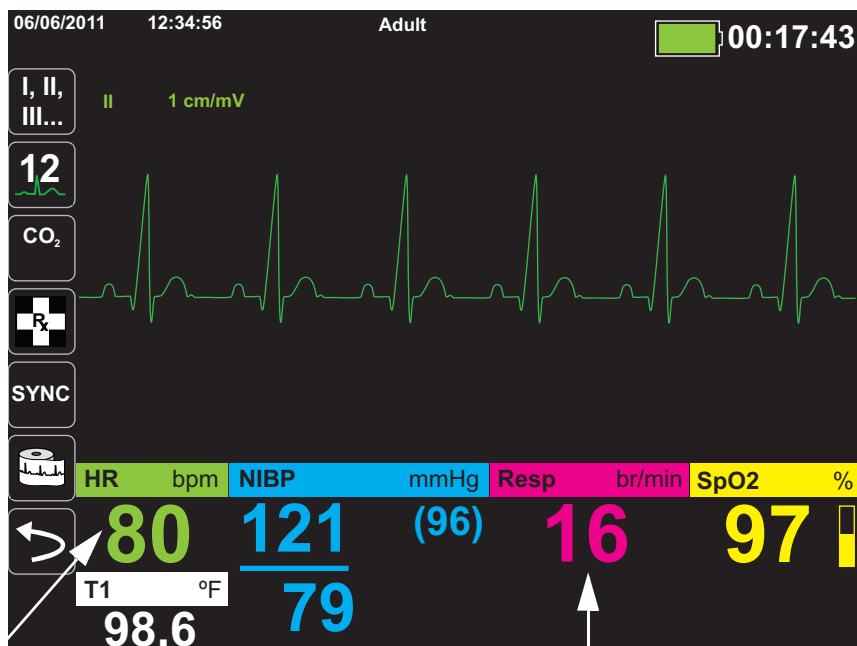
**Note:** If an ECG Monitoring cable is intentionally disconnected, you can disable the Lead Fault alarm by Pausing (Suspending) the alarm audio. See “Pausing (Suspending) Alarms” on page 5-6 for more information.

# Chapter 7

## Monitoring Respiration (Resp) and Heart Rate (HR)

This chapter describes how to use the X Series unit to monitor Respiration (**Resp**) and Heart Rate (**HR**).

The X Series unit displays Respiration (**Resp**) and Heart Rate (**HR**) meters. The Respiration and Heart Rate meters display values that the X Series unit derives from measurements taken by other X Series monitoring functions.



Heart Rate Meter

Respiration Meter

**Note:** The respiration rate is disabled during defibrillation. During defibrillation, the respiration rate will display ??? on the snapshot.

## Respiration/Breath Rate Meter

If enabled, the X Series unit displays the patient's respiration in the Respiration/Breath Rate Meter.



The respiration meter displays the respiration rate that it derives, by default, from the unit's CO<sub>2</sub> monitoring function. If CO<sub>2</sub> monitoring is not available, the unit derives the respiration rate through *impedance pneumography*, using a specified ECG electrode configuration. If ECG monitoring isn't functioning, the **Resp/BR** meter will not display a respiration rate.

### Using Impedance Pneumography to Measure Respiration

Impedance pneumography detects respiration by applying a high-frequency, low-current AC signal to the patient and measuring the changes in impedance through ECG electrode Lead I (RA-LA) or Lead II (RA-LL). As the patient inhales and chest volume expands, impedance increases; as the patient exhales, impedance decreases.

- 
- Warning!**
- **Impedance pneumography detects respiratory effort through changes in chest volume. However, No Breath episodes with continued respiratory effort may go undetected. Always monitor and set alarms for SpO<sub>2</sub> when using impedance pneumography to monitor respiratory function.**
  - **With any monitor that detects respiratory effort through impedance pneumography, artifact due to patient motion, apnea mattress shaking, or electrocautery use may cause apnea episodes to go undetected. Always monitor and set alarms for SpO<sub>2</sub> when using impedance pneumography to monitor respiratory function.**
  - **Due to susceptibility for motion and vibrations, it may not be appropriate to use impedance pneumography with patients during active transport.**
  - **When using impedance pneumography, do not use the X Series unit with another respiration monitor that also uses impedance pneumography on the same patient. The respiration measurement signals may interfere with one another and could affect the affect the respiration accuracy.**
  - **Impedance pneumography is *not* recommended for use on paced patients, because pacemaker pulses may be falsely counted as breaths.**
  - **Impedance pneumography is not recommended for use with high frequency ventilation.**
  - **Since impedance pneumography uses the same leads as the ECG channel, the X Series unit determines which signals are cardiovascular artifact and which signals**

**are the result of respiratory effort. If the breath rate is within five percent of the heart rate, the monitor may ignore breaths and trigger a respiration alarm.**


---

## Configuring Respiration (RR/BR) Alarms and Settings





The X Series unit allows you to enable and disable the Respiration (**RR/BR**) Rate alarm, to set alarm limits, and to specify the ECG monitoring source for the Respiration rate.

### Enabling/Disabling RR/BR Alarms and Setting Alarm Limits

When enabled, the X Series unit sounds alarms whenever the patient's respiration rate is above or below the specified respiration rate alarm limits.

To enable (or disable) Resp alarms and set Upper and Lower alarm limits, you can either do so through the Alarms quick access key () or the **Resp Parameter Control Panel**.

To configure **RR/BR** alarms through the **Alarms** quick access key:

1. Press .
2. Press .
3. Press the **Limits** quick access key () . Use the navigation keys to highlight and select the **RR/BR Alarm** menu selection.
4. On the **RR/BR Alarm Settings** menu, use the navigation keys to select the fields that you want to change:
  - **Upper Limit Enable**
  - **Lower Limit Enable**
  - **Upper Limit**
  - **Lower Limit**
5. When you are finished changing values on the alarm menu, navigate to the Backarrow key () to confirm your choices and exit the menu.

### Respiration Rate Alarm Limits

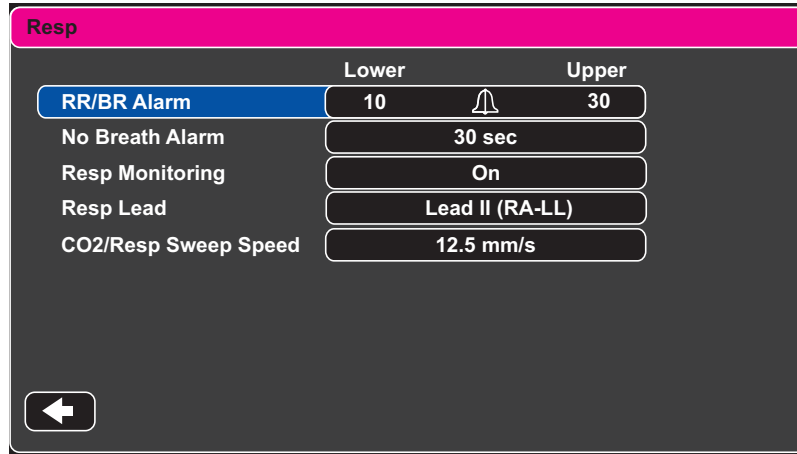
Initially, the **Resp Alarm Settings** menu specifies that Resp alarms are enabled (**ON**) or disabled (**OFF**), and displays the default Upper and Lower respiration rate alarm limits. The upper and lower limits can be **ON** or **OFF** (default is **OFF**). The following table lists the default respiration rate alarm limits for adult, pediatric, and neonate patients, and gives the range in which you can set these limits:

Patient Type	Respiration Rate Default	Respiration Rate Range
Adult	Lower: 3 br/min Upper: 50 br/min	Lower: 0 to 145 br/min Upper: 5 to 150 br/min
Pediatric	Lower: 3 br/min Upper: 50 br/min	Lower: 0 to 145 br/min Upper: 5 to 150 br/min
Neonate	Lower: 12 br/min Upper: 80 br/min	Lower: 0 to 145 br/min Upper: 5 to 150 br/min



## Using the Resp Parameter Control Panel

To configure alarms through the **Resp** Parameter Control Panel, use the navigation keys to highlight and select the Respiration Rate meter and display the **Resp** Parameter Control Panel:



The **Resp** Parameter Control Panel allows you to set the following parameters:

- **RR/BR Alarm** -- enable/disable the Resp alarm and set high/low alarm limits.
- **No Breath Alarm** -- sets the duration of the No Breath alarm, or disables alarm by selecting “Off”.
- **Resp Monitoring** -- enable/disable respiration monitoring.
- **Resp Lead** -- selects the Resp lead, Lead I (RA-LA) or Lead II (RA-LL), from which the X Series unit calculates the respiration rate. Resp Lead selection is independent of ECG Lead selection.
- **CO2/Resp Sweep Speed** -- sets the respiratory sweep speed on the display.

### Enabling/Disabling Resp Monitoring

Select the Resp Monitoring prompt to enable or disable **Resp** monitoring. When Resp Monitoring is set to On (the default), the X Series unit displays the Respiration Rate Meter. When set to off, X Series removes the Respiration Rate meter from the display.

---

**Warning!** When using impedance pneumography, the X Series unit automatically rejects cardiovascular artifact (CVA). This function requires the accurate ECG R-wave detection. Therefore, always select the ECG lead with the most prominent QRS complex when using impedance pneumography to monitor respiration.

---

## Heart Rate Meter

The Heart Rate meter displays the heart rate that it derives from the ECG monitoring function (by default) or from a monitoring function that you specify. If the ECG (or user-specified monitor function) measurements are not available, the Heart Rate meter derives the heart rate from the following monitoring functions, if they are available, in this order: User-selected default source, ECG, IBP channel 1, SpO<sub>2</sub>, IBP channel 2, IBP channel 3, and NIBP. The Heart Rate meter is labeled **HR** (as in the following example) if the source is ECG, and **PR** if any other source is used.

**Note:** The Heart Rate meter displays heart rates below 20 as three dashes (---) and heart rates above 300 as three plus signs (+++).




## Configuring Heart Rate (HR) Meter Alarms




The X Series unit allows you to enable and disable the Heart Rate (HR) alarm, to set alarm limits, and to select a Heart Rate tone.

### Enabling/Disabling HR Alarms and Setting Alarm Limits

When enabled, the X Series unit sounds alarms whenever the patient's heart rate is above or below the specified heart rate alarm limits.

To enable (or disable) HR alarms and set Upper and Lower alarm limits, you can either do so through the Alarms quick access key () or the **HR/PR Parameter Control Panel**.

To configure HR alarms through the **Alarms** quick access key:

1. Press .
2. Press .
3. Press .
4. Use the navigation buttons to highlight and select **HR/PR Alarm**.
5. On the HR/PR Alarm Settings menu, use the navigation keys to select the fields that you want to change:
  - **Upper Limit Enable**
  - **Lower Limit Enable**
  - **Upper Limit**
  - **Lower Limit**



When you are finished changing values on the alarm menu, navigate to the Backarrow key to confirm your choices and exit the menu.

**Heart Rate (HR/PR) Alarm Limits**

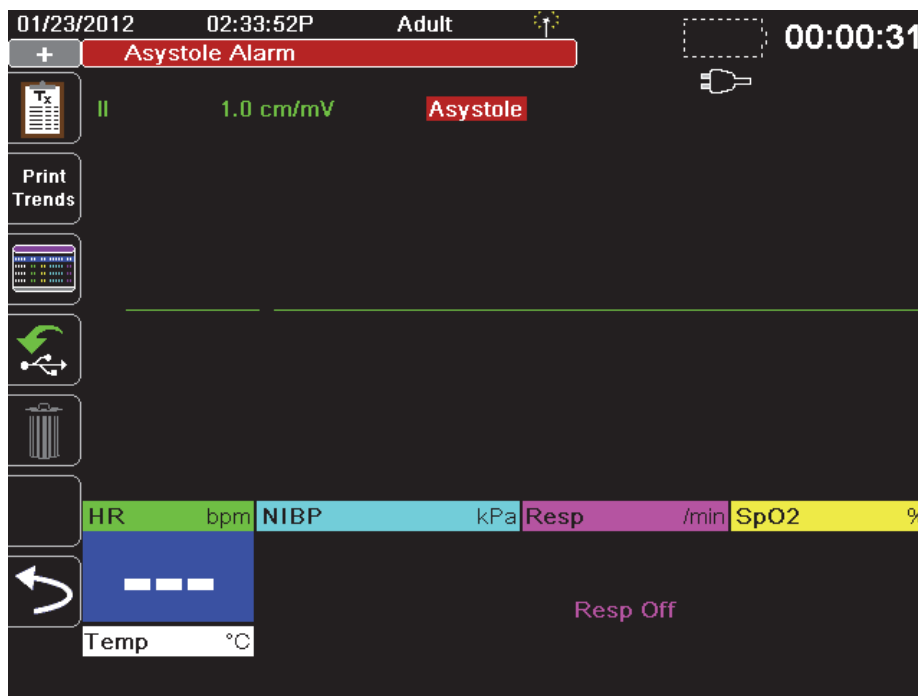
Initially, the HR/PR Alarm Settings menu specifies that alarms are enabled (**ON**) or disabled (**OFF**), and displays the default Upper and Lower heart rate alarm limits. The upper and lower limits can be **ON** or **OFF** (default is **OFF**). The following table lists the default HR alarm limits for adult, pediatric, and neonate patients, and gives the range in which you can set these limits:

<b>Patient Type</b>	<b>HR Default</b>	<b>HR Range</b>
Adult	Lower: 50 BPM Upper: 120 BPM	Lower: 30 to 298 BPM Upper: 32 to 300 BPM
Pediatric	Lower: 50 BPM Upper: 150 BPM	Lower: 30 to 298 BPM Upper: 32 to 300 BPM
Neonate	Lower: 100 BPM Upper: 200 BPM	Lower: 30 to 298 BPM Upper: 32 to 300 BPM

## Life Threatening Rhythm Alarms




When LTA monitoring is enabled, the X Series unit will monitor for the following life threatening ECG rhythms: asystole, ventricular fibrillation, ventricular tachycardia, extreme bradycardia, and extreme tachycardia. These events are also displayed on Treatment Summary Reports, Alarm Snapshots, and Continuous Waveform printouts.



The following example shows an Asystole alarm event:



To enable or disable LTA alarms and set Extreme Brady/Tachy alarm limits, you can either do so through the Alarms quick access key (🔔), or the **HR/PR Parameter Control Panel**.

To configure LTA alarms through the Alarms quick access key:

1. Press .
2. Press .
3. Press . Use the navigation keys to highlight and select the fields that you want to change:
  - **LTA Monitoring**
  - **Extreme Brady/Tachy Alarms**

  When you are finished changing values on the alarm menu, navigate to the Backarrow key to confirm your choices and exit the menu.

## Extreme Bradycardia and Extreme Tachycardia Alarm Limits

The Extreme Brady/Tachy Alarm Settings menu specifies the configured delta values that are applied to the HR lower limit alarm and HR upper limit alarm for the Extreme Bradycardia and Extreme Tachycardia LTA alarm detection, respectively. For example, if the HR lower limit alarm is configured to 50 and the Extreme Brady delta value is configured to -10, the Extreme Bradycardia LTA detection threshold will be at 40 bpm. Likewise, if the HR upper limit alarm is configured to 120 and the Extreme Tachy delta value is configured to +20, the Extreme Tachycardia LTA detection threshold will be at 140 bpm. The HR lower and upper limit alarms are not required to be enabled for the Extreme Bradycardia and Extreme Tachycardia LTA alarm detection to be enabled. The Extreme Bradycardia and Extreme Tachycardia LTA alarms will not activate until 20 seconds after the alarm limit threshold is crossed.

The following tables list the default Extreme Bradycardia and Extreme Tachycardia alarm limits for adult, pediatric, and neonate patients, and the ranges in which you can set these limits:

### Extreme Bradycardia Alarm Limits


Patient Type	Default	Delta Value Range
Adult	-10	-5 to -30 in increments of 5
Pediatric	-10	-5 to -30 in increments of 5
Neonate	-10	-5 to -30 in increments of 5

### Extreme Tachycardia Alarm Limits

Patient Type	Default	Delta Value Range
Adult	+20	+5 to +30 in increments of 5
Pediatric	+20	+5 to +30 in increments of 5
Neonate	+20	+5 to +30 in increments of 5

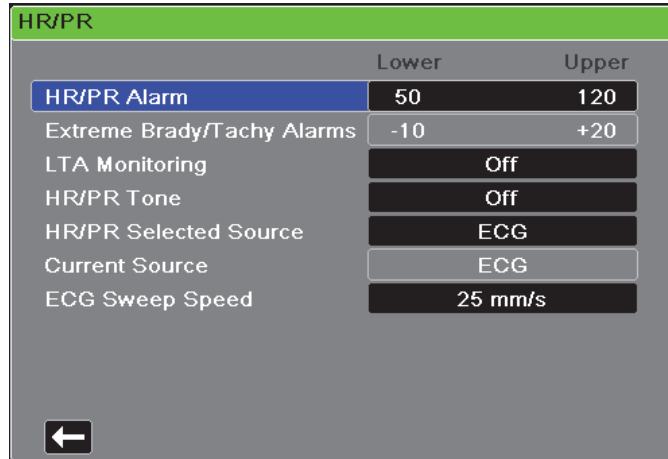
## Acknowledging LTA Alarms

LTA alarms are latching, which means that the alarm indication will persist until both of the following conditions are met:

- The alarm has been acknowledged by pressing the Alarm Pause (Silence)/Reset button  on the front panel of the unit.
- The alarming condition no longer exists.

## Using the Heart Rate Parameter Control Panel

To configure alarms through the Heart Rate Parameter Control Panel, use the navigation keys to highlight and select the Heart Rate meter and display the HR/PR Parameter Control Panel:



**Figure 7-1 HR/PR Parameter Control Panel**

Selecting the **HR/PR Alarm** prompt displays the **HR/PR Alarm Settings** menu, on which you can enable/disable Heart Rate alarms and set alarm limits.

## RESP System Message

When monitoring Respiration using impedance pneumography, the X Series unit may display the following message:

System Message	Cause
<i>RESPIRATION FAULT</i>	The impedance measured through the ECG lead is too high for the unit to detect Respiration changes, but not high enough to indicate an ECG lead fault (the impedance may vary between 1800 and 2800 ohms).

# Chapter 8

## Monitoring Non-Invasive Blood Pressure (NIBP)

---

The X Series NIBP input is Type CF defibrillator proof.

This chapter describes how to use the X Series unit's NIBP option to perform Non-Invasive Blood Pressure (NIBP) measurements using an inflatable cuff to measure arterial pressure.

The X Series uses the enhanced NIBP features of Welch Allyn's SureBP and patented Smartcuf motion-tolerant technology.

The X Series unit must perform ECG monitoring when using Smartcuf.

The SureBP monitoring software allows the X Series unit to take an NIBP measurement as the cuff is inflating, which saves time -- the measurement takes about 15 seconds -- and improves patient comfort.

The Smartcuf monitoring software enables the X Series unit to make accurate NIBP measurements in the presence of extreme artifact, weak pulses, and some dysrhythmias by synchronizing the NIBP measurements with the patient's R-wave.

- Warning!**
- **Observe the patient's limb periodically to ensure that circulation is not impaired for a prolonged period of time.**
  - **Do not place cuff over a wound, as this can cause further injury.**
  - **Do not allow the NIBP tubing to become kinked or crushed. This could prevent normal cuff deflation resulting in patient injury due to prolonged restriction of blood flow.**
  - **Never use the X Series to monitor NIBP on one patient while simultaneously monitoring ECG on another patient.**
  - **If a non-invasive blood pressure measurement is suspect, repeat the measurement. If you are still uncertain about the measurement, use another method.**
  - **Do not use NIBP without proper training.**
  - **Check that the correct patient mode has been selected to ensure that the initial inflation pressure is set correctly. If an over-range indication (+++) occurs when monitoring NIBP on a large or older child, change the patient mode selection from pediatric to adult.**
  - **Patient movement, very low pulse volume, or vibration from outside sources can influence the accuracy of blood pressure measurements.**
  - **Do not attempt to take NIBP measurements on patients during cardiopulmonary bypass procedures.**
  - **Some or all NIBP safety functions are disabled when performing the NIBP test in the Service menu. Do not conduct NIBP tests when the cuff is attached to a patient.**
  - **The effectiveness of this sphygmomanometer has not been established in pregnant, including pre-eclamptic, patients.**
-



## How does NIBP Work?

The blood pressure cuff and hose connect to the X Series unit through the NIBP connector on the side panel of the unit. The NIBP button on the front panel of the unit allows you to initiate and terminate blood pressure measurements, which are displayed in the NIBP area of the monitor.

The X Series unit's NIBP module measures the oscillometric pulses transmitted through the blood pressure cuff and hose, and calculates the blood pressure measurements accordingly. The pressure measurement proceeds as follows:

1. The cuff inflates to a preconfigured pressure (determined by patient type) above the patient's systolic blood pressure. As the cuff inflates, the X Series unit measures the oscillometric pulses transmitted from the cuff through the hose, and the SureBP monitoring software calculates the patient's systolic, diastolic, and mean blood pressure. Once these measurements are taken, the cuff deflates. The X Series unit takes these measurements in about 15 seconds.

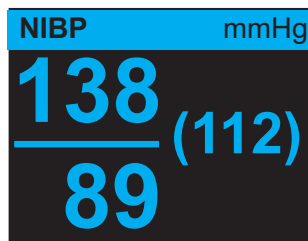
The SureBP feature requires the use of a cuff and dual lumen hose.

2. If high artifact prevents an accurate measurement during cuff inflation, or if you use a cuff and single lumen hose, the cuff inflates to its target pressure to occlude blood flow through the arteries in the monitored limb. The cuff deflates incrementally, allowing blood to flow through the cuff and into the monitored limb. As blood flows through the partially deflated cuff, it produces pressure oscillations that are transmitted to the X Series unit through the hose. The X Series unit measures the oscillometric pulses and uses them to calculate the corresponding systolic, diastolic, and mean blood pressure. This measurement takes about 30 seconds.
3. The NIBP option automatically adjusts the blood pressure measurement procedure in response to certain error conditions such as:

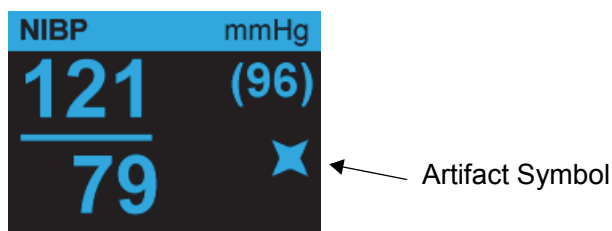
Condition	Adjustment/Response
The unit cannot detect systolic pressure	The unit automatically increases the cuff inflation pressure and completes the blood pressure measurement
The unit cannot detect systolic, diastolic or mean pressure after 180 seconds	The unit aborts the blood pressure measurement and deflates the cuff
The unit detects a fault	The unit displays a corresponding error message on the monitor and aborts the measurement

## The NIBP Numeric Display

When NIBP monitoring has been set up and the X Series unit has begun taking NIBP measurements, the systolic, diastolic, and mean blood pressure measurements appear on the NIBP numeric display as follows:



The Artifact symbol (✱) appears on the NIBP numeric display whenever the X Series unit detects that NIBP measurements (systolic, diastolic, mean) may be inaccurate. The symbol displays when NIBP measurements are below the specified measurement range for the selected patient type or when the accuracy of NIBP measurements may be compromised by the presence of motion artifact, weak pulses, cardiac arrhythmias or other blood pressure artifacts.



**Note:** For a list of system messages that may display on the X Series unit when monitoring NIBP see “NIBP System Messages” on page 8-16.

The following sections describe how to set up NIBP monitoring.

## NIBP Setup and Use

To take safe and accurate NIBP measurements using the X Series unit, you must perform the following steps, each of which corresponds to a section in this chapter. Read each section carefully before you perform NIBP measurements.

1. Select the correct size cuff.
2. Apply the cuff to the patient.
3. Connect the inflation hose to the X Series unit and to the cuff.
4. Configure NIBP alarms and settings (if the current NIBP alarms and settings are not appropriate).
5. Press the NIBP button on the X Series unit’s front panel and take the blood pressure measurement.

## Selecting the NIBP Cuff

To take accurate measurements, you must use the proper sized cuff: the cuff's bladder length should be at least 80 percent of the limb circumference, while the cuff width should be equal to 40 percent of the limb circumference.

**Caution** Use only hoses and cuffs that are approved by ZOLL Medical Corporation. See Appendix B, *Accessories*, for a listing of the approved hoses and cuffs. Use the following guidelines when selecting the appropriate hose and cuff:

	<b>Adult Mode</b>	<b>Pediatric Mode</b>	<b>Neonate Mode</b>
<b>Cuffs</b> (typical cuff labeling)	Adult, Large Adult, Small Adult, Child, Thigh	Child, Small Child, Small Adult, Infant, Newborn	Neonate #1 to #5 -- disposable Newborn (#6), Infant (#7) -- reusable
<b>Recommended Limb Circumference</b>	15 cm or greater.	7.7 to 25 cm	15 cm or less
<b>Hoses</b>	Adult	Adult	Neonate/Infant (Disposable Cuff only) * Reusable Newborn (#6) and Infant (#7) cuffs use the Adult Hose.

**Caution** Selection of the correct cuff is critical to the accuracy of NIBP measurements. Using a cuff that is too small results in measurements higher than the patient's actual blood pressure. Using a cuff that is too large results in measurements lower than the patient's actual blood pressure.

The X Series unit uses the same definitions of Neonates, Pediatrics, and Adults as defined in the AAMI SP10:2002 standard:

**Neonate or Newborn** Children 28 days or less of age if born at term (37 weeks gestation or more); otherwise, up to 44 gestational weeks

**Pediatric but not Neonate** Individuals between 29 days and 12 years of age

**Adult** Individuals greater than 12 years of age

## Connecting the NIBP Cuff

Connecting the NIBP cuff requires you to attach the inflation hose to the X Series unit and the NIBP cuff. To use the SureBP feature, which enables the X Series unit to measure blood pressure on cuff inflation, you must use the FlexiPort cuff and dual lumen (two-tube) adaptor and hose. You can also use a single lumen (one-tube) hose and adaptor with the X Series unit, but the unit will only measure blood pressure on cuff deflation.

To connect the NIBP cuff to the X Series unit:

1. Attach the inflation hose's threaded metal connector to the NIBP connector on the side panel of the X Series unit. Mesh the threads carefully so that the connector turns easily and then turn the connector in a clockwise direction until it is snug. Attach a double lumen hose as follows:



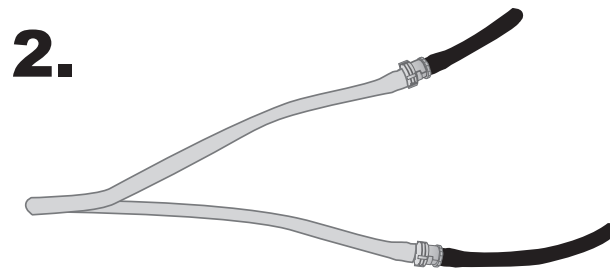
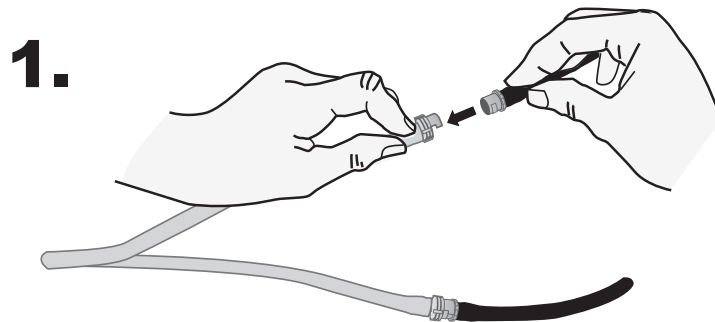
**Figure 8-1 Attaching a Dual Lumen Hose to the X Series Unit**

Attach a single lumen hose as follows:



**Figure 8-2 Attaching Single Lumen Hose to the X Series Unit**

2. Insert the plastic connectors on the NIBP hose into the cuff hose connector, and twist the connectors until they lock. The connectors are the same; you can insert either of the plastic connectors into either of the cuff hose connectors in any order.



## Applying the Cuff to the Patient

To apply the cuff to the patient:

1. Ensure the patient is lying down or comfortably seated with legs uncrossed, both feet on the floor, and back supported. The limb to be used for NIBP measurement should be relaxed, extended, and placed on a smooth surface for support. The operator position is not restricted during NIBP measurement.
2. Squeeze as much air from the cuff as possible before placing it on the patient.
3. Place the cuff 2 to 5 cm above the elbow crease or 5 to 10 cm (1.9 to 3.9 in.) above the knee crease.

---

**Warning!**

- **Do not place the NIBP cuff on the same arm or leg as an SpO<sub>2</sub> sensor. Inflation of the cuff causes the SpO<sub>2</sub> monitor to read incorrectly.**

- **Do not attach the cuff to a limb being used for IV infusion. Cuff inflation might block the infusion, causing harm to the patient.**

- **Do not place cuff over a wound, as this can cause further injury.**
- 

4. Adjust the cuff so that the artery marker on the cuff is over the artery, pointing to the hand or foot.
5. Check that the cuff ends between the range lines marked on the cuff.
6. If they do not line up, use a different size cuff.
7. Wrap the deflated cuff snugly around the limb without impeding blood flow.
8. Ensure that the hose is routed to avoid kinking or compression.

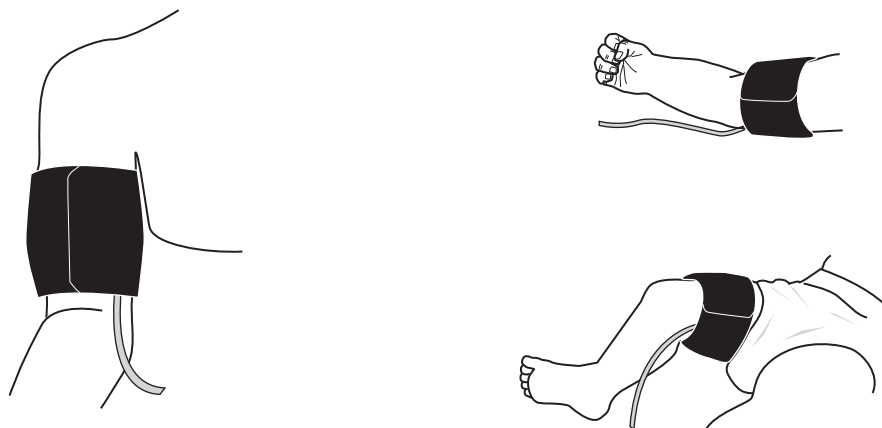
---

**Caution**

- Using a cuff that is loosely applied or too small results in measurements higher than the patient's actual blood pressure.
- Using a cuff that is too large results in values lower than the patient's actual blood pressure.
- Ideally, the cuff should be at the same level as the heart. Cuff placement substantially above or below heart level will result in blood pressure measurements that are erroneously low or high.

---

The following illustrates one possible cuff placement for adult/pediatric patients and, to the right, possible cuff placements for neonates:



**Figure 8-3 Applying Cuff to the Patient**

## Ensuring Correct Cuff Inflation Settings

Before taking an NIBP measurement for a new patient, ensure that the cuff inflation settings are appropriate for that patient.

Check that the correct patient mode is selected. The initial Cuff Inflation Target (CIT) pressure is dependent on the patient type and the configured CIT preset. The default and configurable CIT presets for each patient type are indicated in the following table (default values are in bold).

**Note:** You can configure the CIT pressure from the Setup>NIBP menu.

Adult	Pediatric	Neonate
120 mmHg	80 mmHg	60 mmHg
140 mmHg	90 mmHg	70 mmHg
<b>160 mmHg</b>	100 mmHg	80 mmHg
180 mmHg	110 mmHg	<b>90 mmHg</b>
200 mmHg	<b>120 mmHg</b>	100 mmHg
220 mmHg	130 mmHg	110 mmHg
240 mmHg	140 mmHg	120 mmHg
260 mmHg	150 mmHg	130 mmHg

In order to accurately measure systolic pressure, the CIT pressure must be high enough to occlude the underlying artery. However, setting the CIT pressure too high may unnecessarily increase the reading determination time and patient discomfort.

After each NIBP measurement, the X Series unit adjusts the cuff inflation pressure to optimize the next NIBP measurement.

**Note:** The maximum cuff inflation pressure for neonates is 153 mmHg.

---

**Warning!** Before using the X Series unit to monitor a new patient, power down the unit for *at least 2 minutes* to reset all patient parameters and eliminate all adjustments made for the previous patient.

---




# Configuring NIBP Alarms and Settings

The last step in preparing to perform NIBP measurements is to ensure that the necessary alarms are enabled (or disabled), that alarm limits are appropriate, and that the NIBP settings are correct.




## Enabling/Disabling NIBP Alarms and Setting Alarm Limits

When enabled, the X Series unit sounds alarms whenever measurements are outside set limits for the following:

- High and Low Systolic Pressure
- High and Low Diastolic Pressure
- High and Low Mean Arterial Pressure (MAP)

To enable (or disable) NIBP alarms and set upper and lower alarm limits, you can do so through the Alarms quick access key () or the **NIBP Parameter Control Panel**.

To configure NIBP alarm limits through the Alarms quick access key:

1. Press the More quick access key ()
2. Press the Alarms quick access key ()
3. Press the **Limits** quick access key ()
4. Use the navigation keys to highlight and select the appropriate alarm menu selection. For NIBP, the alarm menu selections are **NIBP Systolic Alarm**, **NIBP Diastolic Alarm**, and **NIBP MAP Alarm**.
5. On the selected NIBP alarm settings menu, use the navigation keys to select the fields that you want to change. The fields are
  - **Upper Limit Enable**
  - **Lower Limit Enable**
  - **Upper Limit**
  - **Lower Limit**
6. When you are finished changing values on the alarm settings menu, select the back arrow to exit the menu.



### Setting Upper and Lower Systolic Alarm Limits

Initially, the **NIBP Systolic Alarm Settings** menu specifies that the NIBP systolic pressure alarms are enabled (**ON**) or disabled (**OFF**), and displays the default upper and lower systolic limits. The upper and lower limits can be **ON** or **OFF** (default is **OFF**). The following table lists the default NIBP Systolic limits for adult, pediatric, and neonate patients, and gives the range in which you can set these limits:

Patient Type	NIBP Systolic Limit Default	NIBP Systolic Limit Range
Adult	Lower: 75 mmHg Upper: 220 mmHg	Lower: 30-258 mmHg Upper: 32-260 mmHg
Pediatric	Lower: 75 mmHg Upper: 145 mmHg	Lower: 30-158 mmHg Upper: 32-160 mmHg
Neonate	Lower: 50 mmHg Upper: 100 mmHg	Lower: 20-118 mmHg Upper: 22-120 mmHg

### Setting Upper and Lower Diastolic Alarm Limits

Initially, the **NIBP Diastolic Alarm Settings** menu specifies that the NIBP diastolic pressure alarms are enabled (**ON**) or disabled (**OFF**), and displays the default Upper and Lower diastolic limits. The upper and lower limits can be **ON** or **OFF** (default is **OFF**). The following table lists the default diastolic limits for adult, pediatric, and neonate patients, and gives the range in which you can set these limits:

Patient Type	Diastolic Limit Default	Diastolic Limit Range
Adult	Lower: 35 mmHg Upper: 110 mmHg	Lower: 20-218 mmHg Upper: 22-220 mmHg
Pediatric	Lower: 35 mmHg Upper: 100 mmHg	Lower: 20-128 mmHg Upper: 22-130 mmHg
Neonate	Lower: 30 mmHg Upper: 70 mmHg	Lower: 10-108 mmHg Upper: 12-110 mmHg

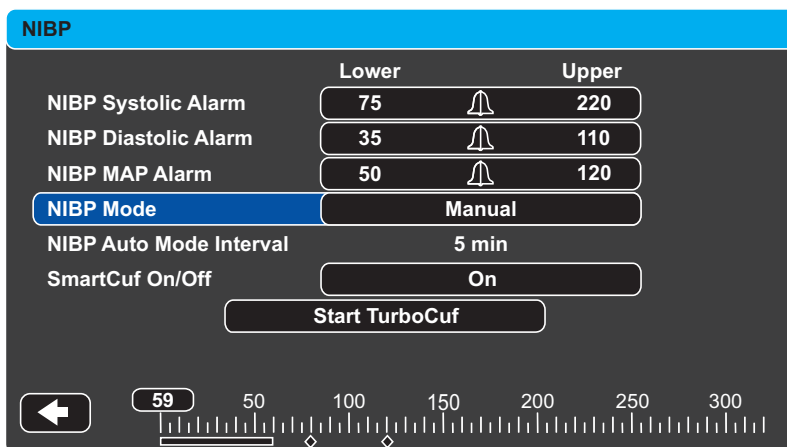
### Setting Upper and Lower NIBP MAP Alarm Limits

Initially, the **NIBP MAP Alarm Settings** menu specifies that **NIBP MAP** alarms are enabled (**ON**) or disabled (**OFF**), and displays the default Upper and Lower MAP limits. The upper and lower limits can be **ON** or **OFF** (default is **OFF**). The following table lists the default MAP alarm limits for adult, pediatric, and neonate patients, and gives the range in which you can set these limits:

Patient Type	MAP Default	MAP Range
Adult	Lower: 50 mmHg Upper: 120 mmHG	Lower: 25-230 mmHg Upper: 23-228 mmHg
Pediatric	Lower: 50 mmHg Upper: 110 mmHg	Lower: 25-140 mmHg Upper: 23-138 mmHg
Neonate	Lower: 35 mmHg Upper: 80 mmHg	Lower: 15-110 mmHg Upper: 13-108 mmHg

## Using the NIBP Parameter Control Panel

Use the navigation keys to highlight and select the NIBP numeric display to display the **NIBP Parameter Control Panel**:



**Figure 8-4 NIBP Parameter Control Menu**

On the NIBP Parameter Control Panel, you can select an alarm configuration option (**SYS**, **DIA**, or **MAP**) to enable/disable alarms and set high and low alarm limits (as described previously).

You can also configure these NIBP options:

- NIBP Mode (**Mode**)
- NIBP Automatic Measurement Interval (**Auto Interval**)
- Enable/Disable Smartcuf motion artifact filter (**Smartcuf**)
- Start/Stop Turbocuf Measurements (**Turbocuf**)

### Specify NIBP Mode

You can specify that the X Series unit operate in either *Manual* or *Automatic Mode*.

In Manual Mode, the X Series unit takes a single NIBP measurement when you press the NIBP button on the front panel (👉). To repeat the NIBP measurement, you must press the NIBP key again (select **Manual**).

In Automatic Mode, the X Series unit takes the first of a series of NIBP measurements when the **Auto Interval** timer expires, and then repeats the NIBP measurement at this specified interval.

**Note:** You can press the NIBP button and manually initiate an NIBP reading at any time while in Automatic Mode. Manually initiated NIBP readings will not affect the timing of subsequent NIBP readings in Automatic Mode.

### Specify the Automatic NIBP Measurement Interval

You can specify the time interval between NIBP measurements in Automatic Mode. The default interval between measurements is 5 minutes.

You can specify intervals of **1, 2, 3, 5, 10, 15, 30, and 60** minutes between NIBP measurements.

## Enable/Disable Smartcuf Motion Artifact Filter

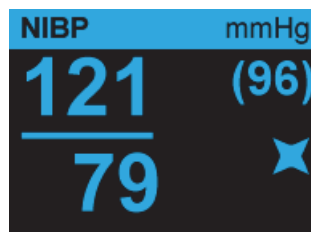
Enabling the use of the Smartcuf motion artifact filter increases the accuracy of NIBP measurements when motion artifact or weak pulses are present.

NIBP measurements can be adversely affected by many factors, such as cardiac arrhythmias, sudden changes in blood pressure, body motions such as shivering and convulsions, bumping the cuff, vibration, vehicle motion, or weak pulses. The Smartcuf filter synchronizes the NIBP reading with the R-wave of the patient's ECG to eliminate noise created by patient motion or vibration.

**Note:** The X Series unit must perform ECG monitoring when using Smartcuf.

If artifact is severe, a special symbol appears on the display and printouts:

**Figure 8-5 High Artifact Symbol**



By default, Smartcuf is **Enabled**.

There are situations where you may choose to disable Smartcuf. These may include

- Very extreme motion artifact
- Certain types of arrhythmias
- Situations that prevent getting a ECG signal.

NIBP measurements can still be performed with Smartcuf disabled.

## Start/Stop TurboCuf

Selecting **Start TurboCuf** starts Short-term Automatic (STAT) NIBP measurements. The X Series unit begins its first NIBP measurement, after which it continues to perform as many NIBP measurements as possible over a 5-minute period.

Select **Stop TurboCuf** to immediately stop STAT measurements.

---

**WARNING!** Repeated use of STAT measurements on the same patient over a short time interval can affect blood pressure readings, limit circulation to the limb, and cause injury to the patient.

---

## Setting the NIBP Display Format

You can specify the appearance of the NIBP numeric display format. The display format allows you to choose whether or not you will display MAP measurement (**M**) with the Systolic (**S**) and Diastolic (**D**) measurements in one of the following formats:

- **S/D**
- **S/D (M)** (default display)
- **(M) S/D**

**Note:** If a MAP alarm is active when the **S/D** format is selected, the display format will be **S/D (M)** until you clear the MAP alarm.

## NIBP System Messages

When monitoring NIBP, the X Series unit may display the following messages:

<b>System Message</b>	<b>Cause</b>
<i>READING IN PROGRESS</i>	The unit is taking an NIBP measurement and functioning normally.
<i>READING STOPPED</i>	The unit has stopped an NIBP measurement, because the operator has pressed the NIBP button and cancelled the measurement.
<i>READING FAILED</i>	The patient's pulse is too weak to obtain an NIBP measurement, or the cuff requires adjustment.
<i>ARTIFACT</i>	Excessive artifact is preventing the NIBP measurement. If ECG is available, consider turning SmartCuf on.
<i>NEONATE ALERT</i>	The unit has detected a neonate cuff when in Adult mode. Replace cuff or correct patient mode, as appropriate. If the detection is in error, dismiss the alert and reattempt the NIBP measurement.
<i>AIR LEAK</i>	A major air leak is preventing cuff inflation. Check hose and cuff connections, replace a defective hose or cuff, as necessary, and reattempt NIBP measurement.
<i>KINKED HOSE</i>	An air obstruction is preventing the correct operation of the unit. Check hose for kinks. If using a dual lumen hose, verify the correct placement of the O ring on the hose connector. Eliminate kinks or replace hose, if necessary.
<i>NIBP DISABLED</i>	A system error has occurred, and the X Series unit should be serviced.
<i>NIBP CALIBRATION CHECK DUE</i>	The annual calibration check is due. You can continue to use the device, however, we recommend that you contact your trained specialist or the ZOLL Technical Service Department or a ZOLL authorized service representative as soon as possible to perform the recommended annual NIBP calibration check.
<i>PLEASE WAIT</i>	After completing an NIBP request in Automatic mode or STAT (TurboCuf) mode, the unit must wait up to 30 seconds before initiating the next NIBP measurement request.

---

<b>System Message</b>	<b>Cause</b>
<i>PRESS. LIMIT EXCEEDED</i>	The cuff pressure has exceeded the allowable limit. Restrict patient movement and check the hose for kinks. Eliminate kinks or replace the hose, if necessary.
<i>TEMP OUT OF RANGE</i>	The NIBP module is outside of its operating temperature range. Move unit to proper operating temperature and reattempt the NIBP measurement.
<i>WEAK PULSE</i>	The patient's pulse is too weak to obtain an NIBP measurement or the cuff requires adjustment.





# Chapter 9

## Monitoring CO<sub>2</sub>

---

This chapter describes how to use the X Series unit to monitor End Tidal Carbon Dioxide (EtCO<sub>2</sub>), breath rate, and Fractional Inspired Carbon Dioxide (FiCO<sub>2</sub>). These options use the same connector on the X Series unit and may be used interchangeably.

### Overview

The X Series unit uses the Oridion Microstream FilterLine<sup>®</sup> and Smart CapnoLine<sup>®</sup> sidestream systems to monitor CO<sub>2</sub>.

The FilterLine and Smart CapnoLine sidestream systems draw small samples of gas from the patient's airway via a nasal/oral cannula or airway adapter, and pass these gases through a solid state infrared sensor (located away from the patient's airway) that measures CO<sub>2</sub>. The Microstream system can be used for CO<sub>2</sub> measurements on intubated and non-intubated infant, pediatric, and adult patients.

The Microstream CO<sub>2</sub> sensor generates infrared light, and beams it through the sampled breathing gases and determines CO<sub>2</sub> concentration by measuring the amount of light absorbed by gases.

The X Series unit displays EtCO<sub>2</sub> (the concentration of carbon dioxide detected at the end of each exhalation) and FiCO as a numerical value in millimeters of mercury (mmHg). In addition, the unit can display a capnogram. The capnogram is a valuable clinical tool that can be used to assess patient airway integrity and proper endotracheal (ET) tube placement. The unit calculates respiration rate by measuring the time interval between detected peaks of the CO<sub>2</sub> waveform. The technology differentiates between waveforms caused by breathing and those caused by cardiogenic oscillations and artifact.

The X Series is equipped with automatic barometric pressure compensation.

- Warning!**
- **When using a sampling line for intubated patients with a closed suction system, do not place the airway adapter between the suction catheter and endotracheal tube. This is to ensure that the airway adapter does not interfere with the functioning of the suction catheter.**
  - **Do not cut or remove any part of the sample line. Cutting the sample line could lead to erroneous readings**
  - **If too much moisture enters the sampling line (i.e., from ambient humidity or breathing of unusually humid air), the message *Clearing FilterLine* will appear in the message area. If the sampling line cannot be cleared, the message *FilterLine Blockage* will appear in the message area. Replace the sampling line once the *FilterLine Blockage* message appears.**
  - **Do NOT use the Microstream sidestream CO<sub>2</sub> accessories in the presence of flammable anesthetics or other flammable gases.**
  - **Loose or damaged connections may compromise ventilation or cause an inaccurate measurement of respiratory gases. Securely connect all components and check connections for leaks according to standard clinical procedures.**
  - **Always ensure the integrity of the patient breathing circuit after insertion of the airway adapter by verifying a proper CO<sub>2</sub> waveform (capnogram) on the monitor display.**
- 

**Caution** Microstream<sup>®</sup> EtCO<sub>2</sub> sampling lines are designed for single patient use, and are not to be reprocessed. Do not attempt to clean, disinfect, sterilize or flush any part of the sampling line as this can cause damage to the monitor.


Dispose of sampling lines according to standard operating procedures or local regulations for the disposal of contaminated medical waste.

Before use, carefully read the Microstream EtCO<sub>2</sub> sampling line's *Directions for Use*.

---

## CO<sub>2</sub> Monitoring Setup and Use

Follow these steps to set up CO<sub>2</sub> monitoring:

1. Select the correct CO<sub>2</sub> sampling line for the patient.
2. Attach the sampling line to the unit's CO<sub>2</sub> inlet port.
3. Apply the Filterline airway adaptor or Smart CapnoLine Nasal or Nasal/Oral cannula to the patient.
4. Check that the X Series unit is set up for the correct patient type -- Adult, Pediatric, or Neonate.
5. Configure alarms (if the current alarm settings are not appropriate) and other CO<sub>2</sub> features.
6. Press the CO<sub>2</sub> quick access key () to initiate CO<sub>2</sub> monitoring.

## Selecting the CO<sub>2</sub> Sampling Line

To select the correct CO<sub>2</sub> sampling line, you must determine the following:

- Is the patient adult, pediatric, or neonate?
- Is the patient intubated (ventilated) or non-intubated (non-ventilated)?

You can use the following Oridion Microstream accessories for sidestream CO<sub>2</sub> monitoring with the X Series unit:

**Table 7-1. Oridion Microstream CO<sub>2</sub> Sampling Lines for use with X Series units.**

Accessory	Type	Part Number
FilterLine Set (Adult/Pediatric), box of 25	Intubated sampling line and airway adapter for short term monitoring	8300-0520-01
FilterLine H Set (Adult/Pediatric), box of 25	Intubated sampling line and airway adapter for humid environments	8300-0521-01
FilterLine H Set (Infant/Neonate), box of 25	Intubated sampling line and airway adapter for humid environments	8300-0522-01
VitaLine H Set (Adult/Pediatric), box of 25	Intubated sampling line and airway adapter for high ambient humidity	8300-0523-01
Smart Capnoline Plus with O <sub>2</sub> (Adult), box of 25	Non-Intubated Oral/ Nasal sampling with O <sub>2</sub> delivery	8300-0524-01
Smart Capnoline Plus with O <sub>2</sub> (Pediatric), box of 25	Non-Intubated Dual Purpose	8300-0525-01

---

**Warning!** To ensure safe and reliable operation including biocompatibility, use only Microstream CO<sub>2</sub> accessories.

---

## Connecting the CO<sub>2</sub> Sampling Lines

To connect the FilterLine or Smart CapnoLine:

1. Slide open the X Series unit's CO<sub>2</sub> inlet port cover.
2. Put the fitting at the end of the sidestream tubing over the CO<sub>2</sub> inlet port connector.
3. Turn the fitting clockwise to tighten.



**Figure 9-1 Connecting the Sampling Line Connector to the CO<sub>2</sub> Inlet Port**

- 
- WARNING!**
- **The exhaust port for the Microstream sidestream CO<sub>2</sub> apparatus is an output for only expired gases from the patient and any connected breathing apparatus. The exhaust port is intended only for connection to gas collection equipment, such as gas scavenger devices -- *there should be no other connections to the exhaust port.***
  - **When connecting the Microstream sidestream CO<sub>2</sub> accessory to patients who are receiving or have recently received anesthetics, connect the CO<sub>2</sub> exhaust port to a scavenging system, or to the patient's anesthetic machine or ventilator to prevent exposing medical staff to anesthetics.**
  - **Do not lift the monitor by the FilterLine, as it could disconnect from the monitor, causing the monitor to fall on the patient.**
  - **The FilterLine may ignite in the presence of high O<sub>2</sub> concentrations when directly exposed to laser or ESU devices. Use caution when performing these procedures.**
- 

**Note:** If you use a gas scavenging system, ensure that it is installed according to the manufacturer's instructions. The gas scavenging system should comply with ISO 8835-3:1997 (E).

**Note:** In order to avoid moisture buildup and sampling line occlusion during nebulization or suction for intubated patients, remove the sampling line luer connector from the monitor.

## Applying a FilterLine Set

The FilterLine set is intended for the CO<sub>2</sub> monitoring of intubated patients.

Before attaching the airway adapter to the breathing circuit, verify that the adapter is clean, dry, and undamaged. Replace if necessary.

---

**Caution** The disposable FilterLine set is intended for single patient use. Do NOT reuse or sterilize any part of the FilterLine Set, as the monitor may be damaged by cleaning or reuse.

---

1. Place the airway adapter at the proximal end of the airway circuit between the elbow and the ventilator circuit wye. Do NOT place the airway adapter between the ET tube and the elbow as this may allow patient secretions to accumulate in the adapter.
2. If pooling does occur, the airway adapter may be removed from the circuit, rinsed with water and reinserted into the circuit. To prevent moisture from draining into the sample tubing, ensure that the sampling tube exits from the top of the airway adapter, not its bottom or sides. See the following figure.

## Applying a Smart CapnoLine Nasal or Nasal/Oral Cannula

The nasal and nasal/oral cannulas are intended for monitoring CO<sub>2</sub> in non-intubated patients.

Oral/nasal sampling cannulas are especially valuable for patients who are prone to mouth breathing, since most (if not all) of the CO<sub>2</sub> is exhaled through the mouth. If a standard nasal CO<sub>2</sub> sampling cannula is used on such patients, the EtCO<sub>2</sub> values and capnogram displayed will be substantially lower than the actual CO<sub>2</sub> levels present in the patient's expired breath.

- 
- WARNING!**
- **The disposable Smart CapnoLine nasal and nasal/oral cannula sets are intended for single patient use. Do NOT reuse or sterilize any part of this product, as the monitor may be damaged by reuse of the sampling line.**
  - **If oxygen is being delivered while using sidestream CO<sub>2</sub>, be sure to use a CO<sub>2</sub> sampling with O<sub>2</sub> delivery. Using a different type of cannula will not enable oxygen delivery.**
- 

Remove the cannula from the package. Verify that the cannula is clean, dry, and undamaged. Replace if necessary.

### Placing the Cannula onto the Patient

Place the oral/nasal cannula onto the patient as follows:




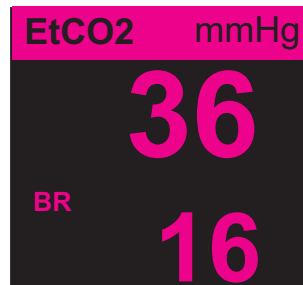
---

**Caution** Dispose of Microstream EtCO<sub>2</sub> consumables according to standard operating procedures or local regulations for the disposal of contaminated medical waste.

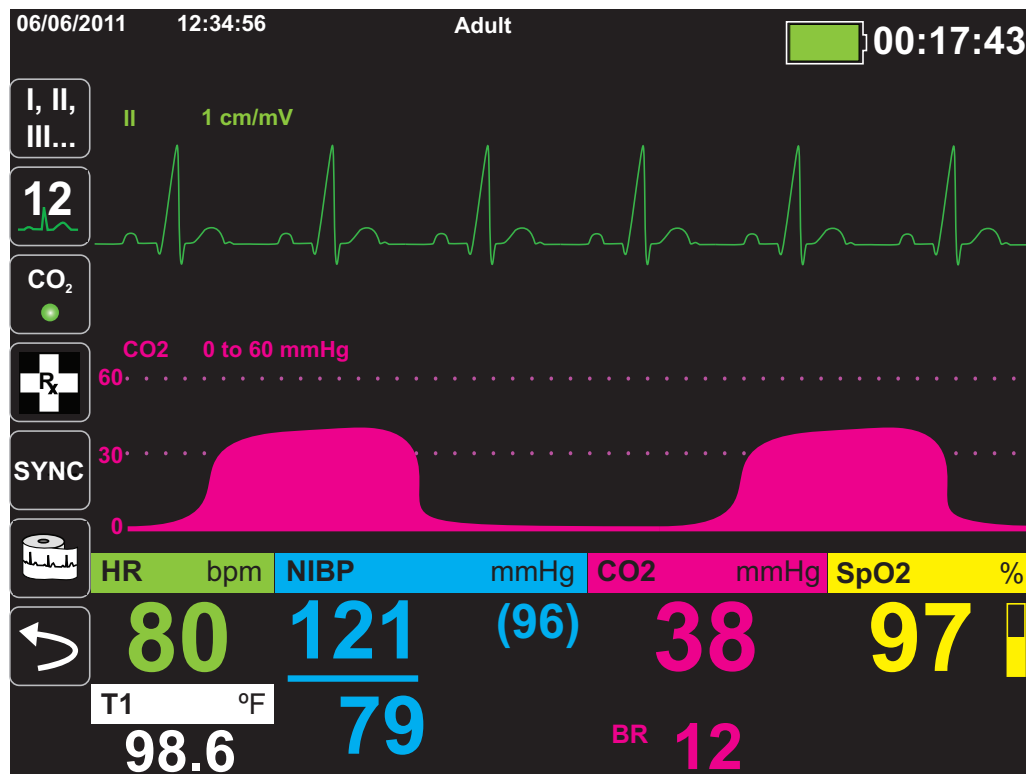
---

## Measuring CO<sub>2</sub>

Once setup is complete, press  to begin monitoring CO<sub>2</sub>. The numeric CO<sub>2</sub> display appears on the screen and displays the message, *INITIALIZING*. The CO<sub>2</sub> display gives the current EtCO<sub>2</sub> value, and after a delay of approximately 1 minute, the patient's Respiration Rate (in Breaths/Minute), identified as **BR**:



Check that connections have been made correctly by verifying the display a proper capnogram (the waveform is inserted automatically on the waveform display window).




## Setting CO<sub>2</sub> and Respiration Rate Alarms

The X Series unit sounds alarms whenever measurements are outside set limits for the following:





- High and Low EtCO<sub>2</sub>
- High and Low Respiration Rate (in Breaths/Minute)
- High FiCO<sub>2</sub>
- No Breath Alarm

**Note:** Use the Resp Parameter Control Panel to set the duration of the No Breath Alarm, or to disable it (see “Using the Resp Parameter Control Panel” on page 7-4).

### Enabling/Disabling Alarms and Setting CO<sub>2</sub> Alarm Limits

You can enable (or disable) CO<sub>2</sub> alarms and set upper and lower alarm limits through the Alarms quick access key () or the CO<sub>2</sub> Parameter Control Panel.

To configure CO<sub>2</sub> alarms through the Alarms quick access key:

1. Press the More quick access key ()
2. Press .
3. Press the **Limits** quick access key ()
4. Use the navigation buttons to select appropriate alarm menu. For CO<sub>2</sub>, the alarm menus are: EtCO<sub>2</sub> Alarm, FiCO<sub>2</sub> Alarm, or RR/BR Alarm.
5. On the alarm settings menu, use the navigation keys to select the fields that you want to change. The fields are
  - **Upper Limit Enable**
  - **Lower Limit Enable (only EtCO<sub>2</sub> and RR/BR Alarms)**
  - **Upper Limit**
  - **Lower Limit (only EtCO<sub>2</sub> and RR/BR Alarms)**
6.  When you are finished changing values on the alarm menu, select the Backarrow key to exit the menu.



### Setting Upper and Lower EtCO<sub>2</sub> Limits

Initially, the EtCO<sub>2</sub> Alarm menu specifies that the EtCO<sub>2</sub> alarms are enabled (**ON**) or disabled (**OFF**), and displays the default Upper and Lower EtCO<sub>2</sub> Limits. The upper and lower limits can be **ON** or **OFF** (default is **OFF**). The following table lists the default EtCO<sub>2</sub> limits for adult, pediatric, and neonate patients, and gives the range in which you can set these limits:

Patient Type	EtCO <sub>2</sub> Limit Default	EtCO <sub>2</sub> Limit Range
Adult	Lower: 8 mmHg Upper: 60 mmHg	Lower: 0-145 mmHg Upper: 5-150 mmHg
Pediatric	Lower: 8 mmHg Upper: 60 mmHg	Lower: 0-145 mmHg Upper: 5-150 mmHg
Neonate	Lower: 8 mmHg Upper: 60 mmHg	Lower: 0-145 mmHg Upper: 5-150 mmHg

#### Caution

In high-altitude environments, EtCO<sub>2</sub> values may be lower than values observed at sea level, as described by Dalton's law of partial pressures. When using the X Series unit in high-altitude environments, it is advisable to adjust EtCO<sub>2</sub> alarm settings accordingly.

### Setting Upper FiCO<sub>2</sub> Limits

Initially, the FiCO<sub>2</sub> Alarm menu specifies that the FiCO<sub>2</sub> alarms are enabled (**ON**) or disabled (**OFF**), and displays the default upper limit. The upper limit can be **ON** or **OFF** (default is **OFF**). The following table lists the default FiCO<sub>2</sub> upper limits for adult, pediatric, and neonate patients, and gives the range in which you can set these limits:

Patient Type	Upper FiCO <sub>2</sub> Limit Default	Upper FiCO <sub>2</sub> Limit Range
Adult	8 mmHg	2-98 mmHg
Pediatric	8 mmHg	2-98 mmHg
Neonate	8 mmHg	2-98 mmHg

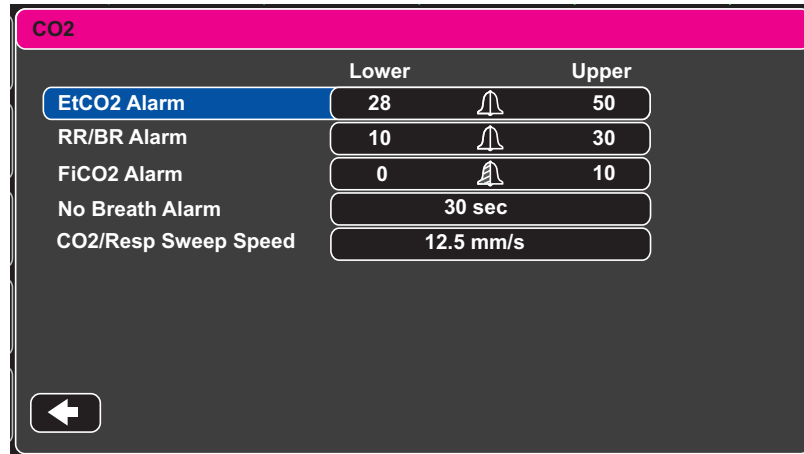
### Setting Upper and Lower Respiratory Rate (RR/BR) Limits

Initially, the RR/BR Alarm menu specifies that RR/BR alarms are enabled (**ON**) or disabled (**OFF**), and displays the default Upper and Lower respiratory limits. The upper and lower limits can be **ON** or **OFF** (default is **OFF**). The following table lists the default Respiratory limits for adult, pediatric, and neonate patients in Breaths/Minute, and gives the range in which you can set these limits:

Patient Type	Respiration Rate Default	Respiration Rate Range
Adult	Lower: 3 BPM Upper: 50 BPM	Lower: 0 to 145 BPM Upper: 5 to 150 BPM
Pediatric	Lower: 3 BPM Upper: 50 BPM	Lower: 0 to 145 BPM Upper: 5 to 150 BPM
Neonate	Lower: 12 BPM Upper: 80 BPM	Lower: 0 to 145 BPM Upper: 5 to 150 BPM

### Using the CO<sub>2</sub> Parameter Control Panel

Use the navigation keys to highlight and select the **CO<sub>2</sub>** numeric display to display the CO<sub>2</sub> Parameter Control Panel:



On the CO<sub>2</sub> Parameter Control Panel, you can select a CO<sub>2</sub> alarm (EtCO<sub>2</sub>, Breath Rate, or FiCO<sub>2</sub>). On the selected alarm settings menu, you can enable/disable alarms and set alarm limits (as described previously). You can also set the CO<sub>2</sub> sweep speed.

### Setting the CO<sub>2</sub> Sweep Speed

The EtCO<sub>2</sub> sweep speed determines the X-axis scale of the capnogram. For patients with slower respiration rates, a slower sweep speed will make the capnogram easier to view. You can specify sweep speeds of 3.13, 6.25, and 12.5 mm/second. The default sweep speed is 6.25 mm/second.

## CO<sub>2</sub> System Messages

When monitoring CO<sub>2</sub>, the X Series unit may display the following messages:

System Message	Cause
<i>INITIALIZING</i>	The unit is initializing the CO <sub>2</sub> monitoring function measurement, is functioning normally, and will display CO <sub>2</sub> measurement after a brief delay.
<i>CHECK FILTERLINE</i>	The sampling line is not connected. Check sampling line connection. Replace airway adaptor or cannula, if defective.
<i>FILTERLINE OCCLUSION</i>	The sampling or exhaust line is blocked. Check sampling and exhaust lines. Make sure that the sampling line and any inputs to the patient breathing apparatus are not connected to the exhaust port. If the current FilterLine is correctly attached, replace the FilterLine.
<i>AUTO ZERO</i>	The X Series unit displays <i>AUTO ZERO</i> when the CO <sub>2</sub> module performs periodic self-maintenance. During self-maintenance, the CO <sub>2</sub> module performs one or more of the following tests: ambient pressure measurement, auto zero, and a flow test. The CO <sub>2</sub> module completes its self-maintenance tests in approximately 10 seconds.
<i>PURGING</i>	The CO <sub>2</sub> module performs a purging whenever it detects an occlusion in the line or airway adaptor, and displays <i>PURGING</i> while it tries to clear the occlusion. If the CO <sub>2</sub> module cannot clear the occlusion within 30 seconds, the X Series unit issues an equipment alert and displays the message <i>FILTERLINE OCCLUSION</i> . At this point, if the current FilterLine is correctly attached, replace the FilterLine.
<i>VALUE OVER RANGE</i>	The CO <sub>2</sub> value exceeds the specified range.
<i>CO2 DISABLED</i>	An error has occurred with the CO <sub>2</sub> module, and the X Series unit has disabled the module for the duration of the unit's power cycle. If the problem persists, the unit may require servicing.
<i>CO2 MONITORING FAILURE</i>	The X Series unit has determined that the CO <sub>2</sub> module is not functioning correctly. If the problem persists, the unit may require servicing.

## Patents

The capnography component of the X Series unit is covered by one or more of the following US patents: 6,428,483; 6,997,880; 5,300,859; 6,437,316; 7,488,229; and their foreign equivalents. Additional patent applications pending.

### **NO IMPLIED LICENSE**

Possession or purchase of this device does not convey any express or implied license to the device with unauthorized consumable CO<sub>2</sub> sampling consumable products, which would, alone, or in combination with this device, fall within the scope of one or more of the patents relating to this device and/or CO<sub>2</sub> sampling consumable products.

# Chapter 10

## Pulse CO-Oximetry (SpO<sub>2</sub>)

---

The X Series SpO<sub>2</sub> input is Type CF defibrillator proof.

This chapter describes how to use the X Series unit to monitor Pulse CO-Oximetry (SpO<sub>2</sub>), as well as the optional features: SpCO, and SpMet, and SpHb, SpOC PVI, and PI.

The X Series pulse CO-Oximeter continuously and noninvasively measures the following at a peripheral site, such as the foot, toe, or finger:

- Oxygen saturation of arterial hemoglobin (SpO<sub>2</sub>)
- Carboxyhemoglobin saturation (SpCO)
- Methemoglobin saturation (SpMet)
- Total Hemoglobin (SpHb)
- Oxygen Content (SpOC)
- Pleth Variability Index (PVI)
- Perfusion Index (PI)

This monitoring gives information about the cardiac and respiratory systems, and provides details of oxygen transportation in the body. It is widely used because it is noninvasive, continuous, easily applied, and painless.

The X Series pulse CO-oximetry option is intended for use only with ZOLL / Masimo Rainbow sensors. The CO-oximetry sensor contains light-emitting diodes (LEDs) that transmit various visible and infrared light through the body's extremities. The transmitted light is then received by a photodetector, which converts it to an electronic signal. The signal is then sent to the X Series unit for processing.

Oxygen-saturated blood absorbs light differently than unsaturated blood. Thus the amount of visible and infrared light absorbed by blood flowing through a suitable peripheral area of the body, typically the finger in adults and the foot in neonates, can be used to calculate the ratio of oxygenated hemoglobin to total hemoglobin in arterial blood. The monitor displays this ratio as a percent (normal values typically range from 95% to 100% at sea level) alternating with SpCO and SpMet, and SpHb, SpOC, PVI and PI values if available on your unit.

**Note:** The monitor does not display SpCO values when you use a SpHb sensor and does not display SpHb values when you use a SpCO sensor.

The measurements rely on multiwavelength calibration equations to estimate the:

- Percentage of carboxyhemoglobin in arterial blood (SpCO).
- Percentage of methemoglobin in arterial blood (SpMet).
- Total hemoglobin concentration present in the blood (SpHb).
- Total oxygen content present in the blood (SpOC).
- Peripheral perfusion changes secondary to respiration (PVI).
- The arterial pulse strength as the percentage of pulsatile signal to non-pulsatile signal (PI).

The quality of measurements depends on the correct size and application of the sensor, adequate blood flow through the sensor site, and the sensor's exposure to ambient light. For correct placement and location of the sensors, refer to the *Directions for Use* contained with all Rainbow oximetry sensor packages.

---

## Warnings -- SpO<sub>2</sub> General

- As with all medical equipment, carefully route patient cabling to reduce the possibility of patient entanglement or strangulation.
- Do not place the pulse co-oximeter or accessories in any position that might cause it to fall on the patient.
- Do not start or operate the pulse co-oximeter unless the setup was verified to be correct.
- Do not use the pulse co-oximeter during magnetic resonance imaging (MRI) or in an MRI environment.
- Do not use the pulse co-oximeter if it appears or is suspected to be damaged.
- Explosion hazard: Do not use the pulse co-oximeter in the presence of flammable anesthetics or other flammable substance in combination with air, oxygen-enriched environments, or nitrous oxide.
- To ensure safety, avoid stacking multiple devices or placing anything on the instrument during operation.
- To protect against injury, follow the directions below:
  - Avoid placing the device on surfaces with visible liquid spills.
  - Do not soak or immerse the device in liquids.
  - Do not attempt to sterilize the device.
  - Use cleaning solutions only as instructed in this operator's manual.
  - Do not attempt to clean the device while monitoring patient.
- To protect from electric shock, always remove the sensor and completely disconnect the pulse co-oximeter before bathing the patient.
- If any measurement seems questionable, first check the patient's vital signs by alternate means and then check the pulse co-oximeter for proper functioning.
- Inaccurate respiration rate measurements may be caused by:
  - Improper sensor application
  - Low arterial perfusion
  - Motion artifact
  - Low arterial oxygen saturation
  - Excessive ambient or environmental noise
- Inaccurate SpCO and SpMet readings can be caused by:
  - Improper sensor application
  - Intravascular dyes such as indocyanine green or methylene blue
  - Abnormal hemoglobin levels
  - Low arterial perfusion
  - Low arterial oxygen saturation levels including altitude induced hypoxemia
  - Elevated total bilirubin levels
  - Motion artifact

- Inaccurate SpHb and SpOC readings may be caused by:
  - Improper sensor application
  - Intravascular dyes such as indocyanine green or methylene blue
  - Externally applied coloring and texture such as nail polish, acrylic nails, glitter, etc.
  - Elevated PaO<sub>2</sub> levels
  - Elevated levels of bilirubin
  - Low arterial perfusion
  - Motion artifact
  - Low arterial oxygen saturation levels
  - Elevated carboxyhemoglobin levels
  - Elevated methemoglobin levels
  - Hemoglobinopathies and synthesis disorders such as thalassemias, Hb s, Hb c, sickle cell, etcetera
  - Vasospastic disease such as Raynaud's
  - Elevated altitude
  - Peripheral vascular disease
  - Liver disease
  - EMI radiation interference
- Inaccurate SpO<sub>2</sub> readings may be caused by:
  - Improper sensor application.
  - Elevated levels of COHb or MetHb: High levels of COHb or MetHb may occur with a seemingly normal SpO<sub>2</sub>. When elevated levels of COHb or MetHb are suspected, laboratory analysis (co-Oximetry) of a blood sample should be performed.
  - Intravascular dyes, such as indocyanine green or methylene blue.
  - Externally applied coloring and texture, such as nail polish, acrylic nails, glitter, etc.
  - Elevated levels of bilirubin
  - Severe anemia
  - Low arterial perfusion
  - Motion artifact
- Interfering Substances: Dyes or any substance containing dyes that change usual blood pigmentation may cause erroneous readings.
- The pulse co-oximeter is intended only as an adjunct device in patient assessment. It should not be used as the sole basis for diagnosis or therapy decisions. It must be used in conjunction with clinical signs and symptoms.
- The pulse co-oximeter is not an apnea monitor.
- The pulse co-oximeter may be used during defibrillation, but this may affect the accuracy or availability of the parameters and measurements.
- The pulse co-oximeter may be used during electrocautery, but this may affect the accuracy or availability of the parameters and measurements.
- The pulse co-oximeter should not be used for arrhythmia analysis



- 
- To protect from electric shock, always remove the sensor and completely disconnect the pulse co-oximeter before bathing the patient.
  - SpCO readings may not be provided if there are low arterial saturation levels or elevated methemoglobin levels.
  - SpO<sub>2</sub>, SpCO, SpMet, and SpHb are empirically calibrated in healthy adult volunteers with normal levels of carboxyhemoglobin (COHb) and methemoglobin (MetHb).
  - Do not adjust, repair, open, disassemble, or modify the pulse co-oximeter or accessories. Injury to personnel or equipment damage could occur. Return the pulse co-oximeter for servicing if necessary.

## Cautions

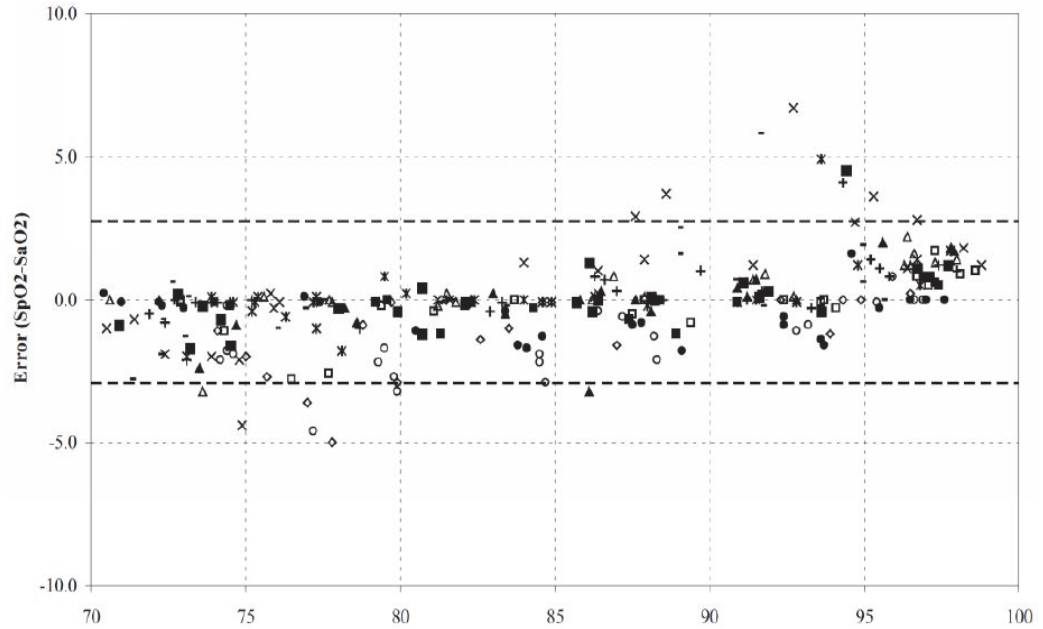
- Do not place the pulse co-oximeter where the controls can be changed by the patient.
- Electrical shock and flammability hazard: Before cleaning, always turn off the instrument and disconnect from any power source.
- When patients are undergoing photodynamic therapy they may be sensitive to light sources. Pulse oximetry may be used only under careful clinical supervision for short time periods to minimize interference with photodynamic therapy.
- Do not place the pulse co-oximeter on electrical equipment that may affect the instrument, preventing it from working properly.
- If SpO<sub>2</sub> values indicate hypoxemia, a laboratory blood sample should be taken to confirm the patient's condition.
- If the Low Perfusion message is frequently displayed, find a better perfused monitoring site. In the interim, assess the patient and, if indicated, verify oxygenation status through other means.
- If using pulse oximetry during full body irradiation, keep the sensor out of the radiation field. If the sensor is exposed to the radiation, the reading might be inaccurate or the instrument might read zero for the duration of the active irradiation period.
- The instrument must be configured to match your local power line frequency to allow for the cancellation of noise introduced by fluorescent lights and other sources.
- To ensure that alarm limits are appropriate for the patient being monitored, check the limits each time the pulse co-oximeter is used.
- Variation in hemoglobin measurements may be profound and may be affected by sampling technique as well as the patient's physiological conditions. Any results exhibiting inconsistency with the patient's clinical status should be repeated and/or supplemented with additional test data. Blood samples should be analyzed by laboratory instruments prior to clinical decision making to completely understand the patient's condition.
- Do not submerge the pulse co-oximeter in any cleaning solution or attempt to sterilize by autoclave, irradiation, steam, gas, ethylene oxide or any other method. This will seriously damage the pulse co-oximeter.

- Electrical Shock Hazard: Carry out periodic tests to verify that leakage currents of patient-applied circuits and the system are within acceptable limits as specified by the applicable safety standards. The summation of leakage currents must be checked and in compliance with IEC 60601-1 and UL60601-1. The system leakage current must be checked when connecting external equipment to the system. When an event such as a component drop of approximately 1 meter or greater or a spillage of blood or other liquids occurs, retest before further use. Injury to personnel could occur.
- Disposal of product - Comply with local laws in the disposal of the instrument and/or its accessories.
- To minimize radio interference, other electrical equipment that emits radio frequency transmissions should not be in close proximity to the pulse co-oximeter.

# SpO<sub>2</sub> Accuracy Specifications

Accuracy testing for SpO<sub>2</sub> was performed on healthy adult subjects. The tables below provides A<sub>RMS</sub> (Accuracy Root Mean Square) values measured using the Masimo Rainbow SET Technology.

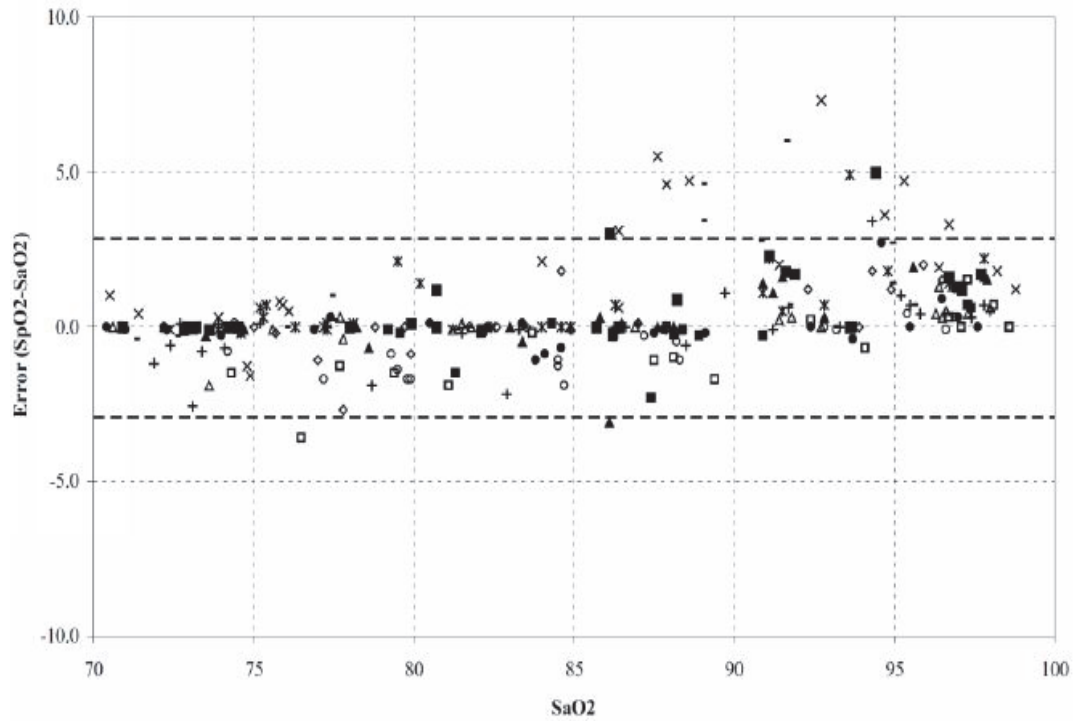
## Masimo M-LNCS Sensors, Adult and Pediatric



MEASURED A <sub>RMS</sub> VALUES	
Range	A <sub>RMS</sub>
90-100%	1.64%
80-90%	1.07%
70-80%	1.55%

Overall Claimed Accuracy Value	
Range	A <sub>RMS</sub>
70-100%	± 2%

**Masimo M-LNCS Sensors, Infant and Neonate**

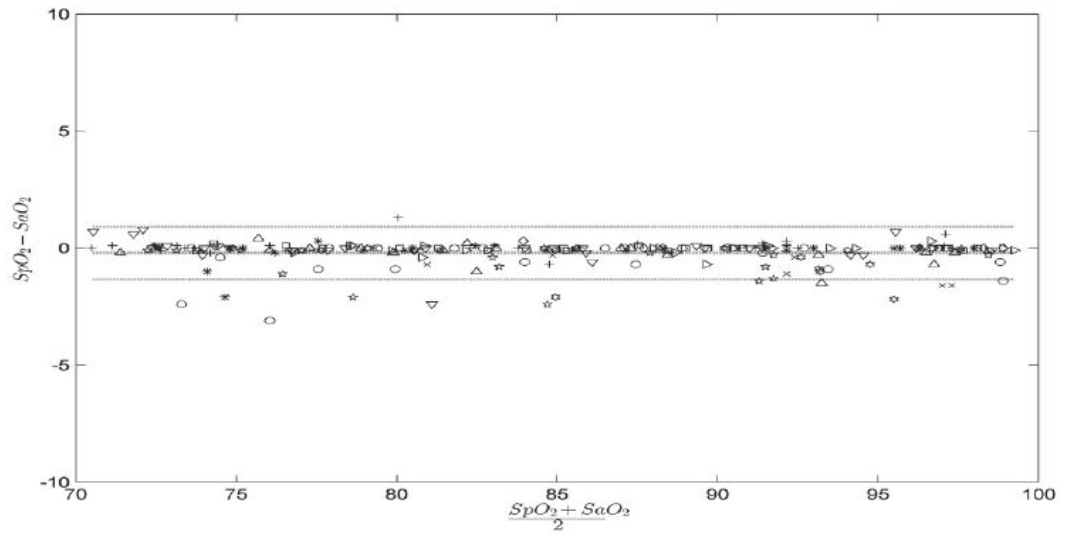


MEASURED $A_{RMS}$ VALUES	
Range	$A_{RMS}$
90-100%	1.85%
80-90%	1.44%
70-80%	0.89%

Overall Claimed Accuracy Value			
Range	$A_{RMS}$		
	Inf	Neo*	Neo Pt*
70-100%	± 2%	± 2% Adult ± 3% Neonatal	± 3%

\*The saturation accuracy of the Neonate and Preterm sensors were validated on adult volunteers and 1% was added to account for the properties of fetal hemoglobin.

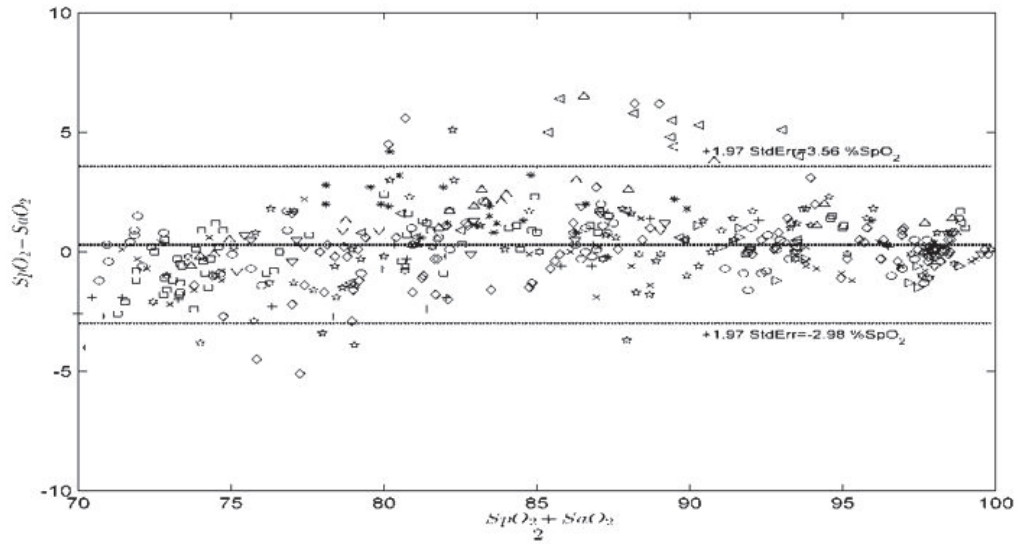
**Masimo Rainbow DCI/DCIP Sensors**



MEASURED $A_{RMS}$ VALUES	
Range	$A_{RMS}$
90-100%	0.60%
80-90%	0.54%
70-80%	0.67%

Overall Claimed Accuracy Value	
Range	$A_{RMS}$
70-100%	2%

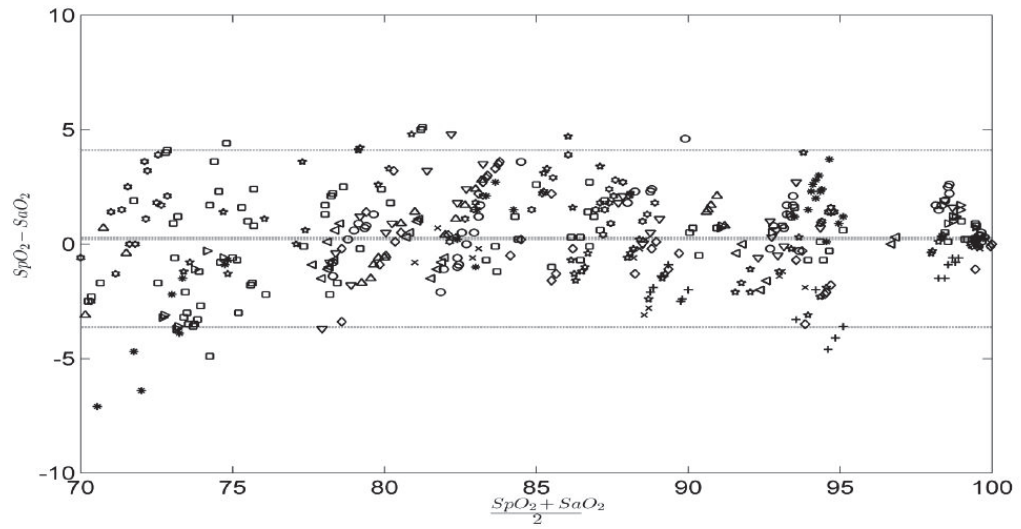
**Masimo Red DBI Sensors**



MEASURED A <sub>RMS</sub> VALUES	
Range	A <sub>RMS</sub>
90-100%	1.03%
80-90%	2.03%
70-80%	1.03%

Overall Claimed Accuracy Value	
Range	A <sub>RMS</sub>
70-100%	2%

**Massimo Rainbow R-Series Sensors**



MEASURED $A_{RMS}$ VALUES	
Range	$A_{RMS}$
90-100%	1.57%
80-90%	1.80%
70-80%	2.47%

Overall Claimed Accuracy Value	
Range	$A_{RMS}$
70-100%	$\pm 2\%$

## SpO<sub>2</sub> Setup and Use

To take accurate SpO<sub>2</sub> measurements using the X Series unit, you must perform the following steps, each of which corresponds to a section in this chapter.

1. Select the correct sensor.
2. Apply the sensor to the patient.
3. Connect the sensor to the X Series unit.
4. Configure alarms and settings (if the current alarms and settings are not appropriate).

Pulse oximetry measurements begin as soon as the sensor is applied to the patient and connected to the X Series unit.

### Selecting the SpO<sub>2</sub> Sensor

When selecting the sensor, consider the patient's weight, the adequacy of perfusion, the available sensor sites, and the anticipated duration of monitoring. For more information, refer to the *Accessories* section of this chapter, which provides a list of ZOLL-approved reusable and single-use sensors for adult, pediatric, and neonate patients. Before applying the sensor, always familiarize yourself with the *Directions for Use* that the manufacturer provides with the sensor.

**Note:** An SpHb sensor is required for measuring the optional SpHb and SpOC parameters. The monitor does not display SpCO values when you use a SpHb sensor and does not display SpHb values when you use a SpCO sensor.

### Applying the SpO<sub>2</sub> Sensor

Choose a site that is well perfused and restricts a conscious patient's movements the least. The ring finger or middle finger of the nondominant hand is preferred.

Alternatively, you can use the other digits on the nondominant hand. Be sure the sensor's detector is fully covered by flesh. You can use the great toe or long toe (next to the great toe) on restrained patients or patients whose hands are unavailable.

To prevent interference from ambient light, ensure that the sensor is properly applied, and cover the sensor site with opaque material, if required. Failure to take this precaution in high ambient light conditions may result in inaccurate measurements.

Do not select an SpO<sub>2</sub> sensor site on the same arm/leg as an NIBP cuff. Inflation of the cuff will cause the SpO<sub>2</sub> values to read incorrectly.



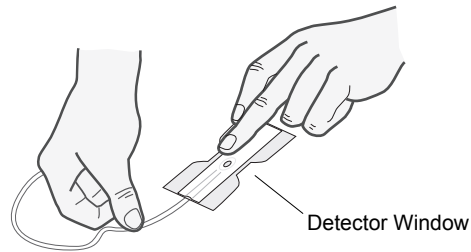
## Applying a Two-Piece Single-Use Sensor/Cable

When applying a single-use sensor, be careful not to wrap the adhesive too tightly as this can cause venous pulsations that could lead to inaccurate saturation measurements.

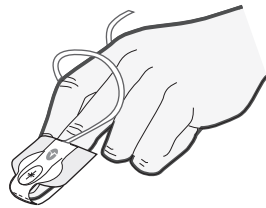
1. Remove plastic backing from the sensor and locate transparent windows on the adhesive side. The transparent windows cover the optical components.

**Note:** When selecting a sensor site, priority should be given to an extremity free of an arterial catheter, blood pressure cuff, or intravascular infusion line.

2. Orient the sensor so the dashed line in the middle of the sensor is centered on the tip of the digit. Wrap adhesive flaps on non-cable end around the digit.

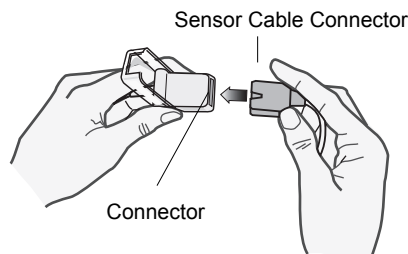


3. Fold cable end over top of digit so that windows are directly opposite each other. Wrap adhesive securely around sides of digit.



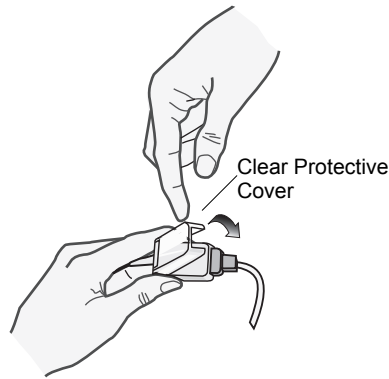
**Note:** If the sensor does not track the pulse reliably, it may be incorrectly positioned or the sensor site may be too thick, thin, or deeply pigmented, or otherwise deeply colored (for example, as a result of externally applied coloring such as nail polish, dye, or pigmented cream) to permit appropriate light transmission. If any of these situations occurs, reposition the sensor or choose an alternate sensor for use on a different site.

4. Lift the clear plastic protective cover from the female end of the extension cable, then plug the sensor cable's male connector into the extension cable connector -- make sure that the plug is all the way into the connector:



**Figure 10-1 Plug the Sensor Connectors Together**

5. Lower the clear plastic cover over the connection to secure it:



**Figure 10-2 Lower Plastic Cover Over Cable Connection**

6. See “Connecting the SpO<sub>2</sub> Sensor” on page 10-15 to connect the cable to the unit.

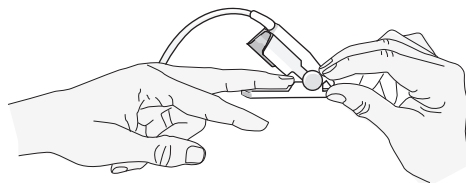
## Applying a Reusable Sensor/Cable

The following instructions describe how to apply a reusable Rainbow sensor. For correct placement and location of the sensors, refer to the *Directions for Use* contained with all Rainbow oximetry sensor packages.

For all other reusable sensors, refer to the sensor packaging and the manufacturer’s *Directions for Use* for instructions on how to apply the sensor.

After selecting a monitoring site, apply the reusable sensor as follows:

1. Place the selected digit over the sensor window, making sure that the sensor cable runs over the top of the patient’s hand.
2. On finger sites, make sure the tip of the finger touches the raised digit stop inside the sensor. If the fingernail is long, it may extend over and past the finger stop.



3. Check the sensor position to ensure that the top and bottom halves of the sensor are parallel. To ensure accurate data, you must have complete coverage of the detector window.



**Note:** With smaller digits, the digit may not need to be pushed all the way to the stop to completely cover the detector window.

4. Based on the type of patient cable you are using, do one of the following:
  - If you are using a direct one-piece patient cable, see “Connecting the SpO<sub>2</sub> Sensor” on page 10-15.
  - If you are using the two-piece patient cable, lift the clear plastic protective cover from the female end of the extension cable, then plug the sensor cable’s male connector into the extension cable connector -- make sure that the plug is all the way into the connector (see Figure 10-1).
5. Lower the clear plastic cover over the connection to secure it (see Figure 10-2).
6. See “Connecting the SpO<sub>2</sub> Sensor” on page 10-15 to connect the cable to the unit.

## Cleaning and Reuse of Sensors

Reusable sensors can be cleaned as follows:

Disconnect the sensor from the patient cable, if appropriate. Wipe the entire sensor clean with a 70% isopropyl alcohol moistened pad. Allow the sensor to air dry before returning it to use.

## Connecting the SpO<sub>2</sub> Sensor

To connect the sensor to the X Series unit:

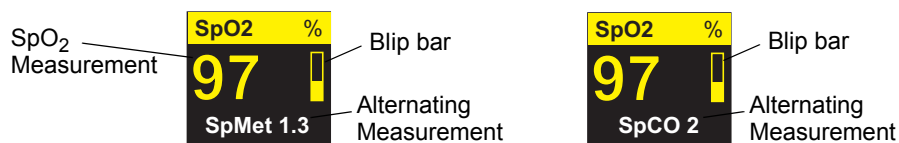
1. When using a sensor extension cable, inspect the cable before use. Replace the cable if it shows any signs of wear, breakage, or fraying. Plug the sensor extension cable into the SpO<sub>2</sub> receptacle on the side of the X Series unit:



**Figure 10-3 Connecting the SpO<sub>2</sub> Sensor to the X Series Unit**

## Displaying Measurements

When the connection is made between the sensor and the unit, the message, *INITIALIZING*, appears in the display. After a brief delay, the unit displays the measurement. If SpCO and SpMet, or SpHb, SpOC, PVI and PI are installed and monitoring is on for these parameters, the measurements will alternate every two seconds underneath the display.




**Note:** SpHb and SpOC measurements require an SpHb sensor. The monitor does not display SpCO values when you use a SpHb sensor and does not display SpHb values when you use a SpCO sensor.

If the message, *SENSOR FAILURE*, appears, the sensor is either incompatible with the X Series unit, or it is not working, and you will need to replace the sensor.




A blip bar appears on the right side of the SpO<sub>2</sub> numeric display window. The blip bar indicates the pulse derived from the plethysmograph normalized waveform.

## Enabling/Disabling SpO<sub>2</sub> Alarms and Setting Alarm Limits

When enabled, the X Series unit sounds alarms whenever measurements are outside set limits for the high and low SpO<sub>2</sub> values (and, if installed and monitoring is on, SpCO and SpMet, and SpHb, SpOC, PVI and PI values).

You can enable (or disable) alarms and set Upper and Lower alarm limits through the Alarms quick access key () or through the SpO<sub>2</sub> Parameter Control Panel.

To configure alarms through the Alarms quick access key:

1. Press the **More** quick access key (.
2. Press .
3. Press the **Limits** quick access key (.
4. Use the navigation buttons to highlight and select the appropriate alarm menu selection (SpCO, SpMet, SpHb, SpOC, PVI, PI).
5. On the selected Alarm Settings menu, use the navigation keys to select the fields that you want to change. The fields are
  - Upper Limit Enable
  - Lower Limit Enable
  - Upper Limit
  - Lower Limit
6. When you are finished changing values on the alarm menu, navigate to the Backarrow key to exit the menu.

**Note:** If you set the SpO<sub>2</sub> low alarm limit below the low limit default (85%), the X Series issues an equipment alert.

## Setting Upper and Lower SpO<sub>2</sub> Alarm Limits

Initially, the SpO<sub>2</sub> Alarm Settings menu specifies whether the SpO<sub>2</sub> alarms are enabled (**ON**) or disabled (**OFF**), and displays the default upper and lower SpO<sub>2</sub> limits. The upper and lower limits can be **ON** or **OFF** (default is **OFF**). The following table lists the default SpO<sub>2</sub> limits for adult, pediatric, and neonate patients, and gives the range in which you can set these limits.

Patient Type	SpO <sub>2</sub> Limit Default	SpO <sub>2</sub> Limit Range
Adult	Lower: 85% Upper: 100%	Lower: 50 - 98% Upper: 52 - 100%
Pediatric	Lower: 85% Upper: 100%	Lower: 50 - 98% Upper: 52 - 100%
Neonate	Lower: 85% Upper: 95%	Lower: 50 - 98% Upper: 52 - 100%

## Setting Upper and Lower SpCO and SpMet Alarm Limits

The following table lists the default SpCO and SpMet limits for adult, pediatric, and neonate patients, and gives the range in which you can set these limits.

Patient Type	SpCO Limit Default	SpCO Limit Range	SpMet Limit Default	SpMet Limit Range
Adult	Lower: 0% Upper: 10%	Lower: 0 - 98% Upper: 2 - 100%	Lower: 0% Upper: 3%	Lower: 0 - 98% Upper: 2 - 100%
Pediatric	Lower: 0% Upper: 10%	Lower: 0 - 98% Upper: 2 - 100%	Lower: 0% Upper: 3%	Lower: 0 - 98% Upper: 2 - 100%
Neonate	Lower: 0% Upper: 10%	Lower: 0 - 98% Upper: 2 - 100%	Lower: 0% Upper: 3%	Lower: 0 - 98% Upper: 2 - 100%

## Setting Upper and Lower SpHb Alarm Limits

The following table lists the default SpHb limits for adult, pediatric, and neonate patients, and gives the range in which you can set these limits

Patient Type	SpHb Limit Default	SpHb Limit Range
Adult	Lower: 7.0 g/dL 4.0 mmol/L Upper: 17.0 g/dL 11.0 mmol/L	Lower: 0 - 24.9 g/dL 0 - 15.4 mmol/L Upper: 2 - 25 g/dL 2 - 15.5 mmol/L
Pediatric	Lower: 7.0 g/dL 4.0 mmol/L Upper: 17.0 g/dL 11.0 mmol/L	Lower: 0 - 24.9 g/dL 0 - 15.4 mmol/L Upper: 2 - 25 g/dL 2 - 15.5 mmol/L
Neonate	Lower: 7.0g/dL 4.0 mmol/L Upper: 17.0 g/dL 11.0 mmol/L	Lower: 0 - 24.9 g/dL 0 - 15.4 mmol/L Upper: 2 - 25 g/dL 2 - 15.5 mmol/L

## Setting Upper and Lower SpOC Alarm Limits

The following table lists the default SpOC limits for adult, pediatric, and neonate patients, and gives the range in which you can set these limits

Patient Type	SpOC Limit Default	SpOC Limit Range
Adult	Lower: 10 ml/dL Upper: 25 ml/dL	Lower: 0 - 34.9 ml/dL Upper: 0.2 - 35 ml/dL
Pediatric	Lower: 10 ml/dL Upper: 25 ml/dL	Lower: 0 - 34.9 ml/dL Upper: 0.2 - 35 ml/dL
Neonate	Lower: 10 ml/dL Upper: 25 ml/dL	Lower: 0 - 34.9 ml/dL Upper: 0.2 - 35 ml/dL

## Setting Upper and Lower PVI Alarm Limits

The following table lists the default PVI limits for adult, pediatric, and neonate patients, and gives the range in which you can set these limits

<b>Patient Type</b>	<b>PVI Limit Default</b>	<b>PVI Limit Range</b>
Adult	Lower: 5% Upper: 40%	Lower: 0 - 98% Upper: 2 - 100%
Pediatric	Lower: 5% Upper: 40%	Lower: 0 - 98% Upper: 2 - 100%
Neonate	Lower: 5% Upper: 40%	Lower: 0 - 98% Upper: 2 - 100%

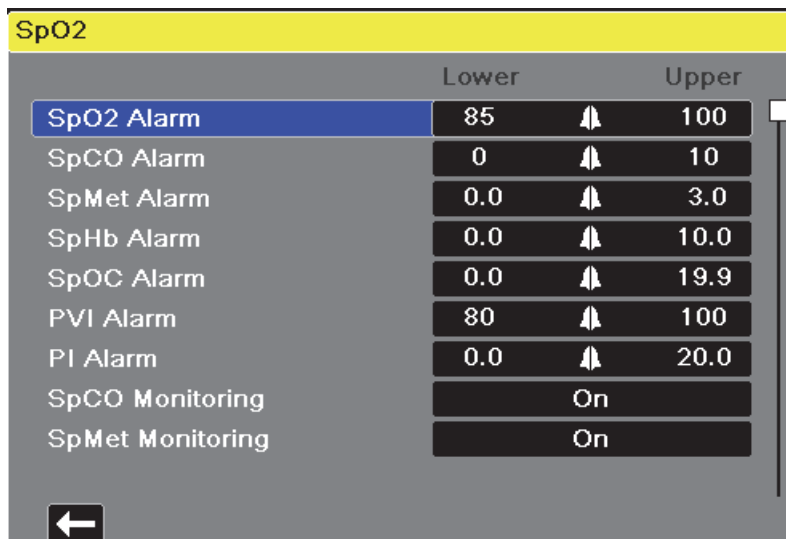
## Setting Upper and Lower PI Alarm Limits

The following table lists the default PI limits for adult, pediatric, and neonate patients, and gives the range in which you can set these limits

<b>Patient Type</b>	<b>PI Limit Default</b>	<b>PI Limit Range</b>
Adult	Lower: 0% Upper: 20%	Lower: 0 - 19.8% Upper: 0.2 - 20%
Pediatric	Lower: 0% Upper: 20%	Lower: 0 - 19.8% Upper: 0.2 - 20%
Neonate	Lower: 0% Upper: 20%	Lower: 0 - 19.8% Upper: 0.2 - 20%

## Using the SpO<sub>2</sub> Parameter Control Panel

Use the navigation keys to highlight and select the SpO<sub>2</sub> numeric display to display the SpO<sub>2</sub> Parameter Control Panel, where you can select options that optimize the use of SpO<sub>2</sub> for the patient:



### SpCO and SpMet, and SpHb, SpOC, PVI and PI Monitoring

If the SpCO and SpMet or the SpHb, SpOC, PVI and PI options are installed on your unit you can enable or disable monitoring these parameters on the SpO<sub>2</sub> Control Panel.

### Specifying the SpO<sub>2</sub> Averaging Time

The Masimo SpO<sub>2</sub> module in the X Series unit provides three different time periods over which SpO<sub>2</sub> values are averaged: 4 seconds, 8 seconds (default) and 16 seconds. The averaging period is rarely changed from the 8 second default setting. For high risk patients with rapidly changing SpO<sub>2</sub> conditions, use the 4 second setting. Use the 16 second setting only when the 8 second setting (default) is inadequate due to extremely high artifact conditions.

### Selecting the SpO<sub>2</sub> Sensitivity

You can select either normal or high sensitivity for SpO<sub>2</sub> monitoring. The Normal sensitivity setting is recommended setting for most patients. The High sensitivity setting allows you to monitor SpO<sub>2</sub> even under very low perfusion conditions. Such conditions may include severe hypotension or shock. With the High sensitivity setting, however, SpO<sub>2</sub> results are more easily contaminated by artifact. To ensure accurate SpO<sub>2</sub> readings when using the High sensitivity setting, observe the patient carefully and continuously.



## Selecting SpHb Venous Mode

If the SpHb option is installed, the X Series unit allows you to specify whether to use venous mode (**On**) as the blood sample source or not (**Off**). When **Off** (default) the X Series uses arterial as the blood sample source.

## Specifying the SpHb Averaging Time

If the SpHb option is installed, the X Series unit allows you to choose the time period over which SpHb values will be calculated: **Short**, **Medium**, and **Long** (default). Averaging time represents the approximate time period the X Series will use to calculate SpHb values. Longer averaging times allow you to see subtle changes in the SpHb value and tend to improve accuracy.

## Selecting the Heart Rate/ Pulse Rate (HR/PR) Tone

The unit allows you enable or disable the tone that the monitor uses to indicate detection of the patient's pulse: **On** or **Off** (no tone sounds). The default tone is **Off**.

## SpO2 System Messages

The X Series unit may display the following system messages when monitoring SpO<sub>2</sub>:

System Message	Cause
INITIALIZING	The SpO <sub>2</sub> pulse oximeter is initializing.
SEARCHING	The unit is searching for a pulse.
CHECK SENSOR	The SpO <sub>2</sub> sensor has become disconnected from the unit, or the sensor is no longer on the patient. Check sensor and then reconnect it to the unit or reapply it to the patient.
SENSOR FAILURE	The SpO <sub>2</sub> sensor is defective. Replace the sensor.
CABLE FAILURE	The SpO <sub>2</sub> cable is defective. Replace the cable.
LIFE EXPIRING	Adhesive/Sensor/Cable Failure. The adhesive/sensor/cable is nearing expiration. Replace the adhesive/sensor/cable.
LOW PERFUSION	Signal too small, move to better perfused site.
<i>SPO2 DISABLED</i>	A system error has occurred. The X Series unit cannot take SpO <sub>2</sub> measurements and should be serviced.
<i>TIME LEFT: XX:X HRS</i>	For sensors that support expiration, indicates the approximate time left before sensor expiration.

## Functional Testers and Patient Simulators

Some models of commercially available bench top functional testers and patient simulators can be used to verify the proper functionality of Masimo pulse oximeter sensors, cables and monitors. See the individual testing device's operator's manual for the procedures specific to the model of tester that you are using.

While such devices may be useful for verifying that the pulse oximeter sensor, cable, and monitor are functional, they are incapable of providing the data required to properly evaluate the accuracy of a system's SpO<sub>2</sub> measurements.

Fully evaluating the accuracy of the SpO<sub>2</sub> measurements requires, at a minimum, accommodating the wavelength characteristics of the sensor and reproducing the complex optical interaction of the sensor and the patient's tissue. These capabilities are beyond the scope of known bench top testers, including known devices which claim to measure sensor LED wavelength.

SpO<sub>2</sub> measurement accuracy can only be evaluated in vivo by comparing pulse oximeter readings with values traceable to SpO<sub>2</sub> measurements obtained from simultaneously sampled arterial blood using a laboratory CO-oximeter.

Many functional testers and patient simulators have been designed to interface with the pulse oximeter's expected calibration curves and may be suitable for use with Masimo monitors and/or sensors. Not all such devices, however, are adapted for use with the Masimo digital calibration system. While this will not affect use of the simulator for verifying system functionality, displayed SpO<sub>2</sub> measurement values may differ from the setting of the test device.

For a properly functioning monitor, this difference will be reproducible over time and from monitor to monitor within the performance specifications of the test device.

## Patents

All patent information related to the SpO<sub>2</sub> component of the X Series unit can be found at the following:

[www.masimo.com/patents.htm](http://www.masimo.com/patents.htm)

### **NO IMPLIED LICENSE**

Possession or purchase of this device does not convey any express or implied license to use the device with unauthorized sensors or cables which would, alone or in combination with this device, fall within the scope of one or more of the patents relating to this device.

# Chapter 11

## Monitoring Invasive Pressures (IBP)

---

The X Series IBP inputs are Type CF defibrillator proof.

This chapter describes how to use the X Series unit to monitor invasive pressures (IBP).

The X Series unit has three invasive pressure channels: P1, P2, and P3. You can use these channels to measure arterial, venous, or intracranial pressures using invasive transducers with 5uV/V/mmHg sensitivity. Each channel requires its own connector, cabling, and pressure transducer.

### Invasive Pressure Transducers

The X Series unit is compatible with many types of invasive pressure transducers, including non disposable, disposable dome, and fully disposable transducers. See Appendix B, *Accessories*, for a list of compatible transducers. Do not use light-sensitive disposable transducers.

Use the invasive pressure transducers according to your organization's established clinical protocol and follow the manufacturer's recommendations. Always refer the manufacturer's *Directions for Use* before using a transducer.

- Warning!**
- **If electrocautery is used, always avoid using any transducer with a conductive (metal) case connected to its ground shield. Using a conductive transducer case that is connected to its cable shield risks high-frequency burns at the ECG electrodes if the transducer case becomes grounded to earth.**
  - **Normal alarm functions will detect complete disconnections of invasive pressure transducers; however, the alarm functions will not detect a partial disconnection or the use of some incompatible transducers. Use only approved transducers and ensure that the transducers are connected properly.**
  - **Before you use the X Series unit on a new patient, always turn it off for at least 2 minutes. This clears the previous patient's trend values, alarm limit settings, and NIBP cuff inflation pressure.**
  - **Use *only* ZOLL-approved IBP sensors. Use of non-approved sensors may result in inaccurate IBP measurements.**
- 

## IBP Setup

To take safe and accurate IBP measurements using the X Series, you must perform the following steps, each of which corresponds to a section in this chapter. Read each section carefully before you perform IBP measurements.

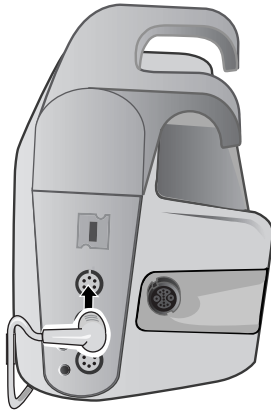
1. Attach the invasive pressure transducer to the X Series unit.
2. Zero the transducer.
3. Set the invasive pressure alarms (according to your organization's standards).
4. Select a label for the invasive pressure channel.

---

## Attaching the Invasive Pressure Transducer

Follow these steps when attaching the invasive pressure transducer:

1. Inspect the transducer cable. If the cable shows any signs of wear, breakage, or fraying, replace the cable. Replace the transducer dome, if necessary.
2. Apply the transducer according to your organization's procedures. Always refer the manufacturer's Directions for Use before using a transducer.
3. If the transducer is a disposable unit with a separate cable, connect the transducer to the transducer cable.
4. Plug the transducer cable into one of the three six-pin IBP cable connectors on the side of the X Series unit.



**Figure 11-1 Plugging the Transducer into the X Series**

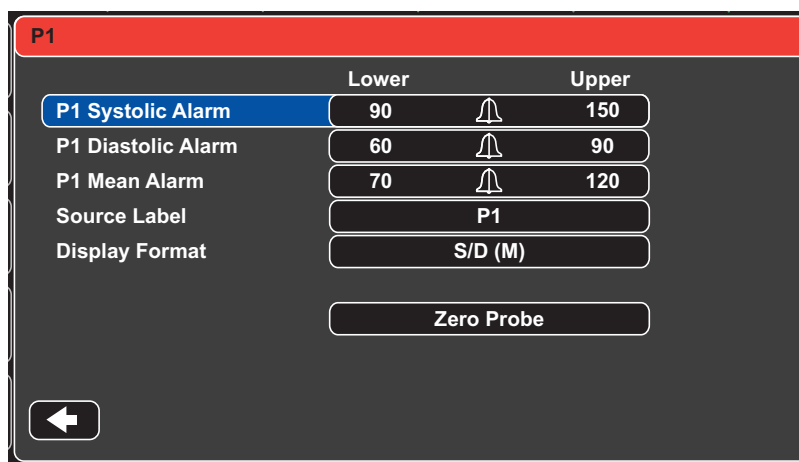
When you plug the transducer cable into the unit, the message *ZERO PROBE* appears in the numeric display window for that IBP channel.

## Zeroing the Transducer

To ensure that the X Series unit measures pressure accurately, you must zero the transducer before each use. If you change or disconnect a transducer, you must zero the new transducer before use. If you move a transducer to a different monitor, you must zero the transducer again, even if you have already done so on another unit. In addition to the procedure below, follow the transducer manufacturer's *Directions for Use* and your organization's established clinical protocol.

Follow these steps when zeroing a transducer:

1. Place the transducer at the same height as the patient's left atrium.
2. Close the transducer stopcock to the patient.
3. Open the transducer's venting stopcock to atmospheric air.
4. Allow the transducer a few seconds to settle.
5. Use the navigation keys to highlight and select the transducer's IBP channel and display the IBP channel's parameter control panel:



**Figure 11-2 IBP Channel Parameter Control Panel**

6. Select **Zero Probe**. The unit displays the message *ZEROING* in the IBP Channel's numeric display.
7. The message *ZEROED* appears in the IBP channel's numeric display.
8. Close the transducer's stopcock.
9. If the unit was unable to zero the transducer, the message *ZERO REJECTED* appears in the IBP channel's numeric display. The unit will not display pressure values for the IBP channel until it has successfully zeroed the transducer and established an acceptable zero reference.

Check that the unit is open to atmospheric air and that it is properly connected to the unit, then try zeroing the transducer again. The X Series unit will not zero the transducer if it detects pulsation in the pressure channel, if there is too much noise in the signal, or if transducer's offset is too great.

If you cannot zero the transducer after several attempts, replace the transducer or the transducer cable.

## Rezeroing a Transducer

You can re-zero a transducer at any time by opening the transducer stopcock to atmospheric air.

If the unit accepts the new zero reference value, the unit displays pressure values that are based on that value and adjusts the waveform according to the new scale.

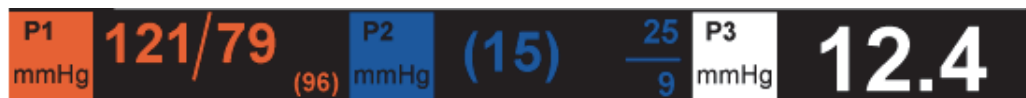
---

**Warning!** If you attempt to zero an IBP channel after the channel has been successfully zeroed and is currently monitoring a pressure waveform, the unit will display the message, **ZERO REJECTED**, in the IBP channel's numeric window. This message will preempt the display of the valid invasive pressure numerics.

---

## Displaying IBP Measurements

After attaching and zeroing a transducer, the X Series unit displays the invasive pressure's systolic, diastolic, and MEAN values in the IBP channel's numeric display and, optionally (if enabled through the unit's Waveform Select menu) the waveform for that IBP channel:



The X Series unit allows you to specify a label that identifies the channel's IBP measurement, and to select a display format for the numeric display.

The unit displays the waveform scales after you zero the transducer. When the unit accepts the zero reference value, it determines the waveform scales and displays them.

## Conditions Affecting IBP Measurements

When reading blood pressure measurements on the IBP numeric display, keep in mind that the following conditions can affect the accuracy of IBP measurements:

- Catheter placement in the vasculature. Artifact such as catheter whip should be handled per your established clinical protocols.
- Position of the transducer stopcock, catheter, and flush port.
- Saline line flushes which will temporarily interrupt accurate pressure measurement.
- Position of the transducer relative to the patient's phlebostatic axis or catheter tip.
- Patient movement.
- Catheter clogging.
- Air bubbles in catheter or transducer dome.
- Electromagnetic interference.

---

**Caution** Flush catheter regularly while taking IBP measurements. Always view the IBP waveform to ensure that pressure measurements are based on a physiological waveform.

---




## Enabling/Disabling IBP Alarms and Setting Alarm Limits

When enabled, the X Series unit sounds alarms whenever IBP measurements are outside set limits for the following:

- High and Low Systolic Pressure
- High and Low Diastolic Pressure
- High and Low Mean Arterial Pressure (MEAN)

**Note:** When enabled, any of the low alarms for IBP (systolic, diastolic, or mean) will also provide an alert in the event of a disconnected catheter.

To enable (or disable) IBP alarms and set Upper and Lower alarm limits and IBP channel, you can either use the navigation buttons to highlight and select the IBP channel display or:

1. Press the More quick access key ()
2. Press .
3. Press the **Limits** quick access key ()
4. Use the navigation buttons to highlight and select the appropriate alarm menu selection. For each IBP channel, there are alarm menus for systolic (Systolic Alarm), diastolic (Diastolic Alarm) and mean arterial pressure (Mean Alarm) alarm settings. On the selected Alarm Settings menu, use the navigation keys to select the fields that you want to change. The fields are

- **Upper Limit Enable**
- **Lower Limit Enable**
- **Upper Limit**
- **Lower Limit**



5. When you are finished changing values on the alarm menu, navigate to the Backarrow key to exit the menu.

### Setting Upper and Lower Systolic (SYS) Alarm Limits

Initially, the IBP Systolic Alarm Settings menu specifies that the IBP systolic pressure alarms are enabled (**ON**) or disabled (**OFF**), and displays the default upper and lower systolic limits. The upper and lower limits can be **ON** or **OFF** (default is **OFF**). The following table lists the default IBP Systolic limits for adult, pediatric, and neonate patients, and gives the range in which you can set these limits:

Patient Type	IBP Systolic Limit Default	IBP Systolic Limit Range
Adult	Lower: 75 mmHg Upper: 220 mmHg	Lower: -30 to 298 mmHg Upper: -28 to 300 mmHg
Pediatric	Lower: 75 mmHg Upper: 145 mmHg	Lower: -30 to 298 mmHg Upper: -28 to 300 mmHg
Neonate	Lower: 50 mmHg Upper: 100 mmHg	Lower: -30 to 298 mmHg Upper: -28 to 300 mmHg



## Setting Upper and Lower Diastolic (DIA) Alarm Limits

Initially, the IBP Diastolic Alarm Settings menu specifies that the IBP diastolic pressure alarms are enabled (**ON**) or disabled (**OFF**), and displays the default Upper and Lower diastolic limits. The upper and lower limits can be **ON** or **OFF** (default is **OFF**). The following table lists the default diastolic limits for adult, pediatric, and neonate patients, and gives the range in which you can set these limits:

Patient Type	IBP Diastolic Limit Default	IBP Diastolic Limit Range
Adult	Lower: 35 mmHg Upper: 110 mmHg	Lower: -30 to 298 mmHg Upper: -28 to 300 mmHg
Pediatric	Lower: 35 mmHg Upper: 100 mmHg	Lower: -30 to 298 mmHg Upper: -28 to 300 mmHg
Neonate	Lower: 30 mmHg Upper: 70 mmHg	Lower: -30 to 298 mmHg Upper: -28 to 300 mmHg

## Setting Upper and Lower Mean Arterial Pressure (MEAN) Alarm Limits

Initially, the IBP MEAN Alarm Settings menu specifies that IBP MEAN alarms are enabled (**ON**) or disabled (**OFF**), and displays the default Upper and Lower MEAN limits. The upper and lower limits can be **ON** or **OFF** (default is **OFF**). The following table lists the default MEAN alarm limits for adult, pediatric, and neonate patients, and gives the range in which you can set these limits:

Patient Type	IBP Mean Limit Default	IBP Mean Limit Range
Adult	Lower: 50 mmHg Upper: 120 mmHg	Lower: -30 to 298 mmHg Upper: -28 to 300 mmHg
Pediatric	Lower: 50 mmHg Upper: 110 mmHg	Lower: -30 to 298 mmHg Upper: -28 to 300 mmHg
Neonate	Lower: 35 mmHg Upper: 80 mmHg	Lower: -30 to 298 mmHg Upper: -28 to 300 mmHg

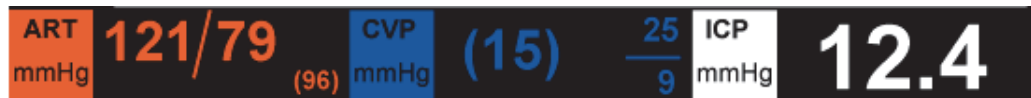
## Setting IBP Source Label

In the IBP channel menu, you can select a label that identifies the source of the channel's IBP measurement. By default, the channels are labeled P1, P2, and P3.

At the Source Label prompt, you can specify that the unit display one of the following labels to identify the IBP channel:

Source Label	Description	Source Label	Description
<b>ABP</b>	Abdominal Aorta Pressure	<b>AO</b>	Aorta
<b>ART</b>	Arterial Pressure	<b>BAP</b>	Brachial Artery Pressure
<b>CVP</b>	Central Venous Pressure	<b>FAP</b>	Femoral Artery Pressure
<b>ICP</b>	Intracranial Pressure	<b>LAP</b>	Labial Artery Pressure
<b>PAP</b>	Pulmonary Artery Pressure	<b>RAP</b>	Radial Artery Pressure
<b>UAP</b>	Umbilical Artery Pressure	<b>UVP</b>	Umbilical Venous Pressure

In the following example, source labels are specified for all three IBP channels:



---

## IBP System Messages

The X Series unit may display the following messages when monitoring IBP:

<b>System Message</b>	<b>Cause</b>
<i>TRANSDUCER FAILURE</i>	The IBP probe is damaged and needs to be replaced.
<i>INCOMPATIBLE TRANSDUCER</i>	The IBP probe is not compatible. See the Appendix B, <i>Accessories</i> , for a list of ZOLL-approved IBP probes.
<i>CHECK PROBE</i>	The IBP probed has become disconnected.
<i>ZERO PROBE</i>	The IBP probe is connected and needs to be zeroed.
<i>ZEROING</i>	The IBP probe is zeroing.
<i>IBP DISABLED</i>	A system error has occurred, and the X Series unit should be serviced.
<i>ZERO REJECTED</i>	The IBP probe was not removed due to a pulsatile pressure signal, excessive IBP artifact or excessive transducer offset.



# Chapter 12

## Monitoring Temperature

---

The X Series Temperature inputs are Type CF defibrillator proof.

This chapter describes how to use the X Series unit to monitor temperature.

The X Series unit provides two temperature channels. When both channels are in use, the unit displays each channel's temperature successively, followed by the difference between the temperatures (labeled  $\Delta T$ ).

### Temperature Monitoring Setup

To monitor temperature using the X Series unit, perform the following steps:

1. Select the temperature probe and apply it to the patient.
2. Connect the temperature probe to the X Series unit.
3. Configure Temperature alarms and settings (if the current Temperature alarms and settings are not appropriate).

## Selecting and Applying Temperature Probes

You should use only temperature probes that are approved for use with the X Series unit. See Appendix B, *Accessories* for a list of ZOLL-approved temperature probes. The use of other probes that do not match the performance specifications of the ZOLL-approved probes may produce incorrect temperature readings.

To apply the temperature probe to the patient, follow your organization's standard procedures. Always refer to probe manufacturer's Directions for Use before using the probe.

- 
- Warning!**
- **The application and use of metal-jacketed temperature probes that come in contact with conductive objects or clinical personnel during electrocautery may cause burns at the point of contact between the patient and the temperature probe.**
  - **To ensure safe and reliable operation including biocompatibility, use only ZOLL-approved temperature probes.**
- 

## Connecting the Temperature Probe

To connect the temperature probe, insert the probe's 1/4" plug into one of the two connection jacks on the side of the X Series unit.



**Figure 12-1 Connecting the Temperature Probe to the X Series Unit**

## Displaying Temperature





When you connect the probe, the unit displays the temperature after a brief pause. The X Series unit displays temperature as a numeric value in the Temperature window. You can specify that the unit display the temperature in °C or °F.

# Enabling/Disabling Temperature Alarms and Setting Alarm Limits

When enabled, the X Series unit sounds alarms whenever temperature measurements are outside set limits.

You can enable (or disable) temperature alarms and set the upper and lower alarm limits through the Alarms quick access key or the Temp Parameter Control Panel.

To configure temperature alarms through the **Alarms** quick access key:

1. Press the More quick access key ()
2. Press .
3. Press the **Limits** quick access key ()
4. Use the navigation keys to highlight and select the **T1 Alarm, T2 Alarm, or ΔT Alarm** menu selection. On the Alarm Settings menu, use the navigation keys to select the fields that you want to change. The fields are
  - **Upper Limit Enable**
  - **Lower Limit Enable**
  - **Upper Limit**
  - **Lower Limit**
5. When you are finished changing values on the alarm menu, navigate to the Backarrow key  to exit the menu.

## Setting Upper and Lower Temperature Alarm Limits

Initially, the Temperature Alarm Settings menu specifies that the Temperature alarms are enabled or disabled and displays the default upper and lower limits. The upper and lower limits can be **ON** or **OFF** (default is **OFF**). The following table lists the default Temperature limits for adult, pediatric, and neonate patients, and gives the range in which you can set these limits:

Patient Type	Temperature Limit Default	Temperature Limit Range
Adult	Lower: 35 ° C (95.0 ° F) Upper: 37.8 ° C (100 ° F)	Lower: 0.0 - 48.0 ° C (32.0 - 120.0 ° F) Upper: 2.0 - 50.0 ° C (34.0 - 122.0 ° F)
Pediatric	Lower: 35 ° C (95.0 ° F) Upper: 37.8 ° C (100 ° F)	Lower: 0.0 - 48.0 ° C (32.0 - 120.0 ° F) Upper: 2.0 - 50.0 ° C (34.0 - 122.0 ° F)
Neonate	Lower: 35 ° C (95.0 ° F) Upper: 37.8 ° C (100 ° F)	Lower: 0.0 - 48.0 ° C (32.0 - 120.0 ° F) Upper: 2.0 - 50.0 ° C (34.0 - 122.0 ° F)

## Setting Upper and Lower Temperature Alarm Limits

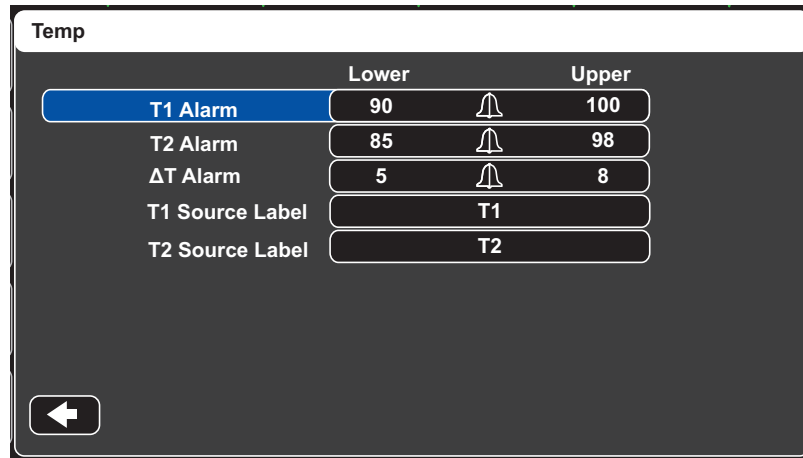
Initially, the  $\Delta$  Temperature Alarm Settings menu specifies that the  $\Delta$  Temperature alarms are enabled (**ON**), and displays the default upper and lower limits. The upper and lower limits can be **ON** or **OFF** (default is **OFF**). The following table lists the default  $\Delta$  Temperature limits for adult, pediatric, and neonate patients, and gives the range in which you can set these limits:

Patient Type	$\Delta$ Temperature Limit Default	$\Delta$ Temperature Limit Range
Adult	Lower: 0.0° F (0.0° C) Upper: 5.0° F (-15° C)	Lower: 0.0 - 89.8° F (0.0 - 32.1° C) Upper: 0.2 - 90.0° F (-17.7 - 32.2° C)
Pediatric	Lower: 0.0° F (0.0° C) Upper: 5.0° F (-15° C)	Lower: 0.0 - 89.8° F (0.0 - 32.1° C) Upper: 0.2 - 90.0° F (-17.7 - 32.2° C)
Neonate	Lower: 0.0° F (0.0° C) Upper: 5.0° F (-15° C)	Lower: 0.0 - 89.8° F (0.0 - 32.1° C) Upper: 0.2 - 90.0° F (-17.7 - 32.2° C)



## Selecting the Temperature Label

Through the Temp Parameter Control Panel, you can configure alarms (as described previously) and select descriptive Temperature channel labels that will appear on the numeric display and on the trend report:



**Figure 12-2 Temp Parameter Control Panel**

You can select one of the following labels for each temperature channel:

Source Label	Description
<b>ART</b>	Arterial temperature probe
<b>CORE</b>	Central body temperature or tympanic membrane temperature probe
<b>ESOPH</b>	Esophageal temperature probe
<b>RECT</b>	Rectal temperature probe
<b>SKIN</b>	Skin temperature probe (surface application)
<b>VEN</b>	Ventilator airway temperature probe
<b>NASO</b>	Nasopharynx or nasal/oral temperature probe

If you don't select a label, the Temperature channels appear with the default labels of T1 and T2.

## Temperature System Messages

The X Series unit may display the following messages when monitoring Temperature.

**Note:** The temperature function performs a self test when initially powered on and also performs system tests automatically, every 10 seconds, while this function is active.

<b>System Message</b>	<b>Cause</b>
<i>CHECK PROBE</i>	The temperature probe is disconnected. Check probe and reconnect it.
<i>PROBE FAILURE</i>	The temperature probe is defective. Replace the Temperature probe.
<i>TEMP DISABLED</i>	A system error has occurred. The X Series unit cannot take temperature measurements and should be serviced.

# Chapter 13

## Automated External Defibrillator (AED) Operation

---



ZOLL hands-free therapy electrodes are a defibrillation-protected Type BF patient connection.

---

**WARNING!** Use only pediatric electrodes to defibrillate patients under 8 years of age in AED mode, and make sure the patient mode is set to pediatric. Use of adult electrodes or adult mode with pediatric patients can result in the delivery of excessive energy doses.

---

This chapter describes the recommended method of operation in AED Mode. The X Series unit is configured to operate in compliance with the American Heart Association and European Resuscitation Council Guidelines for Adult Basic Life Support and Use of Automated External Defibrillators.<sup>1,2,3,4</sup> If your local protocol requires a different procedure, follow that protocol.

The AED Mode is Supervisor configurable, and when the unit is configured to start up in AED Mode, it powers up in the Analysis/CPR Protocol, and guides you through a cardiac event by performing ECG analysis, preparing the device for a shock (if needed), and leading you through a CPR interval.

This chapter also describes how to switch the AED unit to Manual mode (see “Switching to Manual Mode Operation” on page 14-10).

- 
1. *Circulation*, 2005; 112; IU-19 — IU-34
  2. *Resuscitation* (2005); 671S, S7-S23
  3. *Circulation* 2010; 122; S640-S656
  4. *Resuscitation* (2010); 1219-1276

In AED operation, there is an Analysis/CPR Protocol mode guides you through a cardiac event by performing ECG analysis, preparing the device for a shock (if needed), and leading you through a CPR interval. This cycle is repeated as long as Analysis/CPR Protocol is active and pads are attached to the patient. If pads become detached from the patient or shorted during the Analysis/CPR Protocol, the protocol halts and waits for the pads to be reattached or continues through the CPR interval and then halts and waits for the pads to be reattached.

The X Series defibrillator is capable of analyzing a patient's ECG rhythm in two different ways. The first mode of analyzing is automatic; the other mode of analyzing is user activated analysis and is initiated by pressing the **ANALYZE** button.

Automatic and user activated analysis of a patient's ECG can be performed only when:

- Hands-free therapy electrodes are connected, and making good contact with the patient.
- The defibrillator is on.

The analysis determines if there is a shockable rhythm and if a shockable rhythm is present prompts the operator to shock the patient at the preconfigured energy level. If the analysis does not detect a shockable rhythm, the unit alerts the operator that no shock is advised.

If the **SHOCK** button is pressed and a shock is successfully delivered, the shock count increments by one and is displayed on the screen.

## AED Operation

### Determine Patient Condition Following Medical Protocols

Verify:

- Unconsciousness.
- Absence of breathing.
- Absence of pulse.

### Begin CPR Following Medical Protocols

Request additional assistance.

---

## Prepare Patient

Remove all clothing covering the patient's chest. Dry chest if necessary. If the patient has excessive chest hair, clip or shave it to ensure proper adhesion of the electrodes.

Attach hands-free therapy electrodes according to instructions on the electrode packaging.

Ensure that the electrodes are making good contact with the patient's skin and are not covering any part of the ECG electrodes.

Connect the hands-free therapy electrodes to the multi-function cable (MFC or OneStep) if not already connected.

The message *ATTACH PADS* or *CHECK PADS* will be displayed and energy will not be delivered if the therapy electrodes are not making good contact with the patient. The message *SHORT DETECTED* is displayed if a short circuit exists between the therapy electrodes.

**Note:** Since analysis is only done using Pads as a lead, even if an ECG cable is connected and Lead II is available, the unit still displays a *CHECK PADS* message.

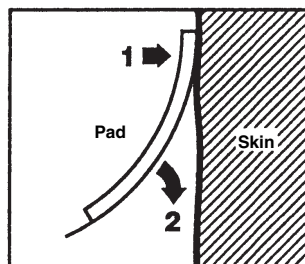
## Therapy Electrode Application

---

**WARNING!** Poor adherence and/or air under the therapy electrodes can lead to the possibility of arcing and skin burns.

---

1. Apply one edge of the pad securely to the patient.
2. Roll the pad smoothly from the applied edge to the other, being careful not to trap any air pockets between the gel and skin.

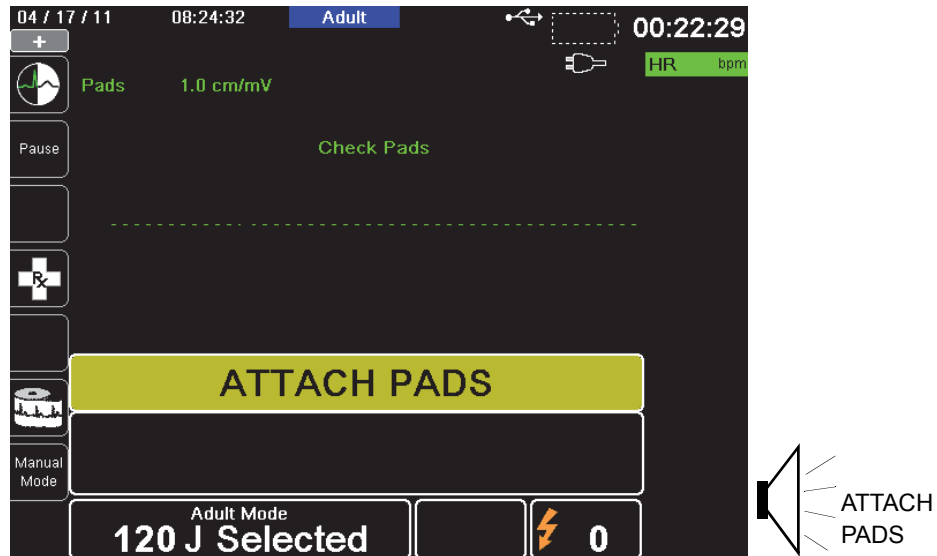


**Note:** If it is not possible to place the "BACK" pad on the patient's back, the pads should be placed in the standard apex-sternum positions. Effective defibrillation will result, but pacing will usually be less effective.

## 1 Turn on unit

Press the green power switch located on the top of the unit. The green, yellow, and red lights on the top of the unit flash on and off, and then displays the message *SELF TEST PASSED*.

If no hands-free therapy electrodes have been attached to the patient and connected to the X Series unit, the *ATTACH PADS* message and voice prompt will be issued.



### Energy Select

The default energy selections for adult patients are:

- Shock 1 - 120 joules
- Shock 2 - 150 joules
- Shock 3 - 200 joules

The default energy selections for pediatric patients are:

- Shock 1 - 50 joules
- Shock 2 - 70 joules
- Shock 3 - 85 joules

**Note:** Pediatric defibrillator energy levels should be selected based on site specific protocols.

**Note:** If the X Series unit has been configured to begin CPR upon start up, it will automatically begin with the CPR interval.

## 2 Analyze

**WARNING!** Do not analyze the patient ECG during patient movement. A patient must be motionless during ECG analysis. Do not touch the patient during analysis. Cease all movement via stretcher or vehicle before analyzing the ECG.

The X Series automatically begins the analysis of the patient's ECG rhythm, displays an ANALYZING ECG message for 5 seconds, and announces and displays a *STAND CLEAR* message. If therapy electrodes have not been properly connected to the patient, an *ATTACH PADS* or *CHECK PADS* message is displayed and analysis will be inhibited.

**Note:** You can press **Pause** to temporarily stop the rescue cycle. While the rescue cycle is paused, ECG analysis continues in the background. The trends, log, alarm monitoring, and 12-lead features are only accessible when the rescue cycle is paused. Press **Analyze** to resume the analysis process.

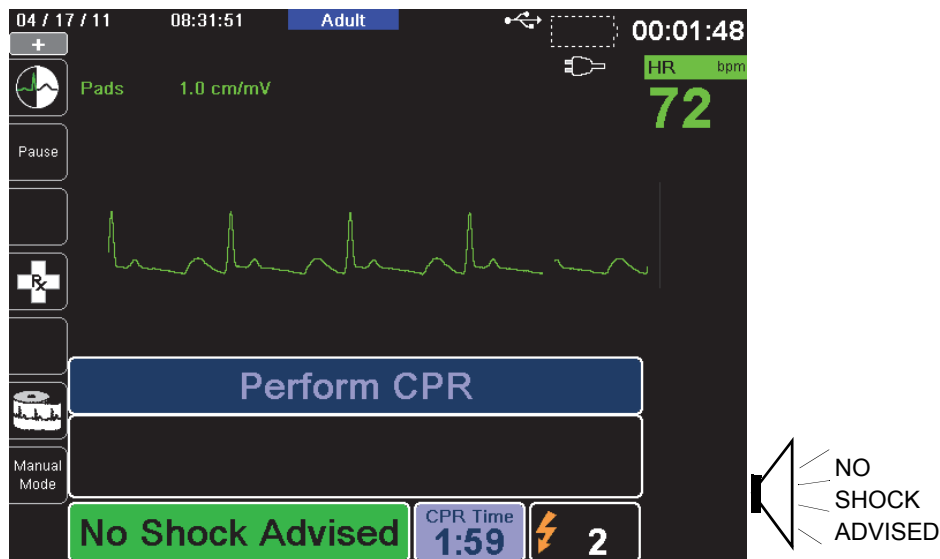
**Note:** If the X Series has been configured to perform extra CPR at startup, it displays a *CHECK PULSE* voice prompt and the message appears for 10 seconds. Then it displays a *PERFORM CPR* message along with a voice prompt for the configured duration before analysis begins. You can start an ECG analysis during the CPR interval by pressing the **ANALYZE** button.



An ANALYZING ECG message is displayed while the patient's ECG is analyzed. Once the analysis is completed, the unit indicates whether or not a shock is advised.

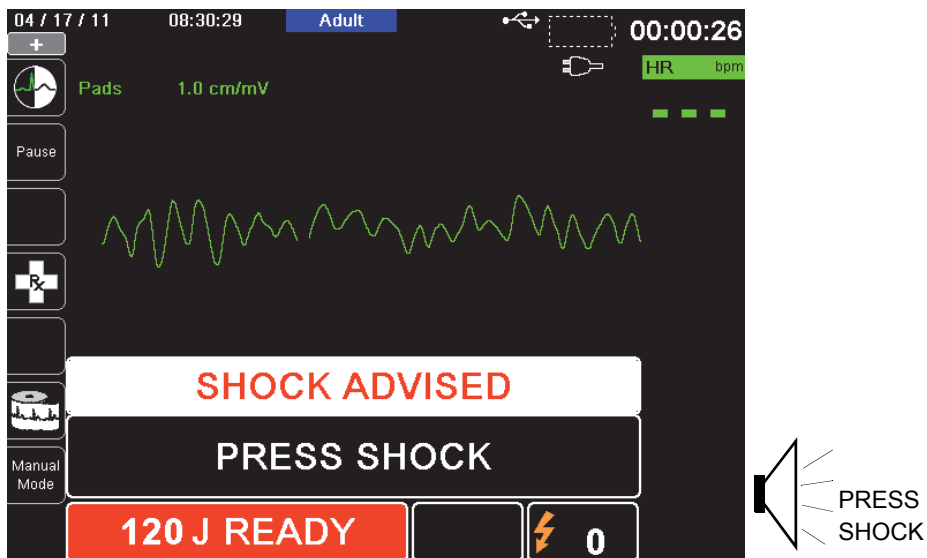
**WARNING!** ECG rhythm analysis does not warn of patient asystole, which is not a shockable rhythm.

When a nonshockable rhythm is detected, the unit displays a *NO SHOCK ADVISED* message. Immediately begin chest compressions and continue other treatment per protocol.



If the patient's rhythm is shockable, the unit displays the *SHOCK ADVISED* and *PRESS SHOCK* messages. The defibrillator automatically prompts the operator to shock the patient at the preconfigured energy level and the **SHOCK** button illuminates.

A continuous tone sounds for 20 or 50 seconds (depending on configuration), followed by a higher pitch tone for 10 seconds. You must deliver the shock within this 30 or 60 second interval (depending on configuration), or the defibrillator will disarm itself.





### 3 Press SHOCK

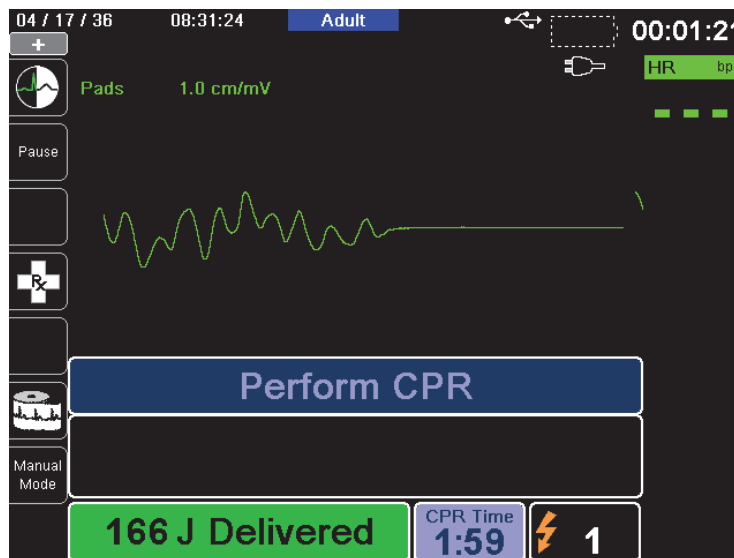
**WARNING!** Warn all persons in attendance of the patient to **STAND CLEAR** prior to defibrillator discharge.

**Do not touch the bed, patient, or any equipment connected to the patient during defibrillation. A severe shock can result. Do not allow exposed portions of the patient's body to come in contact with metal objects, such as a bed frame, as unwanted pathways for defibrillation current may result.**

**Press and hold the illuminated SHOCK button on the front panel until energy is delivered to the patient.**

Observe the patient or ECG response to verify that the shock has been delivered.

The delivered energy level and the shock number (1) are displayed in the panel at the bottom of the screen.



#### Perform CPR

Begin chest compressions and rescue breathing per local protocol as prompted by the unit.

**Note:** If ZOLL OneStep CPR pads, OneStep Complete pads or CPR-D-padz are connected, the unit monitors the rate and depth of chest compressions and can display *PUSH HARDER* and *GOOD COMPRESSIONS* messages and voice prompts.

#### Repeat Analysis

After performing CPR for the configured period of CPR, the unit will restart ECG analysis automatically.

**Note:** Reanalysis of the ECG rhythm is inhibited for 3 seconds after a shock.

#### Stop CPR

After performing CPR for the configured period of CPR, the unit will issue a *STOP CPR* prompt while it restarts ECG analysis.

#### Continue Patient Care

Continue patient care according to medical protocols.

## RapidShock

RapidShock™ analysis algorithm provides ultrafast shock/no-shock decision. RapidShock is available in AED mode only or in both AED and Rescue Protocol modes of operation. For further information and how to enable/disable this feature, consult the X Series Configuration Manual.

**Note:** RapidShock is only available in Adult mode and when one of the following electrodes is used: ZOLL OneStep CPR electrodes, OneStep Complete electrodes, CPR-D-padz, or CPR Stat padz.

---

**WARNING!** Performance of the RapidShock Mode has not been demonstrated in patients under 8 years of age or less than 55 lbs (25 kg).

---

## The Shock Conversion Estimator

Shock Conversion Estimator takes the output of the analysis algorithm and performs additional analysis to estimate the probability of whether or not the current ECG can successfully be converted by electrical therapy. If the probability of a successful shock is low, the system will advise against a shock and instead instruct to continue CPR as this may be more beneficial to victim resuscitation efforts.

For more information on enabling/disabling the Shock Conversion Estimator feature, please refer to the *X Series Configuration Manual*.

---

**WARNING!** Performance of the Shock Conversion Estimator has not been demonstrated in patients under 8 years of age or less than 55 lbs (25 kg).

---

## Operating Messages

The unit uses both audio and visual prompts to present critical information to operators. The following information describes the unit default configuration. If your device has been custom configured, some of the information may be different.

There are 10 voice prompts used in AED mode. Most of these prompts are accompanied by a message displayed on the monitor. The voice prompts are given only once, but the monitor continues to display the message until new action is taken by the operator or the device status changes.

The unit will alternately display two different messages in the same field of the display when two conditions are detected at the same time. For example, a *LOW BATTERY* message may alternately display on the same line of the monitor as the *CHECK PADS* message.

---

## Audio and Display Messages

The display messages and voice prompts that can occur during AED operation are described below.

### **ATTACH PADS**

If the unit is powered on without therapy pads connected to the patient, the *ATTACH PADS* message is announced and displayed.

### **ANALYZING ECG/STAND CLEAR**

The *ANALYZING ECG* message is displayed and the *STAND CLEAR* message is displayed and announced when the ECG analysis starts automatically or after pressing the **ANALYZE** button. They indicate that an active ECG analysis is in progress.

### **SHOCK ADVISED**

A shockable rhythm has been detected and defibrillation is advised. The selected energy level is displayed.

### **PRESS SHOCK**

This message is displayed and announced when the ECG analysis has determined that a shock is advised and the selected energy is ready to be delivered.

### **SHOCKS: XX**

This message displays the number of shocks that have been delivered by the unit since it was powered on. It resets to 0 after the unit has been off for more than two minutes.

### **NO SHOCK ADVISED**

When ECG analysis detects a nonshockable rhythm, this message is announced and displays for 10 seconds following completion of the analysis.

### **CHECK PULSE**

If configured to do so, this message is displayed and announced in the following situations:

- After a No Shock Advised analysis result
- During the CPR interval after a No Shock Advised analysis result
- After the final shock is delivered

### **IF NO PULSE, PERFORM CPR**

If configured to do so, this message is displayed and announced in the following situations:

- During the CPR interval after a No Shock Advised analysis result
- During the start of extra CPR interval

### **PERFORM CPR**

If configured to do so, this message is displayed and announced during the CPR interval after a No Shock Advised analysis result.

### **STOP CPR**

After performing CPR for the configured period, the unit will issue a *STOP CPR* prompt while it restarts ECG analysis.

### **PUSH HARDER**

This message is announced when the chest compressions applied during CPR are not deep enough.

### **GOOD COMPRESSIONS**

This message is announced when the chest compressions applied during CPR are deep enough.

### **CHECK PADS**

This message is displayed and announced when the therapy pads have been disconnected from the patient.

### **CHECK PATIENT**

This message is displayed and announced when the unit is paused and detects a shockable rhythm during continuous background ECG analysis. The prompt persists as long as a shockable rhythm is being detected. Press the **ANALYZE** button to resume ECG analysis.

## **Switching to Manual Mode Operation**

Press the **Manual Mode** quick access key on the front panel of the unit to enter the Manual mode of operation.

Using the navigation keys, select the four digits in the Manual Mode pass code. Press **SAVE** when you are finished. Once you have entered your pass code, you will be able to enter Manual mode.

**Note:** If the unit has not been configured to enter a pass code, the message *Exit to Manual Mode* is displayed. Use the navigation keys to select **Yes** to enter the Manual mode of operation. If you do not press **Yes** within 10 seconds, the unit will revert back to AED operation.

When changing from AED mode to Manual mode, the current selected energy level is maintained.

**Note:** To transfer back to AED mode from Manual mode, power down the unit for more than 30 seconds and less than two minutes, then power it back up. If you wait longer than two minutes, the unit will reset the settings to the defaults and treat the case as a new patient.

# Chapter 14

## 12-Lead ECG Interpretive Analysis

---

The X Series 12-Lead input is Type CF defibrillator proof.

This chapter describes how to use the X Series unit to monitor 12-Lead ECG for adult and pediatric patients, and how to display 12-Lead ECG Interpretive Analysis information for adult patients.

X Series 12-Lead ECG Monitoring provides simultaneous acquisition and storage of 12-Lead information for adult and pediatric patients, and, when enabled, post-acquisition Interpretive Analysis for adult patients.

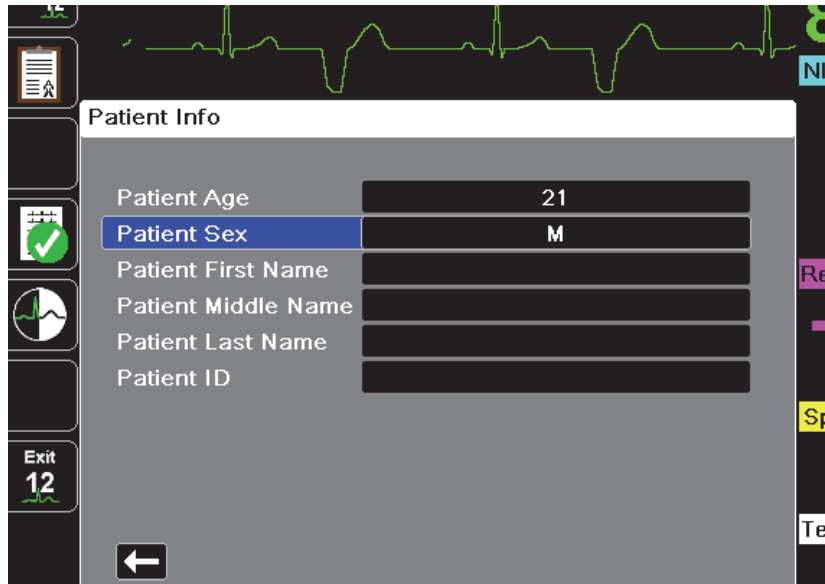
---

- Warning!**
- **12-Lead ECG monitoring is intended for the recording of 12-lead ECG signals from adult and pediatric patients in the supine, resting position -- always ensure that the patient is kept motionless during 12-lead ECG signal acquisition and analysis. Use of the device to acquire ECG signals from moving or shaking patients may produce noisy signals that are difficult to interpret.**
  - **The 12-Lead Interpretive algorithm's interpretive statements are designed to enhance the diagnostic process. They are no substitute for the qualified judgment of a properly trained clinician. As with any diagnostic test, always give consideration to patient symptoms, history, and other relevant factors.**
  - **12-Lead Interpretive Analysis is for use with *only* adult patients.**
  - **It is important to enter each patient's age and gender prior to performing ECG analysis using the Inovise 12L Interpretive Algorithm. Providing patient age and gender will ensure that highest accuracy of ECG analysis is attained. If age is not provided, a default of 45 years is used. If gender is not provided, the default is male.**
  - **Excessive body hair or wet, sweaty skin may interfere with electrode adhesion. Remove the hair and/or moisture from the area where the electrode is to be attached.**
  - **Remove ECG electrodes from their sealed package immediately prior to use. Using previously opened or out-of- date electrodes may degrade the ECG signal quality.**

- **Monitoring electrodes may become polarized during defibrillator discharge, causing the ECG waveform to briefly go off screen. ZOLL Medical Corporation recommends the use of high quality silver/silver chloride (Ag/AgCl) electrodes to minimize this effect; the circuitry in the instrument returns the trace to the monitor display within a few seconds.**
  - **Wait 15 seconds after defibrillator discharge before attempting a 12-lead acquisition. Electrode polarization subsequent to defibrillator discharge may result in excessive noise on the 12-lead ECG printout.**
  - **When not in use, cover the patient cable's V-lead connector with the supplied plastic cap. Failure to do so may result in a shock hazard during defibrillation attempts.**
  - **To assure protection against the effects of defibrillator discharge, use only 12-lead cables supplied by ZOLL Medical Corporation.**
  - **Check the operation and integrity of the X Series unit and 12-lead cable regularly by performing the Daily Operational Verification Test.**
  - **When attempting to interpret subtle ECG changes (such as ST segments) use only the Diagnostic frequency response setting. Other frequency response settings may cause misinterpretation of the patient's ECG.**
  - **Use only ZOLL-approved accessories to ensure the Type CF defibrillator proof rating of the 12-Lead input.**
  - **Implanted pacemakers may cause the heart rate meter to count the pacemaker rate during incidents of cardiac arrest or other arrhythmias. Carefully observe pacemaker patients. Check the patient's pulse; do not rely solely on heart rate meters. Dedicated pacemaker detection circuitry may not detect all implanted pacemaker spikes. Patient history and physical exam are important in determining the presence of an implanted pacemaker.**
-

## Entering Patient Information

To enter patient information, press the **12-Lead** quick access key (12), then the Patient Info quick access key (Patient Info icon). The screen displays the Patient Info parameter panel, in which you can enter the patients's name, age, gender, and identification number:



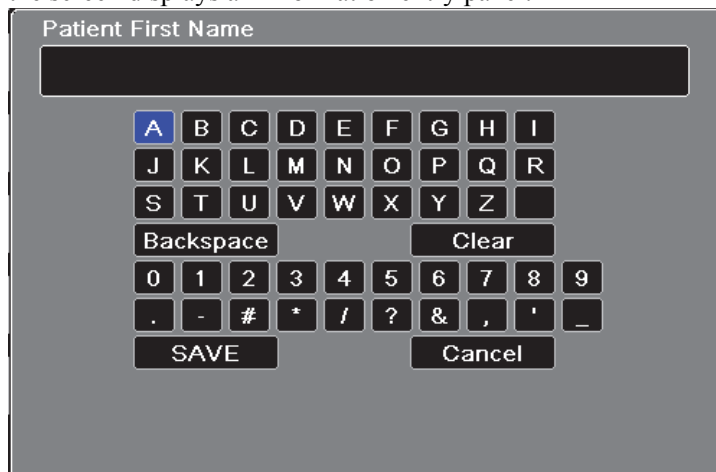
**Figure 14-1 Patient Info Control Panel**

The X Series unit uses the name that you enter in the Patient Info panel to label the 12-lead ECG monitoring snapshots that it saves.

To enter patient information, use the navigation keys to highlight and select a parameter on the Patient Info panel, then press the **Select** key.



## Entering the Patient Name and ID

When you select the **Patient First Name** field (or the Patient Middle/Last Name, or ID fields), the screen displays an information entry panel:



To enter a character into the parameter, highlight the character, then press **Select**. The screen displays the selected character in the area below the parameter name.

To navigate through the information entry panel, use the following keys:

- Use the Row Up quick access key () to move to the previous row on the panel.
- Use the Row Down quick access key () to move down one row on the panel.

Use the navigation keys on the front panel to highlight the next or previous character on the information entry panel.

You can also select the following function keys on the information entry panel:

- **Backspace** Erases the last character entered.
- **Clear** Erases all characters entered.
- **SAVE** Saves the characters entered for that parameter and returns you to the Patient Info panel.
- **Cancel** Returns you to the Patient Info panel without saving the characters entered.

## Entering Patient Age and Gender

The Patient Info parameter panel provides default values for the Patient Age and Patient Gender parameters. To change a default value, highlight and select the parameter, and then specify a new value as follows:

To change Patient Age, use the navigation keys on the front panel to decrease or increase the default value (45), then press **Select**.

To change Patient Gender, use the navigation keys on the front panel to toggle between the default value, M (male), and F (female), then press **Select**.

**Note:** It is important that you provide the patient's age and gender prior to performing ECG analysis using the Inovise 12L Interpretive Algorithm. Entering the correct age and gender ensures that the highest degree of ECG analysis is obtained. If you do not enter the patient's age or gender the X Series uses the default age (45 years) and default gender (male). See "12-Lead Interpretive Analysis" on page 14-8.

## 12-Lead ECG Monitoring Setup

The proper application and placement of electrodes is essential for high quality 12-Lead ECG monitoring. Good contact between the electrode and skin minimizes motion artifact and signal interference.

To set up 12-lead ECG monitoring, perform the following steps:

1. Prepare the patient's skin for electrode application.
2. Apply the electrodes to the patient.
3. Connect each lead of the ECG cable to the appropriate electrode.
4. Connect the 12-Lead cable to the X Series unit.
5. Observe the patient's electrocardiogram on the display, and adjust size of the 12-Lead ECG waveform traces, as necessary.



## Preparing the Patient for Electrode Application

The proper application of electrodes is essential for high quality ECG monitoring. Good contact between the electrode and skin minimizes motion artifact and signal interference.

Before applying electrodes, prepare the patient's skin, as necessary:

- Shave or clip excess hair at electrode site.
- Clean oily skin with an alcohol pad.
- Rub site briskly to dry.

## Applying Electrodes to the Patient

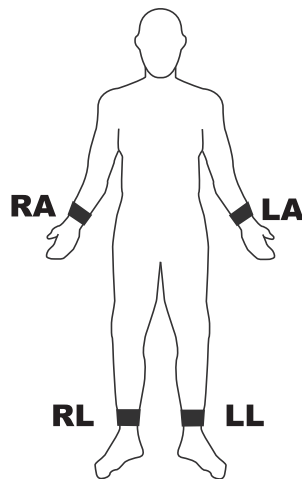
Depending on local usage, ECG lead wires are marked with certain labels. Refer to the following table for labels and color codes for the different lead sets

Location	AHA <sup>1</sup> Labels	IEC <sup>2</sup> Labels
Right Arm	RA (white)	R (red)
Left Arm	LA (black)	L (yellow)
Right Leg	RL (green)	N (black)
Left Leg	LL (red)	F (green)
Chest	V1	C1
Chest	V2	C2
Chest	V3	C3
Chest	V4	C4
Chest	V5	C5
Chest	V6	C6

<sup>1</sup> American Heart Association

<sup>2</sup> International Electrotechnical Commission

Patients should be in a resting, supine position when performing 12-Lead ECG monitoring. ZOLL Medical Corporation recommends placing the limb electrodes anywhere along the ankles and wrists.



Avoid placing electrodes over tendons and major muscle masses.

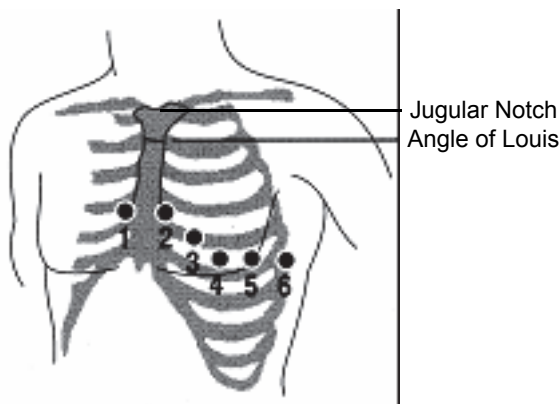
Make sure that the ECG electrodes are placed to allow defibrillation, if necessary.

Place the precordial electrodes across the chest in the following locations:

Electrode	Placement
V1/C1	Fourth intercostal space, at the patient's right sternal margin.
V2/C2	Fourth intercostal space, at the patient's left sternal margin.
V3/C3	Midway between V2/C2 and V4/C4.
V4/C4	Fifth intercostal space, on the patient's midclavicular line.
V5/C5	Patient's left anterior axillary line, at the horizontal level of V4.
V6/C6	Patient's left midaxillary line, at the same horizontal level as V4 and V5.

Locating the V1/C1 position (fourth intercostal space) is critically important because it is the reference point for locating the placement of the remaining V-leads. To locate the V1/C1 position:

1. Place your finger on top of the jugular notch (see figure below).
2. Move your finger slowly downward about 1.5 inches (3.8 centimeters) until you feel a slight horizontal ridge or elevation. This is the "Angle of Louis," where the manubrium joins the body of the sternum.



3. Locate the second intercostal space on the patient's right side, lateral to and just below the "Angle of Louis."
4. Move your finger down two more intercostal spaces to the fourth intercostal space which is the V1 position.

**Note:** When placing electrodes on female patients, always place leads V3-V6 under the breast rather than on the breast.

## Connecting the 12-Lead Cable

Connect the 12-Lead ECG cable to the ECG input connector on the left side of the unit as follows:

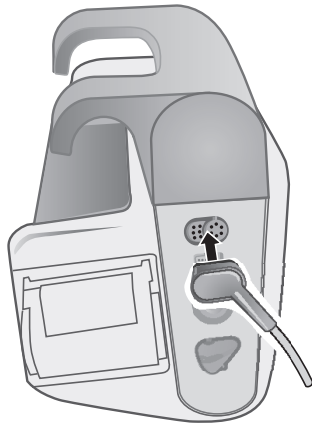
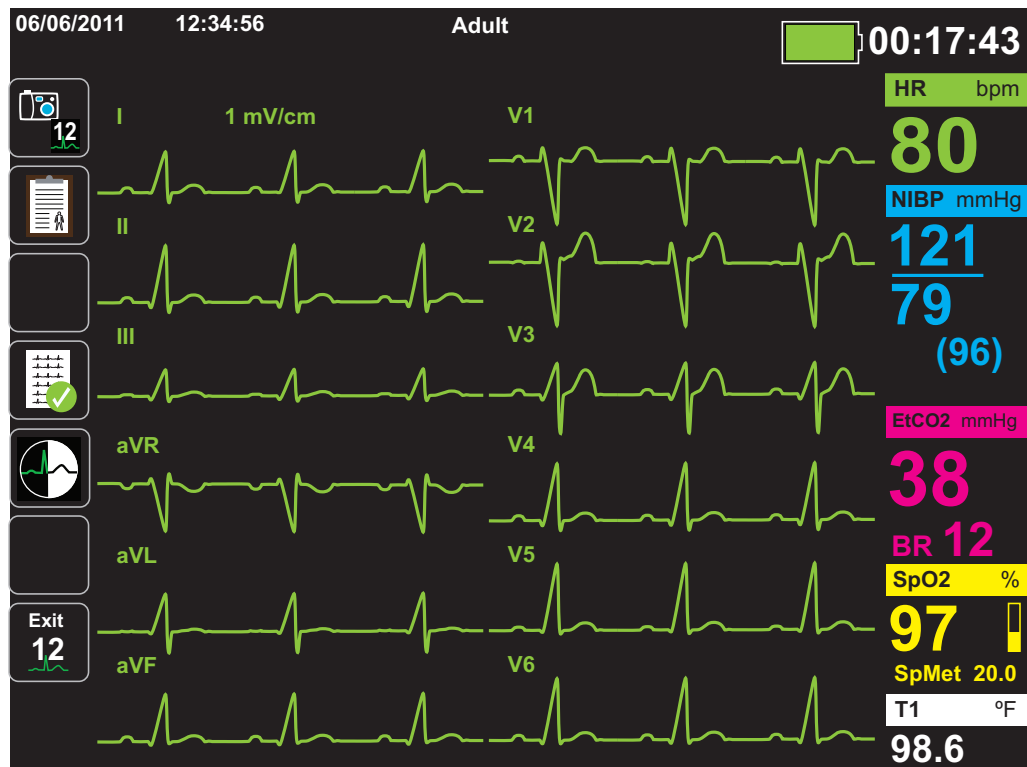


Figure 14-2 Connecting the 12-Lead ECG Cable

## Observing the 12-Lead Waveform Traces


To observe the 12-Lead waveform traces, press **12**. The screen displays all twelve waveform traces, with the size displayed above the waveform traces:

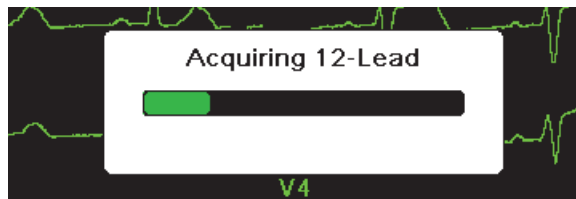


## 12-Lead Interpretive Analysis

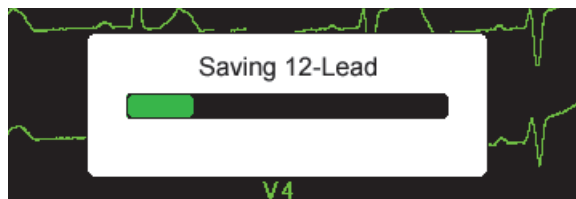
After observing the patient's ECG and determining that all 12-lead traces display correctly, you can initiate 12-Lead Interpretive Analysis (12-Lead Interpretive Analysis *must* be enabled through the Supervisor Menu).

**Note:** 12-Lead Interpretive Analysis is for Adult patients only. It is important that you provide the patient's age and gender prior to performing ECG analysis using the Inovise 12L Interpretive Algorithm. Entering the correct age and gender ensures that the highest degree of ECG analysis is obtained. If you do not enter the patient's age or gender the X Series uses the default age (45 years) and default gender (male). See "Entering Patient Information" on page 14-3.

To begin 12-Lead Interpretive Analysis, press the **Acquire** quick access key (). If the Patient Info panel displays provide the patient's information by using the navigation keys to highlight and select a parameter on the Patient Info panel, then press the **Select** key (see "Entering Patient Information" on page 14-3). The X Series unit displays the *Acquiring 12-Lead* Status bar as it collects 10 seconds of 12-Lead ECG data:

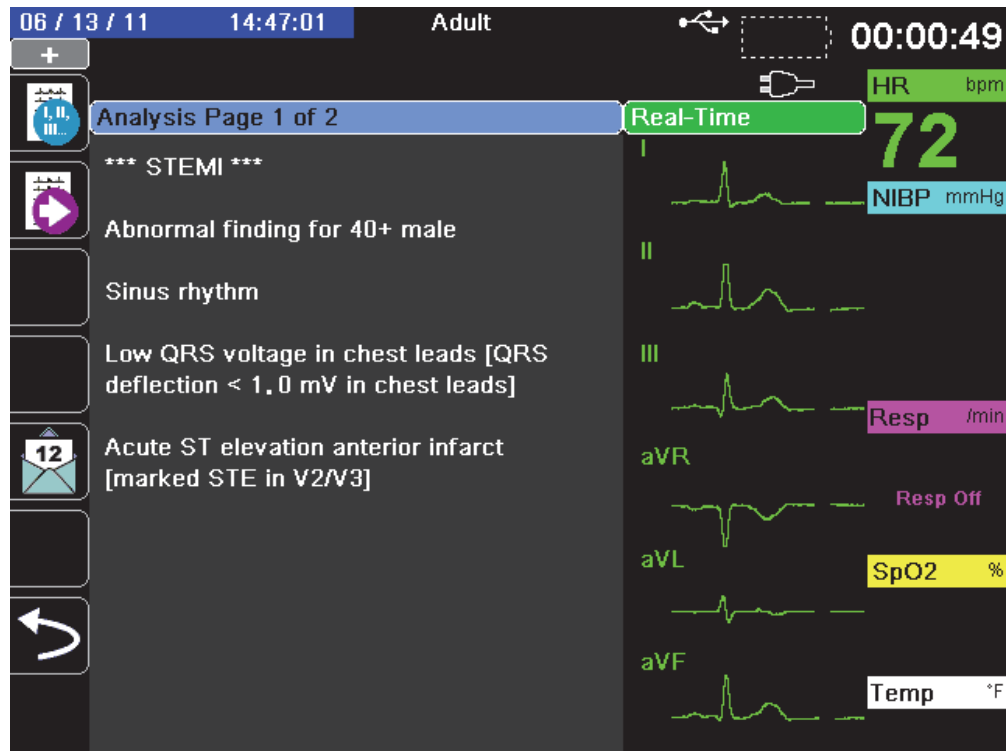


After acquiring the ECG data, the unit saves the data and displays the *Saving 12-Lead* Status Bar in the following manner:




After saving the data, the unit performs the post-acquisition analysis and displays the first page of 12-Lead Analysis information. If Lead Analysis is enabled and Interpretive Text is set to On, the first page of the 12-Lead Analysis information includes interpretive statements. Otherwise, the first page shows the numeric analysis results only.

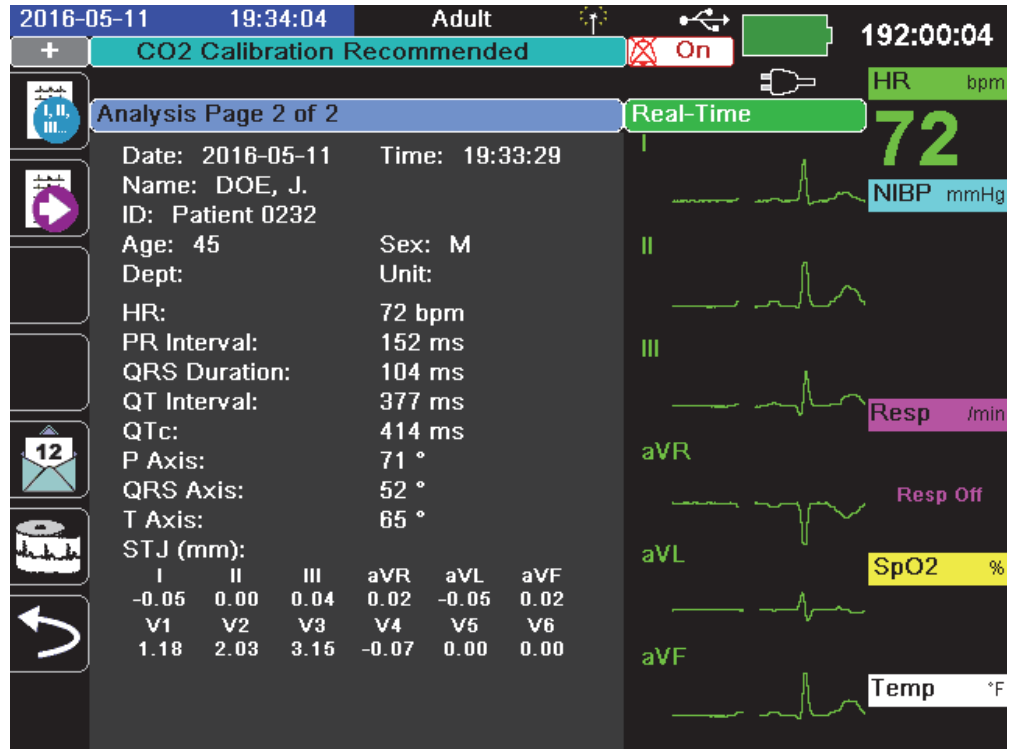
**Note:** 12-Lead Interpretive Analysis and Interpretive Text are enabled through the Supervisor Menu.




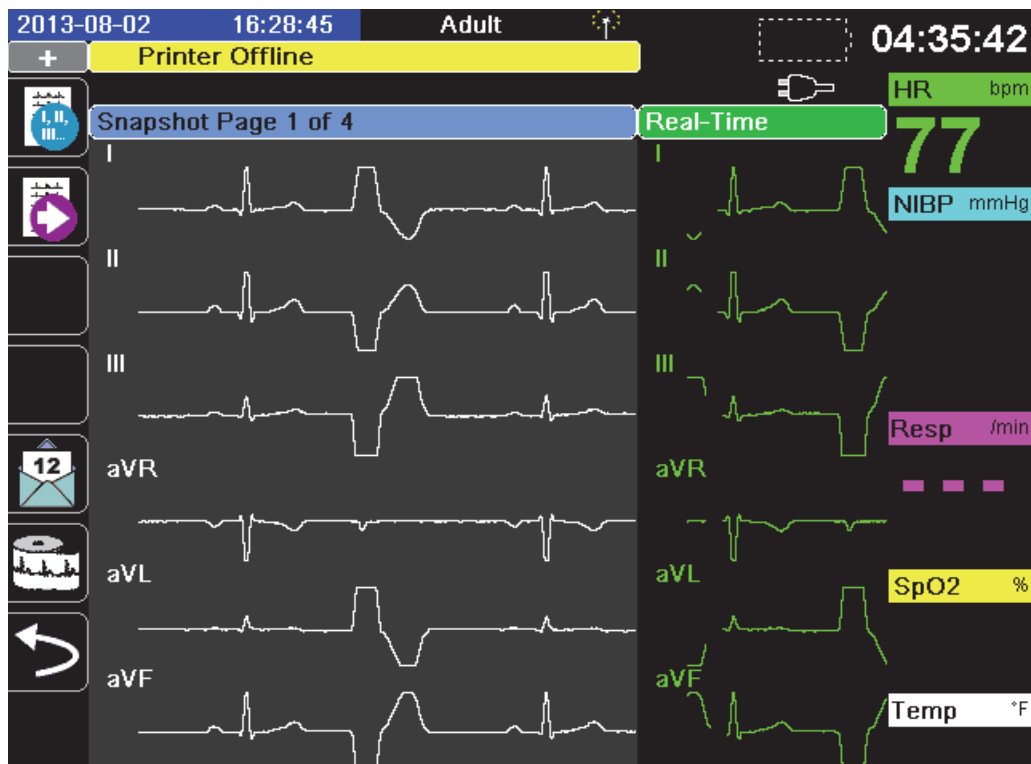
In the example above, the interpretive statement, **\*\*\*STEMI\*\*\***, indicates the occurrence of ST-Elevation Myocardial Infarction. The interpretive statements that the X Series unit displays are produced by the Audicor software of Inovise Medical, Inc. For more information on these interpretive statements, see the *Inovise 12L Interpretive Algorithm Physician's Guide*.

To display *Analysis Page 2*, press the **12-Lead Review Next** quick access key (  ).

*Analysis Page 2* displays the identifying information that has been entered for the patient and additional analysis statements:



You can then view four 12-Lead snapshot pages by pressing  to step through them sequentially. For example, the unit displays the following 12-Lead snapshot after the *Analysis Page 2*:




## Fault Conditions Affecting 12-Lead Interpretive Analysis

The X Series unit will not perform Interpretive Analysis if it detects one of the following fault conditions when attempting to acquire 12-Lead data:


- A pacer signal is present.
- A lead fault is detected in the ECG cable.
- An invalid cable is in use.


If the X Series unit detects one of these fault conditions, *Analysis Page 1* indicates that there is *No data available* for Interpretive Analysis and lists the fault condition; all measurements on *Analysis Page 2* appear as *N/A*.



Once you have corrected the fault condition, press  to confirm the correction and perform the 12-Lead Interpretive Analysis.

## Printing 12-Lead Waveform Traces

Once you have determined that the X Series unit is correctly setup for 12-Lead ECG monitoring, you can print the 12-Lead ECG traces for review and analysis.

Press  to collect 10 seconds of 12-Lead data for print.


Press the **Print** quick access key () to print a 12-lead snapshot, which begins with a header that gives the date, time, and patient information, followed by 2.5 second samples of all twelve waveform traces. The waveform traces print according to the 12-Lead print format currently set up for your system. See “12-Lead Print and Display Options” on page 14-13 for a description of the various 12-Lead print formats. The X Series unit stores a minimum of 32 12-Lead snapshots in a separate log. Once 32 12-lead snapshots are stored, the oldest snapshot in the log is overwritten by subsequent snapshots. Note that if a patient data log is full, you will not be able to store 12-lead snapshots. The 12-lead snapshots are erased when you clear the log.

When you are done viewing and printing the 12-Lead waveform traces, press the **Exit 12** quick access key () or the Home/Display button () to restore the display of other monitoring functions.

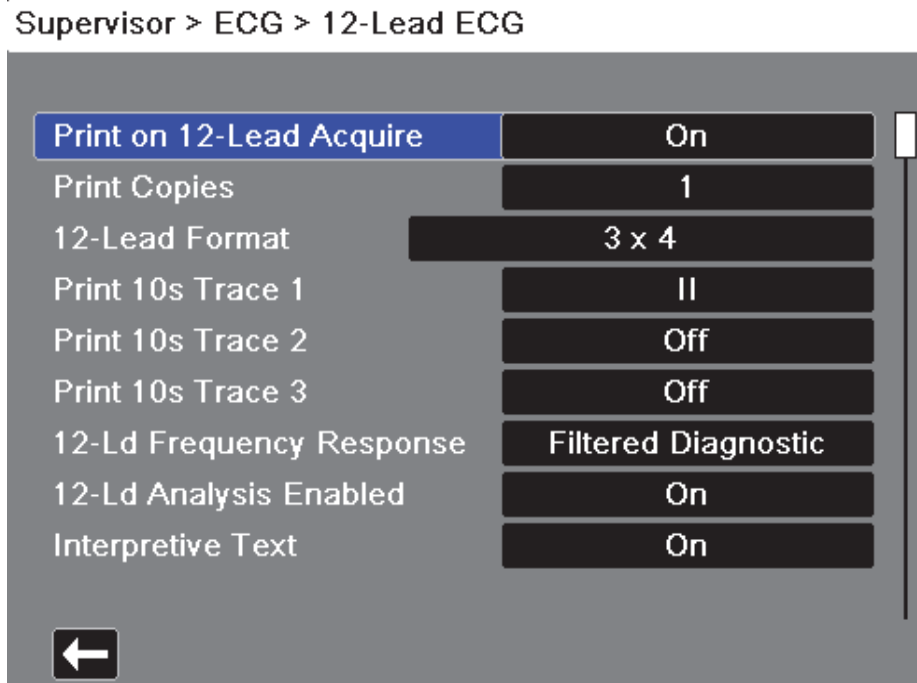


## 12-Lead Print and Display Options


The X Series unit provides additional 12-Lead print and display options that you can specify through the Supervisor parameter control panels (access to Supervisor is passcode-controlled).

Press the **Setup** quick access key () , then select **Supervisor**. Using the navigation keys, select the four digits in the **Supervisor** passcode. Press **SAVE** when you are finished. Once you have entered your supervisor passcode, you will be able to access the configurable options in the Supervisor menu.


Select the **Supervisor> ECG> 12-Lead** option to display the 12-Lead parameter control panel:



### Selecting 12-Lead Acquire

When enabled, the unit automatically prints the 12-Lead report when you press  . By default, this feature is not enabled.

### Specifying the Number of 12-Lead Print Copies

This option allows you to specify that the X Series unit print up to five copies of the 12-lead waveform trace set after pressing  . By default, the unit prints only one 12-lead snapshot.

## Specifying the 12-Lead Print Format

This option allows you to specify the print format for the 12-lead waveform traces: 3 x 4 (the default), 2 x 6, 3 x 4 Cabrera, 3 x 4 Hybrid, 3 x 4 Cabrera Hybrid format. Each of the 12-lead print formats are described below.

### 3 x 4 (default)

The 3 x 4 format provides 10 seconds of standard 12-lead ECG data printed in four staggered 2.5 second segments as follows:

I, II, III	0 to 2.5 seconds
aVR, aVL, aVF	2.5 to 5.0 seconds
V1, V2, V3	5.0 to 7.5 seconds
V4, V5, V6	7.5 to 10.0 seconds

### 2 x 6,

The 2 x 6 format provides 2 columns of 6 leads each. The time frame for the 2 x 6 print format depends on the 12-Lead Analysis page currently displayed on the X Series device as follows:

Page 1:	0.0 - 2.5 Seconds
Page 2:	2.5 - 5.0 Seconds
Page 3:	5.0 - 7.5 Seconds
Page 4:	7.5 - 10.0 Seconds

### 3 x 4 Cabrera

The 3 x 4 Cabrera format prints 10 seconds of Cabrera 12-lead ECG data printed in four staggered 2.5 second segments as follows:

aVL, I, -aVR	0 to 2.5 seconds
II, aVF, III	2.5 to 5.0 seconds
V1, V2, V3	5.0 to 7.5 seconds
V4, V5, V6	7.5 to 10.0 seconds

### 3 x 4 Hybrid

How the 3 x 4 hybrid format prints depends on where the printing of the 12-Lead ECG data is initiated. When initiated from:

- **12-Lead Acquire or 12 Lead Analysis Pages 1 and 2**

With automatic print on 12-Lead Acquire or when printing from 12-Lead Analysis Page 1 or 2, the 3 x 4 Hybrid format prints the 12-lead ECG data in four staggered 2.5 second segments as follows:


I, II, III	0 to 2.5 seconds
aVR, aVL, aVF	2.5 to 5.0 seconds
V1, V2, V3	5.0 to 7.5 seconds
V4, V5, V6	7.5 to 10.0 seconds

- **12-Lead Snapshot Pages 1-4**

When printing while viewing pages 1-4 of the 12-Lead snapshot, this format prints the 12-lead ECG data in four non-staggered 2.5 second segments. The time frame of the printout depends on the current 12-Lead Snapshot page being viewed.

Where	Prints
Page 1	0 to 2.5 seconds
Page 2	2.5 to 5.0 seconds
Page 3	5.0 to 7.5 seconds
Page 4	7.5 to 10.0 seconds

- **When 12-Lead Analysis is not Available**

If 12-Lead Analysis is not available on your system, the 3 x 4 Hybrid format prints the 12-lead ECG data in four non-staggered 2.5 second segments. An additional Staggered icon () is available that allows you to print the ECG data in four staggered 2.5 second segments if desired.

### 3 x 4 Cabrera Hybrid

How the 3 x 4 hybrid format prints depends on where the printing of the 12-Lead ECG data is initiated. When initiated from:

- **12-Lead Acquire or 12 Lead Analysis Pages 1 and 2**

With automatic print on 12-Lead Acquire or when printing from 12-Lead Analysis Page 1 or 2, the 3 x 4 Cabrera Hybrid format prints the 12-lead ECG data in four staggered 2.5 second segments as follows:


aVL, I, -aVR	0 to 2.5 seconds
II, aVF, III	2.5 to 5.0 seconds
V1, V2, V3	5.0 to 7.5 seconds
V4, V5, V6	7.5 to 10.0 seconds

- **12-Lead Snapshot Pages 1-4**

When printing while viewing pages 1-4 of the 12-Lead snapshot, this format prints the 12-lead ECG data in four non-staggered 2.5 second segments. The time frame of the printout depends on the current 12-Lead Snapshot page being viewed.

Where	Prints
Page 1	0 to 2.5 seconds
Page 2	2.5 to 5.0 seconds
Page 3	5.0 to 7.5 seconds
Page 4	7.5 to 10.0 seconds

- **When 12-Lead Analysis is not Available**

If 12-Lead Analysis is not available on your system, the 3 x 4 Cabrera Hybrid format prints the 12-lead ECG data in four non-staggered 2.5 second segments. An additional Staggered icon () is available that allows you to print the ECG data in four staggered 2.5 second segments if desired.

## Printing 10 Seconds of Waveform Traces

The Print 10s Trace 1, Print 10s Trace 2 and Print 10s Trace 3 options allow you to choose to have 10 seconds of up to 3 additional waveform traces print at the end of the 12-Lead report.

## Specifying the 12-Lead Frequency Response

This option allows you to specify the frequency response of the 12-lead waveform display.

You can specify the following trace display ranges:

Display Type	Frequency Response
Diagnostic	0.525 to 150 Hz
Filtered Diagnostic	0.525 to 40 Hz

**Note:** The display and the recording present the waveform according to the filter setting (Diagnostic or Filtered Diagnostic), but the 12-Lead Interpretive Analysis is always performed using a diagnostic bandwidth that follows the unit's AC Mains filter setting.

## Enabling 12-Lead Analysis

This option allows you to enable or disable 12 Lead Analysis. The default is enabled (**On**).

## Enabling Interpretive Text

The option allows you to choose whether or not to have 12-Lead interpretive statements display on 12-Lead Interpretive Analysis reports (both on screen and on printouts). When this parameter is set to On and 12-Lead Interpretive Analysis is enabled, the ECG analysis measurements along with interpretation statements display on the 12-Lead Interpretive Analysis report. When this parameter is set to Off only the measurements display without any interpretation statements. The default is **On**. The setting you choose here persists through all cases and device updates.

# Chapter 15

## Manual Defibrillation

---



Paddles are a defibrillation-protected Type BF patient connection.



ECG leads are a defibrillation-protected Type CF patient connection.

### Emergency Defibrillation Procedure with Paddles

---

**Warning!** To avoid risk of electrical shock, do not allow electrolyte gel to accumulate on hands or paddle handles.

When defibrillating with paddles, use your thumbs to operate the **SHOCK** buttons in order to avoid inadvertent operator shock. No portion of the hands should be near the paddle plates.

Be sure to use the proper paddles/electrodes based on the size of the patient (adult - large, pediatric - small).

---

## Determine the Patient's Condition Following Local Medical Protocols

Verify the following:

- Unconsciousness
- Absence of breathing
- Absence of pulse

## Begin CPR Following Local Medical Protocols

Request additional assistance.

## Turn On Unit

Press the green power switch located on the top of the unit. The green, yellow, and red lights at the top of the unit flash on and off, and the unit displays the message *SELF TEST PASSED*.

## 1 Select Energy Level

Press the **Energy Select** arrows up or down to select the desired energy level. These buttons are located either on the front of the unit or on the STERNUM paddle.

**Note:** The initial defibrillator pad/external paddle energy selection can be set in Defib/Pacer default settings in the Setup>Supervisor menu. The energy selections listed for Shock 1, Shock 2, and Shock 3 are used only when Basic Auto Energy Escalation is enabled. Otherwise, the values set in Defib/Pacer > Default Settings are used.

The default energy selections for adult patients are:

Shock 1 - 120 joules

Shock 2 - 150 joules

Shock 3 - 200 joules

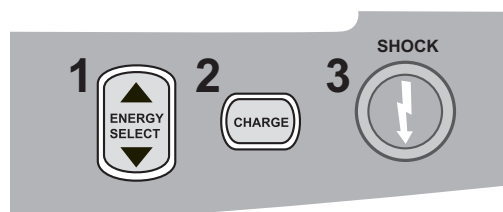
The default energy selections for pediatric patients are:

Shock 1 - 50 joules

Shock 2 - 70 joules

Shock 3 - 85 joules

**Note:** Neonatal and pediatric defibrillator energy levels should be selected based on site-specific protocols.



or



The selected energy level is displayed at the bottom of the display screen.

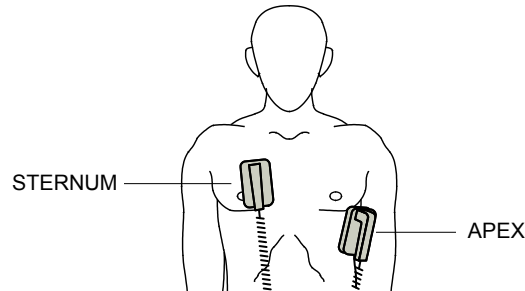
## Prepare Paddles

Ensure that the paddles are connected to the multi-function (MFC) or OneStep cable, and that the cable is connected to the X Series unit. Apply a liberal amount of electrolyte gel to the electrode surface of each paddle, and rub the electrode surfaces together to evenly distribute the applied gel. (You can substitute electrode gel patches for the gel.)

### Apply Paddles to Chest

Apply the paddles firmly to the anterior wall of the chest. Place the STERNUM paddle to the right of the patient's STERNUM (patient's right), just below the clavicle.

Place the APEX paddle on the chest wall, just below and to the left of the patient's left nipple, along the anterior-axillary line.



Rub the paddles against the skin to maximize the paddle-to-patient contact.

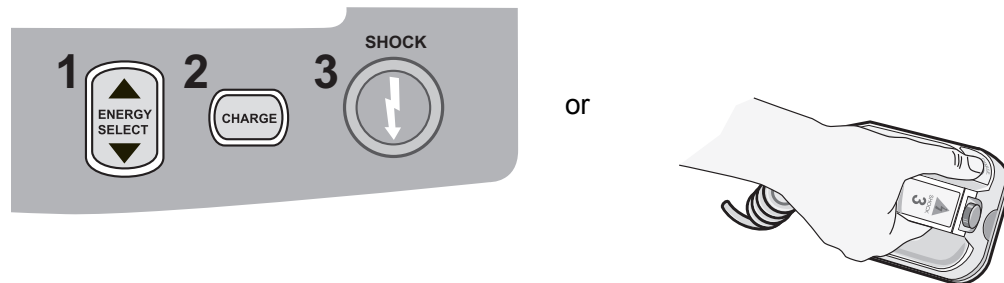
**Warning!** Do not permit gel to accumulate between the paddle electrodes on the chest wall (gel bridge). This could cause burns and reduce the amount of energy delivered to the heart.

If using defibrillator gel pads, make sure that the size of the pad is large enough to cover the entire paddle electrode area.

The paddles may be used for ECG monitoring in emergency situations when time does not allow connection of standard ECG monitoring electrodes.

## 2 Charge Defibrillator

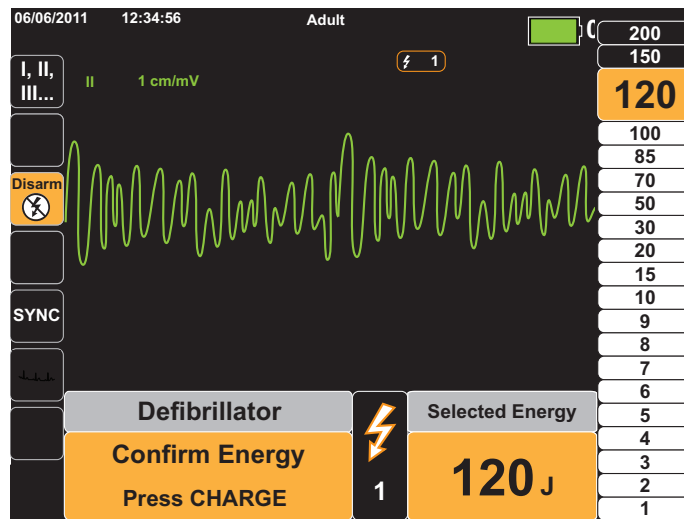
Press the **CHARGE** button on the APEX handle or on the front panel.



To increase or decrease the selected energy after you have pressed the **CHARGE** button, use the defibrillator **ENERGY SELECT** buttons on either the STERNUM paddle or the defibrillator front panel.

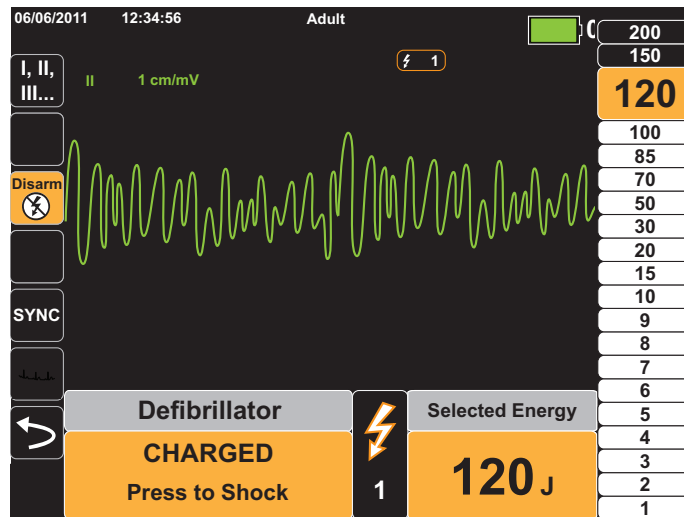
**Caution** Changing the selected energy while the unit is charging or charged causes the defibrillator to disarm itself. Press the **CHARGE** button again to charge the unit to the newly selected energy level.

Press the **CHARGE** button again to confirm the charge.



A charging message displays at the bottom of the screen, and a distinctive charging tone sounds indicating that the unit is charging.

The energy range bar graph on the right side of the display highlights the charge level until it reaches the selected energy. When the unit is fully charged, the tone changes to a continuous charge ready tone, the highlighted energy bar graph includes the selected energy, and the charge indicator on the APEX paddle lights up.





---

## 3 Deliver Shock

---

**Warning!** Warn all persons in attendance of the patient to **STAND CLEAR** prior to defibrillator discharge.

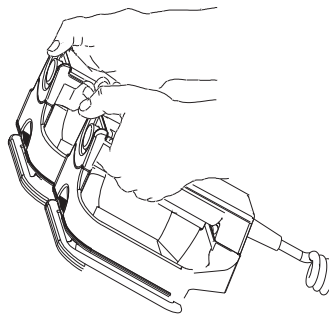
**Do not touch the bed, patient, or any equipment connected to the patient during defibrillation. A severe shock can result. Do not allow exposed portions of the patient's body to come into contact with metal objects, such as a bed frame, as unwanted pathways for defibrillation current may result.**

---

Apply a force of 10 - 12 kilograms (22 - 26.4 pounds) to each paddle in order to minimize patient impedance and achieve optimal results.

Using your thumbs, simultaneously press and hold both **SHOCK** buttons (one on each paddle) until energy is delivered to the patient.

**Note:** The front panel **SHOCK** button (ⓘ) is inactive when using external paddles. Pressing this button instead of the paddle **SHOCK** buttons will produce an audible invalid operation tone.



The delivered energy level is displayed at the bottom of the screen and the shock number (1) displays at the top of the screen and in the Defib Control panel at the bottom of the screen.



**Note:** If at any time you want to cancel the defibrillation, press the **Disarm** quick access key.

If the defibrillator is not discharged within 60 seconds after reaching the selected energy level, the unit automatically disarms itself.

If additional countershocks are needed, follow steps 1 through 3 of this procedure starting on page 15-2, to readjust the energy settings, charge the unit, and deliver the shock.

## Emergency Defibrillation Procedure with Hands-Free Therapy Electrodes



ZOLL hands-free therapy electrodes are a defibrillation-protected Type BF patient connection.



ECG leads are a defibrillation-protected Type CF patient connection.

### Determine the Patient's Condition Following Local Medical Protocols

Verify:

- Unconsciousness
- Absence of breathing
- Absence of pulse

### Begin CPR Following Medical Protocols

Request additional assistance.

### Prepare Patient

Remove all clothing covering the patient's chest. Dry chest if necessary. If the patient has excessive chest hair, clip or shave it to ensure proper adhesion of the electrodes.

Attach hands-free therapy electrodes according to instructions on the electrode packaging.

Ensure that the therapy electrodes are making good contact with the patient's skin and are not covering any part of the ECG electrodes.

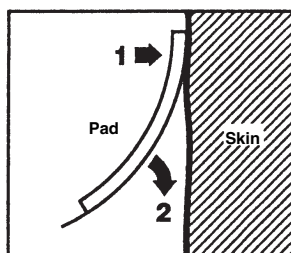
### Therapy Electrode Application

---

**Warning!** Poor adherence and/or air under the therapy electrodes can lead to the possibility of arcing and skin burns.

---

1. Apply one edge of the pad securely to the patient.
2. Roll the pad smoothly from the applied edge to the other, being careful not to trap any air pockets between the gel and skin.



**Note:** If it is not possible to place the "BACK" electrode on the patient's back, place the electrodes in the standard apex-sternum positions. Effective defibrillation results, but pacing will usually be less effective.

## Turn On Unit

Press the green power switch located on the top of the unit. The green, yellow, and red lights at the top of the unit flash on and off, and the unit displays the message *SELF TEST PASSED*.

If defibrillation electrodes are not making good contact with the patient's skin and the lead selection is ECG Lead, the unit issues the message *CHECK THERAPY ELECTRODES* and does not allow the delivery of energy.

## 1 Select Energy Level

Press the **Energy Select** arrows up or down to select the desired energy level. These buttons are located on the front panel of the unit.

**Note:** The initial defibrillator pad/external paddle energy selection can be set in Defib/Pacer default settings in the Setup>Supervisor menu. The energy selections listed for Shock 1, Shock 2, and Shock 3 are used only when Basic Auto Energy Escalation is enabled. Otherwise, the values set in Defib/Pacer > Default Settings are used.

The default energy selections for adult patients are:

Shock 1 - 120 joules

Shock 2 - 150 joules

Shock 3 - 200 joules

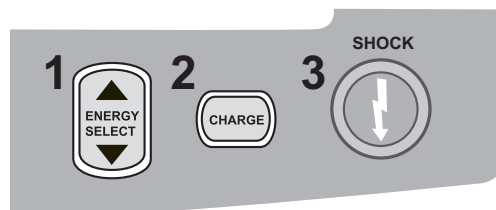
The default energy selections for pediatric patients are:

Shock 1 - 50 joules

Shock 2 - 70 joules

Shock 3 - 85 joules

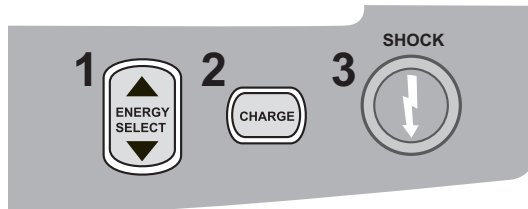
**Note:** Neonatal and pediatric defibrillator energy levels should be selected based on site-specific protocols.



The selected energy level is shown on the display.

## 2 Charge Defibrillator

Press the **CHARGE** button on the front panel.



To increase or decrease the selected energy after you have pressed the **CHARGE** button, use the defibrillator **Energy Select** arrows on the front panel.

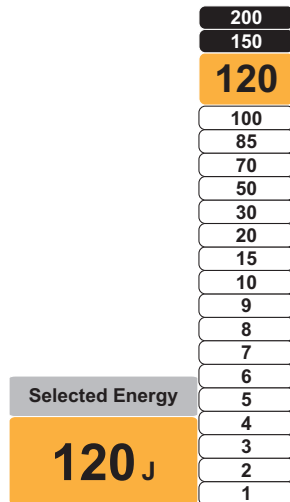
---

**Caution** Changing the selected energy while the unit is charging or charged causes the defibrillator to disarm itself. Press the **CHARGE** button again to charge the unit to the newly selected energy level.

---

A charging message displays at the bottom of the screen, and a distinctive charging tone sounds indicating that the unit is charging.


The energy range bar graph on the right side of the display highlights the charge level until it reaches the selected energy. When the unit is fully charged, the tone changes to a continuous charge ready tone, the highlighted energy bar graph includes the selected energy, and the **SHOCK** button lights up.

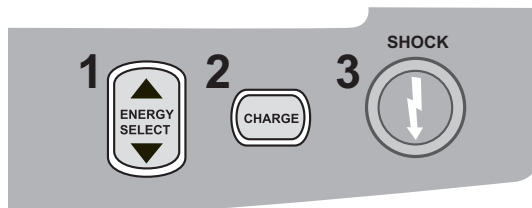


### 3 Deliver Shock

**Warning!** Warn all persons in attendance of the patient to **STAND CLEAR** prior to defibrillator discharge.

**Do not touch the bed, patient, or any equipment connected to the patient during defibrillation. A severe shock can result. Do not allow exposed portions of the patient's body to come into contact with metal objects, such as a bed frame, as unwanted pathways for defibrillation current may result.**

Press and hold the  button on the front panel until energy is delivered to the patient.



The delivered energy level is displayed at the bottom of the screen and the shock number (1) displays at the top of the screen and in the Defib Control panel at the bottom of the screen.



**Note:** If at any time you want to cancel the defibrillation, press the **Disarm** softkey.

If the defibrillator is not discharged within 60 seconds after reaching the selected energy level, the unit automatically disarms itself.

If additional countershocks are needed, follow steps 1 through 3 of this procedure starting on page 15-7, to readjust the energy settings, charge the unit, and deliver shock.

## Internal Paddles

ZOLL internal paddles are designed for use with the ZOLL X Series defibrillator to defibrillate the heart during open chest procedures. Two types of Autoclavable Internal Handles are available:

- Molded Autoclavable Internal Handles with integrated electrodes
- Autoclavable Internal Handles with removable internal defibrillation electrodes

When an internal handle set is connected to the X Series, it automatically limits defibrillator energy output to a maximum of 50 joules.

For step-by-step procedures for open chest defibrillation as well as important cleaning and sterilization information regarding the autoclavable electrodes, refer to the *Autoclavable Internal Handle and Electrode Operator's Guide*.



## Verification Prior to Use

Before each use with the X Series, verify the proper operation of the ZOLL internal paddles using the following procedure. This procedure requires a second person if you are using internal handles without a Discharge button.

---

**Warning!**    **When performing internal paddle verification, keep hands away from the electrode plates while pressing the SHOCK button.**

---

1. Inspect the connector contact sockets for damage or corrosion. If you observe damage or corrosion in the connector contact sockets, remove the handle set from use.
2. Connect the Autoclavable Internal Handles to the X Series unit. Use the Lead quick access key  to verify that the X Series unit correctly identifies the Internal Handle and Electrode set by displaying **Int. Pds.**
3. Before charging the defibrillator, press the **Discharge** button on the handle set (if present) and verify that there is an audible click and that the button springs back upon release. Verify that the defibrillator window displays the message *APPLY PADDLES TO PATIENT*. This message verifies that the **Discharge** button located on the right handle is operating correctly.
4. Press the Energy Select arrows (located on the front panel of the X Series unit) up or down to select 30 Joules.
5. Press the **CHARGE** button on the defibrillator front panel to charge the unit to the selected energy level. Wait for the READY tone.
6. Press the electrode plate surfaces firmly together and away from any person or object.
7. Discharge the energy in the following manner.
  - For internal handles with a Discharge button:  
Press and hold the **Discharge** button on the apex handle to deliver the test energy to the electrodes.
  - For internal handles without a Discharge button:  
Have a second person press and hold  on the defibrillator front panel to deliver the test energy to the electrodes.

The X Series device unit discharges and displays the message *DEFIB SHORT TEST PASSED*.

---

# Synchronized Cardioversion

---

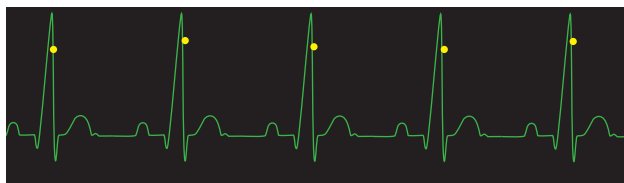
**Warning!** Only skilled personnel trained in Advanced Cardiac Life Support and familiar with equipment operation should perform synchronized cardioversion. The precise cardiac arrhythmia must be determined before attempting defibrillation or cardioversion.

**Before attempting synchronized cardioversion, ensure that ECG signal quality is sufficient to minimize the risk of synchronizing on artifact.**

---

Certain arrhythmias, such as ventricular tachycardia, atrial fibrillation, and atrial flutter, require synchronizing the defibrillator discharge with the ECG R-wave to avoid the induction of ventricular fibrillation. In this case, a synchronizing (SYNC) circuit within the defibrillator detects the patient's R-waves. When the **SHOCK** button (or buttons, if using paddles) is pressed and held, the unit discharges with the next detected R-wave, thus avoiding the vulnerable T-wave segment of the cardiac cycle.

When in the SYNC mode, the unit displays markers (**S**) above the ECG trace to indicate the points in the cardiac cycle (R waves) where discharge can occur.



S marker indicates each detected R wave during synchronization.

Verify that markers are clearly visible on the monitor and their location is appropriate and consistent from beat to beat.

The synchronized cardioversion procedure for ZOLL hands-free therapy electrodes is identical to that for paddles with the exception of the **SHOCK** button location.

# Synchronized Cardioversion Procedure

## Determine the Patient's Condition and Provide Care Following Local Medical Protocols

### Prepare Patient

Remove all clothing covering the patient's chest. Dry chest if necessary. If the patient has excessive chest hair, clip or shave it to ensure proper adhesion of the electrodes.

Attach ECG electrodes (see Chapter 6 for instructions on attaching ECG electrodes to the patient).

A standard ECG cable and ECG electrodes are recommended for use during cardioversion. Hands-free therapy electrodes may be used as an ECG source. Signal quality will be equal to that of standard leads except immediately following a discharge when there may be more noise due to muscle tremors, especially if an electrode is not in complete contact with the skin.

Attach hands-free therapy electrodes according to instructions on the electrode packaging and as described in "Therapy Electrode Application" on page 15-6.

Ensure that the therapy electrodes are making good contact with the patient's skin and are not covering any part of any other electrodes.

If paddles are being used for synchronized cardioversion, refer to "Emergency Defibrillation Procedure with Paddles" on page 15-1 for preparing paddles, applying paddles, charging the defibrillator, and delivering a shock. Note, however, that synchronized discharge with paddles as an ECG source is discouraged since the artifact induced by moving the paddles may resemble an R-wave and trigger defibrillator discharge at the wrong time.

### Turn On Unit

Press the green power switch located on the top of the unit. The green, yellow, and red lights at the top of the unit flash on and off, and the unit displays the message *SELF TEST PASSED*.

### Press the Sync Key

Press the **Sync** quick access key on the front panel. The system will now be in SYNC mode. A sync marker (**S**) appears on the monitor above each detected R-wave to indicate where discharge will occur. A Sync indicator appears at the top of the display screen, and a green light next to the indicator flashes with each Sync marker.



**Note:** If the marker does not appear over the R wave, select a different ECG lead. If the sync marker doesn't display, the defibrillator will not discharge.

Unless otherwise configured, the unit automatically exits Sync mode after each shock. To reactivate SYNC mode, press the **Sync** quick access key on the front panel again. Changing the selected energy levels does not cause the unit to leave SYNC mode.

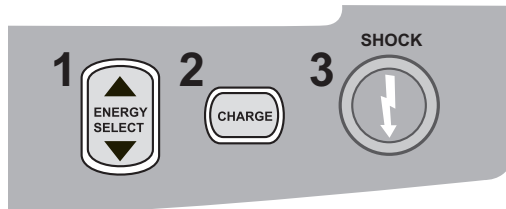
**Note:** The unit can be configured to stay in SYNC mode after defibrillation in Defib/Pacer default settings in the Setup>Supervisor menu.



## 1 Select Energy Level

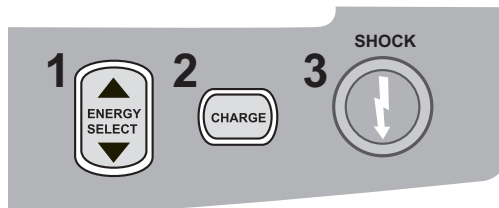
Press the **Energy Select** arrows up or down to select the desired energy level. These buttons are located either on the front of the unit or on the STERNUM paddle.

**Warning!** When using pediatric defibrillation electrodes, defibrillator energies must be set manually based on site-specific institutional protocols for pediatric defibrillation.



## 2 Charge Defibrillator

Press the **CHARGE** button on the front panel or on the APEX paddle handle.



or



To increase or decrease the selected energy after you have pressed the **CHARGE** button, use the defibrillator **Energy Select** arrows on the front panel or sternum panel.

**Caution** Changing the selected energy while the unit is charging or charged causes the defibrillator to disarm itself. Press the **CHARGE** button again to charge the unit to the newly selected energy level.

A charging message displays at the bottom of the screen, and a distinctive charging tone sounds indicating that the unit is charging.

The energy range bar graph on the right side of the display highlights the charging progress until it reaches the selected energy. When the unit is fully charged, the tone changes to a continuous charge ready tone, the highlighted energy bar graph includes the selected energy, and the SHOCK button lights up.

### 3 Deliver Shock

---

**Warning!** Warn all persons in attendance of the patient to *STAND CLEAR* prior to defibrillator discharge.

Verify that no one is in contact with the patient, monitoring cable or leads, bed rails, or any other potential current pathways.

---

Verify that the ECG waveform is stable and that sync markers appear over each R-wave.

Press and hold the illuminated **SHOCK** button on the front panel, (or simultaneously press and hold both paddle **SHOCK** buttons) until energy is delivered to the patient. The defibrillator will discharge with the next detected R wave.

The delivered energy level is displayed at the bottom of the screen and the shock number (1) displays at the top of the screen.

**Note:** If at any time you want to cancel the defibrillation, press the **Disarm** quick access key.

If the defibrillator is not discharged within 60 seconds after reaching the selected energy level, the unit automatically disarms itself.

If additional countershocks are needed (and the **Sync after Cardioversion** setting is disabled), press the **Sync** quick access key again and follow steps 1 through 3 of this procedure starting on page 15-13, to readjust the energy settings, charge the unit, and deliver shock.

You can configure the **Sync after Cardioversion** setting through the Setup>Supervisor>Defib/Pacer>Default Settings menu.

# Chapter 16

## Advisory Defibrillation

---



ZOLL hands-free therapy electrodes are a defibrillation-protected Type BF patient connection.

When the X Series unit is configured for Advisory (or single analysis) defibrillation, the X Series unit can identify shockable rhythms using its built in ECG analysis capability. You must read the advisory messages, charge the defibrillator to the preconfigured or user-selected energy level (if automatic charge is disabled), and deliver treatment to the patient when required by protocol and patient condition.

The advisory function can be activated only when:

- The unit is configured for Single Analysis.
- The unit is on and in manual mode.
- Hands-free therapy electrodes are properly connected to the patient.
- Valid impedance is detected and pacer is off.
- Patient mode is not set to neonate.

---

**WARNING!** Use only pediatric electrodes to defibrillate patients under 8 years of age in Advisory mode, and make sure the patient mode is set to pediatric. Use of adult electrodes or adult mode with pediatric patients can result in the delivery of excessive energy doses.

---

## Advisory Defibrillation Procedure

### Determine the Patient's Condition Following Local Medical Protocols

Verify:

- Unconsciousness.
- Absence of breathing.
- Absence of pulse.

### Begin CPR Following Local Medical Protocols

Request additional assistance.

### Prepare Patient

Remove all clothing covering the patient's chest. Dry chest if necessary. If the patient has excessive chest hair, clip or shave it to ensure proper adhesion of the electrodes.

Attach hands-free therapy electrodes according to instructions on the electrode packaging and as described in "Therapy Electrode Application" on page 15-6.

Ensure that the electrodes are making good contact with the patient's skin and are not covering any part of the ECG electrodes.

If therapy electrodes are not making good contact with the patient's skin, the unit issues the message *CHECK PADS* and does not allow delivery of energy.

**Note:** Since analysis is only done using Pads as a lead, even if an ECG cable is connected and Lead II is available, the unit still displays a *CHECK PADS* message.

---

## 1 Turn on unit

Press the green power switch located on the top of the unit. The green, yellow, and red lights on the top of the unit flash on and off, and the unit displays the message SELF TEST PASSED.

### If Unit is in AED Mode

1. Press the **Manual Mode** quick access key on the front panel of the unit to enter the Manual mode of operation.
2. Using the navigation keys, select the four digits in the Manual Mode pass code. Press **SAVE** when you are finished. Once you have entered your pass code, you will be able to enter Manual mode.

**Note:** If the unit has been not been configured to enter a pass code, the message *Exit to Manual Mode* is displayed. Use the navigation keys to select **Yes** to enter the Manual mode of operation. If you do not press **Yes** within 10 seconds, the unit will revert back to AED operation.

**If Unit is in Manual Mode** – No additional steps are necessary to proceed.

If no hands-free therapy electrodes have been attached to the patient and connected to the X Series unit, the *ATTACH PADS* message and voice prompt will be issued.

### Energy Select

The default energy selections for adult patients are:

Shock 1 - 120 joules

Shock 2 - 150 joules

Shock 3 - 200 joules

The default energy selections for pediatric patients are:

Shock 1 - 50 joules

Shock 2 - 70 joules

Shock 3 - 85 joules

**Note:** Pediatric defibrillator energy levels should be selected based on site specific protocols.

---

**WARNING!** Use only pediatric electrodes to defibrillate patients under 8 years of age in Advisory mode, and make sure the patient mode is set to pediatric. Use of adult electrodes or adult mode with pediatric patients can result in the delivery of excessive energy doses.

---

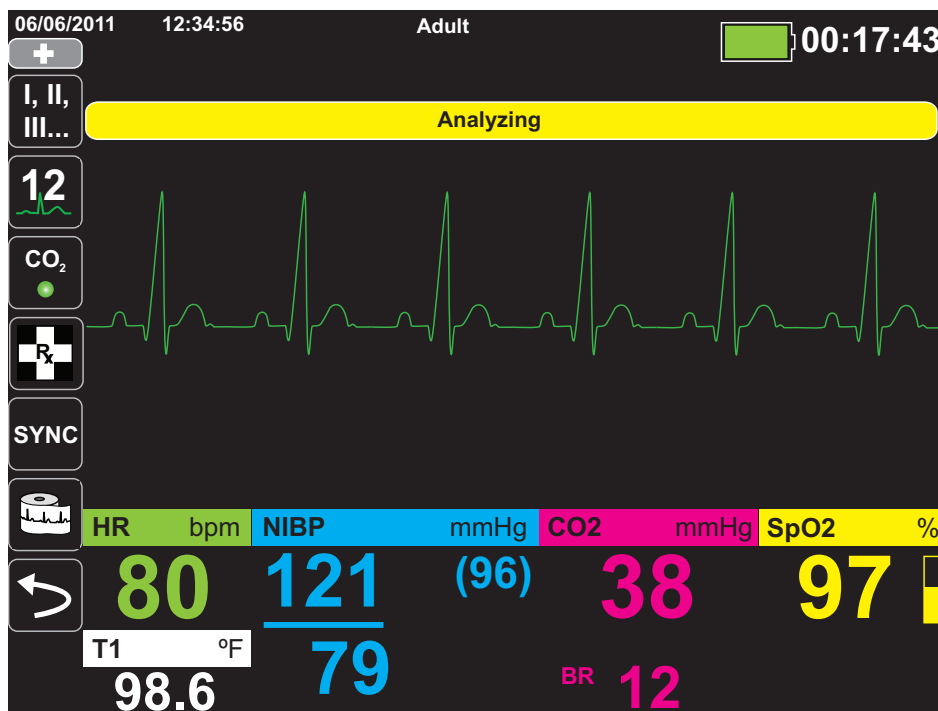
If medical protocols allow, you may select a different energy level using the energy select up and down arrow buttons on the front panel. The new energy setting displays on the monitor.

## 2 Press ANALYZE Button

**WARNING!** Keep patient motionless during ECG analysis. Do not touch the patient during analysis. Cease all movement via stretcher or vehicle before analyzing the ECG.

Press the **ANALYZE** button to begin the analysis of the patient's ECG rhythm and to determine if a shockable rhythm is present.

An *ANALYZING* message is displayed at the top of the screen for 6 to 12 seconds while the patient's ECG is analyzed. Once the analysis is completed, the unit indicates whether or not a shock is advised.



The analysis determines whether there is a shockable rhythm. If the analysis detects a shockable rhythm, the unit prompts the operator to shock the patient at the preconfigured energy level. If the analysis does not detect a shockable rhythm, the unit alerts the operator that no shock is advised.

**WARNING!** ECG rhythm analysis does not warn of patient asystole, which is not a shockable rhythm.

When a nonshockable rhythm is detected, the unit displays a *NO SHOCK ADVISED* message. Follow the local protocols to continue CPR or other life support, and re-analyze the ECG at appropriate intervals.

**Note:** When a nonshockable rhythm is detected, the X Series does not prevent the user from manually defibrillating the patient.

When a shockable rhythm is detected (ventricular fibrillation or wide-complex tachycardia with heart rate > 150), the unit will display the *SHOCK ADVISED* message. Press the


**CHARGE** button, and press the **Select Energy** arrows up or down to select the desired energy level if needed. Press **CHARGE** again to confirm.

Regardless of the analysis result, the user can control the defibrillator manually. For example, the user can defibrillate the patient even if the advisory function issues a *NO SHOCK ADVISED* message.

### 3 Press SHOCK button

**WARNING!** Warn all persons in attendance of the patient to **STAND CLEAR** prior to defibrillator discharge.

**Do not touch the bed, patient, or any equipment connected to the patient during defibrillation. A severe shock can result. Do not allow exposed portions of the patient's body to come in contact with metal objects, such as a bed frame, as unwanted pathways for defibrillation current may result.**

Press and hold the **SHOCK** button  on the front panel until energy is delivered to the patient.

The delivered energy level is displayed at the bottom of the screen and the shock number (1) displays at the top of the screen and in the Defib Control panel at the bottom of the screen.



**Note:** If at any time you want to cancel the defibrillation, press the **Disarm** softkey.

If the defibrillator is not discharged within 60 seconds after reaching the selected energy level, the unit automatically disarms itself.

If additional countershocks are needed, follow steps 1 through 3 of this procedure starting on page 16-3, to readjust the energy settings, charge the unit, and deliver shock.

#### Perform CPR

Begin chest compressions and rescue breathing per local protocol.

#### Repeat Analysis

Press the **ANALYZE** button to restart an ECG analysis and determine if additional shocks are required.

**Note:** Reanalysis of the ECG rhythm is inhibited for 3 seconds after each shock.

#### Continue Patient Care

Continue patient care according to medical protocols.





# Chapter 17

## Analysis/CPR Protocol Defibrillation

---



ZOLL hands-free therapy electrodes are a defibrillation-protected Type BF patient connection.

When the X Series unit is configured for Analysis/CPR Protocol defibrillation, the unit guides you through a cardiac event by performing ECG analysis, preparing the device for a shock (if needed), and leading you through a CPR interval. This cycle is repeated as long as Analysis/CPR Protocol is active and pads are attached to the patient. If pads become detached from the patient or shorted during rescue protocol, the protocol halts until the pads are reattached or continues through the CPR interval and then halts and waits for the pads to be reattached.

If you press the Energy Select Up/Down arrow keys or **CHARGE** button while in Analysis/CPR Protocol mode, the unit transitions to Manual mode. If the unit is charged when you transition from Analysis/CPR Protocol to Manual mode, the unit disarms and halts any analysis that is taking place.

The Analysis/CPR Protocol function can be activated only when:

- The unit is configured for Analysis/CPR Protocol.
- The unit is on and in manual mode.
- Hands-free therapy electrodes are properly connected to the patient.
- Valid impedance is detected and pacemaker is off.
- Patient mode is not set to neonate.

**WARNING!** Use only pediatric electrodes to defibrillate patients under 8 years of age in Analysis/CPR Protocol mode, and make sure the patient mode is set to pediatric. Use of adult electrodes or adult mode with pediatric patients can result in the delivery of excessive energy doses.

---

## Analysis/CPR Protocol Defibrillation Procedure

### Determine the Patient's Condition Following Local Medical Protocols

Verify:

- Unconsciousness.
- Absence of breathing.
- Absence of pulse.

### Begin CPR Following Local Medical Protocols

Request additional assistance.

### Prepare Patient

Remove all clothing covering the patient's chest. Dry chest if necessary. If the patient has excessive chest hair, clip or shave it to ensure proper adhesion of the electrodes.

Attach hands-free therapy electrodes according to instructions on the electrode packaging and as described in "Therapy Electrode Application" on page 15-6.

Ensure that the electrodes are making good contact with the patient's skin and are not covering any part of the ECG electrodes.

If therapy electrodes are not making good contact with the patient's skin, the unit issues the message *CHECK PADS* and does not allow delivery of energy.

## 1 Turn on unit

Press the green power switch located on the top of the unit. The green, yellow, and red lights on the top of the unit flash on and off, and the unit displays the message *SELF TEST PASSED*.

### If Unit is in AED Mode

1. Press the **Manual Mode** quick access key on the front panel of the unit to enter the Manual mode of operation.
2. Using the navigation keys, select the four digits in the Manual Mode pass code. Press **SAVE** when you are finished. Once you have entered your pass code, you will be able to enter Manual mode.

**Note:** If the unit has been not been configured to enter a pass code, the message *Exit to Manual Mode* is displayed. Use the navigation keys to select **Yes** to enter the Manual mode of operation. If you do not press **Yes** within 10 seconds, the unit will revert back to AED operation.

**If Unit is in Manual Mode** – No additional steps are necessary to proceed.

If no hands-free therapy electrodes have been attached to the patient and connected to the X Series unit, the *ATTACH PADS* message and voice prompt will be issued.

### Energy Select

The default energy selections for adult patients are:

Shock 1 - 120 joules

Shock 2 - 150 joules

Shock 3 - 200 joules

The default energy selections for pediatric patients are:

Shock 1 - 50 joules

Shock 2 - 70 joules

Shock 3 - 85 joules

**Note:** Pediatric defibrillator energy levels should be selected based on site specific protocols.

---

**WARNING!** Use only pediatric electrodes to defibrillate patients under 8 years of age in Analysis/CPR Protocol mode, and make sure the patient mode is set to pediatric. Use of adult electrodes or adult mode with pediatric patients can result in the delivery of excessive energy doses.

---

## 2 Press ANALYZE Button

**WARNING!** Keep patient motionless during ECG analysis. Do not touch the patient during analysis. Cease all movement via stretcher or vehicle before analyzing the ECG.

Press the **ANALYZE** button to begin the analysis of the patient's ECG rhythm and to determine if a shockable rhythm is present.

The *ANALYZING ECG* and *STAND CLEAR* messages alternate at the bottom of the screen while the patient's ECG is analyzed. Once the analysis is completed, the unit indicates whether or not a shock is advised.

**Note:** You can terminate the Analysis/CPR Protocol mode and return to Manual mode at any time by pressing the **Exit** quick access key.



This analysis normally consists of up to three consecutive 3-second ECG rhythm analyses. If at least two of the three analyses determine that the patient has a shockable rhythm, the unit automatically prompts the operator to shock the patient at the preconfigured energy level. If two or more of the three 3-second ECG analyses do not detect a shockable rhythm, the unit alerts the operator that no shock is advised.

**WARNING!** ECG rhythm analysis does not warn of patient asystole, which is not a shockable rhythm.

When you press the Energy Select Up/Down arrow keys or **CHARGE** button while in Analysis/CPR Protocol mode, the unit transitions to Manual mode. If the unit is charged when you transition from Analysis/CPR Protocol to Manual mode, the unit disarms and halts any analysis that is taking place.

### Non-Shockable Rhythm

When a nonshockable rhythm is detected, the unit displays a *NO SHOCK ADVISED* message. The unit then leads you through a CPR interval and then restarts ECG analysis automatically. The Analysis/CPR Protocol mode repeats the Analysis and CPR intervals as long as Analysis/CPR Protocol is active. You can press the **Exit** quick access key at any time to return to Manual mode.

**Note:** When a nonshockable rhythm is detected, the X Series does not prevent the user from manually defibrillating the patient.

### Shockable Rhythm

If the patient's rhythm is shockable, the unit displays the *SHOCK ADVISED* and *PRESS SHOCK* messages. The defibrillator automatically prompts the operator to shock the patient at the preconfigured energy level and the **SHOCK** button illuminates.

A continuous tone sounds for 20 or 50 seconds (depending on configuration), followed by a higher pitch tone for 10 seconds. You must deliver the shock within this 30 or 60 second interval (depending on configuration), or the defibrillator will disarm itself.

## 3 Press SHOCK button

**WARNING!** Warn all persons in attendance of the patient to **STAND CLEAR** prior to defibrillator discharge.

**Do not touch the bed, patient, or any equipment connected to the patient during defibrillation. A severe shock can result. Do not allow exposed portions of the patient's body to come in contact with metal objects, such as a bed frame, as unwanted pathways for defibrillation current may result.**

Press and hold the illuminated **SHOCK** button  on the front panel until energy is delivered to the patient.

The delivered energy level is displayed at the bottom of the screen and the shock number (1) displays at the top of the screen and in the Defib Control panel at the bottom of the screen.



The unit then leads you through a CPR interval and then restarts ECG analysis automatically. The Analysis/CPR Protocol mode repeats the Analysis and CPR intervals as long as Analysis/CPR Protocol is active. You can press the **Exit** quick access key at any time to return to Manual mode.

## RapidShock

RapidShock analysis algorithm provides ultrafast shock/no-shock decision. RapidShock is available in AED mode only or in both AED and Rescue Protocol modes of operation. For further information and how to enable/disable this feature, consult the *X Series Configuration Manual*.

**Note:** RapidShock is only available in Adult mode and when one of the following electrodes is used: ZOLL OneStep CPR electrodes, OneStep Complete electrodes, CPR-D-padz or CPR Stat-padz.

---

**WARNING!** Performance of the RapidShock Mode has not been demonstrated in patients under 8 years of age or less than 55 lbs (25 kg).

---

## The Shock Conversion Estimator

Shock Conversion Estimator takes the output of the analysis algorithm and performs additional analysis to estimate the probability of whether or not the current ECG can successfully be converted by electrical therapy. If the probability of a successful shock is low, the system will advise against a shock and instead instruct to continue CPR as this may be more beneficial to victim resuscitation efforts.

For more information on enabling/disabling the Shock Conversion Estimator feature, please refer to the *X Series Configuration Manual*.

---

**WARNING!** Performance of the Shock Conversion Estimator has not been demonstrated in patients under 8 years of age or less than 55 lbs (25 kg).

---

# Chapter 18

## External Pacing

---



When ZOLL hands-free therapy electrodes are used, the patient connection is considered to be defibrillation-protected Type BF.



ECG leads are a defibrillation-protected Type CF patient connection.

---

**WARNING!** Pacing is intended for use on adult patients and on adolescent, child, and infant pediatric patients.

To avoid risk of electrical shock, do not touch the gelled area of the hands-free therapy electrodes while pacing.

Therapy electrodes should be replaced periodically. Consult electrode directions for specific recommendations.

Prolonged pacing (in excess of 30 minutes), particularly in adolescent, child, and infant pediatric patients or adults with severely restricted blood flow, may cause burns. Periodic inspection of the underlying skin is recommended.

When pacing in demand mode, the pacer may be adversely affected from EMI, RFI, or ESU. Move patient away from any potential sources of interference.

---

## External Pacing

X Series defibrillators contain a pacemaker for the emergency treatment of hemodynamically compromising bradycardia, bradycardia with escape rhythms that are unresponsive to pharmacological therapy, refractory tachycardia (supraventricular or ventricular) and bradysystolic cardiac arrest.

Proper demand pacing requires a reliable, high quality surface ECG signal. For best results apply both standard ECG monitoring electrodes and hands-free pacing therapy electrodes to the patient.

### Pacer Modes

The X Series has two pacer mode settings: Demand and Fixed. The default factory mode setting is Demand.

In Demand mode, pacing pulses are inhibited by the patient's QRS complexes that occur during an interval that is dependent on the setting of the rate control. If during that interval no QRS complexes are detected, a pacing pulse is delivered to the patient. In the demand mode, the pacer supplies the required number of pacing pulses to maintain the patient's heart rate at approximately the rate selected in the pacing rate window. See the procedure below, "Pacing in Demand Mode" for more information.

In Fixed mode, pacing pulses are not dependent on the patient's cardiac activity. Fixed pacing should be performed only in an emergency when no alternative is available. The pacer delivers pacing pulses at the selected pacing rate. See "Pacing in Fixed Mode" on page 18-6 for more information.

## Pacing in Demand Mode

### Determine Patient Condition and Provide Care Following Local Medical Protocols

#### Prepare the Patient

Remove all clothing covering the patient's chest. Dry chest if necessary. If the patient has excessive chest hair, clip it to ensure proper adhesion of the electrodes.

#### 1 Turn On Unit

Press the green power switch located on the top of the unit. The green, yellow, and red lights at the top of the unit flash on and off, and the unit displays the message SELF TEST PASSED.



## 2 Apply ECG Electrodes/Hands-Free Therapy Electrodes

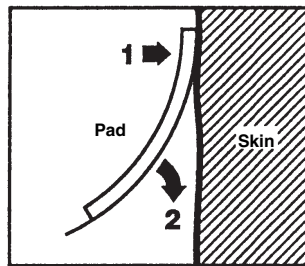
Apply ECG electrodes, attach lead wires, and connect the ECG cable to the X Series side panel (see Chapter 6, "Monitoring ECG" for instructions on attaching ECG electrodes to the patient). Attach hands-free therapy electrodes according to instructions on the electrode packaging. Connect these therapy electrodes to the multifunction cable (MFC).

**Note:** Do not use ZOLL OneStep cables for pacing.

### Therapy Electrode Application

**WARNING!** Poor adherence and/or air under the therapy electrodes can lead to the possibility of arcing and skin burns.

1. Apply one edge of the pad securely to the patient.
2. Roll the pad smoothly from the applied edge to the other, being careful not to trap any air pockets between the gel and skin.



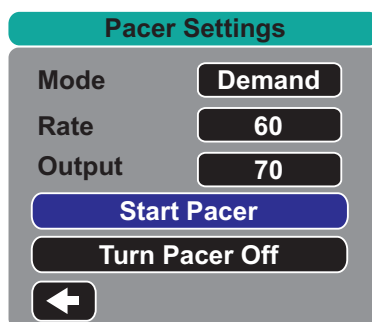
3. Ensure that hands-free therapy electrodes are making good contact with the patient's skin and are not covering any part of any other ECG electrodes.
4. Press the Lead quick access key and select I, II, or III to provide the largest amplitude QRS complex.

**Note:** When the Pacer is on, the lead selection is restricted to Leads I, II, or III.

5. Verify that R-waves are being properly detected by confirming that a QRS tone occurs with each displayed R wave or by verifying that the X Series unit's heart rate display accurately reflects the patient's pulse rate.

## 3 Press PACER button

Press the **PACER** button on the front panel of the unit. The Pacer Settings window displays.



## 4 Set Mode

Use the arrow keys to navigate to Mode, press the Select button, and then use the arrow keys and the Select button to set the Pacer Mode to Demand.

**Note:** The initial pacing mode can be set in Defib/Pacer Default settings in the Supervisor Setup menu.

## 5 Set Pacer Rate

Use the arrow keys to navigate to Rate, press the Select button, and then use the arrow keys and the Select button to set the Pacer Rate to a value 10-20 ppm higher than the patient's intrinsic heart rate. If no intrinsic rate exists, use 100 ppm. You can increase or decrease the pacer rate by a value of 5 ppm for rates below 100, and by 10 ppm for rates above 100.

**Note:** The initial pacing rate can be set in Defib/Pacer Default settings in the Supervisor Setup menu.

## 6 Turn On Pacer

Use the arrow keys to navigate to Start Pacer, then press the Select button to select it. The Pacing window displays behind the Pacer Settings window.

● PACING		
Rate	Output	Mode
80 ppm	95 mA	Demand

## 7 Set Pacer Output

In the Pacer Settings window, use the arrow keys and the Select button to adjust the pacer output. The pacer output is adjustable in 10 mA increments when increasing the output, and in 5 mA increments when decreasing the output. Observe the ECG for evidence of electrical capture. Select the lowest output current that achieves both electrical and mechanical capture.

**Note:** If the Pacer Settings window disappears before you have set the output current, press the **PACER** button again to display the settings window.

## 8 Determine Capture

It is important to recognize when pacing stimulation has produced a ventricular response (capture). Determination of capture must be assessed both electrically and mechanically in order to ensure appropriate circulatory support of the patient.

Electrical capture is determined by the presence of a widened QRS complex, the loss of any underlying intrinsic rhythm, and the appearance of an extended, and sometimes enlarged, T-wave.

Ventricular response is normally characterized by suppression of the intrinsic QRS complex.

---

**WARNING!** **Determination of electrical capture should only be performed by viewing the ECG trace on the X Series display with its ECG connection directly attached to the patient. Use of other ECG monitoring devices might provide misleading information due to the presence of pacemaker artifacts.**

---

Mechanical capture is assessed by palpation of the peripheral pulse.

To avoid mistaking muscular response to pacing stimuli for arterial pulsations, use **ONLY** the following locations for palpating pulse during pacing:

- femoral artery
- right brachial or radial artery

### Effective pacing

Changing ECG leads and size can sometimes be helpful in determining capture.

**Note:** The shape and size of the paced ECG waveforms can vary depending on the ECG lead configuration chosen; variation from patient to patient can be expected.

## 9 Determine Optimum Threshold

The ideal pacemaker current is the lowest value that maintains capture — it is usually about 10% above threshold. Typical threshold currents range from 40 to 80 mA. Location of the hands-free or therapy electrodes affects the current required to obtain ventricular capture. Typically the lowest threshold is obtained when the position of the electrodes provides the most direct current pathway through the heart while avoiding large chest muscles. Lower stimulation currents produce less skeletal muscle contraction and are better tolerated.

## Pacing in Fixed Mode

If ECG electrodes are not available or there is some circumstance that prevents or interferes with the surface ECG, the X Series delivers pacemaker pulses at a fixed rate.

Fixed pacing should be performed only in an emergency when no alternative is available.

### 1 Turn On Unit

Press the green power switch located on the top of the unit. The green, yellow, and red lights at the top of the unit flash on and off, and the unit displays the message SELF TEST PASSED.

### 2 Apply ECG Electrodes/Hands-Free Therapy Electrodes

Apply ECG electrodes, attach lead wires, and connect the ECG cable to the X Series side panel (see Chapter 6 for instructions on attaching ECG electrodes to the patient). Attach hands-free therapy electrodes according to instructions on the electrode packaging. Connect these therapy electrodes to the MFC.

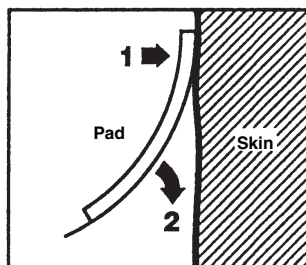
#### Therapy Electrode Application

---

**WARNING!** Poor adherence and/or air under the therapy electrodes can lead to the possibility of arcing and skin burns.

---

1. Apply one edge of the pad securely to the patient.
2. Roll the pad smoothly from the applied edge to the other, being careful not to trap any air pockets between the gel and skin.



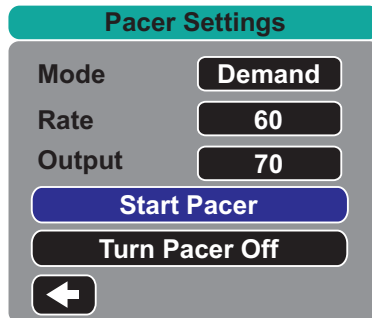
3. Ensure that hands-free therapy electrodes are making good contact with the patient's skin and are not covering any part of any other ECG electrodes.
4. Press the Lead quick access key and select I, II, or III to provide the largest amplitude QRS complex.

**Note:** When the Pacer is on, the lead selection is restricted to Leads I, II, or III.

5. Verify that R-waves are being properly detected by confirming that a QRS tone occurs with each displayed R wave or by verifying that the X Series unit's heart rate display accurately reflects the patient's pulse rate.

### 3 Press PACER button

Press the PACER button on the front panel of the unit. The Pacer Settings window displays.



### 4 Set Mode

Use the arrow keys to navigate to Mode, press the Select button, then use the arrow keys and Select button to set the Pacer Mode to Fixed. The selected mode is displayed in the pacing window.

**Note:** The initial pacing mode can be set in Defib/Pacer Default settings in the Supervisor Setup menu.

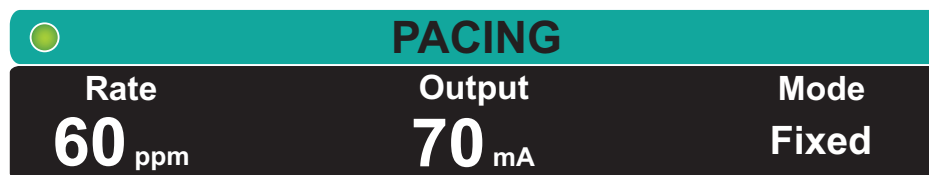
### 5 Set Pacer Rate

Use the arrow keys to navigate to Rate, press the Select button, then use the arrow keys and the Select button to set the Pacer Rate to a value 10-20 ppm higher than the patient's intrinsic heart rate. If no intrinsic rate exists, use 100 ppm. You can increase or decrease the pacer rate by a value of 5 ppm for rates below 100, and by 10 ppm for rates above 100.

**Note:** The initial pacing rate can be set in Defib/Pacer Default settings in the Supervisor Setup menu.

### 6 Turn On Pacer

Use the arrow keys to navigate to Start Pacer, and press the Select button to select it. The Pacing window displays behind the Pacer Settings window.



## 7 Set Pacer Output

In the Pacer Settings window, use the arrow keys and the Select button to adjust the pacer output. The pacer output is adjustable in 10 mA increments when increasing the output, and in 5 mA increments when decreasing the output. Observe the ECG for evidence of electrical capture. Select the lowest output current that achieves both electrical and mechanical capture.

**Note:** If the Pacer Settings window disappears before you have set the output current, press the **PACER** button again to display the settings window.

## 8 Determine Capture

It is important to recognize when pacing stimulation has produced a ventricular response (capture). Determination of capture must be assessed both electrically and mechanically in order to ensure appropriate circulatory support of the patient.

Electrical capture is determined by the presence of a widened QRS complex, the loss of any underlying intrinsic rhythm, and the appearance of an extended, and sometimes enlarged, T-wave.

Ventricular response is normally characterized by suppression of the intrinsic QRS complex.

---

**WARNING!** **Determination of electrical capture should only be performed by viewing the ECG trace on the X Series display with its ECG connection directly attached to the patient. Use of other ECG monitoring devices might provide misleading information due to the presence of pacer artifacts.**

---

Mechanical capture is assessed by palpation of the peripheral pulse.

To avoid mistaking muscular response to pacing stimuli for arterial pulsations, use **ONLY** the following locations for palpating pulse during pacing:

- femoral artery
- right brachial or radial artery

### **Effective pacing**

Changing ECG leads and size can sometimes be helpful in determining capture.

**Note:** The shape and size of the paced ECG waveforms can vary depending on the ECG lead configuration chosen; variation from patient to patient can be expected.

## 9 Determine Optimum Threshold

The ideal pacer current is the lowest value that maintains capture — it is usually about 10% above threshold. Typical threshold currents range from 40 to 80 mA. Location of the hands-free or therapy electrodes affects the current required to obtain ventricular capture. Typically the lowest threshold is obtained when the position of the electrodes provides the most direct current pathway through the heart while avoiding large chest muscles. Lower stimulation currents produce less skeletal muscle contraction and are better tolerated.

## Pediatric Pacing

Noninvasive pacing of pediatric patients is performed in an identical manner to adult pacing. Smaller size pediatric therapy electrodes are available for patients weighing less than 33 lbs/15 kg. If it is necessary to pace for more than 30 minutes, periodic inspection of the underlying skin is strongly advised. Carefully follow all instructions on electrode packaging.

### Pace Fault

The X Series unit may display the following messages when pacing.

System Message	Description
<i>PAUSED</i>	The pacer has paused pacing the patient.
<i>PACING</i>	The pacer is pacing the patient.
<i>PACING: CHECK THERAPY ELECTRODES</i>	Therapy pads are not connected or are not making good contact with the patient. Apply therapy pads to the patient.
<i>ECG FAULT: PACING IN FIXED MODE</i>	The pacer is pacing in Fixed mode because the ECG lead displayed in the primary waveform is faulted.
<i>PACING: SHORT DETECTED</i>	The pacer output is short circuited due a test plug connection or a device/MFC fault.





# Chapter 19

## Real CPR Help

---



Real CPR Help is defibrillation-proof Type BF equipment.

---

**WARNING! Do not use Adult CPR electrodes with patients under 8 years of age.**

---

When used with CPR-D-padz, CPR Stat-padz or OneStep CPR electrodes, the X Series unit can provide rescuers with feedback about the quality of CPR they are delivering to their patients. The way in which feedback is provided varies with respect to the operational mode and user configuration, but is derived from compression rate and depth measurements.

When applied according to package instructions, ZOLL CPR-D-padz, CPR Stat-padz and OneStep CPR electrodes provide a chest compression sensor that is located between the rescuer's hands and the patient's lower sternum. This sensor monitors the rate and depth of chest compressions and sends this information to the X Series unit for processing and display.

The X Series defibrillator's CPR features include:

- **Voice prompts and text messages** (screen prompts), which give rescuers feedback about the depth of chest compressions.
- **CPR Metronome**, which encourages rescuers to perform chest compressions at a rate that falls within AHA/ERC recommended guidelines.
- **FULLY RELEASE prompt**, which instructs rescuers to lift (fully release) their hands from the patient's chest after compressions.
- **Real CPR Help Dashboard**, which displays CPR rate and depth measurements, and graphic indicators for CPR Release and Compression.
- **CPR Compression Bar Graph**, which displays a minimum of 12 seconds of compression depth information.
- **See-Thru CPR**, enables the rescuer to see a close approximation of the patient's underlying ECG rhythm while performing CPR (we describe See-Thru CPR in Chapter 20).

The CPR features that the X Series unit provides differ depending whether adult or pediatric CPR electrodes are attached to the unit. The X Series unit automatically senses which type of CPR electrode is attached, and provides the CPR features as follows:

<b>CPR Feature</b>	<b>Adult CPR Features</b> (Available when CPR-D padz, CPR Stat-padz and Adult OneStep CPR Electrodes are attached.)	<b>Pediatric CPR Features</b> (Available when Pediatric OneStep CPR Electrodes are attached.)
Voice and Text Prompts	+	
CPR Metronome	+	+
<i>FULLY RELEASE</i> Prompt	+	
CPR Rate and Depth Measurements (CPR Dashboard)	+	+
CPR Release Indicator (CPR Dashboard)	+	
CPR Depth Indicator (CPR Dashboard)	+	
CPR Countdown Timer (CPR Dashboard)	+	+
CPR Depth Idle Time Display (CPR Dashboard)	+	+
CPR Compression Bar Graph	+	

We describe the X Series defibrillator's CPR features in the following sections.

## CPR Voice Prompts (Adult Only)

The X Series unit can be configured to issue voice prompts related to the depth of chest compressions as feedback to rescuers performing CPR. Two voice prompts are available for this purpose:

- Push Harder
- Good Compressions

When chest compressions are detected but their depth is consistently less than the target depth (AHA/ERC 2005: 1.75, AHA/ERC 2010/2015: 2.0), the device periodically issues the “Push Harder” voice prompt. If the rescuer responds by increasing compression depth to more than the target depth on a consistent basis, the unit issues a “Good Compressions” prompt.

CPR voice prompts are only available when using Adult CPR electrodes.

## CPR Metronome

The X Series unit includes a CPR metronome feature that can be used to encourage rescuers to perform chest compressions at a rate that falls within AHA/ERC recommended guidelines.

The CPR metronome can be configured to operate in all modes (AED, Manual, and Analysis/CPR Protocol), or in AED mode only. The CPR metronome can also be disabled for all modes. When activated, the metronome beeps at the AHA/ERC recommended rate to provide a compression rhythm for rescuers to follow.

The CPR metronome’s Constant Metronome feature allows the metronome to continue beeping under certain circumstances. When Enable Metronome is set to Never in the Supervisor>CPR menu, Constant Metronome is greyed out.

The CPR metronome can be configured as follows.

### Constant Metronome Enabled

#### **AED Mode**

- If Enable Metronome is set to Always or AED Mode Only, the metronome is active when chest compressions are first detected during the CPR interval. The metronome is silent when the CPR idle timer starts.
- If set to Never, the metronome is silent.

#### **Analysis/CPR Protocol or Manual Mode**

- If Enable Metronome is set to Always, the metronome is active when chest compressions are first detected during the CPR interval. The metronome is silent when the CPR idle timer starts.
- If set to AED Mode Only or Never, the metronome is silent.

## Constant Metronome Disabled

### AED Mode

- If Enable Metronome is set to Always or AED Mode Only, the metronome is active at the start of the CPR interval.
- If set to Never, the metronome is silent.

### Analysis/CPR Protocol or Manual Mode

- With AHA/ERC 2005/2010 Guidelines Enabled  
If Enable Metronome is set to Always, the metronome is active only when the reported compression rate falls below 80 cpm during the CPR period. If the chest compression sensor is connected, the metronome is suspended after compressions have not been detected for at least 2 seconds.
- With AHA/ERC 2015 Guidelines Enabled  
If Enable Metronome is set to Always, the metronome is only active when the reported compression rate falls above or below the 2015 guideline range of 100-120 cpm during the CPR period. If the chest compression sensor is connected, the metronome is suspended after compressions have not been detected for at least 2 seconds.
- If set to Never or AED Mode Only, the metronome is silent.

The following table indicates when the CPR metronome is active.

Enable Metronome Setting	AED Mode	Analysis/CPR Protocol Mode	Manual Mode
<b>Constant Metronome Enabled</b>			
AED Mode Only	On when CPR detected Off when CPR Idle	Off	Off
Always	On when CPR detected Off when CPR Idle	On when CPR detected Off when CPR Idle	On when CPR detected Off when CPR Idle
Never	Off	Off	Off
<b>Constant Metronome Disabled</b>			
AED Mode Only	On at start of CPR period	Off	Off
Always	On at start of CPR period	<ul style="list-style-type: none"> <li>• With AHA/ERC 2005 or 2010 Guidelines, on only at &lt;80 compressions per minute.</li> <li>• With AHA/ERC 2015 Guideline on when compression rate falls above or below 100-120 compressions per minute.</li> </ul>	<ul style="list-style-type: none"> <li>• With AHA/ERC 2005 or 2010 Guidelines, on only at &lt;80 compressions per minute.</li> <li>• With AHA/ERC 2015 Guideline on when compression rate falls above or below 100-120 compressions per minute.</li> </ul>
Never	Off	Off	Off

## FULLY RELEASE Prompt

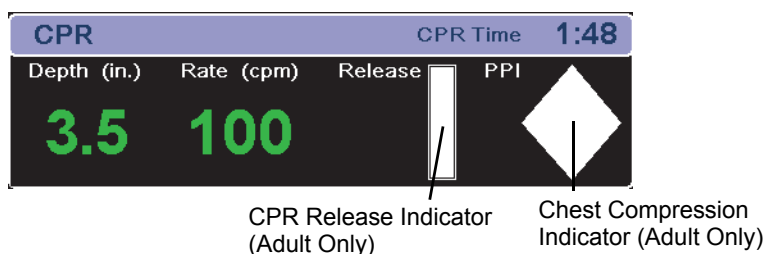
The X Series unit can be configured to display the text prompt FULLY RELEASE, which instructs rescuers to lift (fully release) their hands from the patient's chest after compressions to allow full recoil. This prompt occurs 45 seconds into the CPR interval.

The *FULLY RELEASE* text prompt is only available when using Adult CPR electrodes.

## CPR Dashboard

Whenever CPR-D-padz or OneStep electrodes are connected to the X Series defibrillator and it senses compression, the unit illuminates the CPR Dashboard in the lower center portion of the display.

The CPR Dashboard displays CPR feedback indicators, which differ, depending on whether adult or pediatric CPR electrodes are attached to the unit. We describe the CPR Dashboard's feedback indicators in the following sections.



**Note:** If no compressions have been detected for at least 3 seconds or if the compressions fall below the display range of rate and depth indicators, the rate Depth and Rate fields display dashes (----).

## CPR Rate and Depth Measurements

The display of CPR rate and depth measurements differ depending on whether adult or pediatric CPR electrodes are attached.

### With Adult CPR Electrodes Attached --

By default, the X Series unit displays CPR rate and depth measurements in green when adult CPR electrodes are attached.

For units configured to use AHA/ERC 2005 or 2010 Guidelines, if the unit detects that CPR performance is consistently below the AHA/ERC-recommended compression rate, the unit displays the rate measurement in yellow (*needs improvement*). Likewise, if the unit detects that compression depth is consistently below the AHA/ERC-recommended compression depth, the unit displays the depth measurement in yellow (*needs improvement*).

For units configured to use AHA/ERC 2015 Guidelines, if the unit detects that CPR performance is consistently above or below the AHA/ERC-recommended compression rate, the unit displays the rate measurement in yellow (*needs improvement*). Likewise, if the unit detects that compression depth is consistently above or below the AHA/ERC-recommended compression depth, the unit displays the depth measurement in yellow (*needs improvement*).

This color coding is intended to assist the rescuer in determining whether the chest compression rate or depth should be increased or maintained.

### With Pediatric CPR Electrodes Attached --

CPR rate and depth measurements *always* display in green when pediatric CPR electrodes are attached.

## CPR Release Indicator (Adult Only)

The CPR Release Indicator is intended to provide feedback on the rescuer's ability to fully lift his hands off the sternum during the upstroke of the compression. The release indicator is filled when rescuers release compressions more quickly, whereas the indicator will only fill partially if chest compression release is slow.

The CPR Release Indicator is only available when using Adult CPR electrodes.

## Chest Compression Indicator (Adult Only)

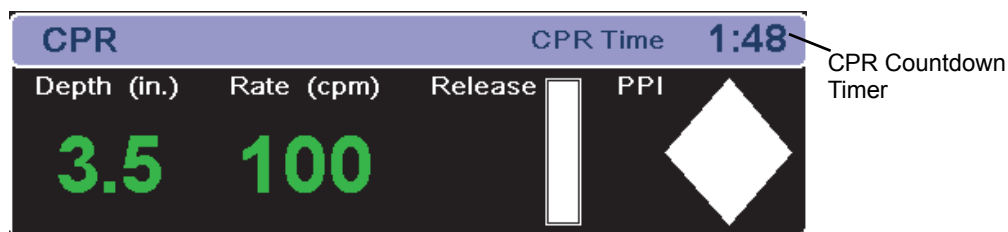
This diamond-shaped figure provides a quick, overall indicator of how well the rescuer's combined rate and depth of chest compressions match the AHA/ERC recommendations for adult CPR.

The CPR Compression Indicator, also known as Perfusion Performance Indicator™ (PPI), is first displayed as an empty diamond. This indicator starts to fill as compressions begin (filling from the inside), and becomes completely filled when consistent chest compression depth exceeding (AHA/ERC 2005: 1.75, AHA/ERC 2010/2015: 2.0, AHA/ERC 2015: 2.0-2.4) inches and rate exceeding 90 compressions per minute (cpm) are achieved simultaneously. Should the chest compression rate or depth begin to fall below the configured target levels, the indicator will only partially fill to indicate the need for more rigorous efforts. Following the cessation of compressions, the indicator's fill level gradually decreases until a hollow outline is displayed after a short period of time.

The CPR Compression Indicator is only available when using Adult CPR electrodes.

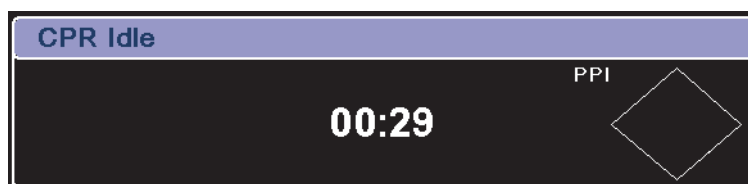
## CPR Countdown Timer

The X Series unit displays a CPR Countdown Timer to indicate the time (in minutes and seconds) left in the current CPR interval. It decrements the time until it reaches zero. The CPR dashboard disappears if the CPR electrodes are disconnected.



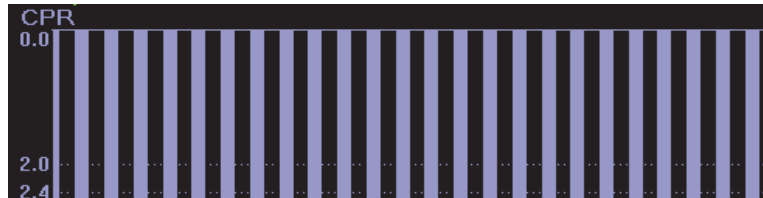
## CPR Idle Time Display

This display indicates the elapsed time in minutes and seconds since the last detected chest compression. Ten seconds following the cessation of compressions, the idle time is displayed. As soon as a new compression is detected, the idle time is removed from the screen. If no compressions have been detected for at least 20 minutes, dashes (- - : - -) are displayed in this time field.



## CPR Compression Bar Graph (Adult Only)

When Adult CPR electrodes are attached, the X Series unit can display a CPR compression bar graph next to the dashboard that is computed from the CPR sensor signals. This bar graph, representing depth of compression, is presented on a (AHA/ERC 2005: 0 - 2.1, AHA/ERC 2010: 0 - 2.5) inch displacement scale with reference markers at (AHA/ERC 2005: 1.5 and 2.0, AHA/ERC 2010: 2.0 and 2.4) inches. The unit displays a minimum of 12 seconds of compression data at a rate of approximately 133 compressions per minute.



The CPR Compression Bar Graph is only available when using Adult CPR electrodes.





# Chapter 20

## See-Thru CPR

---

See-Thru CPR is an optional feature in the X Series.

---

**WARNING!** The See-Thru CPR filter works only when the X Series defibrillator is monitoring CPR in Manual mode.

The See-Thru CPR filter stops if:

- The unit is in pace mode.
- Patient impedance is invalid.
- ZOLL OneStep CPR electrodes, OneStep Complete electrodes, CPR-D-padz or CPR Stat-padz are no longer detected.

The See-Thru CPR filter will not remove all CPR artifact. Always stop CPR to verify the patient's ECG rhythm before making treatment decisions.

The See-Thru CPR filter does not operate during ECG rhythm analysis. Always stop chest compressions during ECG rhythm analysis to avoid incorrect results caused by the presence of CPR artifact.

Diagnostic bandwidth is never applied to the See-Thru CPR waveform.

---

See-Thru CPR enables the rescuer to see a close approximation of the patient's underlying ECG rhythm while performing CPR. See-Thru CPR is available if the X Series is monitoring CPR.

Chest compressions introduce *CPR artifact* into the ECG signal. See-Thru CPR uses a filter that relies on the correlation between CPR compressions, as detected by the ZOLL Onestep, OneStep Complete, CPR-D-padz or CPR Stat-padz and the CPR artifact to remove much, but not all, of the artifact from the ECG signal. Under some conditions, residual noise after filtering can obscure the ECG rhythm, requiring the rescuer to stop CPR to assess the ECG. For example, in the case of asystole or low amplitude PEA, the residual artifact seen after filtering may look like fine ventricular fibrillation.

Because the filtered ECG signal may contain residual chest compression and/or filtering artifacts, *a rescuer should always follow the standard procedure of stopping CPR to assess the patient's ECG rhythm before determining treatment.*

## Using See-Thru CPR

To use See-Thru CPR

- The X Series unit must be monitoring CPR.
- ZOLL OneStep CPR pads, OneStep Complete pads, CPR-D-padz or CPR Stat-padz must be attached to the unit.

When chest compressions begin, the X Series unit *automatically* starts filtering the CPR artifact after detecting the first 3 to 6 compressions. The filtered ECG, with the label "FIL," may be displayed on the second or third trace (by selecting **FILT ECG** in the Trace2 or Trace3 menu).

See-Thru CPR filtering continues as long as the OneStep CPR, OneStep Complete, CPR-D-padz or CPR Stat-padz detect compressions and patient impedance is valid. When no compressions are detected or one of the conditions noted above occurs, See-Thru CPR filtering stops, and unfiltered ECG signals are displayed. When compressions resume, filtering automatically restarts after 3 to 6 chest compressions.

**Note:** There is a delay of approximately 1/16 second between the See-Thru CPR waveform and the Trace 1 ECG waveform.

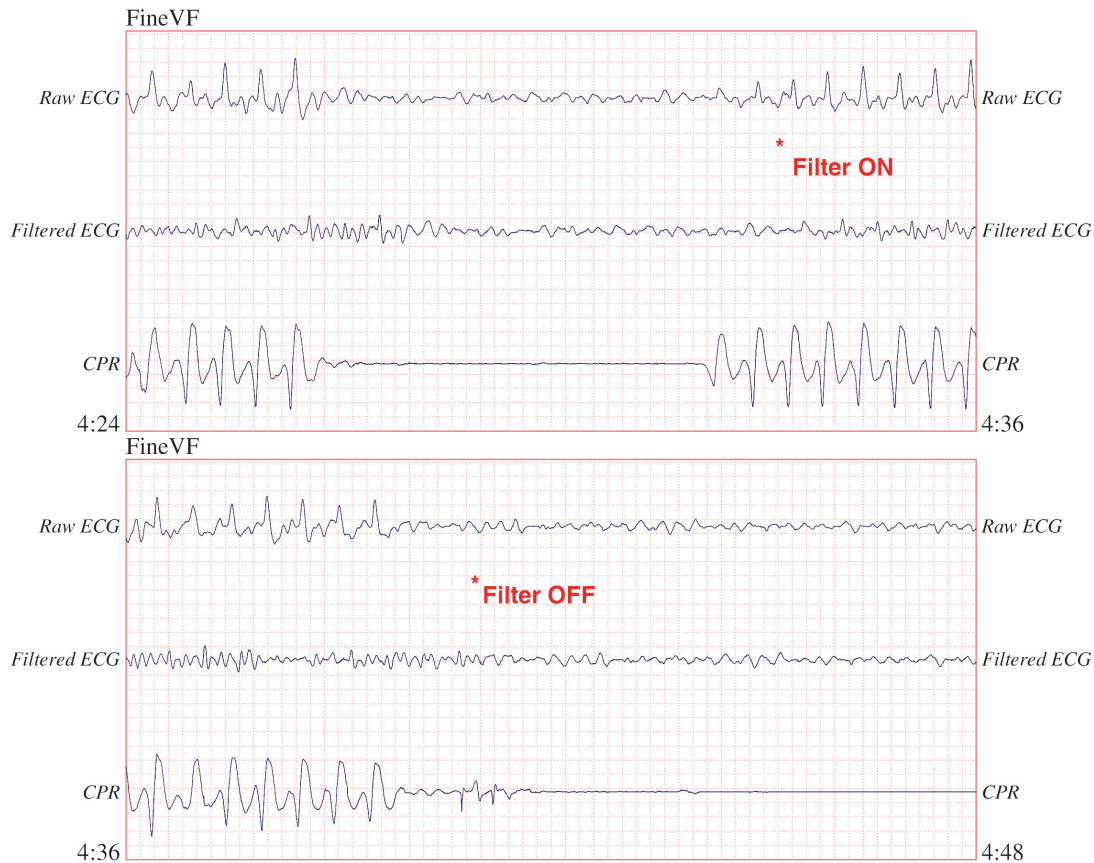
## Examples

The following examples show the effects of See-Thru CPR filtering on ECG signals contaminated with CPR artifacts.

Each example includes:

- ECG signal with CPR artifact.
- ECG signal after the See-Thru CPR filter has removed CPR artifact.
- Indication of the period during which See-Thru CPR is active.
- CPR signal to show when CPR activity occurred.

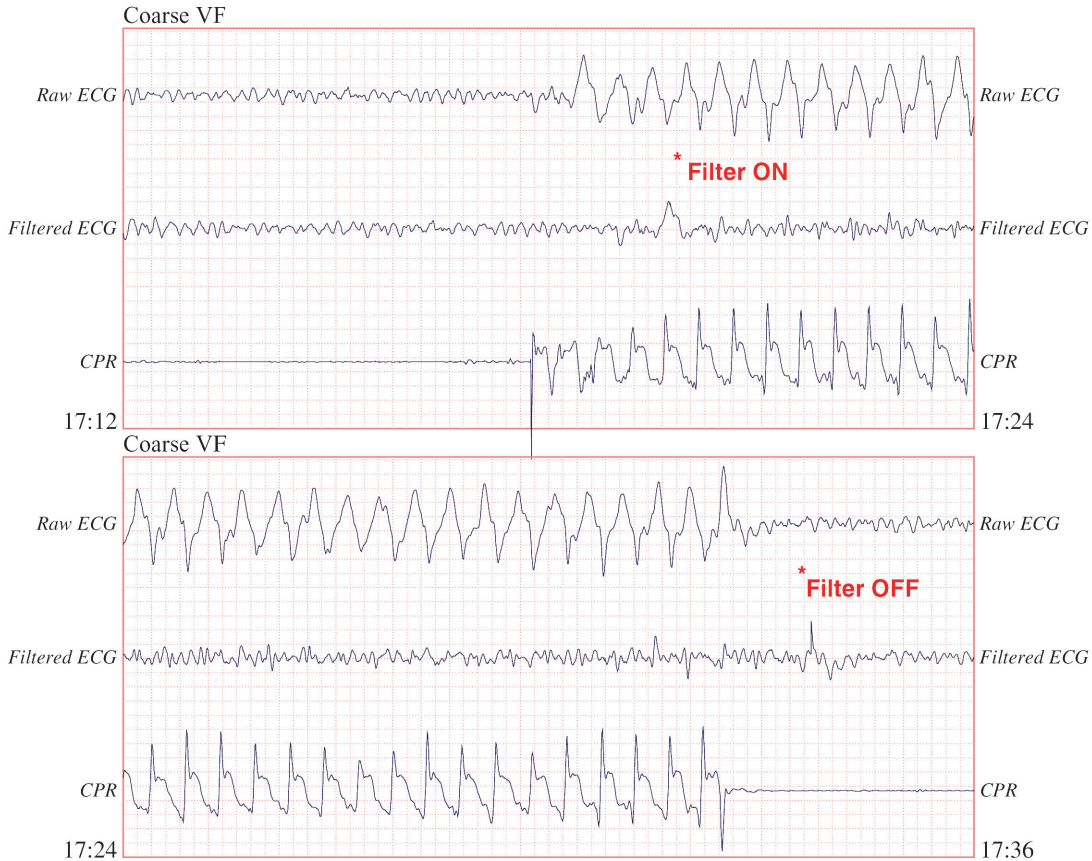
The following figure shows a patient in Fine VF. It is difficult for a rescuer to discern this rhythm during CPR compressions. When the CPR filter turns on, the Fine VF rhythm becomes more obvious.



Copyright © Massachusetts Institute of Technology 2011. All rights reserved.

12.5 mm/sec, 5 mm/mV

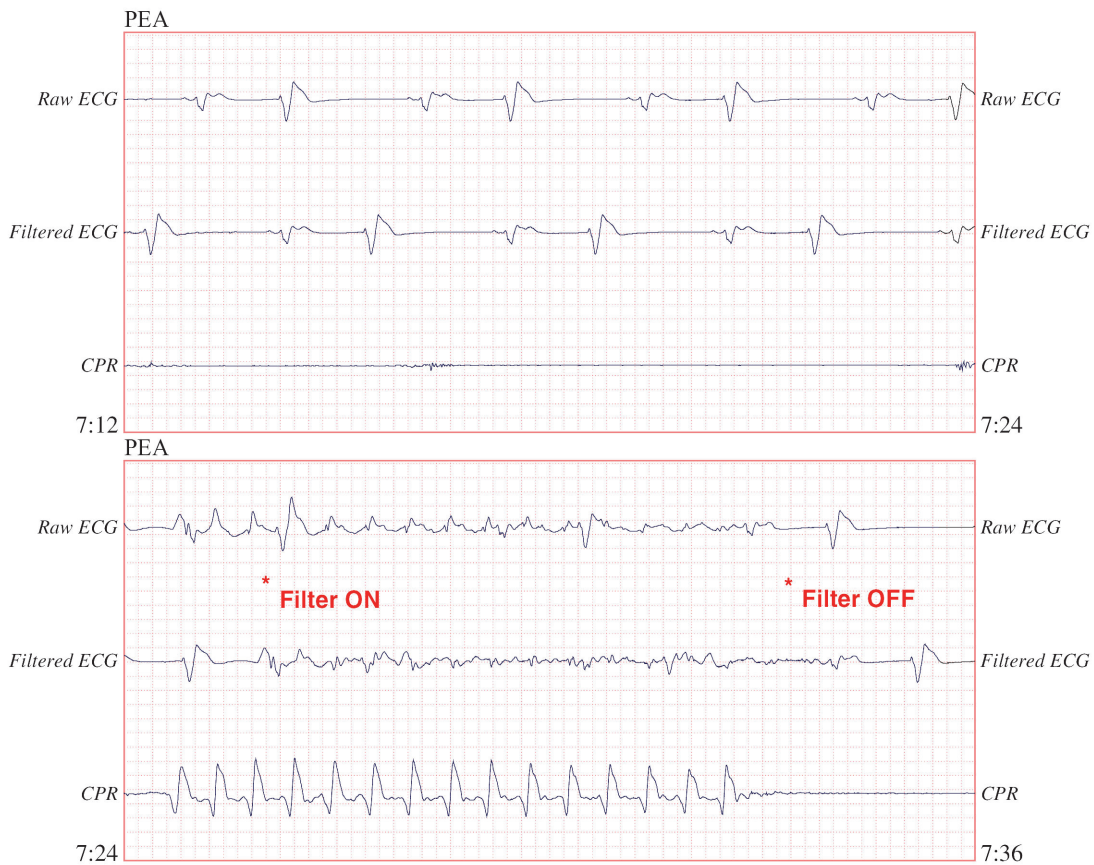
The following figure shows a patient in VF, which, during compressions, is slightly more difficult to discern. When viewing this ECG, it is possible to view the underlying rhythm as the filter is able to reject all of the CPR artifact.



Copyright © Massachusetts Institute of Technology 2011. All rights reserved.

12.5 mm/sec, 5 mm/mV

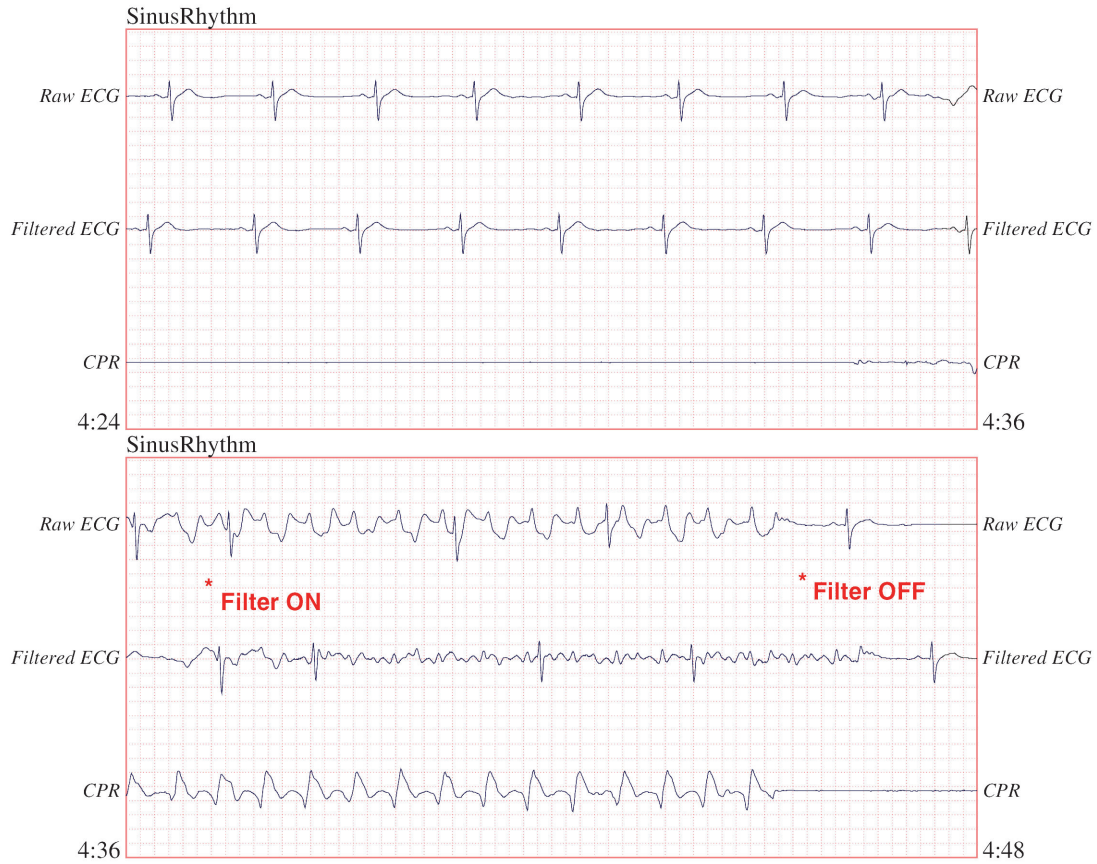
The following figure shows a patient in PEA, which could easily be mistaken for Fine VF because enough of the compression artifact leaks through to distort this signal. When the CPR filter turns on, the PEA is still not obvious because of the left over ripples from the CPR signal. About 14 seconds into this chart, the rhythm changes to asystole, which could easily be mistaken for coarse VF. When the CPR filter turns on, the CPR compression ripples are still obvious, making the rhythm look like Fine VF.



Copyright © Massachusetts Institute of Technology 2011. All rights reserved.

12.5 mm/sec, 5 mm/mV

The following figure shows a patient with an organized rhythm where See-Thru CPR effectively filters out artifact created by CPR.



Copyright © Massachusetts Institute of Technology 2011. All rights reserved.

12.5 mm/sec, 5 mm/mV

# Chapter 21

## Patient Data

---

This chapter describes procedures for storing, viewing, and transferring patient data from the X Series to an external system, such as a personal computer or handheld device.

**Note:** Before deleting log files from the X Series, view the files on a personal computer to verify that they have been successfully transferred.

**Note:** Data transfers will not be successful if the USB flash storage device is full or does not have sufficient memory available. Always use a USB flash storage device that has at least 128 MB available.

---

**WARNING!** Do not connect non-isolated equipment to the USB port while monitoring a patient.

---

## Storing Data

The X Series unit continuously stores information in a full disclosure case log for the patient being monitored. The X Series can maintain up to 150 full disclosure cases that contain treatment events, trends, ECG and other continuous waveforms, monitoring and event snapshots, and 12-lead snapshots and analysis. The X Series unit can, at a minimum, concurrently store the following information:

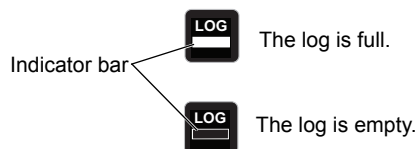
- 32 monitor snapshots
- 500 non-ECG events
- 24 hours of continuous ECG (4 waveforms), Capnography, IBP (3 channels), and Pads Impedance

The actual information that is stored depends on usage. Also, the specific combination of stored continuous waveform data depends on how the waveform recording settings are configured in the Supervisor menu.

**Note:** The X Series unit retains stored cases even if you turn off or remove the auxiliary power adapter.


## Log Capacity Indicator

The Log quick access key has an indicator bar which shows an approximation of the current level of data storage in the log.



When data storage reaches its capacity, the unit performs automatic log management by deleting the oldest full disclosure case. If the log is not cleared or transferred, the X Series unit continues to delete cases as needed to acquire storage capacity. For more information on clearing or transferring the log, see page 21-4.

## Capturing a Data Snapshot

Press the Snapshot button (  ) on the front panel to capture a 24-second period of numeric and waveform patient data. The unit captures 12 seconds preceding and 12 seconds following the button press.

The X Series unit can store a minimum of 32 snapshots, including:


- Monitor snapshots
- Defibrillator snapshots
- Treatment snapshots
- Pacer snapshots
- Alarm snapshots
- Presenting Rhythm snapshots

**Note:** Presenting Rhythm snapshots are only taken at the start of a new patient. The snapshot will not be retaken if the unit is shut off for less than two minutes.



## Reviewing and printing snapshots

You can perform this procedure from any main display screen.

1. Press the Home/Display button () repeatedly until the Trends window displays.
2. Use the navigation keys to get to the Trends window.
3. Press the Select button to scroll through the list of trends.

**Note:** The snapshots have a snapshot icon next to the time stamp.

4. Select the desired snapshot from the Trends list and press Select. The snapshot numeric data displays.
5. To print the data and the snapshot waveforms, highlight **Print this Snapshot** and press Select.

**Note:** If you attempt to print a snapshot before the unit has finished storing the snapshot in the log, a *NO DATA AVAILABLE* message is printed. To print the snapshot correctly, wait until the snapshot is complete, then select and print it again.




## Treatment Summary Report

The Treatment Summary Report is a report that shows all of the treatment events related to a patient such as defibrillation/pacer events, alarm events, and treatment snapshots. It is helpful to print out this report at the end of a case.

TREATMENT SUMMARY REPORT			
Name: Phillip Davies		06:06:14	New Case ID
ID: Patient 0015	Patient Mode: Adult	06:06:14	System On
Start Time: 06/06/11	06:06:14	06:06:14	Patient Mode Adult
Last Event: 06/06/11	09:43:40	06:06:14	Some Alarm Limits Disabled
Elapsed Time: 00:29:48	# Events:	06:06:20	Self Test Passed
Total Shocks: 1		06:06:43	Treatment Snapshot: ASA
Total Pace			
Time: 00:00:00			
Total 12 Leads: 0			
Dept: ICU			
Unit:			
S/N: 0	SW: 00.00.00.00		

## Printing Treatment Summary Report

To print a treatment summary report, do the following:

1. Press the More quick access key ()
2. Press the Log quick access key ()
3. Press the Treatment Summary quick access key () . The Treatment Summary window displays.
4. Use the navigation keys to highlight and select the treatment summary you want to print.

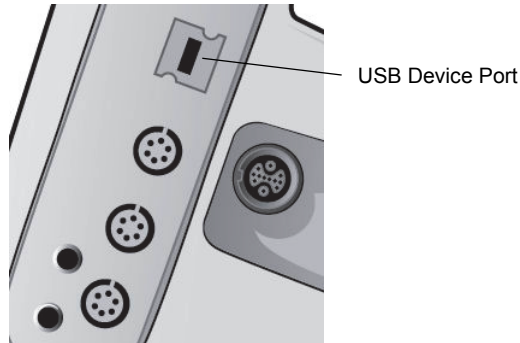
**Note:** The Treatment Summary Report that you selected has a check mark next to it.

5. Use the navigation keys to highlight and select **Print Treatment Summary**.

## Transferring Data to a USB Device




You can transfer a full disclosure log containing patient data from the unit using a USB transfer device.

Before you begin, insert a USB device into the X Series USB device port.



**Figure 21-1. USB Port**

To transfer data through the USB port:

1. Press the power switch to turn the unit on.
2. Press .
3. Press .
4. Press the Transfer Log quick access key () (ensure that the USB drive is connected to the device).

**Note:** Do not remove the USB data drive from the X Series unit during transfer.

5. Use the navigation keys to select **Transfer** from the Transfer the Log menu.
6. The green LED on the top of the device turns on while data is transferred to the USB device.

**Note:** Wait for the log transfer to complete and for the green light on the top of the X Series to turn off before removing the USB drive.

**Note:** Printing and logging snapshots is disabled during the log transfer.

After transferring data, you must remove the USB drive and reinsert it before attempting another transfer. If the USB device does not establish communication with the X Series unit, try powering off the unit and then on again to establish communication.

---

**Warning!** To avoid a possible shock hazard, do NOT make any electrical connections to the USB port except to connect a USB flash drive while in the vicinity of the patient.

---




---

## Clearing the Log

You should clear the full disclosure log after transferring data to the USB device or when the log is nearing its capacity.

**Note:** Clearing the log during patient treatment results in the loss of all patient data and events recorded prior to clearing the log.

To clear the log:

1. Press .
2. Press .
3. Press the Clear Log quick access key ()
3. Use the navigation keys to select **Yes**.

**Note:** An *UNABLE TO READ LOG* message indicates that the log contains no information. This message can occur if you clear the log and then immediately enter the Treatment screen or the Trend Summary screen.



# Chapter 22

## Communications

---

If installed, the X Series unit is equipped to communicate through a Wi-Fi access point, Bluetooth-equipped device, Ethernet cable, or USB cellular modem. You can send data through a wireless connection to a remote recipient via a ZOLL server configured for your unit or you can use an Ethernet adapter to transfer data to a PC via an Ethernet cable.

**Note:** The X Series Unit does not support simultaneous Wi-Fi and Ethernet communication.

The data available to transmit to a remote location includes 12-lead report snapshots (including trend data) as well as the Disclosure logs for up to 15 cases at one time. The X Series unit continuously stores information in a full disclosure case log for monitored patients. The disclosure logs contain treatment events, trends, ECG and other continuous waveforms, monitoring and event snapshots, and 12-lead snapshots and analysis.

**Note:** Full disclosure cases, can also be automatically retrieved from the X Series unit using ZOLL RescueNet or ePCR software or saved to a USB device.

You can set up a Bluetooth pairing or temporary wireless access point on the X Series unit by selecting the wireless icon on the display screen. Supervisors can set up permanent communications configuration, including up to 255 Wi-Fi profiles and up to 3 Cellular providers in the Setup/Communications menu, which requires a password. Once you have set up a wireless connection, you can send 12-lead reports or disclosure logs via a ZOLL server.







This chapter describes how to set up and use communications capabilities in the X Series unit. This chapter contains the following sections:

- The Wireless Icon
- The Wireless Menu
- Sending a 12-Lead Report
- Sending Disclosure Logs
- Supervisor Communications Menu
- Communications System Messages

**Important:** Test all wireless connections after initial setup and prior to use.

## The Wireless Icon

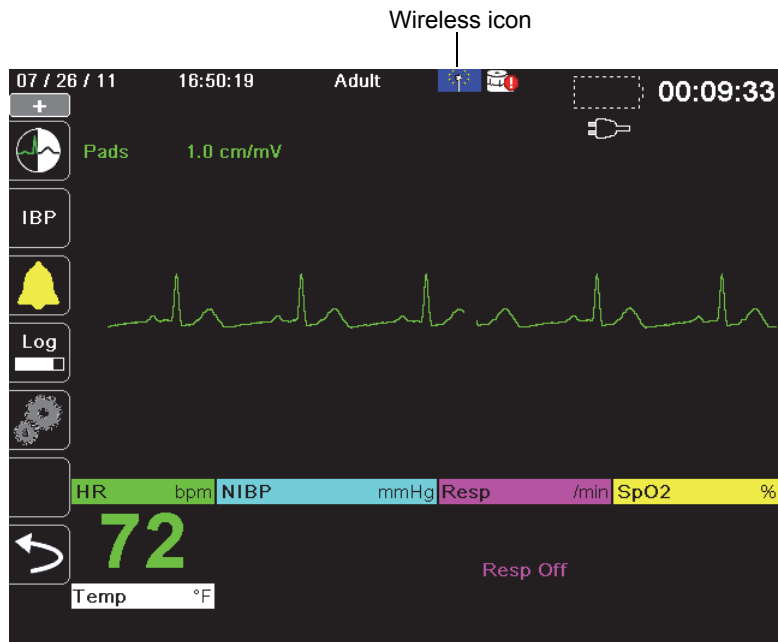
The wireless icon is located to the right of the patient mode in the display screen. It has five possible states shown the table below. If wireless connectivity is disabled, no icon is displayed.

State	Description
Connected 	Wireless connectivity is active using Wi-Fi, or USB cellular modem. For Wi-Fi, this is the normal operating state. For cellular modem, this icon appears only when a transmission is requested.
Not connected 	Wireless connectivity is inactive. If a Wi-Fi access point is selected, this icon indicates the selected network cannot connect due to incorrect configuration or weak/no signal strength. If the unit is configured to use Bluetooth or cellular modem, the unit will show this icon until a transmission is requested or a peer-to-peer connection becomes active.
Bluetooth Connected 	Bluetooth tethering (to a phone) or a Bluetooth peer-to-peer connection is active.
Failed 	Wireless communication hardware has failed.
Ethernet Connected 	Replaces the wireless icon when Ethernet is enabled. An adapter is connected, and the connection is operating.
Ethernet Not Connected 	Replaces the wireless icon when all of the following are true: <ul style="list-style-type: none"> <li>• Ethernet is enabled.</li> <li>• Wireless is disabled.</li> <li>• An Ethernet adapter is connected but the connection is not active.</li> </ul>
No icon	All wireless connectivity is disabled.

You can select the Wireless icon to access the Wireless menu where you can:

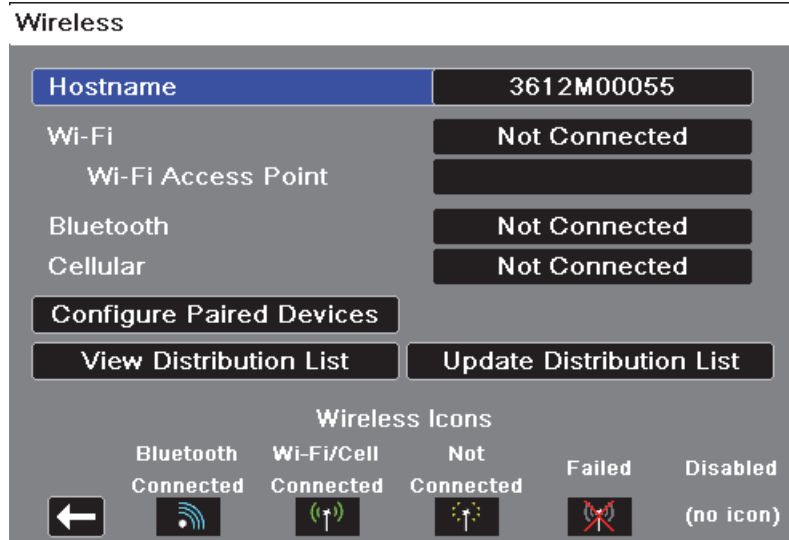
- Select preconfigured Wi-Fi access points.
- View connection details.
- View Bluetooth paired devices.
- View or update 12-Lead distribution lists.
- Set up a temporary Wi-Fi access point.
- Set up a Bluetooth connection.

Use the navigation keys to select the wireless icon.



## The Wireless Menu

The Wireless menu has the following options: **Wi-Fi Access Point**, **View/Configure Paired Devices**, **View Distribution List**, and **Update Distribution List**. Use the navigation keys to navigate the menu items; press the back arrow (←) to exit the wireless menu.





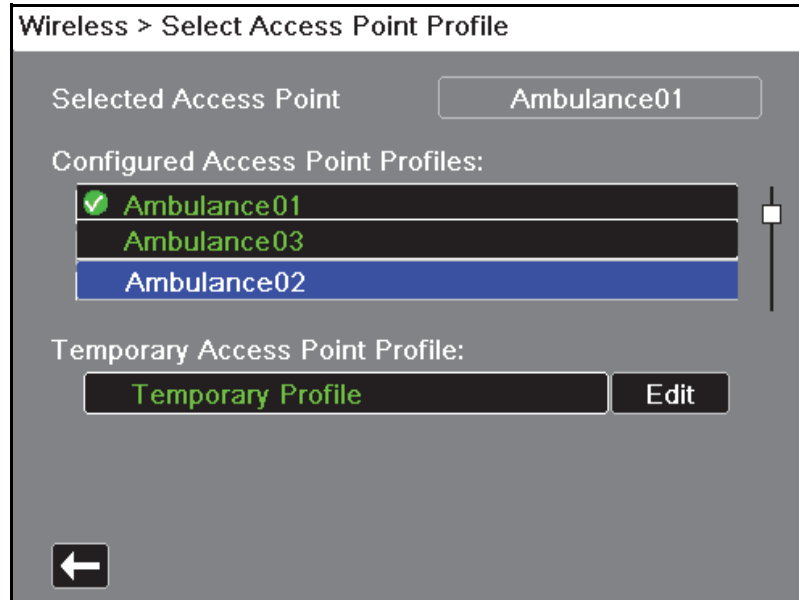
## Selecting a Pre-Configured Access Point Profile

You can make a wireless Access Point profile active by selecting an access point from a list of pre-configured wireless Access Point profiles.

To make an Access Point Profile active:

1. Use the navigation keys to highlight and select **Wi-Fi Access Point**. The X Series scans for Wi-Fi access point that are within range then displays a list of available pre-configured Access Point Profiles with those that are in range appearing at the top of the list. In addition, the X Series colorizes the profiles where:

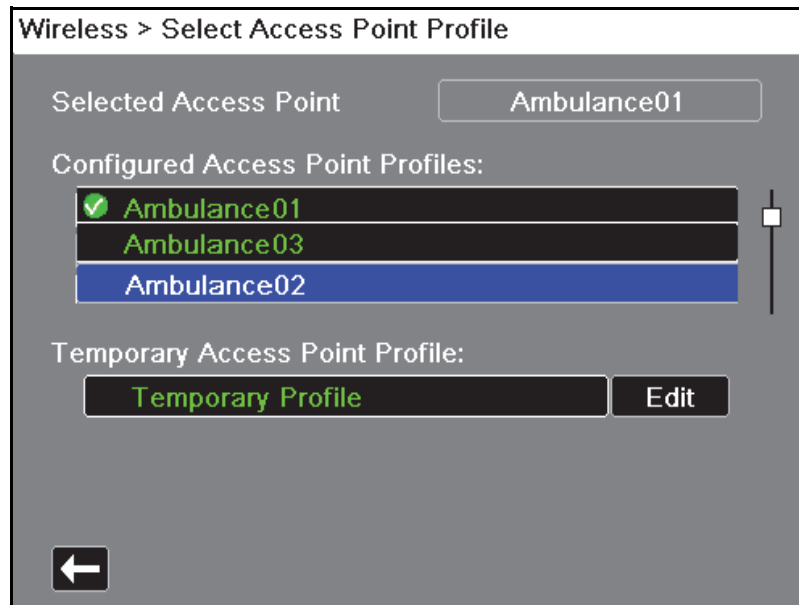
<b>This Color:</b>	<b>Indicates:</b>
<b>Green</b>	The profile is available and within range.
<b>White</b>	The profile: <ul style="list-style-type: none"> <li>• Is not within range.</li> <li>• Is for a network with a hidden SSID.</li> <li>• The X Series could not determine the availability of the profile.</li> </ul>



2. Navigate to and select a profile from the Configured Access Point Profiles list. A green check mark appears to show that the profile has been selected.
3. Press the back arrow (←) to return to the Wireless menu.

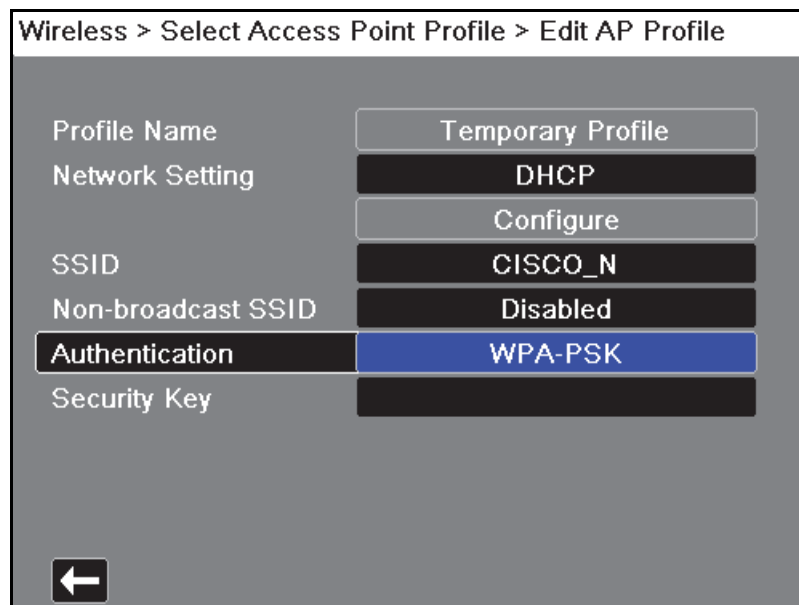
## Creating a Temporary Access Point Profile

When the unit has been moved to a temporary location and requires wireless access, you can create a Temporary Access Point Profile. In the wireless menu, use the navigation keys to highlight and select **Wi-Fi Access Point**. You can now view preconfigured Access Point Profiles.



Use the navigation keys to highlight and select **Temporary Profile**. A green check mark appears to show that the profile has been selected.

To edit the profile, use the navigation keys to highlight and select **Edit**. The unit displays the Edit AP Profile menu.

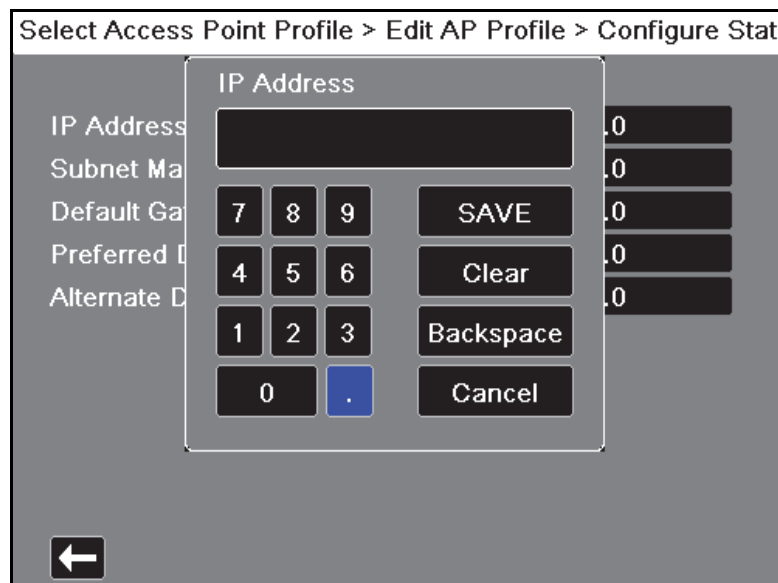


## Profile Name

The profile name is “Temporary Profile” and cannot be changed.

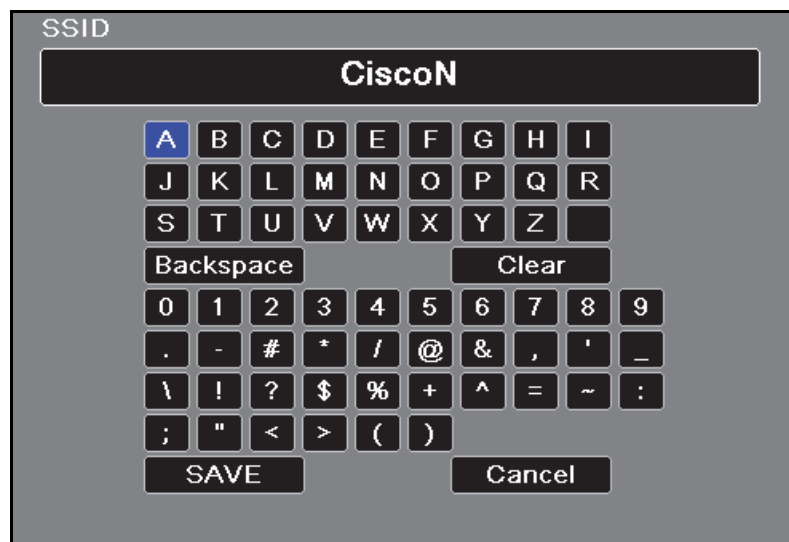
## Network Setting

Use the navigation keys to select either DHCP or Static IP. If you select Static IP, use the numeric keypad to enter values for the IP Address, Subnet Mask, Default Gateway, Preferred DNS Server, and Alternate DNS Server.



## SSID

Use the alphabetical keypad to enter the SSID name. Press **SAVE** to save changes and return to the Temporary Profile menu; press **Cancel** to return to the Temporary Profile menu without saving changes.



## Non-broadcast SSID

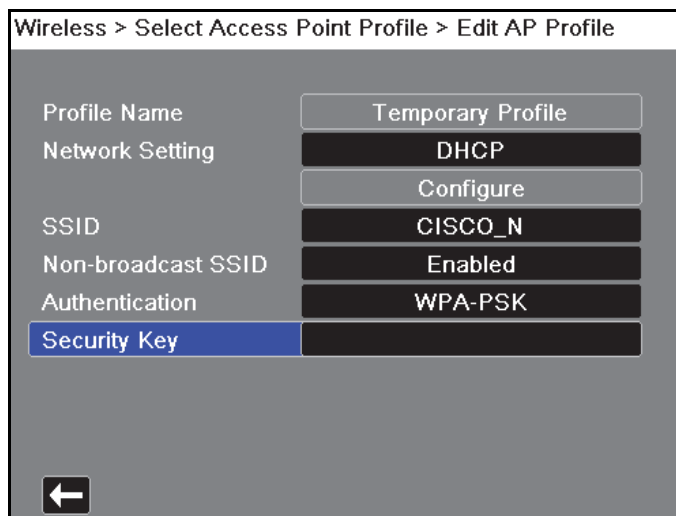
Use the navigation keys to enable or disable non-broadcast or hidden SSIDs. This must be set to Enabled to allow the X Series to connect to a Wi-Fi network that is configured not to broadcast its SSID.

## Authentication

Use the navigation keys to select the authentication type. The unit supports three types of Wi-Fi authentication:

- WPA-PSK (Wi-Fi Protected Access, Pre-shared key)
- WPA2-PSK (Wi-Fi Protected Access II, Pre-shared key)
- Enterprise

For WPA-PSK or WPA2-PSK, you are required to enter a security key (8-64 characters).



Wireless > Select Access Point Profile > Edit AP Profile

Profile Name	Temporary Profile
Network Setting	DHCP
	Configure
SSID	CISCO_N
Non-broadcast SSID	Enabled
Authentication	WPA-PSK
Security Key	

←

Use the alphabetical keypad to enter the security key. Press **SAVE** to save changes and return to the Temporary Profile menu; press **Cancel** to return to the Temporary Profile menu without saving changes.



Security Key

SECRETKEY

A	B	C	D	E	F	G	H	I	
J	K	L	M	N	O	P	Q	R	
S	T	U	V	W	X	Y	Z		
Backspace				Clear					
0	1	2	3	4	5	6	7	8	9
.	-	#	*	/	@	&	,	'	_
\	!	?	\$	%	+	^	=	~	:
;	"	<	>	(	)				
SAVE					Cancel				

### Configuring Enterprise Authentication

Further configuration is required for Enterprise; use the navigation keys to select **Enterprise Settings Configure**. You will be asked for the Identity, and Authentication Protocol (TLS or PEAP). Some fields will be greyed out, depending on the Authentication Protocol that you select. **PEAP (Protected Extensible Authentication Protocol)**: If PEAP (Protected Extensible

Select Access Point Profile > Edit AP Profile > Enterprise Cor

Identity	<input type="text"/>
Authentication Protocol	PEAP
Password	<input type="text"/>
Anonymous Identity	<input type="text"/>
Client Certificate	None
Private Key Password	None
Manage Client Certificates	
Load CA Certificate from USB	

←

Authentication Protocol) is selected, you must enter the Password corresponding to the Identity entered. If the network requires it, you may enter an Anonymous Identity. Other options on the screen will be greyed out.

**Note:** The X Series unit only supports PEAPv0/v1 + MSCHAPV2.

**TLS (Transport Layer Security):** If TLS is selected, you must select a Client Certificate and enter the Private Key Password corresponding to the private key in the Certificate file. Other options on the screen will be greyed out.

For all certificates and keys, you can choose from a list of pre-loaded files. See page 21 below for information on managing certificates and keys in the Supervisor menu.

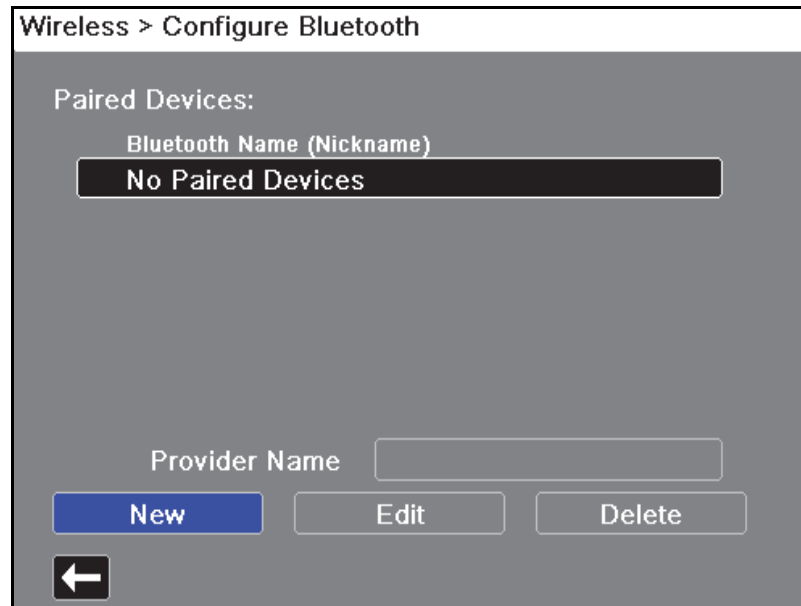
Press the back arrow (←) to return to editing the Temporary Profile.

When you are done editing the Temporary Profile menu, press the back arrow (←) to exit the wireless menu.

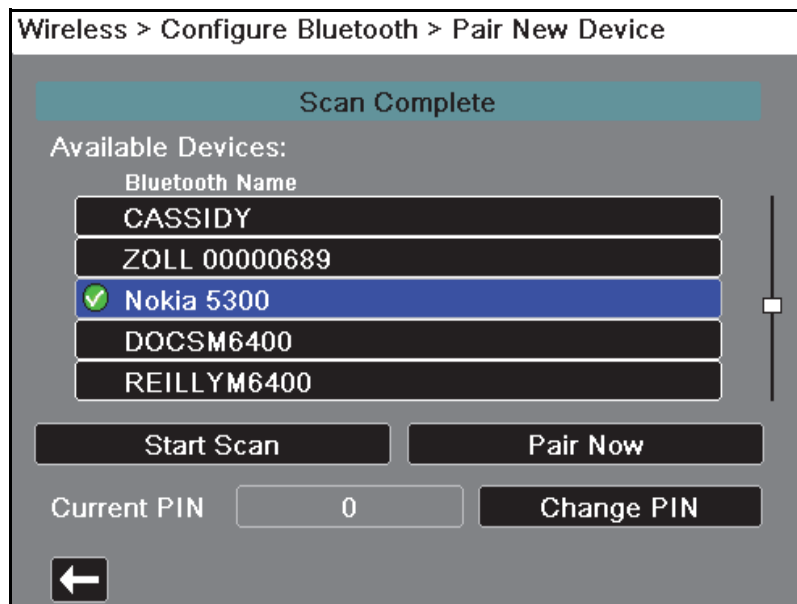
**Note:** The selected Temporary Profile remains selected until a different access point profile is chosen. You do not need to re-enter the configuration information.

## Bluetooth Device Pairing

In the wireless menu, use the navigation keys to highlight and select **View/Configure Paired Devices**. You can now view paired Bluetooth devices. To pair a new device, use the navigation keys and select **New**.



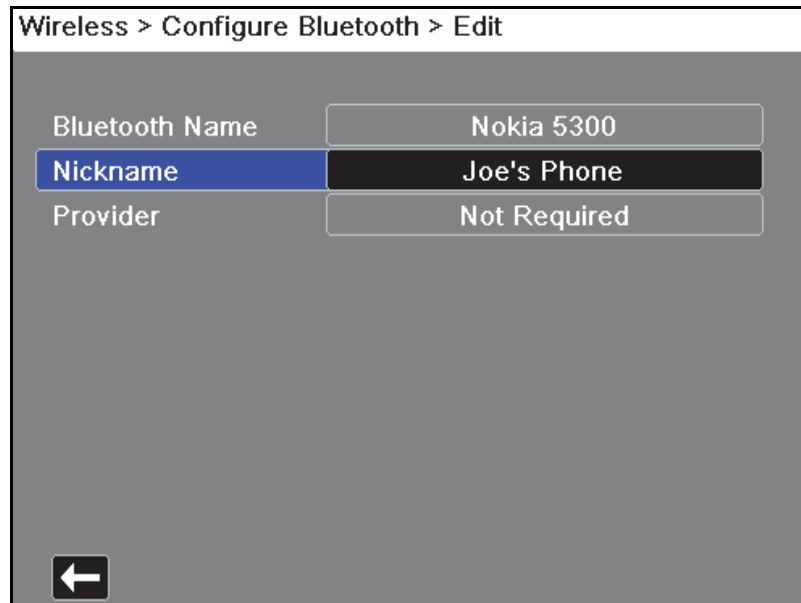
The unit will then scan for nearby Bluetooth devices that are in discoverable mode. Use the navigation keys to select the desired device; a green check mark indicates which device has been selected.



Select **Pair Now** to pair the device. On your Bluetooth device, accept the pairing request and enter the PIN, if prompted.

The unit then returns to the list of paired devices.

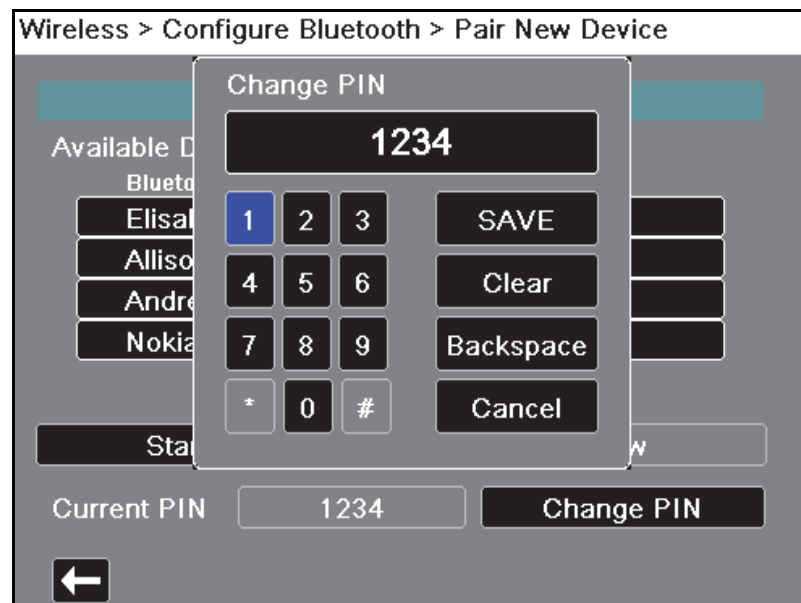
You can then edit the settings of the paired device, and give the device an optional nickname or provider. Press the back arrow (←) to return to the list of paired devices.



**Note:** Use Bluetooth devices with DUN or PAN-NAP profiles only. Contact your local ZOLL Medical Corporation sales representative for a list of approved devices.

### Changing the PIN

It may be necessary to change the PIN on the X Series unit; check your device's documentation. To change the PIN, select **Change Pin** in the Bluetooth menu, then use the numerical keypad to enter the desired PIN.



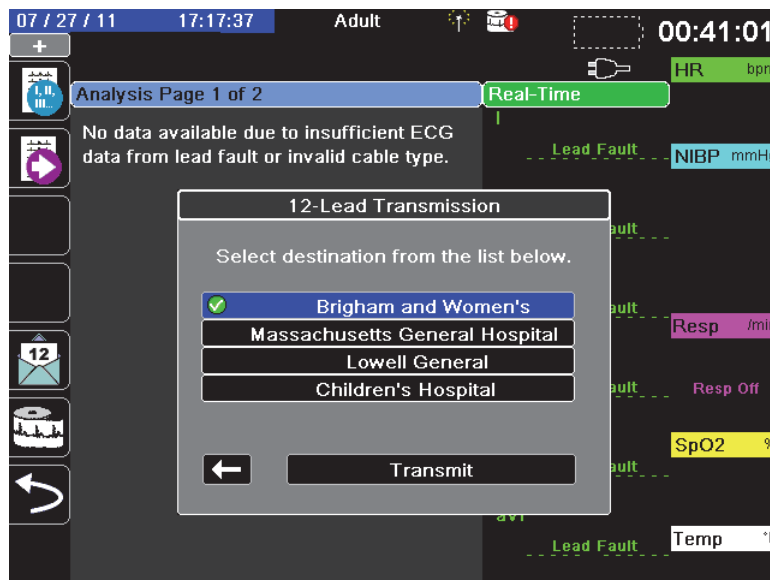
When finished pairing all Bluetooth devices, press the back arrow (←) to return the wireless menu. Press the arrow again to exit to the main screen.

## Sending a 12-Lead Report

When a 12-lead report has been acquired or a previously acquired 12-lead has been selected for review, the X Series unit prepares the report for transmission. When this is complete, the Transmit quick access key (12) displays.

To send a 12-lead report to a preconfigured distribution list:

1. Press the 12-lead quick access key (12).
2. If desired, press the snapshot button (120) to take a 12-lead snapshot (see Chapter 14: 12-Lead ECG Interpretive Analysis for more information about acquiring 12-lead data).
3. Press the 12-lead review next quick access key (121). A list of snapshots appears; select the desired snapshot.
4. Press (12). A list of preconfigured distribution lists appears.



Use the navigation keys to highlight and select the desired distribution list. A green check box indicates the selected list. When a destination has been selected, the **Transmit** button is enabled.

5. Press **Transmit** to initiate the 12-lead transmission.

While the transmission is in process, the green LED on top of the unit is illuminated and a message appears on the screen.





---

## Sending Disclosure Logs





For systems with a Disclosure log server configured, the X Series unit allows you to send patient disclosure logs for up to 15 cases at one time to a remote server through a wireless connection.



**Note:** The X Series unit automatically cancels any case disclosure log transmissions when defibrillation is activated.

To transfer disclosure log data:

1. From the Primary Display window press the **Log** button () then press the **Disclosure Log Transfer** quick access key (). The Close Current Case? dialog box displays.
2. Specify whether or not to include the current case in the transfer by navigating to and selecting:
  - **Close Case** if you would like to include the disclosure logs for the current case in the transfer. When you select **Close Case**, the X Series closes the current case and generates a new case for the current patient. That way Pacing, Defib, and AED parameter settings for the current patient remain intact following the transfer.
  - **Continue** button to continue the transfer without the current case.

The **Case Selection** dialog box displays with a list of up to 150 most recent cases.

3. Use the navigation keys to select **Select Cases** then press the **Select** button (). The highlight moves to the list of available cases to transfer.
4. Select up to 15 cases to include in the transfer by using the up and down navigation arrows to highlight a case then pressing the **Select** button (). A case is selected for inclusion in the disclosure log transfer when a check mark displays to the left of the case. The **Number of Cases Selected** field indicates the number of cases currently selected.
5. When you are done selecting cases, press the **Home/Display** button (). The highlight moves to the **Transfer** key.
6. With the **Transfer** key highlighted, press the **Select** button (). The Disclosure Log Transfer dialog displays indicating the transfer progress.

If the Disclosure Log Transfer Failure dialog box displays, use the navigation keys to select **Retry** then press the **Select** button (). The X Series continues the transfer from the case that failed. Otherwise, if you would like to end the transfer use the navigation keys to select **Cancel** then press the **Select** button () to return to the Primary Display window.

7. When the Disclosure Log Transfer Complete dialog box displays select **OK** to return to the Primary Display window.

# Supervisor Communications Menu

## Overview

The Communications menu is located in the Supervisor Setup menu. The Supervisor function is restricted and requires password access.

In the Communications menu, you can setup:

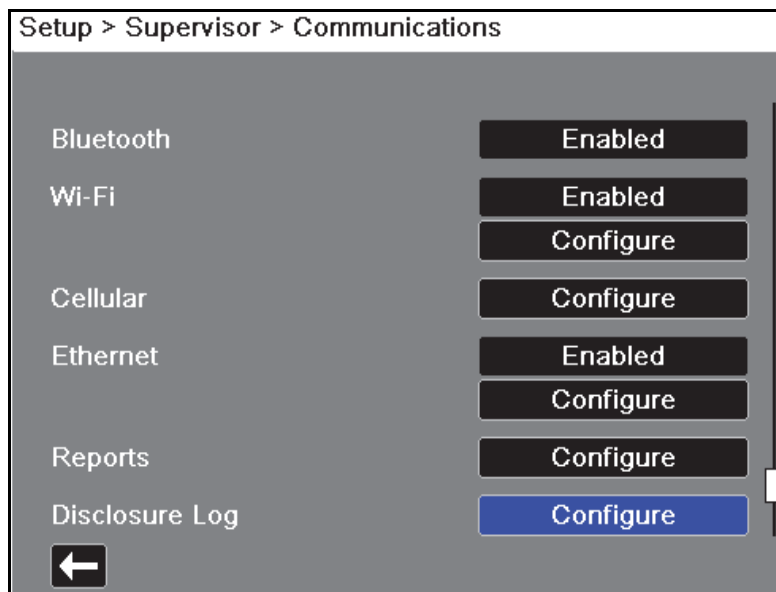
- Wi-Fi access points.
- Bluetooth pairings (DUN or PAN-NAP profiles only).
- Cellular provider information for use with USB cellular modems.
- An Ethernet connection.
- 12-lead report settings and set up distribution lists for 12-lead and full disclosure reports.
- Disclosure Log transfer settings.
- A password necessary for clients to access the X Series device.
- Clock Synchronization settings.

**Note:** Communications setup is not available in AED mode.

## Accessing the Communications Menu

To access the Communications menu:

1. Press the More quick access key (➤).
2. Press the Setup quick access key (⚙️). Use the navigation keys to scroll down to **Supervisor**. Press (⏪).
3. Enter the password. The Supervisor menu appears.
4. Use the navigation keys to highlight and select **Communications**. The options for Communications are displayed.



**Wireless**

Use the navigation keys to enable or disable this function. When disabled, all internal wireless capabilities are disabled in the X Series unit.

**Bluetooth**

Use the navigation keys to enable or disable this function. When disabled, all Bluetooth capabilities are disabled in the X Series unit.

**Wi-Fi**

Use the navigation keys to enable or disable this function, and to configure access point profiles. When disabled, all internal Wi-Fi capabilities are disabled in the X Series unit. See “Wi-Fi Access Point Profiles” on page 22-16.

**Cellular**

Use the navigation keys to configure USB cellular modem or Bluetooth devices. See “Setting up Cellular Communications” on page 22-23.

**Ethernet**

Use the navigation keys to enable or disable Ethernet capability. See “Setting up an Ethernet Connection” on page 22-28 for configuring your Ethernet connection.

**12-Lead Reports**

Storage and management of 12-lead reports and full disclosure case files on the X Series unit can be managed from third-party software such as ZOLL RescueNet. In this menu you can configure the ZOLL server, and view or update distribution lists. See “Configuring 12-Lead Report Transmissions” on page 22-29.

**Disclosure Log**

The X Series unit allows you to send the Disclosure Logs and audio for up to 15 cases at one time to a remote server. Use the Disclosure Log menu to configure the server to which to send the log data. See “Configuring Disclosure Log Transmissions” on page 22-30.

**Data Services**

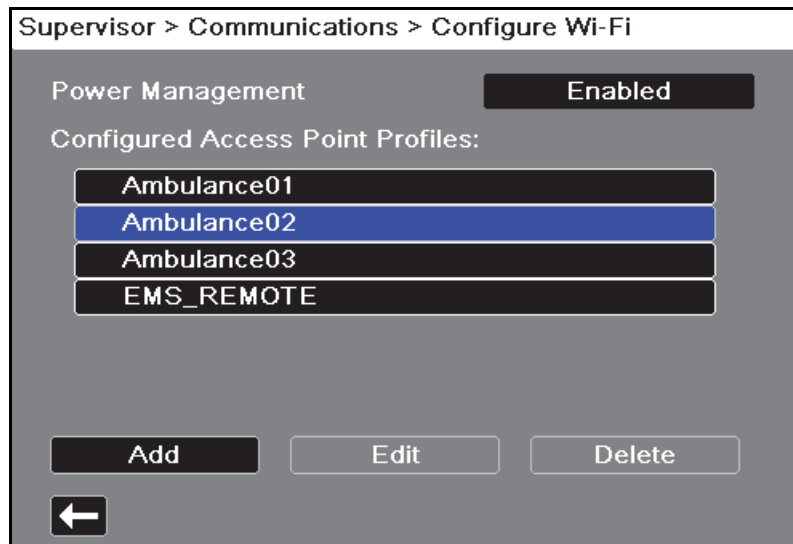
The X Series unit allows you to set up a password that clients must use to access the X Series unit. See “Data Services” on page 22-32.

**Clock Sync**

Use the navigation keys to configure Clock Synchronization. The Clock Synchronization feature allows you to synchronize the X Series unit’s internal real time clock to an external reference time source using Simple Network Time Protocol. See “Configuring Clock Synchronization” on page 22-34.

## Wi-Fi Access Point Profiles

To select and modify Wi-Fi Access Point Profiles, use the navigation keys to highlight and select **Configure Wi-Fi**.



A green check mark indicates the selected access point. Use the navigation keys to select a different profile, or to add, edit or delete other profiles.

**Note:** Selecting a profile in this list allows you to edit or delete the profile. It does not make a profile the active Wi-Fi profile selection. See “Selecting a Pre-Configured Access Point Profile” on page 22-5 for information on making a Wi-Fi profile active.

The Power Management option allows you to enable or disable Wi-Fi power management. The Power Management option is enabled by default.

To add a new Access Point Profile:

Use the navigation keys to highlight and select **Add**. You can enter the type of network setting, profile name, SSID, authentication, and security key.

Communications > Configure Wi-Fi > Edit AP Profile

Profile Name	Ambulance02
Network Setting	DHCP
	Configure
SSID	MySSID
Non-broadcast SSID	Disabled
Authentication	WPA2-PSK
Security Key	MyNetworkKey

←

### Profile Name

Use the alphabetical keypad to enter the profile name. Press **SAVE** to save changes and return to the Wi-Fi configuration menu; press **Cancel** to return to the Wi-Fi configuration menu without saving changes.

Profile Name

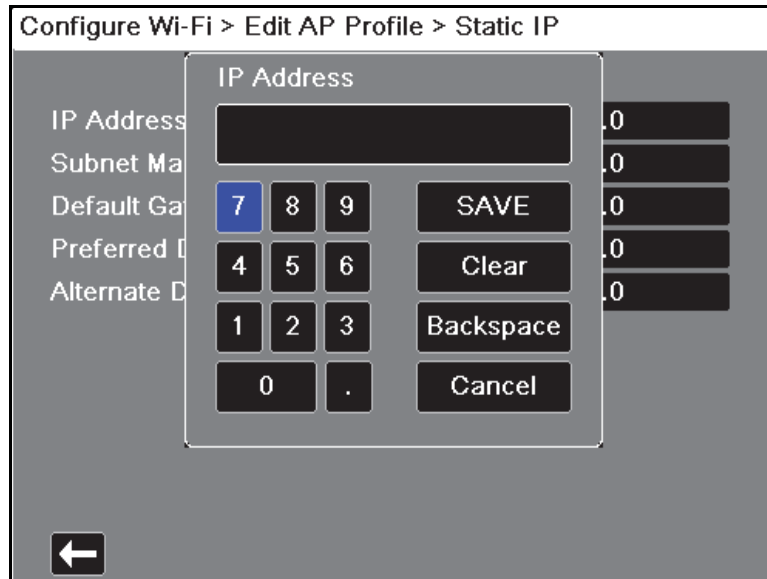
Ambulance01

A	B	C	D	E	F	G	H	I	
J	K	L	M	N	O	P	Q	R	
S	T	U	V	W	X	Y	Z		
Backspace					Clear				
0	1	2	3	4	5	6	7	8	9
.	-	#	*	/	@	&	,	'	_
\	!	?	\$	%	+	^	=	~	:
;	"	<	>	(	)				

SAVE Cancel

### Network Setting

Use the navigation keys to select either DHCP or Static IP. If you select Static IP, use the numeric keypad to enter values for the IP Address, Subnet Mask, Default Gateway, Preferred DNS Server, and Alternate DNS Server.



### SSID

Use the alphabetical keypad to enter the SSID name. Press **SAVE** to save changes and return to the Wi-Fi configuration menu; press **Cancel** to return to the Wi-Fi configuration menu without saving changes.



## Non-broadcast SSID

Use the navigation keys to enable or disable non-broadcast or hidden SSIDs. This must be set to Enabled to allow the X Series to connect to a Wi-Fi network that is configured not to broadcast its SSID.

## Authentication Protocol

Use the navigation keys to select the authentication type. The unit supports three types of Wi-Fi authentication:

- WPA-PSK (Wi-Fi Protected Access, Pre-shared key)
- WPA2-PSK (Wi-Fi Protected Access II, Pre-shared key)
- Enterprise

For WPA-PSK or WPA2-PSK, you are required to enter a security key (8-64 characters).

Communications > Configure Wi-Fi > Edit AP Profile

Profile Name	RSERIES
Network Setting	DHCP
	Configure
SSID	
Non-broadcast SSID	Disabled
Authentication	WPA-PSK
Security Key	

←

Use the alphabetical keypad to enter the security key. Press **SAVE** to save changes and return to the Temporary Profile menu; press **Cancel** to return to the Temporary Profile menu without saving changes.

Security Key

[Empty input field]

A	B	C	D	E	F	G	H	I	
J	K	L	M	N	O	P	Q	R	
S	T	U	V	W	X	Y	Z		
Backspace				Clear					
0	1	2	3	4	5	6	7	8	9
.	-	#	*	/	@	&	,	'	_
\	!	?	\$	%	+	^	=	~	:
;	"	<	>	(	)				
SAVE					Cancel				

### Configuring Enterprise authentication

Further configuration is required for Enterprise; use the navigation keys to select **Enterprise Settings Configure**. You will be asked for the Identity and Authentication Protocol (TLS or PEAP). Some fields will be greyed out, depending on the Authentication Protocol that you select.

Configure Wi-Fi > Add AP Profile > Enterprise Config

Identity	
Authentication Protocol	TLS
Password	None
Anonymous Identity	None
Client Certificate	None
Private Key Password	
Manage Client Certificates	
Load CA Certificate from USB	

←

#### PEAP (Protected Extensible Authentication Protocol)

If PEAP (Protected Extensible Authentication Protocol) is selected, you must enter the Password corresponding to the Identity entered. If the network requires it, you may enter an Anonymous Identity. Other options on the screen will be greyed out.

**Note:** The X Series unit only supports PEAPv0/v1 + MSCHAPV2.

#### TLS (Transport Layer Security)

If TLS is selected, you must select a Client Certificate and enter the Private Key Password corresponding to the private key in the Certificate file. Other options on the screen will be greyed out.



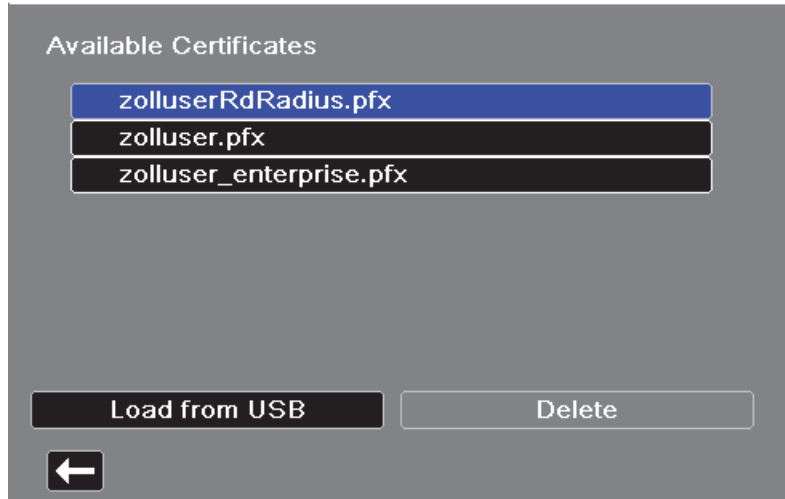
### TLS Client Certificates

For TLS client certificates, you can choose from a list of pre-loaded files.

To load a new certificate from a USB device:

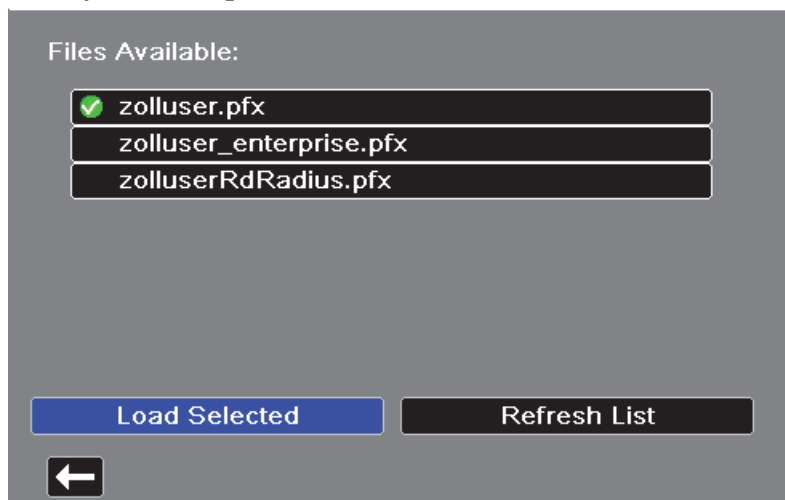
1. Select **Manage Client Certificates**. A list of existing certificates displays.

Add AP Profile > Enterprise Config > Client Certificates



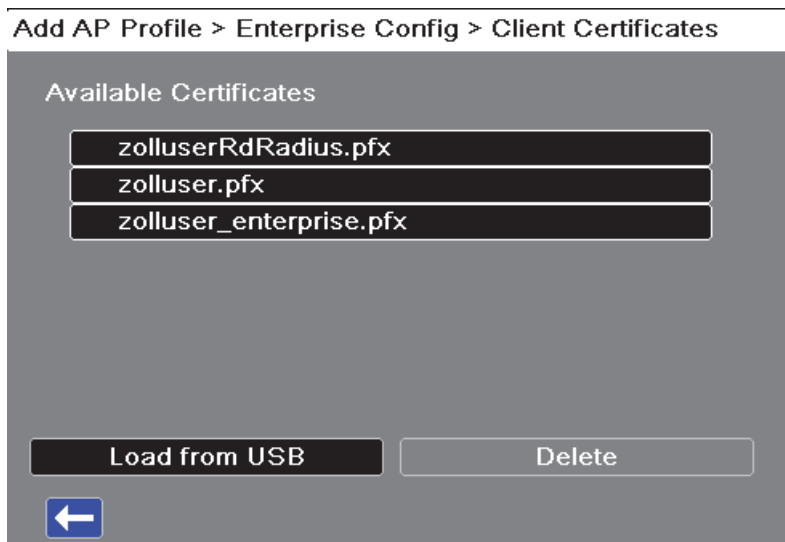
2. Select **Load from USB**. A list of files on the USB device displays. Filenames can only be 24 characters long. If the files on the USB device are more than 24 characters, then they will not appear on the X Series unit screen. The X Series unit only supports PFX format client certificates.
3. Use the arrow keys to select the desired file. Only one file can be selected at a time. If a new USB device has been inserted, select **Refresh List**.

Enterprise Config > Client Certificates > Load from USB



4. Select **Load Selected**. A confirmation box displays indicating the file has loaded. Select **OK**.

5. Press the back arrow (←) to view the list of all currently loaded certificates.



6. Press ← to return to the Enterprise Wi-fi Configuration menu, and ← again to return to the Add Access Point Profile menu.

### Organizations With Their Own CA

The X Series provides pre-loaded certificate files for common certificate authorities. For organizations that act as their own CA or use a CA that the X Series does not provide, the X Series unit allows you to load your own CA certificates. To load a new CA certificate:

1. Insert the USB device with the CA certificates into the USB port on the right side of the X Series unit.
2. Select **Load CA Certificate from USB**. A list of files on the USB device displays. The X Series supports PEM, DER, and P7B CA certificate formats.
3. Use the arrow keys to select the desired file then select **Load Selected**. Only one file can be selected at a time.
4. When the Certificate Loaded dialog box displays, select **OK** to confirm.
5. Press ← to return to the Enterprise Wi-fi Configuration menu, and ← again to return to the Add AP Profile menu.

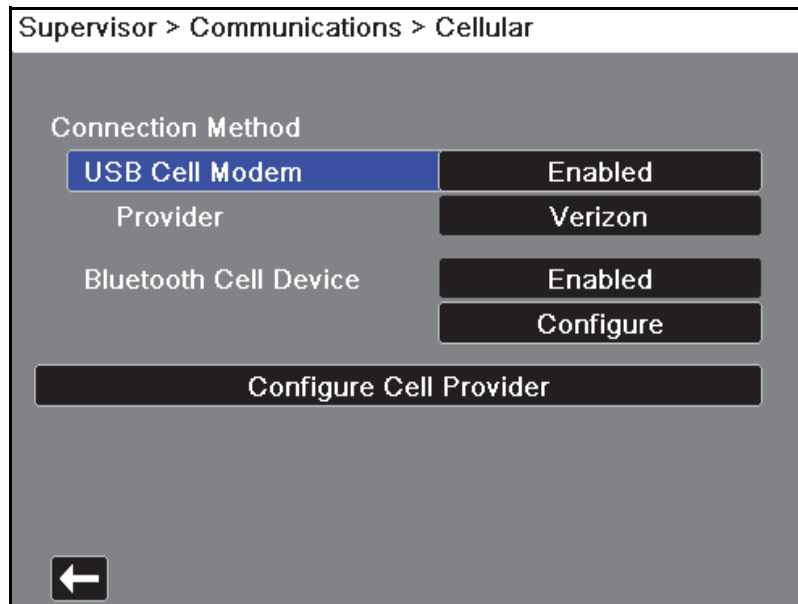
When finished editing your Wi-Fi profile, press the back arrow (←) to return to return to the list of configured access point profiles. From this menu you can also edit or delete existing profiles.

After deleting a file, be sure to review the defined Wi-Fi profiles and update any which referred to the deleted file.

Press ← to return to the Communications menu.

## Setting up Cellular Communications

You can configure your USB cellular modem or Bluetooth device to work with the X Series unit. Under the Communications menu, select **Cellular Configure**. The Cellular menu appears.



You can use the arrow keys to enable or disable all cellular functions, and configure your cell phone provider information.

### Configuring Cell Phone Provider Information

You can create up to three cell phone providers. Use the arrow keys to enter information about your cell phone provider:

- **Provider Name**

Provider name is an identifier you choose to refer to this cell phone provider.

- **Call Number**

Call number is an access number sometime referred to as a Dial String.

- **Account Name and Password**

Some providers require an account name and password. If your provider does not require these fields, leave them blank.

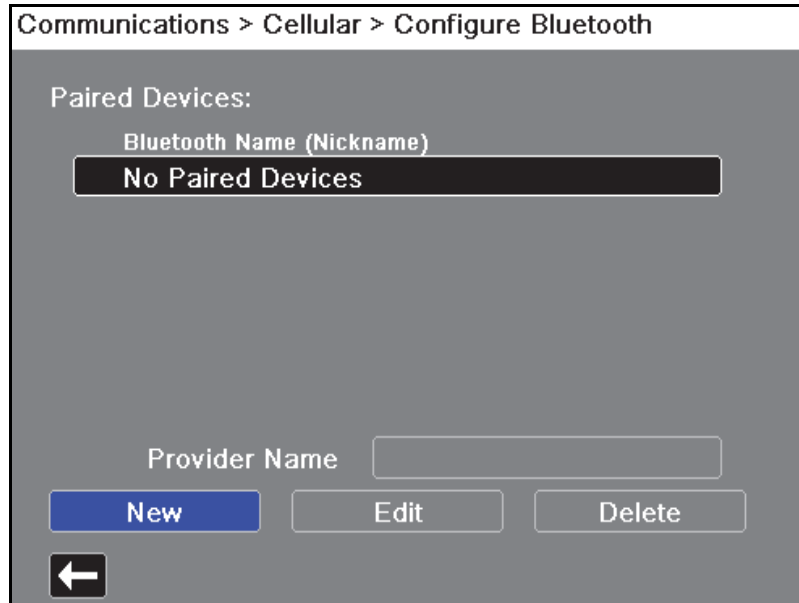
The screenshot shows a configuration screen titled "Communications > Cellular > Configure Cell Provider". Under the heading "Configured Cell Providers:", there is a list of two providers: "T Mobile" and "Verizon". The "Verizon" entry is selected and highlighted in blue, with a green checkmark to its left. Below the list are three input fields: "Call Number" (containing "#777"), "Account Name" (empty), and "Password" (empty). At the bottom of the screen are three buttons: "Add", "Edit", and "Delete". A back arrow icon is located in the bottom-left corner.

## Configuring and Pairing Bluetooth Devices

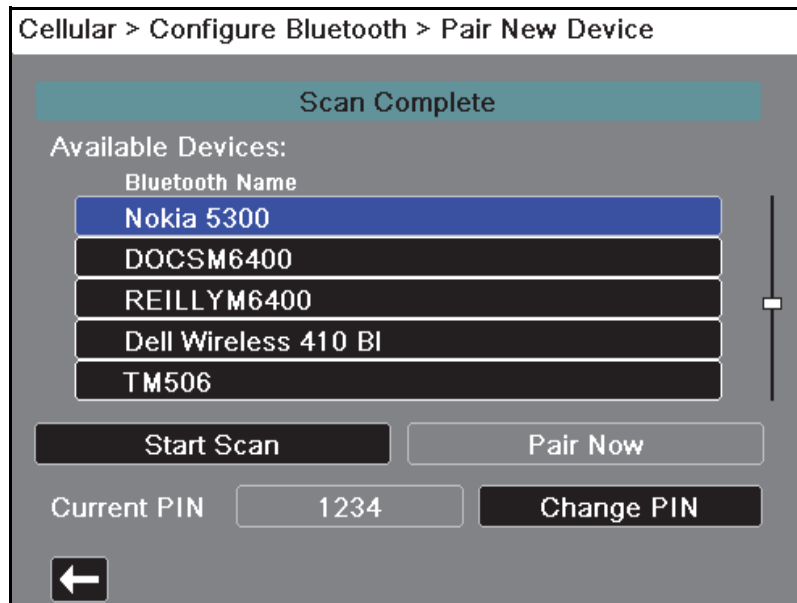
Bluetooth devices can also be paired from the main wireless menu, which does not require a password (see “Bluetooth Device Pairing” on page 10).

To pair Bluetooth devices, select **Bluetooth Cell Device Configure** in the Cellular menu.

To pair a new device, use the navigation keys and select **New**.

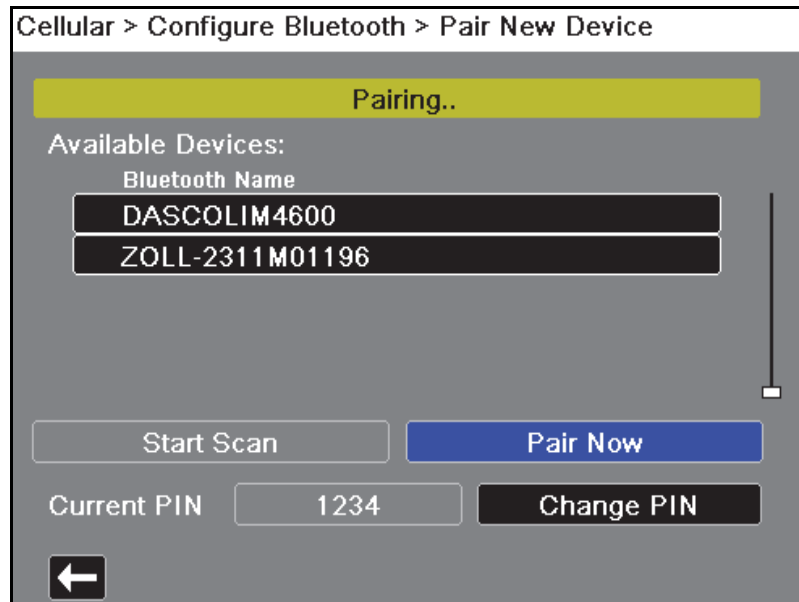


The unit will then scan for nearby Bluetooth devices that are in discoverable mode. Use the navigation keys to select the desired device; a green check mark indicates which device has been selected.

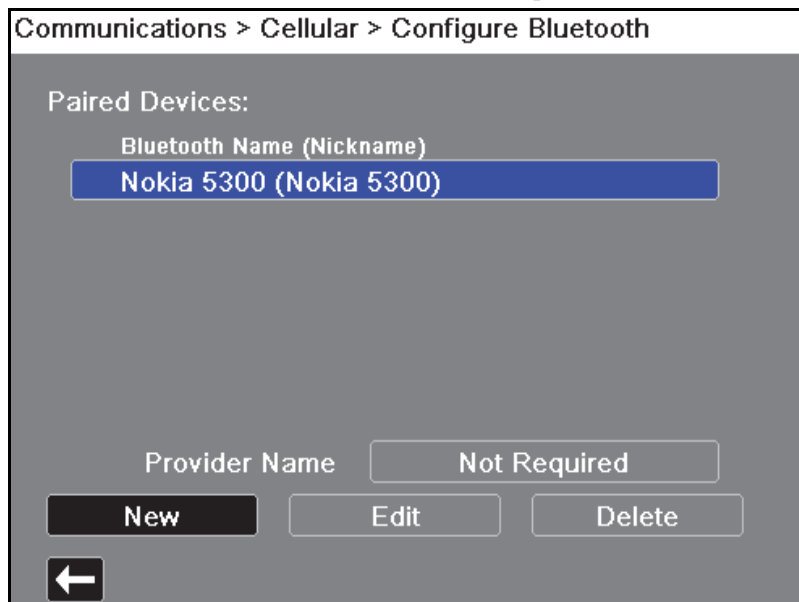


Select **Pair Now** to pair the device. On your Bluetooth device, accept the pairing request and enter the PIN, if prompted.

The unit then returns to the list of paired devices.

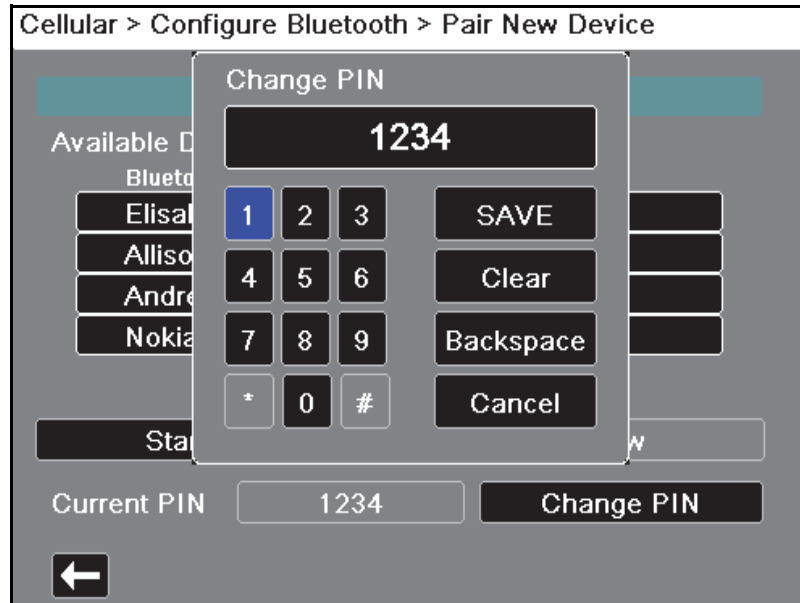


You can then edit the settings of the paired device, and give the device an optional nickname or set the provider. A provider is not required for Bluetooth devices using the PAN-NAP profile. Press the back arrow (←) to return to the list of paired devices.



**Note:** Use Bluetooth devices with DUN or PAN-NAP profiles only. Not all cellular phones transmit reliably; contact your local ZOLL Medical Corporation sales representative for a list of approved devices.

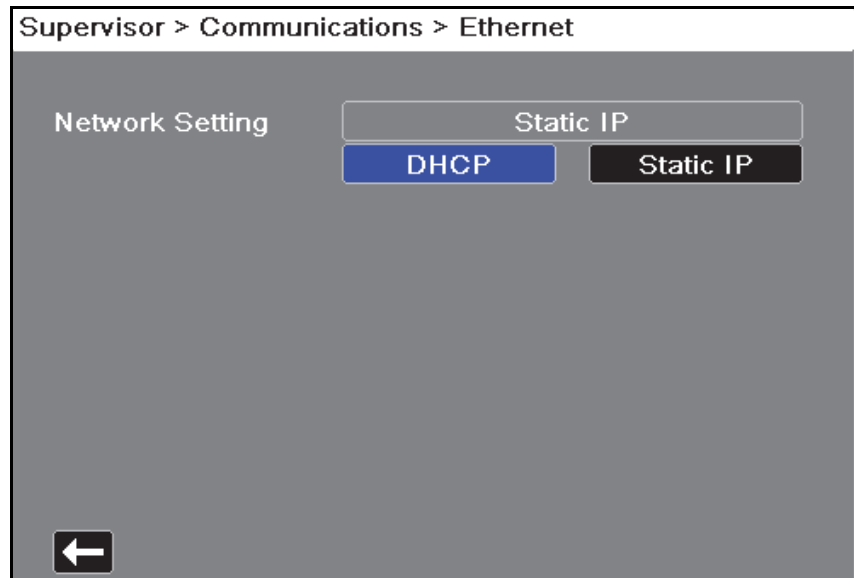
**Changing the PIN:** It may be necessary to change the PIN on the X Series unit; check your device's documentation. To change the PIN, select **Change Pin** in the Pair New Device menu, then use the numerical keypad to enter the desired PIN.



## Setting up an Ethernet Connection

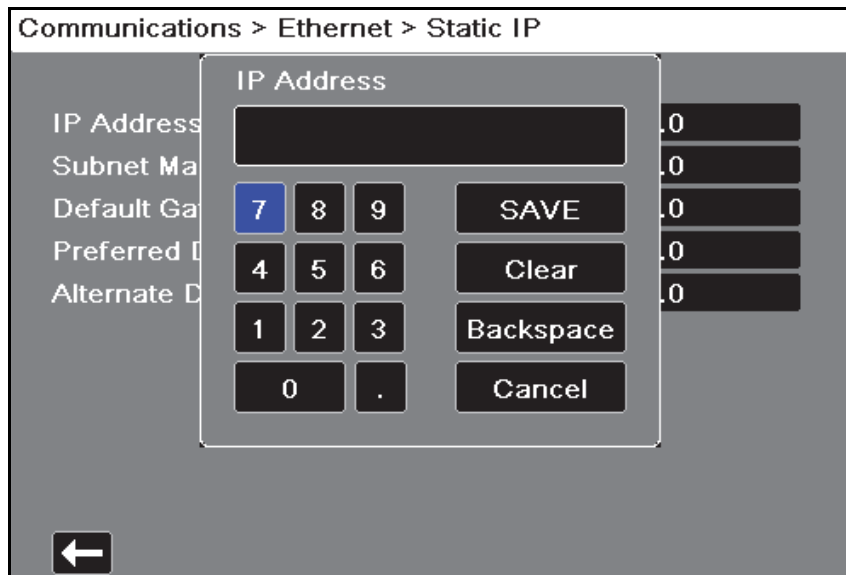
You can use an Ethernet adapter to transfer data to a PC via an Ethernet cable.

In the Communications menu, select **Ethernet Configure**.



Use the navigation keys to select either DHCP or Static IP. If you select Static IP, use the numeric keypad to enter values for the IP Address, Subnet Mask, Default Gateway, Preferred DNS Server, and Alternate DNS Server.

**Note:** If you are using an Ethernet adapter to transfer data to a PC, ZOLL recommends using the Static IP Address 169.254.1.250 and the Subnet Mask 169.254.1.250.





## Configuring 12-Lead Report Transmissions

The X Series unit can send 12-lead reports to the ZOLL RescueNet software. Distribution List entries defined in your RescueNet account specify possible report destinations, each of which consists of one or many recipients such as email addresses and fax machines. You must have a RescueNet account set up before you can complete configuration of the X Series device.

To configure 12-Lead reports transmissions:

1. In the Communications menu, select **Reports Configure**.

Supervisor > Communications > 12-Lead Reports

Server DNS Name	12subsvc.zollonline.com
Port	443
Password	MYPASSWORD
Customer ID	3115897
Verify Certificate	Enabled
View Distribution List	
Update Distribution List	
Load CA Certificate from USB	

←

2. Enter your RescueNet Customer ID and Password in the fields provided.
3. In the **Verify Certificate** field specify whether or not you want to Enable or Disable (default) certificate verification for the RescueNet 12-lead server. If the Verify Certificate field is set to Enabled, when the X Series establishes a connection to the RescueNet 12-Lead Server it verifies the server's certificate and identity before the 12 Lead transmission can proceed. If the verification fails, the X Series displays a status message indicating whether the failure was a result of certificate or identity validation. Enabling this option improves the security of the connection by confirming that the unit is communicating with the actual RescueNet server.

**Note**—The X Series comes with certificates file pre-loaded for common Certificate Authorities, including the CA used by the RescueNet server. All certificates, however, have expiration dates. It may be necessary to update the CA certificate in order to maintain the ability to successfully verify the RescueNet server's identity. Complete the following to update the CA certificate used to verify the RescueNet server:

- a. Insert a USB device with the certificates in the USB port on the right side of the X Series device.
- b. Select the **Load CA Certificate from USB** field. The **Load from USB** window displays with a list of available Root CA certificate files.
- c. In the **Files Available:** field select the desired certificate.
- d. Select **Load Selected** field. A list of files on the USB device displays.
- e. Use the arrow keys to select the desired certificate file then select **Load Selected**.
- f. Press **←** to return to the 12-Lead Reports menu,

- Before you can transmit 12-lead reports, you must download the current Distribution List for your account from the RescueNet server. If you have already configured your wireless preferences, you can use the **Update Distribution List** button to complete the download.

The X Series retains the current Distribution List until a new one is downloaded. If you modify the Distribution List entries using RescueNet, you should download a new copy to the X Series device.

- When you are done entering data, press the back arrow (←) to return to the Supervisor>Communications menu.

## Configuring Disclosure Log Transmissions

The X Series unit continuously stores information in a full disclosure case log for monitored patients. The X Series unit can maintain up to 150 full disclosure cases that contain:

- treatment events
- trends
- ECG and other continuous waveforms
- monitoring and event snapshots
- 12-lead snapshots and analysis.

For systems with a Disclosure Log server configured, the X Series unit allows you to wirelessly transmit the full Disclosure case logs and audio for up to 15 cases to a remote server for subsequent retrieval. Use the Supervisor>Communications>Disclosure Log menu to configure the remote server to which to send the disclosure log case data.

To configure the remote server:




- Under the Communications menu, select **Disclosure Log >Configure**. The Disclosure Log menu displays.

Supervisor > Communications > Disclosure Log

Server DNS Name	dxsvc.zollonline.com
Port	443
Password	
Customer ID	0
Verify Certificate	Enabled
Load CA Certificate from USB	

←

- In the Server DNS Name field, enter the host name of the remote server to which to send the Log data.
- Enter the **Port** to be used to connect to the server.
- Enter your associated **Password** and **Customer ID** in the fields provided.

5. In the **Verify Certificate** field specify whether or not you want to Enable or Disable (default) certificate verification for the RescueNet server. If the Verify Certificate field is set to Enabled, when the X Series establishes a connection to the RescueNet server it verifies the server's certificate and identity before the Disclosure Log transmission can proceed. If the verification fails, the X Series displays a status message indicating whether the failure was a result of certificate or identity validation. Enabling this option improves the security of the connection by confirming that the unit is communicating with the actual RescueNet server.  
*Note*—The X Series comes with certificates file pre-loaded for common Certificate Authorities, including the CA used by the RescueNet server. All certificates, however, have expiration dates. It may be necessary to update the CA certificate in order to maintain the ability to successfully verify the RescueNet server's identity. Complete the following to update the CA certificate used to verify the RescueNet server:
  - a. Insert a USB device with the certificates in the USB port on the right side of the X Series device.
  - b. Select the **Load CA Certificate from USB** field. The **Load from USB** window displays with a list of available Root CA certificate files.
  - c. In the **Files Available:** field select the desired certificate.
  - d. Select **Load Selected** field. A list of files on the USB device displays.
  - e. Use the arrow keys to select the desired certificate file then select **Load Selected**.
  - f. Press  to return to the Disclosure Log menu,
6. When you are done entering data, press the back arrow () to return to the Supervisor>Communications menu or press or the Home/Display button () to Primary Display window.

## Data Services

The Data Services parameter allows you to set the password necessary for clients to use to access the X Series device. From the Data Services menu you can:

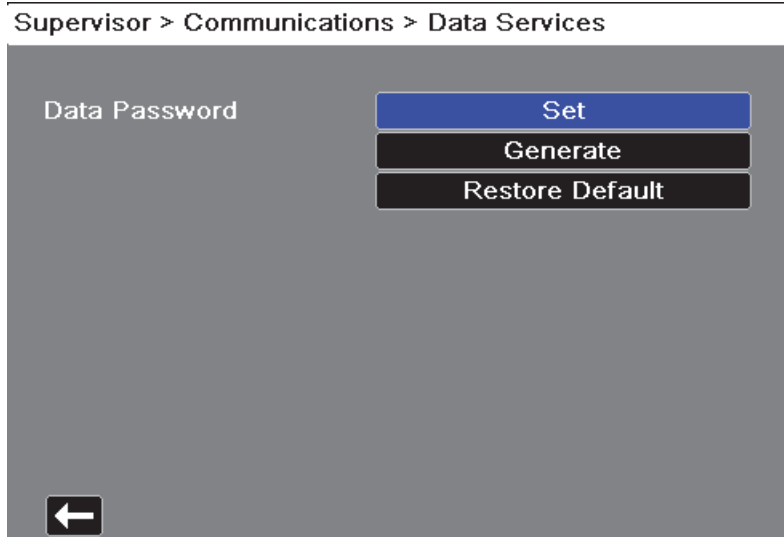
- Set your own password.
- Automatically generate password.
- Reset current password back to the default.

*Important*—For security ZOLL recommends setting your own password. When you set your own password you need to configure the same password in the ePCR software. Be sure the password you choose is sufficiently strong. Consider the following recommendations when setting passwords:


- Use a minimum of 16 characters.
- Use one uppercase and one lowercase character.
- Use one special character or example, !#\$%.
- Avoid patterns and character repetitions.
- Avoid common phrases or words associated with your institution.
- Avoid common passwords such as email and computer login passwords.
- Generate random passwords whenever possible.

To configure passwords:

1. Under the Communications menu, select **Data Services > Configure**. The Data Services menu displays.



2. If you would like to create your own password:
  - a. Select the **Set** field. The Password menu displays.
  - b. Use the alphabetical keypad and quick access keys to specify a password of at least 8 characters in length. Be sure to make the password you supply is sufficiently strong.
  - c. Press **SAVE**. You can press **Cancel** to return to the Data Services menu without saving changes.
3. If you would like to have the X Series automatically generate a password for you:

- a. Select the **Generate** field. The Password menu displays with a random password included.
  - b. Modify the password, if desired. Passwords must be at least 8 characters long. Be sure to make the password you supply is sufficiently strong. See password recommendations above.
  - c. Select **Save**.
4. If you would like to restore the password to its default:
    - a. Select the **Restore Default** field.
    - b. On the confirmation dialog box that displays, select **OK**.
  5. When you are done with the Data Services menu press  to return to the Supervisor Communications menu,

## Configuring Clock Synchronization

The Clock Synchronization feature allows you to synchronize the X Series unit's internal real time clock to an external reference time source using Simple Network Time Protocol (SNTP). SNTP servers provide Coordinated Universal Time (UTC) which is the primary time standard by which the world regulates clocks and time. In order to convert this standard time to the local time, the X Series allows you to configure a timezone offset. A timezone offset is the difference in hours and quarter-hours from UTC time for a particular locale. The timezone offset is a positive number if the local timezone is ahead of UTC and a negative number if it is behind. Additionally, for locations that observe Daylight Saving Time, the X Series provides a setting that, when set to On, immediately applies an additional 1-hour positive offset from UTC. The supervisor sets the initial value and the operator may subsequently toggle Daylight Saving Time on or off as necessary on the Set Date and Time screen (see "Setting the Date and Time" on page 2-20).

When Clock Sync is enabled and a network connection is available, the X Series unit automatically acquires a reference time from the SNTP server and converts the reference time to local time. The X Series will acquire a reference time from the SNTP server if no reference time has been acquired since the unit was powered on or the Clock Sync configuration settings have been changed. To ensure that the real time clock never changes during patient treatments, the X Series will make adjustments to its clock, if necessary, after the unit has been off for at least two minutes and prior to the start of a new case.

When Clock Sync is enabled, you can see the time of the last synchronization on the Set Date and Time screen. The X Series also provides the message *Clock Synchronization Failed* when an attempt at synchronization fails after the SNTP server settings have changed or if there has been no successful synchronization for 1 week or more. See "Setting the Date and Time" on page 2-20 for information on using the Set Date and Time screen.

To configure clock synchronization:

1. Under the Communications menu, select **Clock Sync > Configure**. The Clock Synchronization menu displays.

Supervisor > Communications > Clock Sync	
Clock Sync	SNTP
Time Server Name	TIME.EXAMPLE.COM
Time Server Port	123
Daylight Saving Time	Off
Time Zone Offset Hours	00
Time Zone Offset Mins.	00

2. In the **Clock Sync** field, specify whether or not to synchronize the X Series internal real time clock to an external time source.
  - Select **SNTP** if you would like to synchronize the X Series clock to an external time source.
  - Select **None** (default) if you do not wish to synchronize the X Series internal real time clock to an external source.
3. In the **Time Server Name** field, specify the time server to use for clock synchronization by either entering the host name or an IPv4 address for the server.
4. In the **Time Server Port** field, enter a numeric UDP port number for connecting to the external server. The default is 123.
5. In the Daylight Saving Time field, indicate whether to use Daylight Saving Time or not by selecting **On** or **Off** (default) as appropriate. Adjustments to Daylight Saving Time take effect immediately and must be manually adjusted at every transition between Standard Time and Daylight Saving Time. The Daylight Saving Time offset is zero if Daylight Saving Time is set to **Off** and 60 minutes if Daylight Saving Time is set to **On**.
 

**Note:** UTC time is a constant reference time. It does not change to reflect Daylight Saving Time or Summer Time. The Daylight Saving Time field allows you to accommodate locales that observe Daylight Saving Time or Summer Time. So, for example, UTC is 5 hours ahead of local time on the east coast of the United States during winter, but 4 hours ahead during summer.
6. Indicate the time zone offset value to use for your particular locale in the **Time Zone Offset Hours** (default 0) and **Time Zone Offset Mins.** (default 0) fields as appropriate.

When you are done entering data, press the back arrow (←) to return to the Supervisor > Communications menu. When changes are made on the Clock Sync menu the X Series attempts to synchronize its time if a network connection is available. To ensure the real time clock never changes during patient treatments, any necessary clock synchronization corrections will not occur, however, until the unit has been off for at least two minutes and prior to the start of a new case.

## Communications System Messages

The X Series unit may display one of the following status messages during the transmission:



<b>System Message</b>	<b>Cause</b>
<i>TRYING TO CONNECT TO NETWORK</i>	The unit is connecting to the network.
<i>TRANSMITTING</i>	The data transfer is in progress
<i>TRANSMISSION COMPLETE</i>	The data transfer is complete.
<i>TRANSMISSION FAILED</i>	<p>The data transfer has failed.</p> <p>To correct the problem, check the following:</p> <ul style="list-style-type: none"> <li>• Verify that wireless communications is enabled on your X Series unit.</li> <li>• Verify that the Wi-Fi settings are correct in the Communications setup menu.</li> <li>• Verify that the ZOLL server is configured correctly.</li> <li>• Verify that your cellular device is configured correctly.</li> <li>• Make sure that the X Series unit is within range of the wireless server.</li> </ul>
<i>INVALID CERTIFICATE FAILURE</i>	The certificate is expired or the trust chain cannot be established.
<i>HOSTNAME MISMATCH</i>	The certificate common name does not match the host name for the server to which you are trying to connect. The server host name and the certificate common name must match exactly. For example, if the server host name is "12lsubsvc.zollonline.com" then the common name must be "12lsubsvc.zollonline.com". The X Series allows you to use wildcards. So, for the example above, you could use the wildcard "*.zollonline.com".



---

## Transmission Status Icons

If you have attempted to transmit a snapshot or case disclosure logs, the snapshot list in the 12 Lead Review window or the case list in the Case Selection window, displays an icon to the left of the snapshot or case indicating the status of that transmission:

Icon	Transmission Status
	Indicates that a successful transmission has occurred.
	Indicates that <i>no</i> successful transmission has occurred.



# Chapter 23

## Printing

---

This chapter describes procedures for printing permanent records of pertinent patient care data and events.

---

**WARNING!** To avoid risk of electrical shock, do not touch the patient and internal parts of the printer simultaneously while the printer door is open.



---

### Printing Patient Data



The printing option allows you to print the following patient information:

- Waveforms
- Reports
- Trends

**Note:** A date that contains question marks (??/??/??) indicates that the X Series was not able to determine the date and time on power up. Power cycling the unit may correct the problem. If the problem persists, set the date and time by highlighting the **Date and Time** display field and pressing Select.



**Note:** The Print quick access key () is highlighted with a blue background while the printer is printing. Pressing  when it is highlighted stops the current printer activity.

## Printer Setup

To configure the printer functions, press the More quick access key () , press the Setup quick access key () , highlight **Printer**, and press Select. Use the navigation keys to select the desired print configuration. The Setup>Printer window contains the following print configuration options:


Print configuration	Options
Print Speed	25 mm or 50 mm per second
Print Number of Traces	1, 2, 3, or 4
Print Grid	On or Off
Print on Snapshot	On or Off
Print on Patient Alarm	On or Off
Print on NIBP	On or Off
Print on Trend	On or Off

## Automatic Prints

You can print any following events by setting the monitor to print automatically in the Setup>Supervisor>Printer window. To do this, press () , then press  . Using the navigation buttons, select **Supervisor**, and then **Printer**.

- Defib/Pacer Events
- Event
- Treatment Snapshot
- Treatment Summary Snapshots

## Printing Waveforms

You can print waveforms by pressing  . The X Series unit will print the displayed waveforms as configured in the Number of Traces option. The Print Number of Traces option can be set to **1**, **2**, or **3**. Patient vital sign numerics are printed above the waveforms.

**Note:** Waveforms that have invalid data print a dashed line for that trace.

### The ECG Waveform

ECG waveforms are printed on a grid with major divisions (dotted lines) every 5mm and minor divisions (single dots) every 1 mm. The ECG waveform is always printed if ECG is monitored.

### The Invasive Pressure Waveform

Pressure waveforms are printed on a grid with major divisions (vertical dotted lines) every 5 mm, and the pressure scale grids are printed horizontally.

### The SpO<sub>2</sub> Plethysmograph

The SpO<sub>2</sub> plethysmograph is printed with major divisions (vertical dotted lines) every 5 mm.

### CO<sub>2</sub> Waveform

CO<sub>2</sub> waveforms are printed on a grid with major divisions (vertical dotted lines) every 5 mm, and the pressure scale grids are printed horizontally.

### RESP Waveform

Respiration waveforms are printed with major divisions (vertical dotted lines) every 5 mm.

## Printing Reports

### Print on Snapshot

Prints snapshot, including numerics and waveform each time a snapshot is acquired.

### Print on Patient Alarm

You can print a report each time an alarm occurs. This report is called the Print on Patient Alarm Report. The **Print on Patient Alarm** setting must be turned on in the Setup>Print window.

### Print on NIBP




You can print the results of an NIBP measurement each time one occurs. This report is called the NIBP Ticket Report. The **Print on NIBP** setting must be turned on in the Setup>Print window.

### Print on Trend

Prints numeric trend values each time a trend data snapshot is taken.

### Printing Treatment Summary Report

To print a treatment summary report, do the following:

1. Press the More quick access key (.
2. Press the Log quick access key (.
3. Press the Treatment Summary quick access key (). The Treatment Summary window displays.
4. Use the navigation keys to highlight and select the treatment summary you want to print.

**Note:** The Treatment Summary Report that you selected has a check mark next to it.


5. Use the navigation keys to highlight and select **Print Treatment Summary**.

## Printing Trends

Printed trends are useful for reviewing the patient's vital signs over the last several minutes to the last five hours. The X Series unit enables you to print vital signs data at one selected time or a trend summary showing vital signs values acquired during the current case (up to the last 24 hours).


### Printing Trend Summary

Follow the steps below:

1. Press the **Display/Home** button (  ) to display the Trends window.
1. Use the navigation keys to highlight **Trends** field and press **Select**. The Trend Settings menu displays.
2. Highlight **Print Trend Summary** and press **Select**. The Trend Summary Report begins printing and Print Summary field changes to **Cancel Report**.
3. To cancel the report, highlight **Cancel Report** and press **Select**.



### Printing Individual Trend Snapshots

Follow the steps below:

1. Press the **Display/Home** button (  ) to display the Trends window.
2. Highlight the **Navigate here to scroll through trends** field at the bottom of the Trends window, then press **Select**.
3. Using the navigation keys, select the trend snapshot you want to print and press **Select**.
4. Highlight the **Print this Trend** field and press **Select**. The trend snapshot begins printing.

### Printing Trend Data for Current or Older Cases

You can print a trend summary for one or more cases by doing the following:

1. Press the **Log** quick access key (  ) then press **Print Trends** (  ). The Trend Summary menu displays.
2. Use the navigation keys to select the case or cases you want to print.
3. Press **Select**. The case(s) appears with a check mark.
4. Highlight the **Print Trend Summary** field and press **Select**. The trend data for all the selected cases begins printing.

# Chapter 24

## Maintenance

---

Resuscitation equipment must be maintained to be ready for immediate use. To ensure the readiness and optimum working condition of the X Series unit, you should perform the following inspections and tests daily or at each shift change.

In addition to the daily check, authorized personnel should complete performance and calibration testing at regularly scheduled intervals, which should not exceed one year.

A maintenance log is an important part of a successful maintenance program in which you record information on a regular basis. This allows for verification of necessary maintenance and for scheduling periodic requirements such as calibration and certification.

In accordance with the recommendations of the Defibrillator Working Group of the Food and Drug Administration, an operator's shift check list is included in this chapter, which you can copy for use as needed.

# Daily/Shift Check Procedure

## Inspection

### Equipment and Accessories

- Ensure that the X Series unit is clean (with no fluid spills) and free of visible damage.
- Inspect all cables, cords, and connectors for signs of damage or excessive wear (cuts in insulation, fraying, broken wires, dirty or bent connector pins). Replace if damaged.
- Inspect the battery, ECG patient cable, multifunction cable (MFC), OneStep cable, pulse oximetry sensor, blood pressure cuff, and hose and temperature sensors for signs of damage or excessive wear. Replace if damaged.
- Inspect the defibrillator paddles for damage or excessive wear. Check that paddle surfaces are clean and free of electrolyte gel or other contaminants. Verify that all paddle controls operate freely when pressed and released.
- Inspect the external AC adapter and its power cords for signs of damage. Replace if damaged.

### Supplies

- Verify the presence, proper condition, and appropriate quantities of all disposable supplies (hands-free therapy electrodes, ECG monitoring electrodes, defibrillator gel, recorder paper, alcohol swabs, razors/scissors, etc.).
- Verify that two sets of hands-free therapy pads are available.
- Ensure that the therapy and monitoring electrodes are sealed within the packages and within the expiration dates printed on the packages.
- Open the recorder door on the left side of the X Series unit and verify that an adequate supply of paper is available in the unit.

### Batteries

- Verify that a charged battery is fully inserted into the battery compartment of the X Series unit.
- Ensure that a fully charged spare battery pack is available.

### Ready For Use Indicator

- Check the Ready For Use (RFU) indicator on the X Series front panel. Verify that the RFU symbol is displayed.

If the RFU indicator is flashing or displaying the Do Not Use symbol, then either an equipment fault has been detected or the unit's battery is low or not properly installed. Install a fully charged battery in the unit and check the RFU indicator again. If the RFU indicator continues to flash or display the Do Not Use symbol, remove the unit from service and contact the appropriate technical personnel or the ZOLL Technical Service Department.





## Defibrillator/Pacing Test with Hands-Free Therapy Electrodes

**Note:** If a low battery message appears during any of this testing, the battery is close to depletion and should be replaced or recharged.

**Warning!** Keep hands, fingers, and other conductive materials away from paddle electrode plates when discharging the defibrillator, or pacing.

	Function	Response
1	Connect the external AC adapter to a working AC outlet and to the X Series rear panel.	Verify that the green Auxiliary Power LED illuminates on the X Series front panel.
2	Insert a battery into the unit (if a battery is not already in the slot).	Verify that the Battery Charge LED on the X Series front panel illuminates yellow. When the battery pack has been fully charged, the battery status indicator light is green.
3	Press the unit's power on switch.	<p>Verify the unit issues two audio beeps and that the red, yellow, and green Visual Alarm indicators illuminate for 2 to 3 seconds.</p> <p><b>Note:</b> The yellow LED may remain lit after the unit powers on.</p> <p>The X Series unit performs a number of power on self tests.</p> <p>Verify that the unit displays <i>SELF TEST PASSED</i>.</p> <p>If the message <i>SELF TEST FAILED</i> appears on the display, contact the appropriate technical personnel or the ZOLL Technical Service Department.</p>
4	Disconnect the external AC adapter from the X Series rear panel.	<p>Verify that the unit continues to operate without interruption on battery power and that the displayed battery icon indicates that a fully charged battery is installed.</p> <p>Verify that no error messages are displayed.</p>
5	With no ECG cables attached to the unit, select Lead I, II, or III as the waveform display source.	Verify that a <i>LEAD FAULT</i> message displays in the waveform window.
6	Select <b>Pads</b> as the waveform display source and connect the multifunction cable to the unit. (Do not connect the test connector to the MFC.)	Verify that a <i>CHECK THERAPY ELECTRODES</i> message displays in the waveform window.
7	<p>Connect the multi-function cable (MFC) to the test connector.</p> <p>Alternatively, connect a OneStep MFC and a shorted OneStep pad.</p>	Verify that the <i>CHECK THERAPY ELECTRODES</i> message is replaced by a <i>SHORT DETECTED</i> message.

	Function	Response
8	Press the Select Energy arrow (up or down).	Verify that the defibrillation window displays and the following message appears: <i>PADS SHORT DETECTED</i> <i>SELECT 30J TO TEST</i>
9	Press the Select Energy arrow (up or down) to select 30 Joules on the X Series unit.	Verify that the defibrillator window shows 30 J as the selected energy.
10	Press the <b>CHARGE</b> button on the front panel.	Verify that a periodic tone sounds while the defibrillator is charging. At the completion of the charge cycle, the tone is continuous. The charge time should be less than 7 seconds.  Verify that the <b>SHOCK</b> button (  ) on the front panel illuminates when the defibrillator is charged.
11	Press and hold  on the front panel until the unit discharges.	Verify that the defibrillator discharges and that a <i>DEFIB SHORT TEST PASSED</i> message displays.  If the message <i>DEFIB SHORT TEST FAILED</i> displays, contact the appropriate technical personnel or the ZOLL Technical Service Department.
12	After the defibrillator display panel closes, press the <b>PACER</b> button on the front panel to display the Pacer Settings dialog box.	Verify that the Pacer Settings dialog displays with the pacer status bar behind it.
13	Perform the following steps: <ul style="list-style-type: none"> <li>• Set the Pacer mode to Fixed.</li> <li>• Set the Pacer Rate to 60 ppm.</li> <li>• Set the Output to 100 mA.</li> <li>• Select the Start Pacer button.</li> </ul>	Verify that the green pace indicator on the pacer status bar flashes once each second.  Verify that pace markers are printed every 25 mm on the chart recorder printout.  <b>Note:</b> If a printout does not automatically begin after starting the pacer, select the Print quick access key to start a continuous printout. Press the Print quick access key again to stop the printout.
14	Press the <b>PACER</b> button on the front panel button again to close the Pacer Settings dialog box.	Verify that the pacer status bar indicates <i>PACING: SHORT DETECTED</i> .  Verify that the green pace indicator continues to flash once each second.  Verify that no pacer-related error messages display.
15	Disconnect the test connector from the MFC or disconnect the OneStep pad from the OneStep MFC as appropriate.	Verify that the pacer status bar displays: <i>PACING: CHECK THERAPY ELECTRODES</i>
16	Press the <b>PACER</b> button on the front panel to display the Pacer Settings dialog. Select <b>Turn Pacer Off</b> to turn off the pacer.	Verify that the Pacer Settings dialog is closed and that the pacer status bar is removed from the display.
17	Reconnect the external AC Adapter to the X Series rear panel.	Verify that the green Auxiliary Power indicator light on the X Series front panel is illuminated.

## Defibrillator Testing with External Paddles

Prior to testing external defibrillator paddles with the X Series unit, complete the testing described in “Defibrillator/Pacing Test with Hands-Free Therapy Electrodes” on page 24-3.

**Note:** If a low battery message appears during any of this testing, the battery is close to depletion and should be replaced or recharged.

---

**Warning!** **Keep hands, fingers, and other conductive materials away from paddle electrode plates when discharging the defibrillator, or pacing.**

---

	Function	Response
1	Press the X Series power switch to turn the unit on.	Verify that the unit displays the <i>SELF TEST PASSED</i> message.
2	Connect the MFC to the defibrillator and disconnect the patient end of the MFC from any attached accessory (paddles or test connector). Select <b>Pads</b> as the waveform display source.	Verify that a <i>CHECK THERAPY ELECTRODES</i> message displays in the waveform window
3	Connect the paddles set to the X Series MFC cable. Do not place the paddles electrodes in contact with each other.	Verify that the <i>CHECK THERAPY ELECTRODES</i> message changes to <i>APPLY PADDLES TO PATIENT</i> .
4	Press the <b>RECORDER ON/OFF</b> button on the Sternum paddle.	Verify that the recorder begins printing.
5	Press the <b>RECORDER ON/OFF</b> button again.	Verify that the recorder stops printing.
6	Press the Apex and Sternum paddle electrodes together (face to face) maximizing the contact area between the electrodes.	Verify that the <i>APPLY PADDLES TO PATIENT</i> message changes to <i>SHORT DETECTED</i> .
7	Press the <b>ENERGY SELECT (+)</b> button on the Sternum paddle.	Verify that the defib window displays and the following message appears:  <i>PADDLE SHORT DETECTED</i>  <i>SELECT 30 J TO TEST</i>
8	Press the <b>ENERGY SELECT (+)</b> button again.	Verify that the selected energy increases to the next highest level.
9	Repeatedly press the <b>ENERGY SELECT (-)</b> button on the Sternum paddle until 30 Joules is selected.	Verify that the defibrillator window shows 30 J as the selected energy.
10	Press the <b>CHARGE</b> button on the Apex paddle. (Press the <b>CHARGE</b> button twice if the defibrillator window has disappeared.)	Verify that a periodic tone sounds while the defibrillator is charging. At the completion of the charge cycle, the tone is continuous. The charge time should be less than 7 seconds.  Verify that the <b>CHARGE</b> light on the Apex handle illuminates when the defibrillator is charged and ready to deliver energy.
11	While the defibrillator is charged, press the paddles electrodes together and then press and hold the <b>SHOCK</b> button on the Apex paddle (only).	Verify that the defibrillator does not discharge.

	<b>Function</b>	<b>Response</b>
12	While the defibrillator is still charged, press the paddles electrodes together then press and hold the <b>SHOCK</b> button on the Sternum paddle (only).	Verify that the defibrillator does not discharge.
13	While the defibrillator is charged, press the paddles electrodes together then simultaneously press and hold both the Apex and Sternum paddle <b>SHOCK</b> buttons.	Verify that the defibrillator discharges and that a <i>DEFIB SHORT TEST PASSED</i> message displays.  If the message <i>DEFIB SHORT TEST FAILED</i> displays, contact the appropriate technical personnel or the ZOLL Technical Service Department.

## Recommended Minimum Preventive Maintenance Schedule

Operational Tests should be performed at regular intervals. The Operational Tests augment the automated self-tests that the X Series unit performs to help ensure readiness. For more information, see the Operational Tests in the *X Series Service Manual*.

### Annually

In addition to Daily/Shift Check Procedure and Operational Tests, the following is recommended:

- Perform NIBP calibration check.
- Perform CO<sub>2</sub> calibration check.
- The NIBP and CO<sub>2</sub> calibration checks should be performed annually or according to local requirements (to be performed by a qualified Biomedical Equipment Technician (BMET)) as described in the *X Series Service Manual*.

## Guidelines for Maintaining Peak Battery Performance

- Each battery should be identified with a number or letter. An identification mark is useful in tracking battery performance.
- Keep extra batteries in the *SurePower* Charger Station where their status can be quickly determined. Illumination of the Ready light is the most positive indication of a fully charged battery.
- Always carry at least one fully charged spare battery. If no other source of back-up power is available, two spare batteries are advisable.
- Rotate spare batteries routinely. The charge level gradually diminishes in a battery after it is removed from the charger even if it is not used. Regular battery rotation helps to avoid incidents where a low battery condition is encountered because the battery has not been recharged or used in more than 30 days.
- Whenever possible, recharge a partially depleted battery. This can be accomplished following any incident that involves patient monitoring. It ensures maximum operating time for each use, without reliance on spares. The need for a spare can then serve as an alert when an aging battery fails to provide normal operating time.
- Keep discharged batteries separated from spare batteries that are charged. When removing a discharged battery from the monitor, never place it in the location intended to carry a charged spare.

---

**Caution** DO NOT leave X Series battery packs in a depleted state. Damage to the battery packs can occur if they are left in a depleted state for more than 14 days.

---

## Cleaning instructions

### Cleaning the X Series unit

To clean the X Series unit, use a nearly dry cloth containing one of the mild cleaning agents listed below. DO NOT allow cleaning agent or water to run into the crevices or connector openings at any time. Thoroughly wipe off any excess cleaning solution from the X Series unit with a dry cloth.

Always check monitor and connector opening for unusual wear, damage or dampness while cleaning.

Use only these recommended cleaning agents:

- Warm water
- Hydrogen peroxide solution
- Liquid soap
- Wex-cide<sup>®</sup>
- Windex<sup>®</sup>

**Never** use these cleaning agents:

- Butyl alcohol
- Denatured ethanol
- Freon
- Mild chlorine bleach solution
- Isopropyl alcohol
- Trichloroethane, trichloroethylene
- Acetone
- Vesphene II
- Enviroquat
- Staphene
- Misty
- Glutaraldehyde

### Cleaning the NIBP Blood Pressure Cuff

Clean the cuff with common hospital disinfectants, including Clorox<sup>®</sup> (1:10 solution), Isopropyl alcohol, Lysol<sup>®</sup> solution, PhisoHex<sup>®</sup>, Quatricide<sup>®</sup>, Virex<sup>®</sup> and Vesphene<sup>®</sup>. Wash gently with the solution, then rinse. DO NOT allow solution to enter cuff tubes. Allow the cuff and hose to completely dry before patient use.

### Cleaning SpO<sub>2</sub> Sensors

Clean the SpO<sub>2</sub> sensors with a cloth that has been slightly dampened with one of the recommended agents listed above. DO NOT submerge the probe or its connector in any liquids or cleaning agents. Thoroughly wipe off any excess cleaning solution with a dry cloth. Allow the sensor to completely dry before patient use.

## Cleaning Cables and Accessories

Cables, cuff tubing, paddles and other accessories can be wiped clean with a damp cloth moistened in a mild detergent solution.

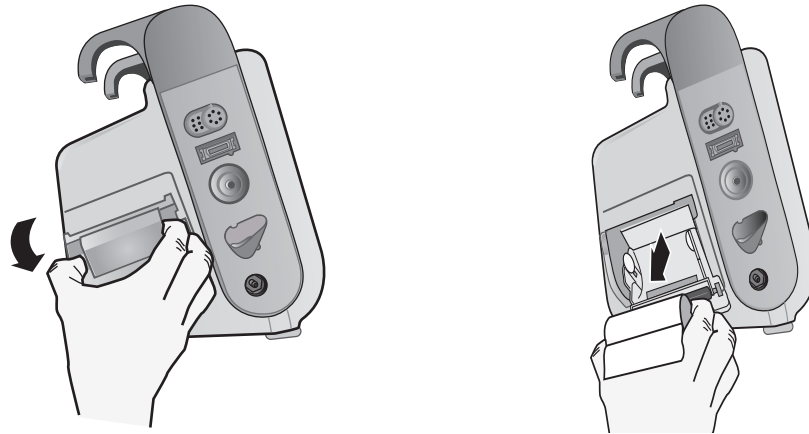
## Loading Recorder Paper

The unit displays the message *PRINTER OUT OF PAPER* when the printer is activated without recorder paper or if the supply runs out during printing.

Use ZOLL recorder paper (part number 8000-000901).

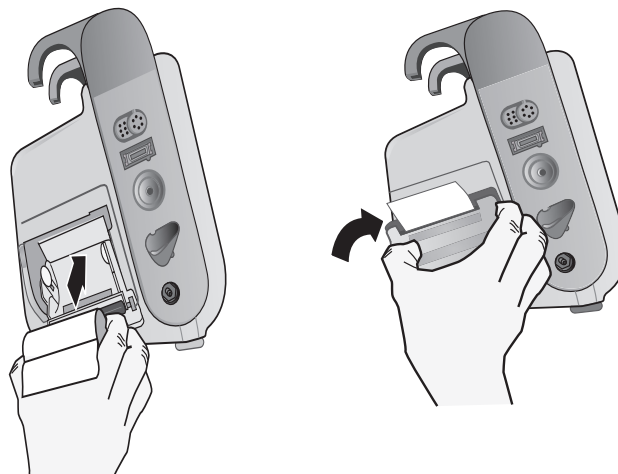
To load the recorder paper into the printer:

1. Insert your fingers into the indentations on the sides of the printer door, pull the door open, then remove any paper from the spool.




**Figure 24-1. Opening the Printer Door and Removing Paper**

2. Refer to the illustration inside of the paper compartment for proper paper orientation, and place a new roll of recorder paper on the empty spool.
3. Pull enough paper off the spool so that paper extends out of the unit when the printer cover is closed.
4. Close the printer door. Be sure the cover is flush with the side of the unit.



**Figure 24-2. Inserting the Paper and Closing Printer Door**

5. After the paper is loaded, press the Print quick access key (  ) to resume printing.

## Cleaning the Print Head

To clean the recorder print head, perform the following steps:

1. Pull the printer door open (see Fig. 24-1), then remove any paper.
2. Locate the print head along the front floor of the printer compartment.
3. Gently wipe the print head with a cotton swab moistened with isopropyl alcohol, and dry any residual alcohol with another dry cotton swab.



**Figure 24-3. Cleaning the Print Head**

4. Place the paper back into the unit and close the cover (see Fig. 24-2).



X Series OPERATOR'S SHIFT CHECKLIST

Date: \_\_\_\_\_ Shift: \_\_\_\_\_ Location: \_\_\_\_\_  
 Mfr/Model No.: \_\_\_\_\_ Serial No. or Facility ID No.: \_\_\_\_\_

At the beginning of each shift, inspect the unit. Indicate whether all requirements have been met.  
 Note any corrective actions taken. Sign the form.

	Okay as found	Corrective Action/Remarks
<b>1. Defibrillator Unit</b>		
Clean, no spills, and casing undamaged		
<b>2. Cables/Connectors</b>		
a. Inspect for damaged insulation, frayed/broken wires, or bent connector pins b. Connectors engage securely		
<b>3. Sensors</b> (pulse oximetry, NIBP cuff and hose, temperature sensors)		
a. Inspect for signs of damage or excessive wear b. Connectors engage securely		
<b>4. Paddles</b>		
a. Clean, not pitted, or damaged. b. Switches operate freely c. Cables and connectors free of damage and engage securely		
<b>5. Supplies and Accessories</b>		
a. Therapy pads in sealed pouches (2 sets, not expired) b. Defib gel or gel pads c. ECG monitoring electrodes d. Alcohol wipes e. Razors/scissors f. Recorder paper		
<b>6. Batteries</b>		
a. Fully charged battery installed in unit b. Fully charged spare battery available		
<b>7. Ready For Use Indicator shows Ready</b> - No flashing or Do Not Use symbol		
<b>8. Operational Checks</b>		
<b>A. Power Up Sequence</b>		
a. Battery charge and AC indicators illuminate with AC power b. Audio beeps heard and Visual Alarm indicators briefly illuminate c. Self Test passed		
<b>B. Hands Free Defibrillation (Test with only battery power)</b>		
a. <i>CHECK THERAPY ELECTRODES</i> and <i>PADS SHORT DETECTED</i> messages display b. Charge time < 7 seconds c. <i>DEFIB SHORT TEST</i> passed at 30 Joules		
<b>C. Pacer Test (Test with only battery power)</b>		
a. Printer prints Pace markers every 25 mm at 60 ppm b. <i>PACING: SHORT DETECTED</i> message displays-- no error messages at 100 mA c. <i>PACING: CHECK THERAPY ELECTRODES</i> message displays		
<b>D. Paddles</b>		
a. <i>APPLY PADDLES TO PATIENT</i> message displays when paddles are connected to MFC b. Paddle switches functional (Recorder, Energy Select, Charge, Shock) c. <i>DEFIB SHORT TEST</i> passed at 30 Joules		
<b>E. Reconnect Unit to AC Power</b>		
_____ Major problem(s) identified (OUT OF SERVICE)		

Signature \_\_\_\_\_



# Appendix A

# Specifications

---

This chapter provides specification information for the X Series Monitor/Defibrillator.

- “Defibrillator” on page A-2.
- “Monitor/Display” on page A-14
- “Impedance Pneumography” on page A-15
- “Alarms” on page A-16
- “Recorder” on page A-17
- “Battery” on page A-17
- “General” on page A-18
- “Pacer” on page A-19
- “CO2” on page A-19
- “Pulse Oximeter” on page A-20
- “Non-Invasive Blood Pressure” on page A-23
- “Invasive Pressures” on page A-24
- “Temperature” on page A-25
- “Clinical Trial Results for the Biphasic Waveform” on page A-26
- “Electromagnetic Compatibility Guidance and Manufacturer’s Declaration” on page A-32
- “ECG Analysis Algorithm Accuracy” on page A-38
- “Wireless Output Guidance and Manufacturer’s Declaration” on page A-43

## Defibrillator

### Charge Time:

- Less than 7 seconds with a new, fully charged battery (first 15 charges to 200 joules).
- For the sixteenth discharge at maximum energy, the charge time is less than 10 seconds. Depleted batteries result in a longer defibrillator charge time.
- Less than 15 seconds when operating without a battery, using AC power alone at 90% of the rated mains voltage.
- Less than 25 seconds from the initial power on, with a new, fully charged battery pack (depleted by up to fifteen 200 joule discharges) or when operating without a battery, using AC power alone at 90% of the rated mains voltage.

### Rhythm Analysis and Charge Time in AED Mode

- Less than 30 seconds with a new, fully charged battery (first 15 charges to 200 joules).
- For the sixteenth discharge at maximum energy, the analysis and charge time is less than 30 seconds. Depleted batteries result in a longer defibrillator charge time.
- Less than 30 seconds when operating without a battery, using AC power alone at 90% of the rated mains voltage.
- Less than 40 seconds from the initial power on, with a new, fully charged battery pack (depleted by up to fifteen 200 joule discharges) or when operating without a battery, using AC power alone at 90% of the rated mains voltage.

**Patient Impedance Range:** 10- 300 ohms

**Synchronized Mode:** Synchronizes defibrillator discharge to the patient's R wave. SYNC is indicated on the display with R wave markers above the ECG waveform on the screen and stripchart. When ECG is monitored by the device, meets the DF-80:2003 requirement of 60ms maximum time delay between the peak of the R wave and the delivery of energy.

Table A-1 shows the characteristics of the X Series Rectilinear Biphasic™ waveform when discharged into 25 ohm, 50 ohm, 100 ohm, 125 ohm, 150 ohm and 175 ohm loads at the maximum energy setting of 200 joules.

**Table A-1. X Series Rectilinear Biphasic Waveform Characteristics**

	200 J discharged into					
	25Ω	50Ω	100Ω	125Ω	150Ω	175Ω
<b>First phase</b>						
Maximum initial current	31.4 A	30.4 A	19.7 A	19.4 A	16.7 A	15.6 A
Average current	27.1 A	24.9 A	17.5 A	16.2 A	14.4 A	13.2 A
Duration	6 ms	6 ms	6 ms	6 ms	6 ms	6 ms
<b>Interphase duration</b> (between first and second phases)						
	200 μs	200 μs	200 μs	200 μs	200 μs	200 μs
<b>Second phase</b>						
Initial current	29.2 A	18.8 A	15.1 A	13.2 A	12.1 A	11 A
Average current	14.7 A	13 A	12.5 A	11.3 A	10.7 A	9.9 A
Duration	4 ms	4 ms	4 ms	4 ms	4 ms	4 ms

Table A-2. Delivered Energy at Every Defibrillator Setting into a Range of Loads

Selected Energy	Load							Accuracy*
	25Ω	50Ω	75Ω	100Ω	125Ω	150Ω	175Ω	
1 J	1 J	1 J	1 J	1 J	1 J	1 J	1 J	±15%
2 J	1 J	2 J	2 J	2 J	2 J	2 J	2 J	±15%
3 J	2 J	3 J	3 J	3 J	3 J	3 J	3 J	±15%
4 J	3 J	4 J	4 J	5 J	5 J	5 J	4 J	±15%
5 J	3 J	5 J	6 J	6 J	6 J	6 J	6 J	±15%
6 J	4 J	6 J	7 J	7 J	7 J	7 J	7 J	±15%
7 J	5 J	7 J	8 J	8 J	8 J	8 J	8 J	±15%
8 J	5 J	8 J	9 J	9 J	10 J	9 J	9 J	±15%
9 J	6 J	9 J	10 J	11 J	11 J	11 J	10 J	±15%
10 J	7 J	10 J	12 J	12 J	12 J	12 J	12 J	±15%
15 J	10 J	16 J	17 J	18 J	18 J	18 J	17 J	±15%
20 J	14 J	21 J	23 J	24 J	24 J	24 J	23 J	±15%
30 J	21 J	32 J	35 J	36 J	37 J	36 J	35 J	±15%
50 J	35 J	54 J	59 J	61 J	62 J	61 J	59 J	±15%
70 J	49 J	76 J	83 J	85 J	87 J	86 J	83 J	±15%
85 J	60 J	92 J	101 J	104 J	106 J	104 J	101 J	±15%
100 J	71 J	109 J	119 J	122 J	125 J	123 J	119 J	±15%
120 J	85 J	131 J	143 J	147 J	150 J	147 J	143 J	±15%
150 J	107 J	164 J	180 J	183 J	188 J	184 J	179 J	±15%
200 J	142 J	230 J	249 J	253 J	269 J	261 J	260 J	±15%

\* For all energy levels, accuracy is equal to either ±15% or 3 joules, whichever is greater.

The X Series Rectilinear Biphasic waveform employs the same first and second phase timing, similar first and second phase currents/voltages, and essentially the same mechanisms for controlling defibrillation waveshape as the ZOLL R Series<sup>®</sup> defibrillator. The R Series and X Series defibrillation waveforms are considered substantially equivalent.

Figures A-1 through A-20 show the Rectilinear Biphasic waveforms that are produced when the X Series defibrillator is discharged into loads of 25, 50, 75, 100, 125, 150, and 175 ohms at each energy setting.

The vertical axis shows the current in amperes (A); the horizontal axis shows the duration of time in milliseconds (ms).

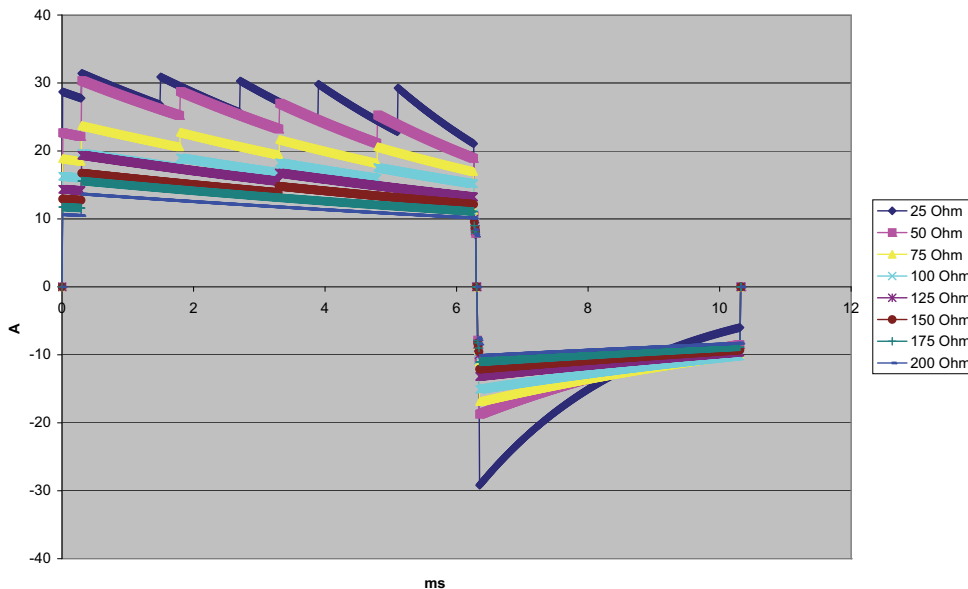


Figure A-1. Rectilinear Biphasic Waveform at 200 Joules

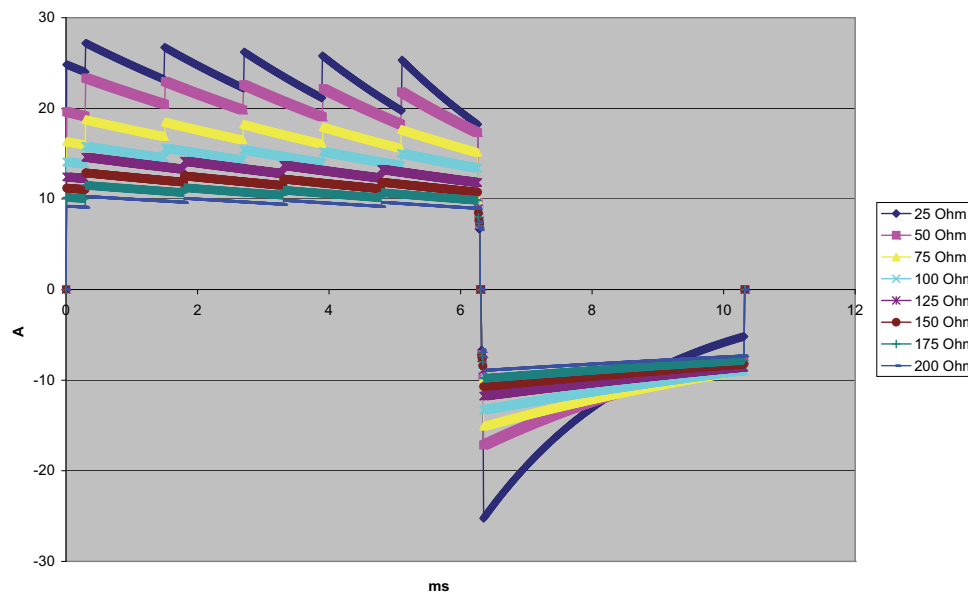


Figure A-2. Rectilinear Biphasic Waveform at 150 Joules

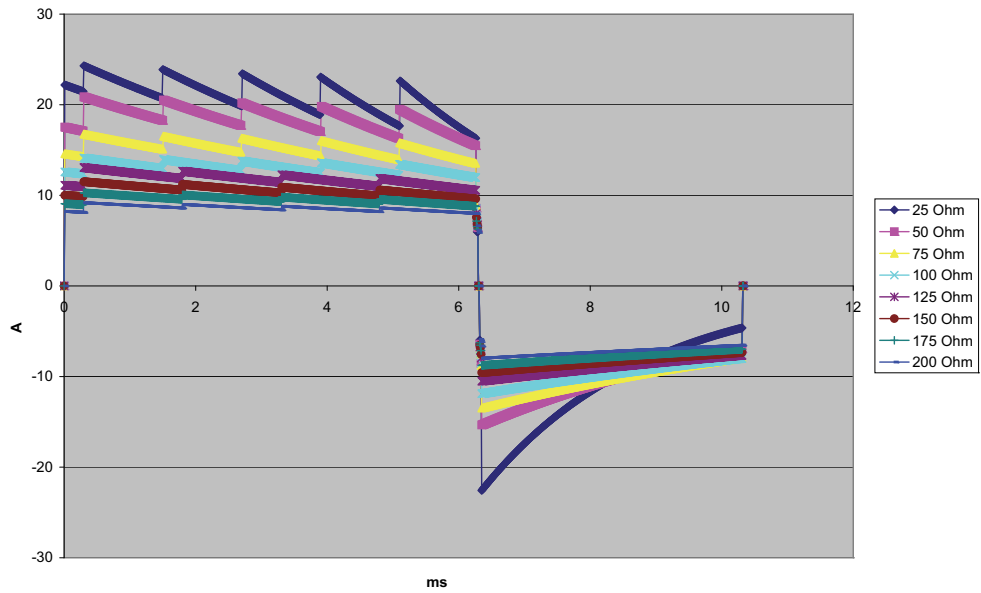


Figure A-3. Rectilinear Biphasic Waveform at 120 Joules

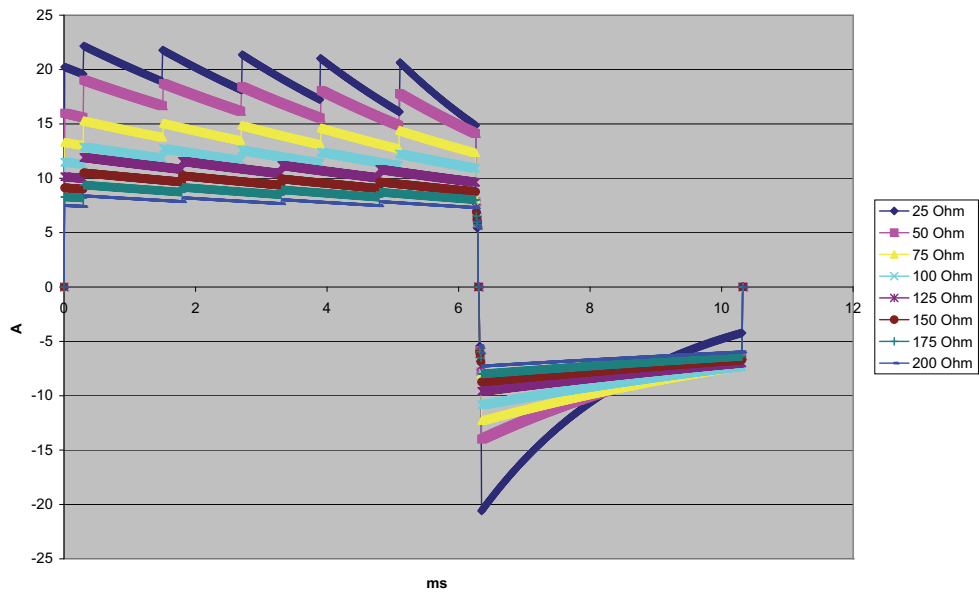


Figure A-4. Rectilinear Biphasic Waveform at 100 Joules

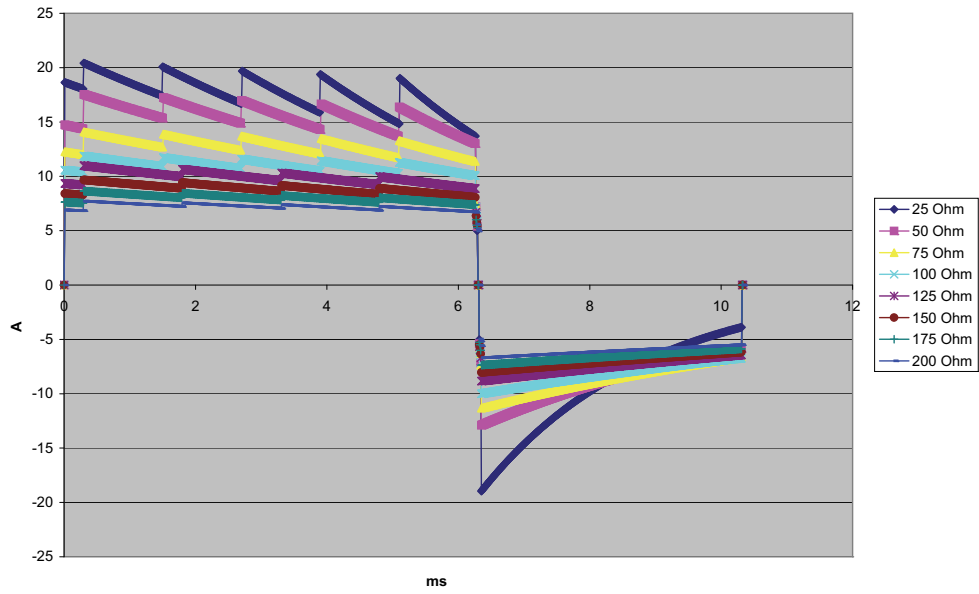


Figure A-5. Rectilinear Biphasic Waveform at 85 Joules

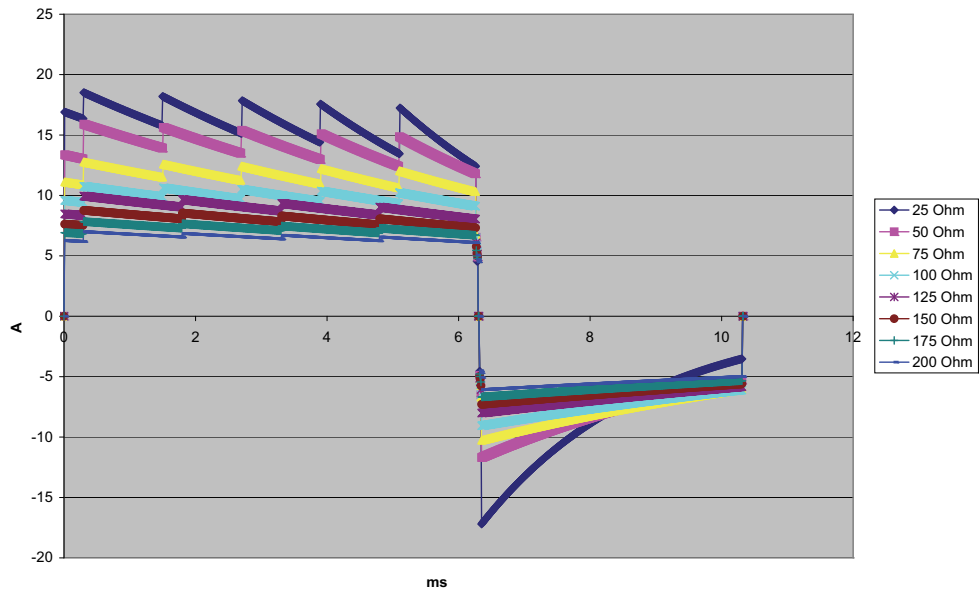


Figure A-6. Rectilinear Biphasic Waveform at 70 Joules



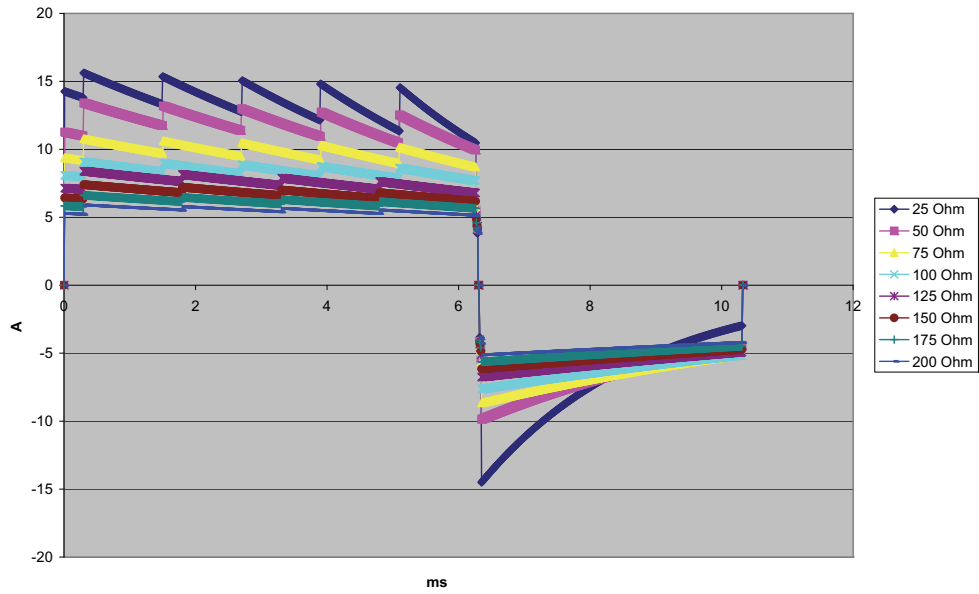


Figure A-7. Rectilinear Biphasic Waveform at 50 Joules

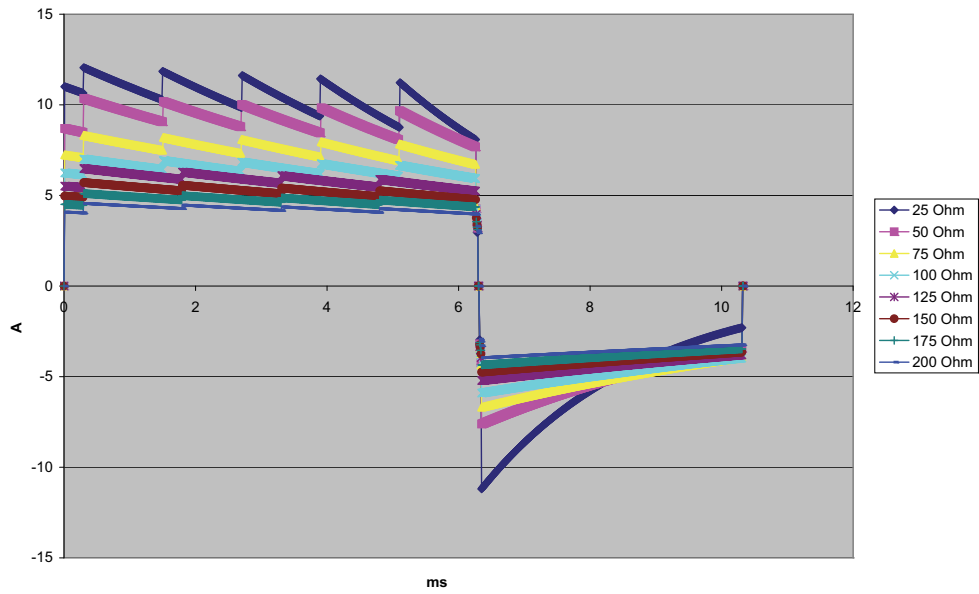


Figure A-8. Rectilinear Biphasic Waveform at 30 Joules

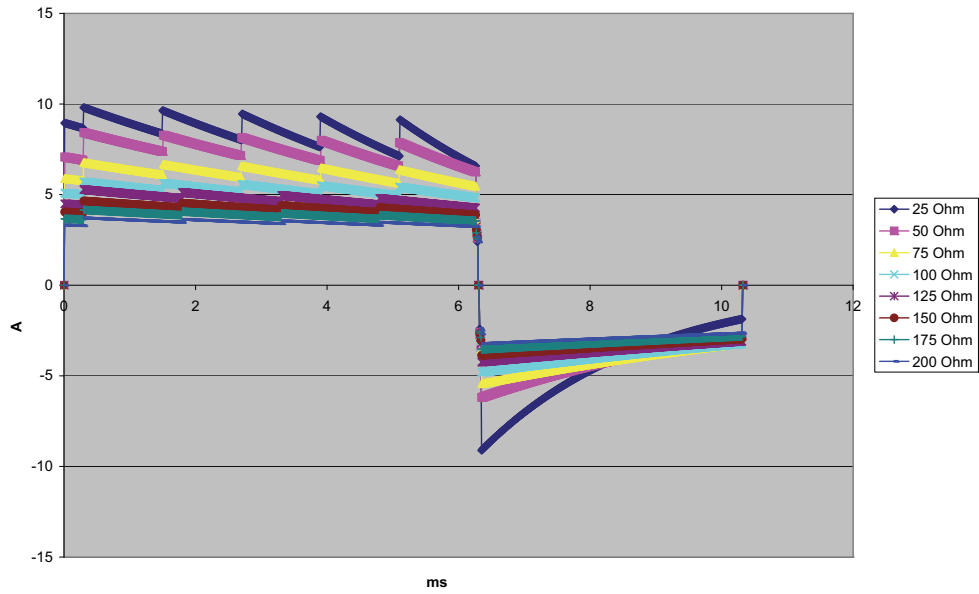


Figure A-9. Rectilinear Biphasic Waveform at 20 Joules

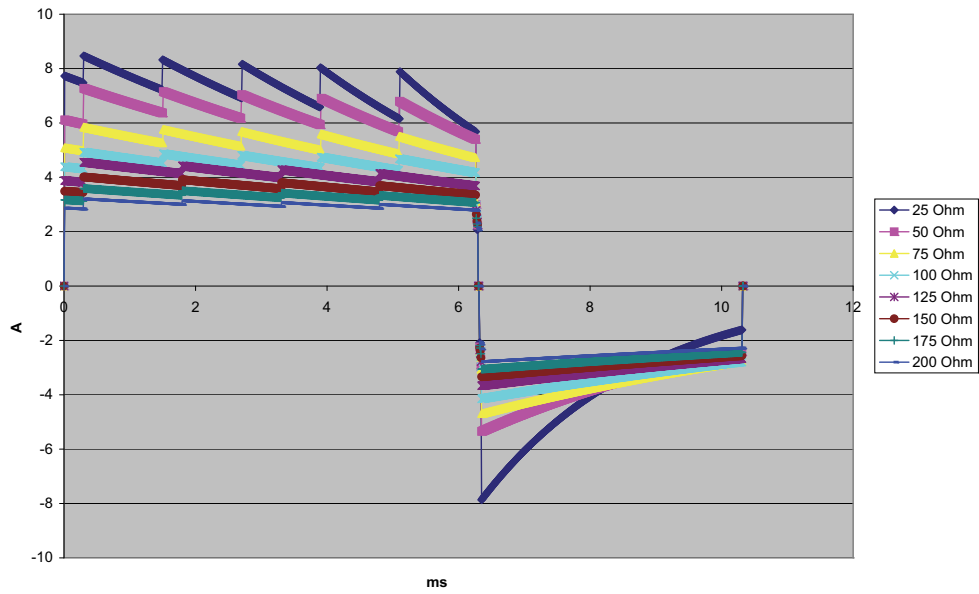


Figure A-10. Rectilinear Biphasic Waveform at 15 Joules

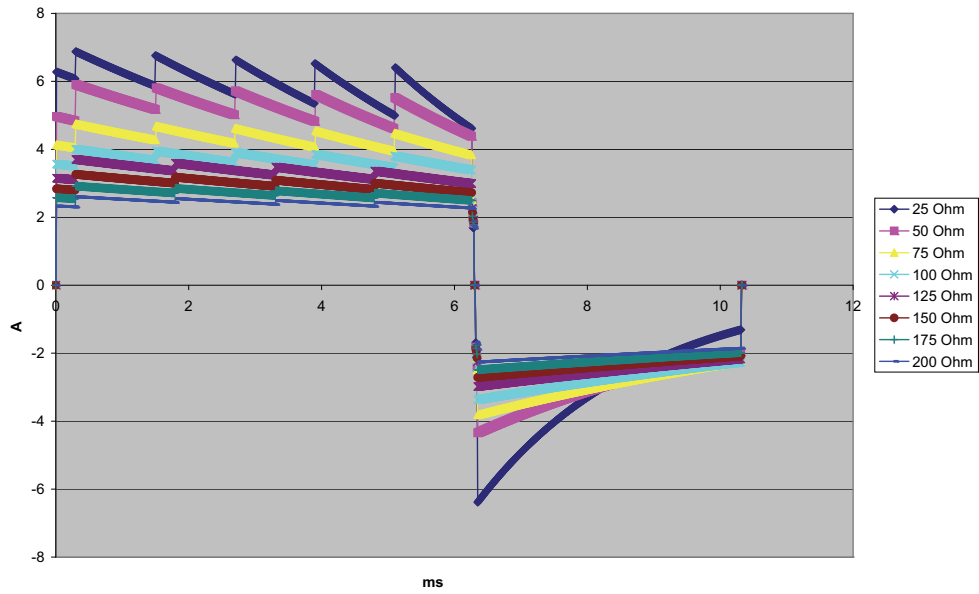


Figure A-11. Rectilinear Biphasic Waveform at 10 Joules

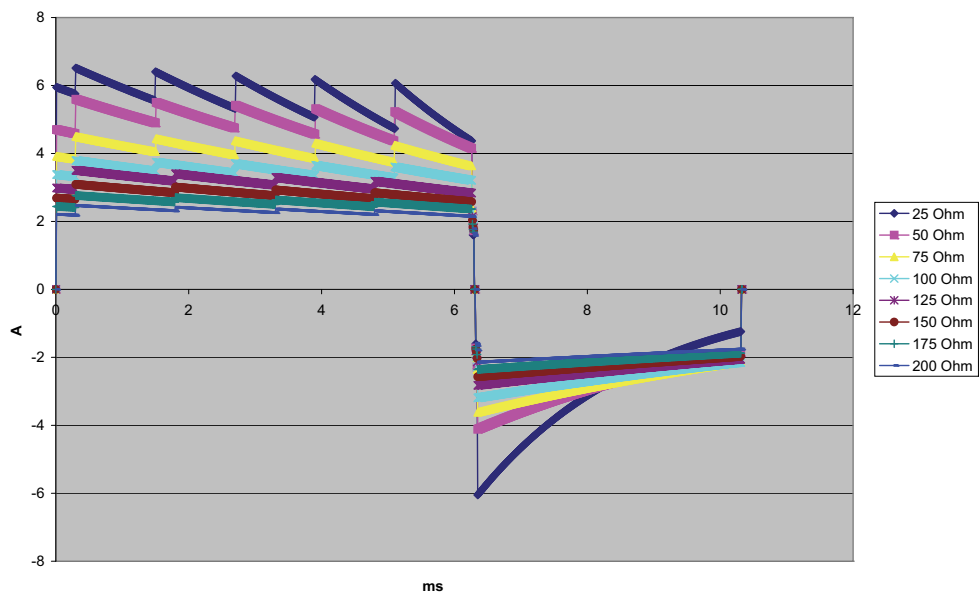


Figure A-12. Rectilinear Biphasic Waveform at 9 Joules

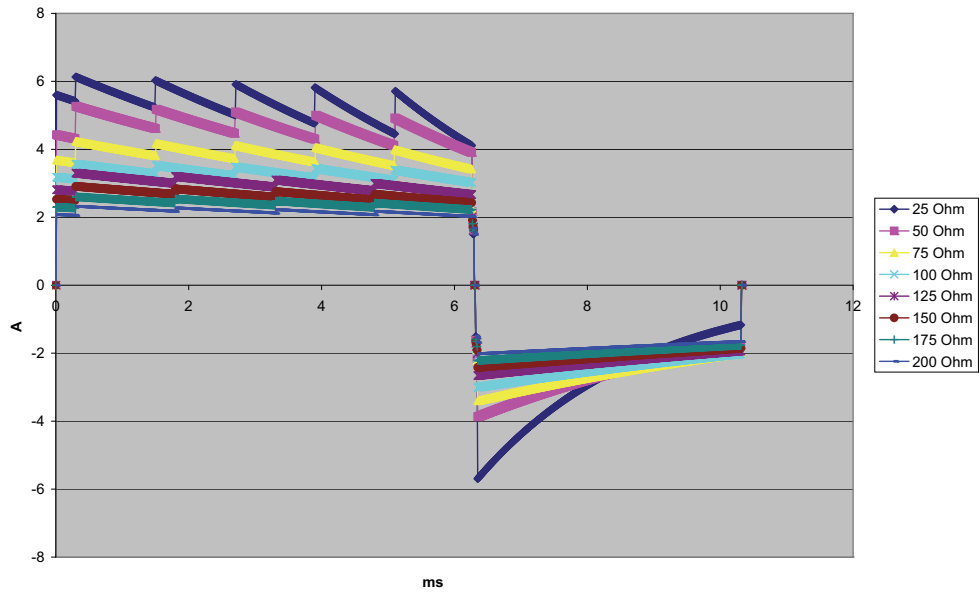


Figure A-13. Rectilinear Biphasic Waveform at 8 Joules

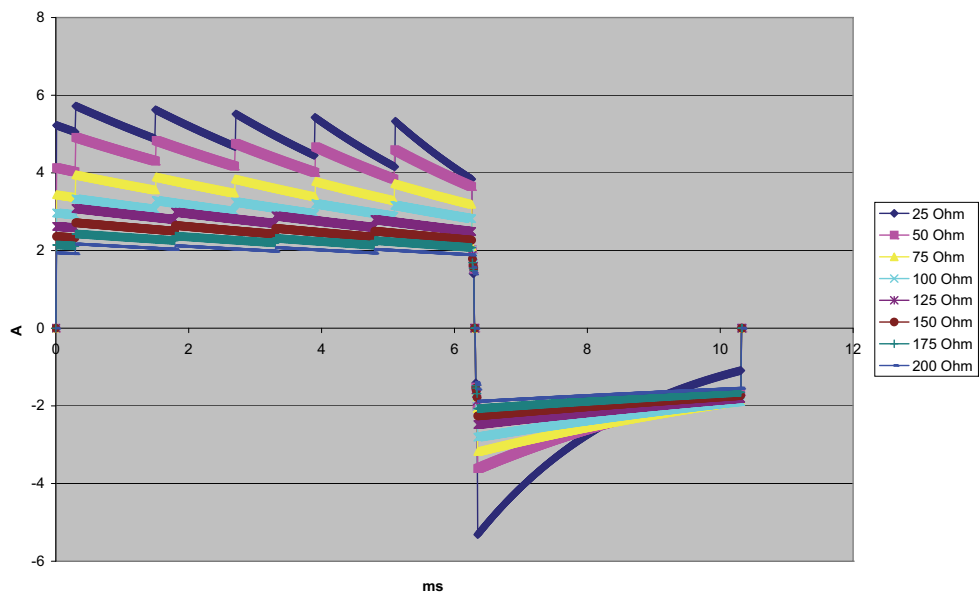


Figure A-14. Rectilinear Biphasic Waveform at 7 Joules

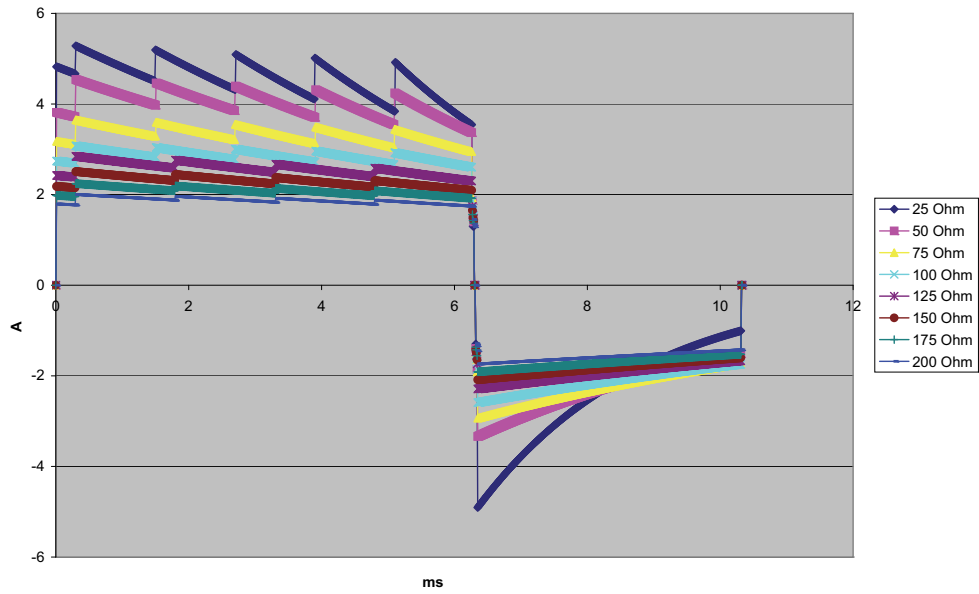


Figure A-15. Rectilinear Biphasic Waveform at 6 Joules

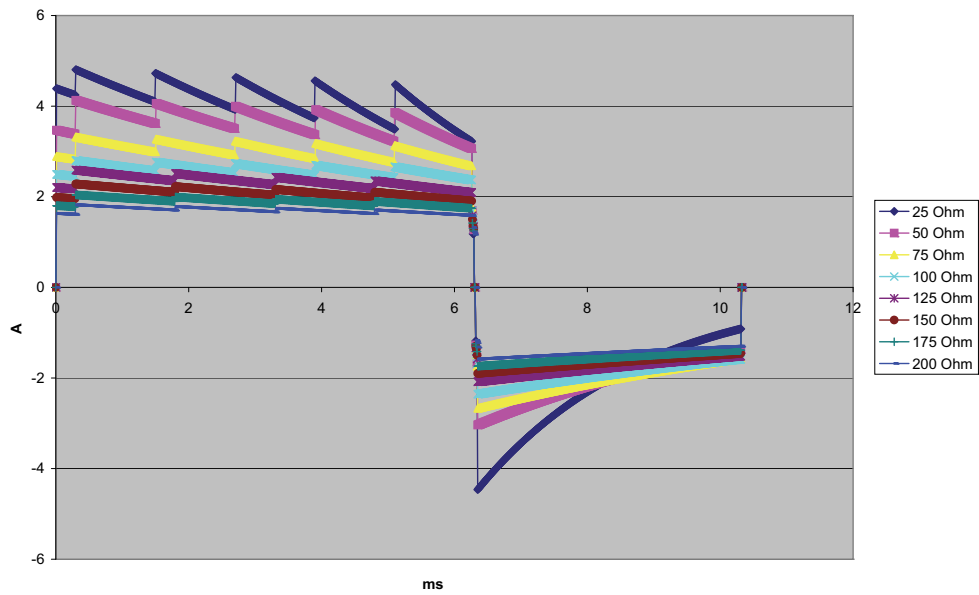


Figure A-16. Rectilinear Biphasic Waveform at 5 Joules

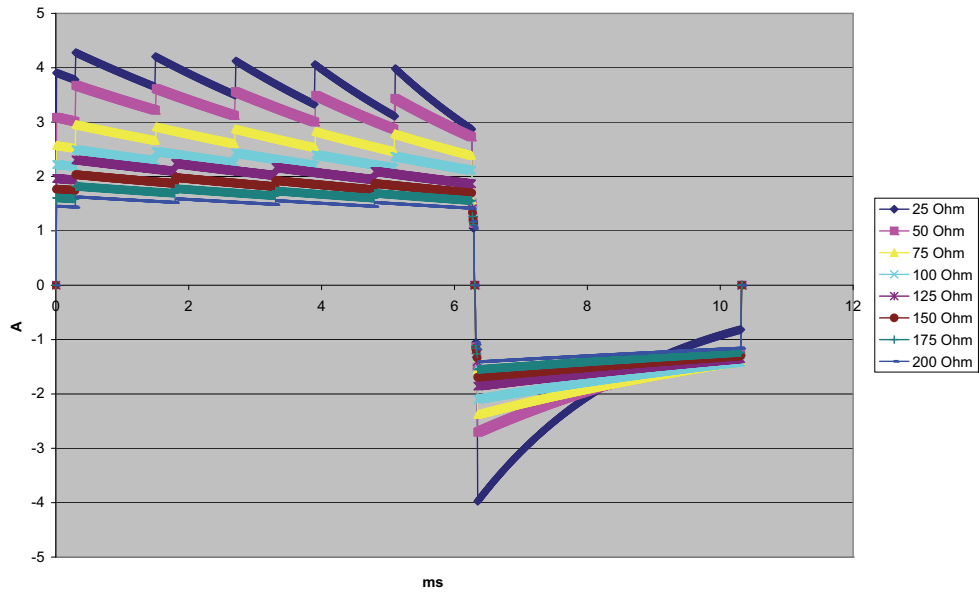


Figure A-17. Rectilinear Biphasic Waveform at 4 Joules

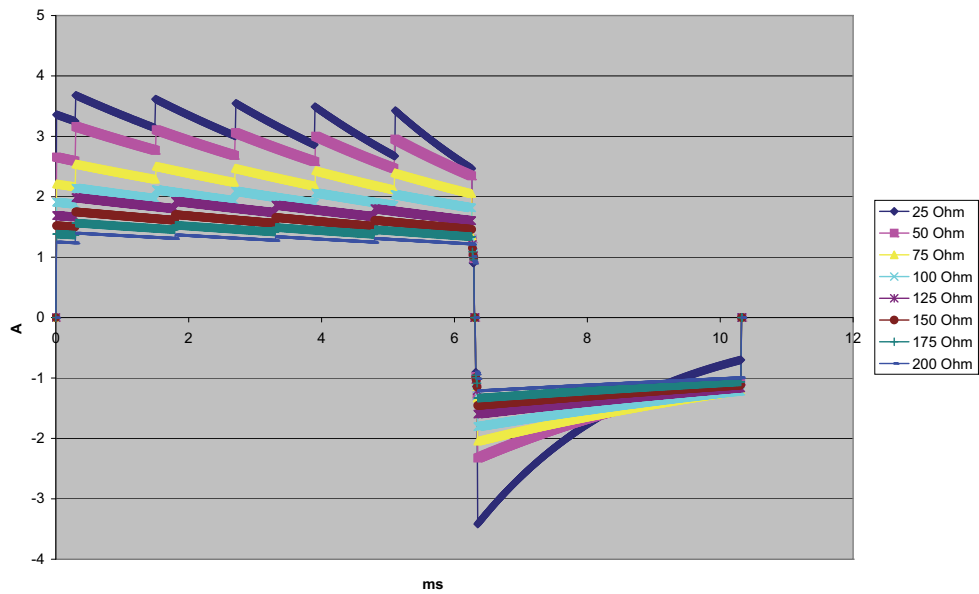


Figure A-18. Rectilinear Biphasic Waveform at 3 Joules

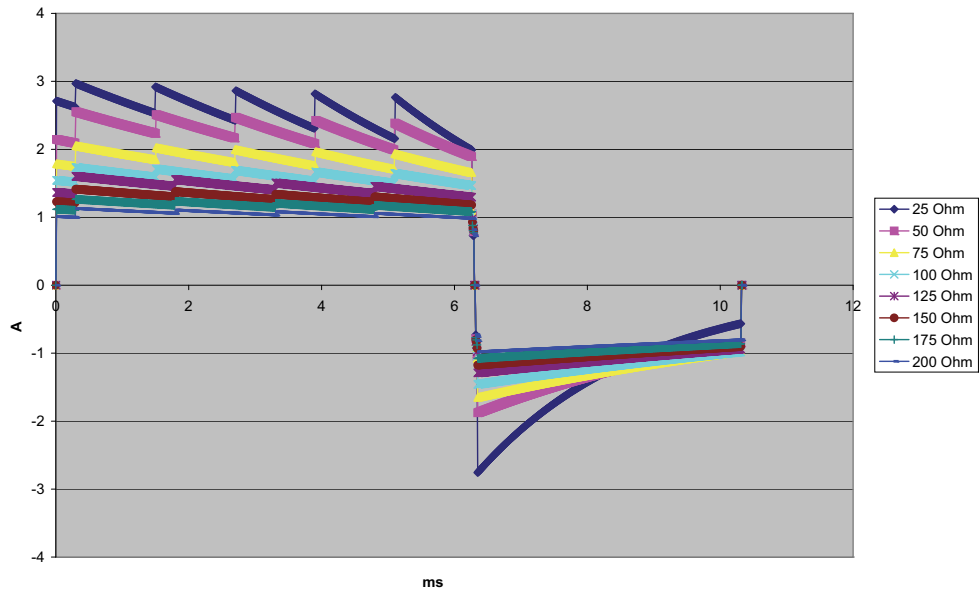


Figure A-19. Rectilinear Biphasic Waveform at 2 Joules

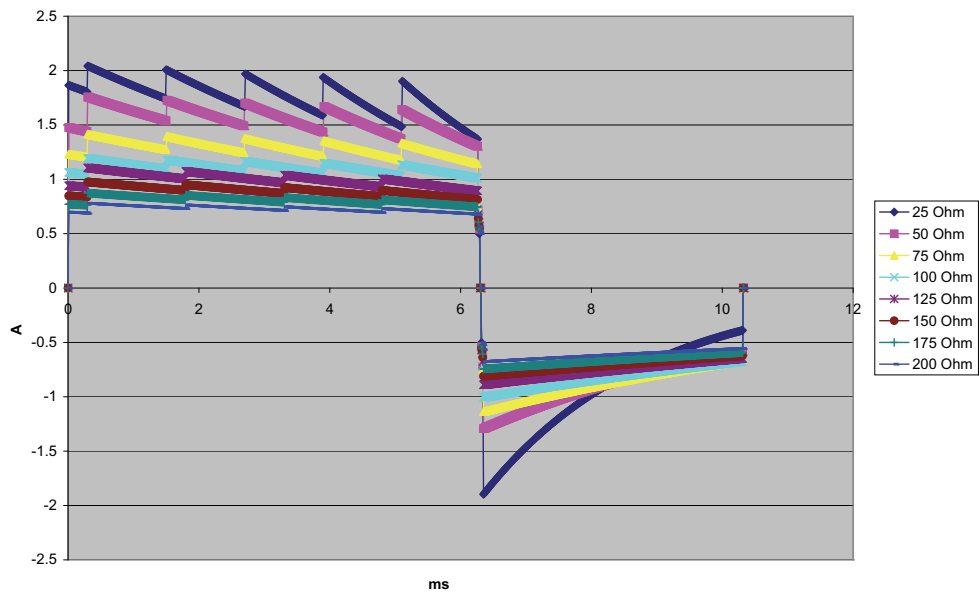


Figure A-20. Rectilinear Biphasic Waveform at 1 Joule

## Monitor/Display

**Input:** 3-lead, 5-lead, or 12-lead patient cable, paddles, Multifunction or OneStep electrodes.

**Type:** Color LCD, 640 x 480 pixels, 800 MCD

**Sweep Speed:** 25 mm / sec or 50 mm / sec (User Selectable)

**Lead Selections:** Paddles (Pads), I, II, III, AVR, AVL, AVF, V1-6.

**Frequency Response:**

Pads/Paddles:

0.67 to 20Hz Limited response

3/5/12 Lead Continuous Monitoring (user selectable):

0.67 to 20Hz Limited response

0.67 to 40Hz Monitor response

Acquired 12-lead snapshots (supervisor selectable):

0.525 to 40Hz Filtered Diagnostic response

0.525 to 150Hz Diagnostic response

Per methods a, b, c of EC11 3.2.7.2

(Automatically sets chart recorder response)

**Common Mode Rejection:**

Complies with AAMI EC13-2002 section 4.2.9.10.

**Tall T-Wave Rejection:**

Meets AAMI EC13-2002, section 4.1.2.1c for 0.9 mV

T-wave (0.8 mV with diagnostic response) and 1mV QRS.

**Diagnostic Signals Applied to Patient Connections:**

Leads off / active noise suppression sensing circuit is < 0.1 microamps DC. The impedance /respiration detector signal frequency is  $72 \pm 7$  kHz at 77 microamps RMS pseudo-sinewave into 100 ohms.

**Heart Rate Range:** 30 to 300 BPM.

**Heart Rate Accuracy:** +/- 3% or +/- 3BPM, whichever is greater.

**Displayed Heart Rate:** Average of last 5 beat-to-beat intervals.

**Heart Rate Alarms:** User-selectable.

**Size:** 0.125, 0.25, 0.5, 1, 2, 4 cm/mv and auto-ranging.

**Heart Rate Meter Response Time:**

Responds to a 40 BPM step increase in heart rate within 4.5 seconds per AAMI EC-13-2002, section 4.1.2.1.f. Responds to a 40 BPM step decrease within 3.9 seconds per AAMI EC-13-2002, section 4.1.2.1.f. Response times include a 1.0-second display update interval.



**Heart Rate Response to Irregular Rhythm:** (AAMI EC13-2002, section 4.1.2.1.e.)

**Ventricular Bigeminy:** 80 BPM (expected)

**Slow Alternating Ventricular Bigeminy:** 60 BPM (expected)

**Rapid Alternating Ventricular Bigeminy:** 120 BPM (expected)

**Bidirectional Systole:** 45 BPM (expected)

**Tachycardia Response Time:**

Response time to tachycardia alarm is on average 3.4 seconds per AAMI EC-13-2002, section 4.1.2.1.g, and IEC 60601-2-27:2011, subclause 201.7.9.2.9.101 b) 6). Response times include a 1.0 second display update interval.

**Pacemaker Pulse Rejection:**

(In accordance with AAMI EC13:2002, section 4.1.4 and IEC 60601-2-27:2011, subclause 201.12.1.101.13)

- Pulses without overshoot: Rejects all pulses with amplitude of +2 mV to +700 mV and duration of 0.1 ms to 2 ms, with no tail.
- Pulses with overshoot: Rejects all pulses with amplitude of +2 mV to +700 mV and duration of 0.1 ms to 2 ms, with overshoot up to 100 ms.
- A-V sequential pulses: A-V sequential pacemaker pulses may not be rejected.
- Fast ECG signals: Approximately 50% of ECG input pulses with a slew rate of 3 V/s RTI may trigger the pacemaker pulse detector.

**Electrosurgery Protection:** The X Series is suitable for use in the presence of electrosurgery as specified in IEC 60601-2-27. Burn hazard protection via a 1K current limiting resistor contained in each ECG leadwire.

## Impedance Pneumography

**Displayed Data:** Numeric breath rate, Impedance waveform

**Breath rate range:** Adult, Ped: 2 to 150 breaths / minute

Neonates: 3 to 150 breaths / minute

**Breath rate accuracy:** 2% or +/- 2 breaths / minute, whichever is greater

**Displayed Breath Rate:** Average of last 10 breath-to-breath rates.

**Leads:** Lead I (RA – LA), Lead II (RA – LL)

**Sweep Speed:** 3.13, 6.25, 12.5 mm/sec

**Alarm settings:** High, low and no breath rate alarm

## Alarms

### **Heart Rate Alarms:**

**Audible:** 5 pulse, 900 Hz tone, with a PW of 125 msec, a PRI of 250 msec, and a repetition interval of 15 seconds.

**Visual:** Heart Rate Alarm causes the heart rate to be displayed in red, with a white background. The red device status LED will flash a rate of 1.7 Hz.

### **Lead Fault Alarm:**

**Audible:** 3 pulse, 500 Hz, triplet tone with a PW of 200 msec, a PRI of 200 msec. The lead fault tone repeats at a repetition interval of 30 seconds.

**Visual:** Lead Fault condition causes a LEAD FAULT message to be displayed on the trace along with a dashed line the width of the trace.

### **Physiological Alarms (NIBP, SpO<sub>2</sub>, Resp, CO<sub>2</sub>, IP & Temp):**

**Audible:** Same as Heart Rate Alarm

**Visual:** Physiological alarms cause the alarming parameter to be displayed in Red with a white background. The red device status LED will flash at a rate of 1.7 Hz.

**Audio Pause (Silence) Duration:** 90 seconds.

### **Invalid Operation Alert Tone:**

A short, low-pitched tone is audible when a selected control button is unavailable for use or an invalid entry is detected. Tone frequency is 160 Hz. Duration is 250 msec.

### **Maximum Alarm Delay (Includes Alarm Condition Delay and Signal Generation Delay):**

#### **Heart rate/pulse rate:**

- if source is ECG, 9 seconds
- if source is SpO<sub>2</sub>, 10 seconds
- if source is IBP, 6 seconds
- if source is NIBP, no hold off

**SpO<sub>2</sub>, SpCO, and SpMet Saturation:** 10 seconds

**EtCO<sub>2</sub>:** 7 seconds

**FiCO<sub>2</sub>:** 5 seconds

**IBP (Systolic, Diastolic, Mean):** 3 seconds

**Temperature:** 2 seconds

---

## Recorder

**Type:** High-resolution thermal array.

**Annotation:** Time, date, ECG lead, ECG gain, heart rate, defibrillation and pacing parameters and treatment summary events.

**Paper Width:** 80 mm.

**Paper Speed:** 25 mm/sec, 50 mm/sec

**Delay:** 6 seconds.

**Frequency Response:** Automatically set to monitor's frequency response.

**Treatment Summary:**

10 switches to record key ACLS events (IV, INTUB, EPI, LIDO, ATROP, etc.).  
Automatically logs into memory the type of event, time and ECG sample.

**Full Disclosure Case Log:** A combination of 32 monitor snapshots; 500 non-ECG events; and 24 hours of continuous ECG (4 waveforms), Capnography, IBP (3 channels), and Pads Impedance. The actual information stored can be more or less depending on the use profile and the log configuration settings.

**Record Modes:** Manual and automatic (User-configurable).

## Battery

**Type:** Rechargeable Lithium-Ion, 11.1Vdc, 6.6 Ah, 73Wh

**Capacity:**

With a new, fully charged battery operating at room temperature:

- At least 6 hours of continuous monitoring of ECG, SpO<sub>2</sub>, CO<sub>2</sub>, three Invasive Pressure channels, and 2 channels of Temperature, with NIBP measurements every 15 minutes and 10 200 J shocks (display set to 30%).
- At least 100 discharges at maximum shock energy (200 joules).
- At least 3.5 hours pacing, with ECG, SPO<sub>2</sub>, CO<sub>2</sub>, three Invasive Pressures, temperature, NIBP every 15 minutes and pacing at 180 ppm, and 140 mA.
- At least 300 discharges at maximum shock energy (200 joules) with no parameters and 70% brightness.
- At least 10 discharges at maximum shock setting (200 joules) after a Low Battery indication.

**Note:** Proper battery care is required to maintain maximum available capacity.

**Battery Indicators:**

5 Battery capacity LED indicators, Fault indicator, Recalibration indicator

**Recharge Rate:** 100% in 4 hours, when initiated at Low Battery indication.

## General

### Weight:

10.6 lbs.without battery and paper

11.7 lbs.with battery and paper

### Dimensions:

Without Handle: 8.9" x 8.75" x 7.9"

With Handle: 8.9" x 10.4" x 7.9"

### Operating:

**Temperature:** 0 to 50° C

**Humidity:** 15 to 95% RH (non-condensing)

#### Vibration:

- EN ISO 9919 (per IEC 60068-2-64)
- RTCA/DO-160G (multiple helicopter frequencies)
- EN 1789 for ambulance

**Shock:** IEC 60068-2-27, 100g, 6ms half sine

**Bump:** IEC 60068-2-29

**Drop:** EN 1789, 30" functional drop

IEC 60601-1, Tested at 2 meters

**Altitude:** -170 M to 4572 M (-557 feet to 15,000 feet)

### Transport and Storage:

**Temperature:** -30 to 70°C

<p><b>Note:</b> The X Series device may not perform to specifications when stored at the upper or lower extreme limits of storage temperature and immediately put into use.</p>
---

**Humidity:** 15 to 95% RH (non-condensing)

**Atmospheric pressure:** 572 mbar to 1034 mbar

**Shock/vibration:** MIL STD 810G, Method 514.6, 4.4.2, Procedure II

**Safety Classification:** Class 1 and internal power per IEC/EN 60601-1

### Enclosure Protection:

**Solid Foreign Object:** IEC 60529, IP5X

**Water:** IEC 60529, IPX5

### AC Auxiliary Operating Power:

**REF** 8300-0004

Input: 100-240V  $\sphericalcap$  50-60 Hz, 2A

100-115V  $\sphericalcap$  400 Hz, 2A

Output: 14.5V  $\text{---}$  4.15A

80W (peak)

IP Rating: IP23

**DC Auxiliary Operating Power:**

REF 8300-000006

Input: 12-24V --- 11A

Output: 14.45V --- 4.15A  
80W peak

IP Rating: IP24

**Pacer****Type:** External transcutaneous pacing**Pacer Rate:** 30 to 180 BPM  $\pm$  1.5%.**Output Current:** 0 to 140 mA  $\pm$  5% or 5 mA (whichever is greater)**Modes:** Demand and Fixed**Status Indicators:**

ECG lead fault, pace marker on monitor and chart, start/stop indicator on display.

**Pulse Type:** Rectilinear, constant current**Pulse Width:** 40 ms  $\pm$  2 ms**CO<sub>2</sub>****Range:** 0 to 150 mmHg**Accuracy CO<sub>2</sub>:**

CO <sub>2</sub> Partial Pressure*	Accuracy **
0-38 mmHg	$\pm$ 2 mmHg
39-99 mmHg	$\pm$ (5% of reading + 0.08% for every 1 mmHg above 38 mmHg)
100-150 mmHg	$\pm$ (5% of reading + 0.08% for every 1 mmHg above 38 mmHg)

\* At sea level.

\*\* Accuracy applies for breath rates of up to 80 bpm. For breath rates above 80 bpm, accuracy is 4 mmHg or  $\pm$ 12% of reading whichever is greater, for EtCO<sub>2</sub> values exceeding 18 mmHg. This is tested according to and is compliant with ISO 21647. To achieve the specified accuracies for breath rates above 60 breaths/minute, the Microstream FilterLine H Set for Infant/Neonatal must be used. Above 40 C,  $\pm$  1mmHg or  $\pm$  2.5% (whichever is greater) has to be added to the tolerance of the accuracy specs.

**CO<sub>2</sub> Sampling Interval:** 50 msec**Drift of Measurement Accuracy:** Over any 24-hour period, the accuracy claims listed above are maintained.

The accuracy specification is maintained to within 4% for the following gas mixtures (all values are in Vol.%).

CO <sub>2</sub>	N <sub>2</sub>	O <sub>2</sub>	N <sub>2</sub> O	H <sub>2</sub> O	Anesthetic Agents
1.0 to 13	0 to 97.5	0 to 100	0 to 80	Dry to saturated	According to EN 21647

**Respiration Range:** 0 to 149 breaths per minute

**Respiration Rate Accuracy:**

0 to 70 bpm: ±1 bpm

71 to 120 bpm: ±2 bpm

121 to 149 bpm: ±3 bpm

**Flow rate:** 50 ml/min -7.5 + 15 ml/min, flow measured by volume.

**Total System Response Time:** 2.9 seconds typical, 3.9 seconds maximum.

## Pulse Oximeter

<b>Range:</b>	Oxygen Saturation (% SpO <sub>2</sub> )	0% - 100%
	Carboxyhemoglobin Saturation (% SpCO)	0% - 99%
	Methemoglobin Saturation (% SpMet)	0% - 99%
	Total Hemoglobin (g/dL SpHb)	0 – 25 g/dL
	Total Oxygen Content (% SpOC)	0 – 35 ml/dL
	Perfusion Index (% PI)	0.02% - 20%
	Pleth Variability Index (% PVI)	0% - 100%
	Pulse Rate (bpm)	25 - 240 beats per minute

**Accuracy: Oxygen Saturation (% SpO<sub>2</sub>) - During No Motion Conditions**

60 -80 ± 3%, Adults/Pediatrics/Infants

70 - 100 ± 2%, Adults/ Pediatrics/Infants; ± 3%, Neonates

**Oxygen Saturation (% SpO<sub>2</sub>) - During Motion Conditions**

70% - 100% ±3% Adults/ Pediatrics/Infants/Neonates

**Oxygen Saturation (% SpO<sub>2</sub>) - During Low Perfusion Conditions**

70 - 100 ± 2%, Adults/Pediatrics/Infants/Neonates

**Pulse Rate (bpm) - During No Motion Conditions**

25 - 240 ±3 bpm Adults/Pediatrics/Infants/Neonates

**Pulse Rate (bpm) - During Motion Conditions**

25 - 240 ±5 bpm Adults/Pediatrics/Infants/Neonates

**Pulse Rate (bpm) - During Low Perfusion Conditions**

25 - 240 ±3 bpm Adults/Pediatrics/Infants/Neonates

**Carboxyhemoglobin Saturation (% SpCO)**

1% - 40% ±3% Adults/Pediatrics/Infants

**Methemoglobin Saturation (% SpMet)**

1% - 15% ±1% Adults/Pediatrics/Infants/Neonates

**Total Hemoglobin (ml/dL SpHb)**

8 – 17 ±1 g/dL (arterial or venous) Adults/Pediatrics

**Resolution:**

SpO<sub>2</sub>: 1%

SpCO: 1%

SpMet: 0.1% for range up to 9.9%, 1% for range 10 - 99%

SpHb: 0.1 g/dL

SpOC: 0.1 ml/dL

PVI: 1%

PI: 0.1%

Pulse rate: 1 bpm (beats per minute)

**Alarm Limits:** On/Off displayed on monitor. User selectable.

SpO<sub>2</sub>: High 72 - 100% saturation, Low 70 - 98% saturation

SpCO: High 2 - 100% saturation, Low 0 - 99% saturation

SpMet: High 1 - 100% saturation, Low 0 - 99% saturation

SpHb: High 2 - 25 g/dL, Low 0 - 24.9 g/dL

SpOC: High 0.1 – 35 ml/dL, Low 0 – 34.9 ml/dL

PVI: High 2 – 100%, Low 0 – 98%

PI: High 0.2 – 20%, Low 0 – 19.8%

Pulse Rate: High 60 - 235 beats per minute, Low 20 - 100 beats per minute

### SpO<sub>2</sub> Wavelength for Sensors:

Masimo's LNOP and LNCS sensors use Red and Infrared light emitting diodes. The wavelengths for all of the sensors except LNOP tip clip (LNOP TC-I), LNCS/M-LNCS tip clip (LNCS/M-LNCS TC-I), LNOP transreflectance (LNOP TF-1), and LNCS/M- LNCS transreflectance (LNCS/M-LNCS TF-1), are identified as follows:

LED	Wavelength
Red	660 nm
Infrared	905 nm

The LNOP tip clip (LNOP TC-I) and LNCS/M-LNCS tip clip (LNCS/M-LNCS TC-I) sensors use different light emitting diodes. The wavelength information is as follows:

LED	Wavelength
Red	653 nm
Infrared	880 nm

The LNOP transreflectance (LNCS/M-LNCS TF-I) forehead sensors use different light emitting diodes. The wavelength information is as follows:

LED	Wavelength
Red	660 nm
Infrared	880 nm

For SpO<sub>2</sub> calculations with a rainbow sensor, the wavelength values shown in the above tables are the same. For rainbow parameter measurements, sensors use light emitting diodes in both the visible and infrared spectrum from the 500 nm to 1400 nm range.

### Energies (Radiant Power) of light for LNCS Sensors at 50 mA pulsed:

≤ 15 mW

### Energies (Radiant Power) of light for Rainbow Sensors at 100 mA pulsed:

≤ 25 mW

### Bio-Compatibility:

Patient contacting material meets requirements of ISO 10993-1, Biological Evaluation of Medical Device - Part I, for external devices, intact surfaces and short-term exposure

**Environmental:**

Operating Temperature: 0° to 50° C (32° to 122° F)

Storage Temperature: -40° to 70° C (-40° to 158° F)

**Electromagnetic Immunity (SpO<sub>2</sub> Option Only):**

AAMI DF-80; EN61000-4-3:2002 to 10 V/m

**Notes:**

- SpO<sub>2</sub>, SpCO and SpMet accuracy was determined by testing on healthy adult volunteers in the range of 60-100% SpO<sub>2</sub>, 0-40% SpCO, and 0-15% SpMet against a laboratory CO-Oximeter. SpO<sub>2</sub> and SpMet accuracy was determined on 16 neonatal NICU patients ranging in age from 7-135 days old and weighing between 0.5-4.25 kg. Seventy-nine (79) data samples were collected over a range of 70-100% SaO<sub>2</sub> and 0.5-2.5% MetHb with a resultant accuracy of 2.9% SpO<sub>2</sub> and 0.9% SpMet.
- The Masimo sensors have been validated for no motion accuracy in human blood studies on healthy adult male and female volunteers with light to dark skin pigmentation in induced hypoxia studies in the range of 70-100% SpO<sub>2</sub> against a laboratory CO-Oximeter and ECG monitor. This variation equals plus or minus one standard deviation. Plus or minus one standard deviation encompasses 68% of the population.
- The Masimo sensors have been validated for motion accuracy in human blood studies on healthy adult male and female volunteers with light to dark skin pigmentation in induced hypoxia studies in the range of 70-100% SpO<sub>2</sub> against a laboratory CO-oximeter and ECG monitor. This variation equals plus or minus one standard deviation which encompasses 68% of the population.
- The Masimo SET Technology has been validated for low perfusion accuracy in bench top testing against a Biotek Index 2 simulator and Masimo's simulator with signal strengths of greater than 0.02% and transmission of greater than 5% for saturations ranging from 70 to 100%. This variation equals plus or minus one standard deviation which encompasses 68% of the population.
- The Masimo sensors have been validated for pulse rate accuracy for the range of 25-240 bpm in bench top testing against a Biotek Index 2 simulator. This variation equals plus or minus one standard deviation which encompasses 68% of the population.
- SpHb accuracy has been validated on healthy adult male and female volunteers and on surgical patients with light to dark skin pigmentation in the range of 8-17 g/dl SpHb against a laboratory CO-oximeter. This variation equals plus or minus one standard deviation which encompasses 68% of the population. The SpHb accuracy has not been validated with motion or low perfusion.
- The following substances may interfere with pulse CO-Oximetry measurements:
  - Elevated levels of Methemoglobin (MetHb) may lead to inaccurate SpO<sub>2</sub> and SpCO measurements.
  - Elevated levels of Carboxyhemoglobin (COHb) may lead to inaccurate SpO<sub>2</sub> measurements.
  - Very low arterial Oxygen Saturation (SpO<sub>2</sub>) levels may cause inaccurate SpCO and SpMet measurements.
  - Severe anemia may cause erroneous SpO<sub>2</sub> readings.
  - Dyes, or any substance containing dyes, that change usual blood pigmentation may cause erroneous readings.
  - Elevated levels of total bilirubin may lead to inaccurate SpO<sub>2</sub>, SpMet, SpCO and SpHb readings.



---

# Non-Invasive Blood Pressure

**Technique:** Non-invasive oscillometric method

**Operating Modes:** Automatic and manual

**Automatic Intervals:** 1, 2, 3, 5, 10, 15, 30 and 60 minute intervals.

**Turbocuf:** Maximum measurements allowable in a 5 minute period

**Pressure Measurement Range:**

Systolic: 20 to 260 mmHg

Diastolic: 10 to 220 mmHg

Mean: 13 to 230 mmHg

**Static Pressure Accuracy:** +/- 3 mmHg

**Pulse Rate Range:**

Adult: 30 to 200 +/- 5 BPM

Pediatric: 30 to 200 +/- 5 BPM

Neonatal: 35 to 220 +/- 5 BPM

**Default Cuff Inflation Pressure:**

Adult: 160 mmHg

Pediatric: 120 mmHg

Neonatal: 90 mmHg

**Maximum Cuff Inflation Pressure:**

Adult: 270 mmHg

Pediatric: 170 mmHg

Neonatal: 130 mmHg

**Single Fault Backup Overpressure Limit:**

Adult: 308 mmHg

Pediatric: 205 mmHg

Neonatal: 154 mmHg

**Typical Determination time without Artifact:**

**Measurements on the deflation:** 30 to 45 seconds

**Measurements on the inflation (SureBP)\*:** 15 to 30 seconds

\* using dual lumen cuffs

**Maximum Determination Time - Measurement on the Inflation**

Adult: 150 seconds

Pediatric: 120 seconds

Neonatal: 80 seconds

**Blood Pressure Validation:**

Blood pressure measurements determined with this device are equivalent to those obtained by a trained observer using the cuff/stethoscope auscultation method for adults and pediatric patients and equivalent to an intra-arterial measurement for neonatal patients, within the limits prescribed by the American National Standards Institute (ANSI-AAMI SP10). To receive a copy of the report containing the AAMI SP10 results, contact the ZOLL Technical Service Department.

**NIBP Accuracy:**

NIBP accuracy has been verified utilizing clinical test methods which have been determined to meet the requirements of EN ISO 81060-2:2012.

## Invasive Pressures

**Number of Channels:** 3

**Pressure range:** -30 to 300 mmHg

**Pressure Accuracy:** +/- 2 mmHg or 2% of reading, whichever is greater, plus error.

**Pulse Rate Range:** 25 to 250 BPM

**Pulse Rate Accuracy:** +/- 3 BPM, or +/- 3% of value whichever is greater

**Pulse Rate Display:** Average of last 4 beat-to-beat intervals.

**Zero Adjust:** + / - 200 mmHg

:

Sensitivity: 5uV/V/mmHg

Offset: +/- 125 mmHg including offset

Excitation Impedance Range: 150 to 10,000 ohms

Excitation Voltage: 4.75 +/- 0.25 VDC

Connector: 6-pin circular MS3100 series

Connect to:	A	B	C	D	E
Signal Type	Sig (-)	Exc (+)	Sig (+)	Exc (-)	shield

---

# Temperature

**Number of Channels:** 2

**Measurement Range:** 0° to 50° C

**Accuracy:**

± 0.1° C from 10° C to 50° C, plus probe error

± 0.2° C from 0° C to 10° C, plus probe error

**Resolution:** 0.1° C

**Scale:** Fahrenheit or Celsius.

**Temperature Display Signal:** 20Hz, no averaging.

**Probe:** YSI 400 and 700 series

**Mode of Operation:** Direct mode

**Display:** T1, T2, ΔT

**Minimum Measurement Time:** See the probe's Instructions for Use to obtain minimum measurement times for accurate readings. The X Series does not add any clinically significant time to obtain accurate readings.

---

## Clinical Trial Results for the Biphasic Waveform

The efficacy of the ZOLL Rectilinear Biphasic waveform has been clinically verified during a study of defibrillation of Ventricular Fibrillation (VF) and Ventricular Tachycardia (VT). A feasibility study was performed initially for defibrillation of VF/VT (n=20) on two separate groups of patients to ensure waveform safety and energy selection. Subsequently, a separate, multicenter, randomized clinical trial was performed to verify the waveform's efficacy. A description of this study is provided below. The study was performed using ZOLL defibrillation systems consisting of ZOLL defibrillators, the ZOLL Rectilinear Biphasic waveform, and ZOLL defibrillation electrodes.

### Randomized Multicenter Clinical Trial for Defibrillation of Ventricular Fibrillation (VF) and Ventricular Tachycardia (VT)

**Overview:** The defibrillation efficacy of the ZOLL Rectilinear Biphasic waveform was compared to a monophasic damped sine waveform in a prospective, randomized, multicenter study of patients undergoing ventricular defibrillation for VF/VT during electrophysiological studies, ICD implants, and test. A total of 194 patients were enrolled in the study. Ten patients who did not satisfy all protocol criteria were excluded from the analysis, leaving a study population of 184.

**Objectives:** The primary goal of this study was to compare the first shock efficacy of the 120 J rectilinear biphasic waveform with a 200 J monophasic waveform. The secondary goal was to compare all shock (three consecutive 120, 150, and 170 joules) efficacy of the rectilinear biphasic waveform with that of a monophasic waveform (three consecutive 200, 300, and 360 joules). A significance level of  $p=0.05$  or less was considered statistically significant using Fischer's Exact test. Also, differences between the two waveforms were considered statistically significant when the customary 95% or AHA-recommended 90%<sup>1</sup> confidence interval between the two waveforms was greater than 0%.

**Results:** The study population of 184 patients had a mean age of  $63\pm 14$  years. Of these, 143 patients were male. There were no adverse events or injuries related to the study.

The first shock, first induction efficacy of biphasic shocks at 120 J was 99% versus 93% for monophasic shocks at 200 J ( $p=0.0517$ , 95% confidence interval of the difference of  $-2.7\%$  to  $16.5\%$  and 90% confidence interval of the difference of  $-1.01\%$  to  $15.3\%$ ).

Successful defibrillation with rectilinear biphasic shocks was achieved with 58% less delivered current than with monophasic shocks ( $14\pm 1$  amperes versus  $33\pm 7$  amperes,  $p=0.0001$ ).

The difference in efficacy between the rectilinear biphasic and the monophasic shocks was greater in patients with high transthoracic impedance (greater than 90 ohms). The first shock, first induction efficacy of biphasic shocks was 100% versus 63% for monophasic shocks for patients with high impedance ( $p=0.02$ , 95% confidence interval of the difference of  $-0.0217\%$  to  $0.759\%$  and 90% confidence interval of the difference of  $0.037\%$  to  $0.706\%$ ).

---

1. Kerber RE, et al., "Automated External Defibrillators for Public Access Defibrillation: Recommendations for Specifying and Reporting Arrhythmia Analysis Algorithm Performance, Incorporating New Waveforms, and Enhancing Safety," *Circ J Am Heart Assoc.* 1997;95:1677-1682.

"... the task force suggests that to demonstrate superiority of an alternative waveform over standard waveforms, the upper boundary of the 90% confidence interval of the difference between standard and alternative waveforms must be  $<0\%$  (ie, alternative is greater than standard)."

A single patient required a second biphasic shock at 150 joules to achieve 100% efficacy versus six patients for whom monophasic shocks of up to 360 joules were required for 100% total defibrillation efficacy.

**Conclusion:** The data demonstrate the equivalent efficacy of low energy rectilinear biphasic shocks compared to standard high energy monophasic shocks for transthoracic defibrillation for all patients at the 95% confidence level. The data also demonstrate the superior efficacy of low energy rectilinear biphasic shocks compared to standard high energy monophasic shocks in patients with high transthoracic impedance at the 90% confidence level. There were no unsafe outcomes or adverse events due to the use of rectilinear biphasic waveform.

## Randomized Multi-Center Clinical trial for Cardioversion of Atrial Fibrillation (AF)

**Overview:** The defibrillation efficacy of ZOLL's Rectilinear Biphasic Waveform was compared to a monophasic damped sine waveform in a prospective randomized multi-center study of patients undergoing cardioversion of their atrial fibrillation. A total of 173 patients entered the study. Seven (7) patients who did not satisfy all protocol criteria were excluded from the analysis. ZOLL disposable gel electrodes with surface areas of 78 cm<sup>2</sup> (anterior) and 113 cm<sup>2</sup> (posterior) were used exclusively for the study.

**Objective:** The primary goal of the study was to compare the total efficacy of four consecutive rectilinear biphasic shocks (70J, 120J, 150J, 170J) with four consecutive monophasic shocks (100J, 200J, 300J, 360J). The significance of the multiple shocks efficacy was tested statistically via two procedures, the Mantel-Haenszel statistic and the log-rank test, significance level of  $p=0.05$  or less was considered statistically significant. The data are completely analogous to the comparison of two "survival" curves using a life-table approach where shock number plays the role of time.

The secondary goal was to compare the first shock success of rectilinear biphasic and monophasic waveforms. A significance level of  $p=0.05$  or less was considered statistically significant using Fisher Exact tests. Also, differences between the two waveforms were considered statistically significant when the 95% confidence interval between the two waveforms was greater than 0%.

**Results:** The study population of 165 patients had a mean age of  $66 \pm 12$  years with 116 male patients.

The total efficacy of consecutive rectilinear biphasic shocks was significantly greater than that of monophasic shocks. The following table displays the Kaplan-Meier (product-limit) “survival” curves for each of the two waveforms. As all patients begin in the failure mode, the estimated life-table probabilities refer to the chance of still being in failure after the  $k^{\text{th}}$  shock ( $k=1,2,3,4$ ):

**Table A-3. Kaplan-Meier Estimate for the Probability of Shock Failure**

Shock #	Biphasic	Monophasic
0	1.000	1.000
1	0.318	0.792
2	0.147	0.558
3	0.091	0.324
4	0.057	0.208

As can be seen from the table, the Biphasic experience is superior over the entire course of shocks delivered. The one degree of freedom chi-square statistic for the Mantel-Haenszel test is 30.39 ( $p < 0.0001$ ). Similarly, the log-rank test, also a one degree of freedom chi-square statistic, is 30.38 ( $p < 0.0001$ ). The residual number of patients not successfully treated after four shocks is 5.7% for biphasic compared to 20.8% for monophasic.

There was a significant difference between the first shock efficacy of biphasic shocks at 70J of 68% and that of monophasic shocks at 100J of 21% ( $p = 0.0001$ , 95% confidence interval of the difference of 34.1% to 60.7%).

Successful cardioversion with rectilinear biphasic shocks was achieved with 48% less delivered current than with monophasic shocks ( $11 \pm 1$  vs.  $21 \pm 4$  A,  $p < 0.0001$ ).

One half of the patients who failed cardioversion after four consecutive escalating monophasic shocks were subsequently successfully cardioverted using a biphasic shock at 170J. No patient was successfully cardioverted using a 360J monophasic shock after the patient had failed cardioversion with biphasic shocks.

**Conclusion:** The data demonstrate the superior efficacy of low energy rectilinear biphasic shocks compared to high energy monophasic shocks for transthoracic cardioversion of atrial fibrillation. There were no unsafe outcomes or adverse events due to the use of Rectilinear Biphasic Waveform.

---

## Pre-Clinical Study

To support pediatric usage for the ZOLL Rectilinear Bi-Phasic Waveform, ZOLL submitted pre-clinical data to the FDA as part of a 510(k) submission for its AED Plus device (cleared by the FDA under K033474). The protocol for this pre-clinical study, along with a summary of the results, have been submitted to FDA under AED Plus PMA application (P160015). A summary of this study is presented below.

To demonstrate the safety and efficacy of our Rectilinear Bi-Phasic Waveform when used to treat pediatric VF patients, ZOLL conducted a study using a porcine model of pediatric patients less than 8 years of age. This study included 18 piglets in three (3) size groups (two (2) animals weighing 4 kg, eight (8) animals weighing 8 kg, and eight (8) animals weighing 16 kg) and compared the defibrillation dose/response curves observed using proposed biphasic waveform with those observed using a standard monophasic damped sine wave (DSW) defibrillator to treat short duration (~ 30 seconds) ventricular fibrillation. The study demonstrated that the biphasic waveform defibrillates pediatric pigs with equal efficacy but lower energy (on a Joules/kg basis) than traditional monophasic damped sine wave defibrillators. To confirm the safety of the proposed biphasic waveform in pediatric patients, we studied and compared measures of cardiac function before and after both DSW and Rectilinear Bi-Phasic Waveform defibrillation shocks over a range of relevant energies. The study demonstrated that the biphasic defibrillation produced equivalent or milder disturbances of cardiac function when compared to traditional DSW defibrillation at the same energies.

Another animal study compared the ZOLL rectilinear biphasic (RLB) waveform to a biphasic truncated exponential (BTE) waveform. The study, using an immature porcine model (n=21), was a prospective, randomized, controlled design to determine the dose response curves for the RLB and BTE defibrillation waveforms. A weight range from 4 to 24 Kg for an animal represented a pediatric patient. The weight ranging from 4 to 8 Kg represented a patient less than 1 year old (infant subgroup), and the weight range from 16 to 24 Kg represented a pediatric patient between the ages of 2 and 8 years (young children subgroup).

The ZOLL RLB waveform demonstrated a superior capability to defibrillate a porcine pediatric model with < 90% of the D50 energy required for a BTE waveform (D50 energy: RLB  $25.6 \pm 15.7$  J, BTE  $28.6 \pm 17.0$  J, P ? 0.0232; D90 energy: RLB  $32.6 \pm 19.1$  J, BTE  $37.8 \pm 23.2$  J, P ? 0.0228).

The ECG ST segment changes (mV) and LV pressure changes (dP/dt) following a defibrillation shock were compared between the RLB waveform to the BTE waveform. The RLB waveform had an average ST segment increase above baseline of  $0.138 \pm 0.136$  mV (N=401 shocks) compared to the BTE waveform's average increase of  $0.146 \pm 0.148$  mV (N=396 shocks). The RLB waveform had an average dP/dt at the 40 mmHg threshold (the point in time when an animal's blood pressure exceeded 40 mmHg spontaneously) of  $1987 \pm 411$  mmHg/s (N=496 shocks) compared to the BTE waveform's average dP/dt of  $2034 \pm 425$  mmHg/s (N=496 shocks).

## Published Clinical Data

Additional clinical data was included with PMA application P160015 to support out-of-hospital use of ZOLL's Rectilinear Bi-Phasic defibrillation waveform. The data reported by Hess et al in Resuscitation (82 (2011) 685–689) is considered sufficient to support ZOLL's defibrillation waveform in the out-of-hospital environment. The resulting clinical paper, "Performance of a rectilinear biphasic waveform in defibrillation of presenting and recurrent ventricular fibrillation: A prospective multicenter study," was included with PMA application P160015. A summary of the study is presented below:

**Objectives:** The study tested the hypothesis that shock success differs with initial and recurrent episodes of ventricular fibrillation (VF).

**Methods:** From September 2008 to March 2010 out-of-hospital cardiac arrest patients with VF as the initial rhythm at 9 study sites were defibrillated by paramedics using a rectilinear biphasic waveform. Shock success was defined as termination of VF within 5 s post-shock. The study used generalized estimating equation (GEE) analysis to assess the association between shock type (initial versus defibrillation) and shock success.

**Results:** Ninety-four patients presented in VF. Mean age was 65.4 years, 78.7% were male, and 80.9% were bystander-witnessed. VF recurred in 75 (79.8%). There were 338 shocks delivered for initial

(n = 90) or recurrent (n = 248) VF available for analysis. Initial shocks terminated VF in 79/90 (87.8%) and subsequent shocks in 209/248 (84.3%). GEE odds ratio (OR) for shock type was 1.37 (95% CI 0.68–2.74). After adjusting for potential confounders, the OR for shock type remained insignificant (1.33, 95% CI 0.60–2.53). The study observed no significant difference in ROSC (54.7% versus 52.6%, absolute difference 2.1%, p = 0.87) or neurologically intact survival to hospital discharge (21.9% versus 33.3%, absolute difference 11.4%, p = 0.31) between those with and without VF recurrence.

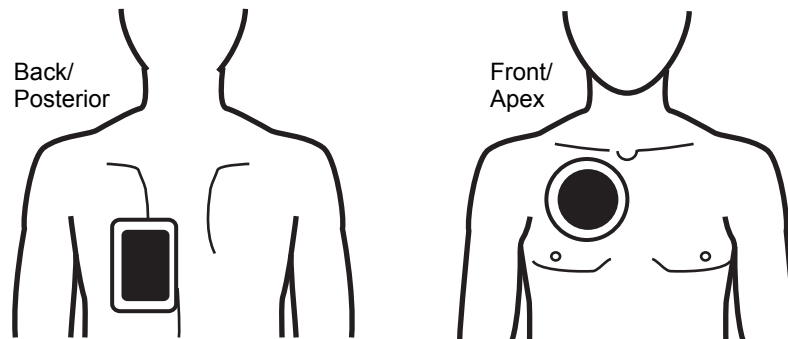
**Conclusions:** Presenting VF was terminated with one shock in 87.8% of cases. The study observed no significant difference in the frequency of shock success between initial versus recurrent VF. VF recurred in the majority of patients and did not adversely affect shock success, ROSC, or survival.



## Synchronized Cardioversion of Atrial Fibrillation

Cardioversion of atrial fibrillation (AF) and overall clinical effectiveness is enhanced by proper pad placement. Clinical studies (refer to above) of the M Series Biphasic Defibrillator Waveform demonstrated that high conversion rates are achieved when defibrillation pads are placed as shown in the following diagram.

Recommended Anterior/Posterior Placement



Place the front (apex) pad on the third intercostal space, mid clavicular line on the right anterior chest. The back/posterior pad should be placed in the standard posterior position on the patient's left as shown.

# Electromagnetic Compatibility Guidance and Manufacturer’s Declaration

## In-Flight Use (RTCA/DO-160):

The X Series unit complies with RTCA/DO-160, Environmental Conditions and Test Procedures for Airborne Equipment, using the methods in Section 21, Category M for Radiated and Conducted Radio Frequency Energy.

<b>Guidance and manufacturer’s declaration – electromagnetic emissions</b>		
The X Series unit is intended for use in the electromagnetic environment specified below. The customer or the user of the X Series unit should assure that it is used in such an environment.		
<b>Emissions test</b>	<b>Compliance</b>	<b>Electromagnetic environment – guidance</b>
<b>RF emissions CISPR 11</b>	Group 1	The X Series unit uses RF energy only for its internal function. Therefore, its RF emissions are very low and are not likely to cause any interference in nearby electronic equipment.
<b>RF emissions CISPR 11</b>	Class B	The X Series unit is suitable for use in all establishments, including domestic establishments and those directly connected to the public low-voltage power supply network that supplies buildings used for domestic purposes.
<b>Harmonic emission IEC 61000-3-2</b>	Class A	
<b>Voltage fluctuations/ flicker emissions IEC 61000-3-3</b>	Complies	
Medical Electrical Equipment needs special precautions regarding EMC and needs to be installed and put into service according to EMC information provided in this document.		

## Electromagnetic Immunity (IEC 60601-1-2)


The X Series defibrillator's essential performance is defibrillation (Defib), pacing, ECG, SpO<sub>2</sub>, CO<sub>2</sub> (respiration), IBP, NIBP, and temperature (TEMP), as specified in A-2 through A-25. The X Series defibrillator meets basic safety and essential performance when it is operated in the electromagnetic environment specified in the following tables.

<b>Guidance and manufacturer's declaration – electromagnetic immunity</b>			
The X Series unit is intended for use in the electromagnetic environment specified below. The customer or the user of the X Series should assure that it is used in such an environment.			
<b>Immunity test</b>	<b>IEC 60601 test level</b>	<b>Compliance level</b>	<b>Electromagnetic environment – guidance</b>
Electrostatic discharge (ESD) IEC 61000-4-2	± 8 kV contact ± 15 kV air	± 8 kV contact ± 15 kV air	The relative humidity should be at least 5%.
Electrical fast transient / burst IEC 61000-4-4	± 2 kV for power supply lines ± 1 kV for input/output lines	± 2 kV for power supply lines ± 1 kV for input/output lines	Mains power quality should be that of a typical commercial or hospital environment.
Surge IEC 61000-4-5	± 1 kV line(s) to line(s) ± 2 kV line(s) to earth	± 1 kV differential mode ± 2 kV common mode	Mains power quality should be that of a typical commercial or hospital environment.
Voltage dips, short interruptions and voltage variations on power supply input lines IEC 61000-4-11	<5% $U_T$ (>95% dip in $U_T$ ) for 0.5 cycle  40% $U_T$ (60% dip in $U_T$ ) for 5 cycles  70% $U_T$ (30% dip in $U_T$ ) for 25 cycles  <5% $U_T$ (>95% dip in $U_T$ ) for 5 sec	<5% $U_T$ (>95% dip in $U_T$ ) for 0.5 cycle  40% $U_T$ (60% dip in $U_T$ ) for 5 cycles  70% $U_T$ (30% dip in $U_T$ ) for 25 cycles  <5% $U_T$ (>95% dip in $U_T$ ) for 5 sec	Mains power quality should be that of a typical commercial or hospital environment. If the user of the X Series unit requires continued operation during power mains interruptions, it is recommended that the X Series unit be powered from an uninterruptible power supply or a battery.
Power frequency (50/60 Hz) magnetic field IEC 61000-4-8	30 A/m	30 A/m	Power frequency magnetic fields should be at levels characteristic of a typical location in a typical commercial or hospital environment.
<b>Note:</b> $U_T$ is the AC mains voltage prior to application of the test level.			

### Caution

In extreme cases, ESD events have the capability to reset the X Series unit. In the case of a system reset it may be necessary to re-zero the IBP channels, recharge the Defibrillator, or restart Pacing. If ECG or temperature monitoring fail due to an ESD event, the system may require a power cycle to restart those features.

## Electromagnetic Immunity

Guidance and manufacturer's declaration – electromagnetic immunity			
The functions of the X Series are intended for use in the electromagnetic environment specified below. The customer or user of the X Series should ensure that it is used in such an environment.			
Immunity test	IEC 60601 test level	Compliance level	Electromagnetic environment – guidance
Conducted RF IEC 61000-4-6	3 Vrms 150 kHz to 80 MHz outside ISM bands <sup>a</sup>	3 Vrms	Portable and mobile RF communications equipment should be used no closer to any part of the X Series, including cables, than the recommended separation distance calculated from the equation applicable to the frequency of the transmitter.  <b>Recommended separation distance</b>  $d = 1.2 \sqrt{P}$
	10 Vrms 150 kHz to 80 MHz in ISM bands <sup>a</sup>	10 Vrms	
Radiated RF IEC 61000-4-3 (ECG monitoring from PADS and SpO2)	10 V/m 80 MHz to 2.5 GHz	10 V/m	$d = 1.2 \sqrt{P}$ 80 MHz to 800 MHz $d = 2.3 \sqrt{P}$ 800 MHz to 2.7 GHz
Radiated RF IEC 61000-4-3 (EtCO2, NIBP, Temp)	20 V/m 80 MHz to 2.7 GHz	20 V/m	$d = 0.6 \sqrt{P}$ 80 MHz to 800 MHz $d = 1.2 \sqrt{P}$ 800 MHz to 2.7 GHz
Radiated RF IEC 61000-4-3 (all other functions)	10 V/m 80 MHz to 2.7 GHz	20 V/m	$d = 0.6 \sqrt{P}$ 80 MHz to 800 MHz $d = 1.2 \sqrt{P}$ 800 MHz to 2.7 GHz  where P is the maximum output power rating of the transmitter in watts according to the transmitter manufacturer and d is the recommended separation distance in meters. <sup>b</sup> Field strengths from fixed RF transmitters, as determined by electromagnetic site survey, <sup>c</sup> should be less than the compliance level in each frequency range. <sup>d</sup> Interference may occur in the vicinity of equipment marked with the following symbol:  
NOTE 1: At 80 MHz and 800 MHz, the higher frequency range applies.			
NOTE 2: These guidelines may not apply in all situations. Electromagnetic propagation is affected by absorption and reflection from structures, objects, and people.			

a. The ISM (industrial, scientific, and medical) bands between 150 kHz and 80 MHz are 6.765 MHz to 6.795 MHz; 13.553 MHz to 13.567 MHz; 26.957 MHz to 27.283 MHz; and 40.66 MHz to 40.70 MHz.

- b. The compliance levels in the ISM frequency bands between 150 kHz and 80 MHz and in the frequency range 80 MHz to 2.7 GHz are intended to decrease the likelihood that mobile/portable communications equipment could cause interference if it is inadvertently brought into patient areas. For this reason, an additional factor of 10/3 is used in calculating the recommended separation distance for transmitters in these frequency ranges.
- c. Field strengths from fixed transmitters, such as base stations for radio (cellular/cordless) telephones and land mobile radios, amateur radio, AM and FM radio broadcast and TV broadcast cannot be predicted theoretically with accuracy. To assess the electromagnetic environment due to fixed RF transmitters, an electromagnetic site survey should be considered. If the measured field strength in the location in which the X Series is used exceeds the applicable RF compliance level above, the X Series should be observed to verify normal operation. If abnormal performance is observed, additional measures may be necessary, such as reorienting or relocating the X Series.
- d. Over the frequency ranges 150 kHz to 80 MHz field strength should be less than 3 V/m.

### Recommended Separation Distances from RF Equipment for the X Series Functions

<b>Recommended separation distances between portable and mobile RF communications equipment and the X Series</b>				
The functions of the X Series are intended for use in the electromagnetic environment in which radiated RF disturbances are controlled. The customer or user of the X Series can help prevent electromagnetic interference by maintaining a minimum distance between portable and mobile RF communications equipment (transmitters) and the X Series as recommended below, according to the maximum output power of the communications equipment.				
Rated maximum output power of equipment (in watts)	Separation distance according to frequency of transmitter (in meters) for ECG monitoring from leads			
	150 kHz to 80 MHz outside ISM bands	150 kHz to 80 MHz in ISM bands	80 MHz to 800 MHz	800 MHz to 2.7 GHz
	$d = 1.2 \sqrt{P}$	$d = 1.2 \sqrt{P}$	$d = 0.6 \sqrt{P}$	$d = 1.2 \sqrt{P}$
0.01	0.12	0.12	0.06	0.12
0.1	0.38	0.38	0.19	0.38
1	1.2	1.2	0.60	1.2
10	3.8	3.8	1.9	3.8
100	12	12	6	12
Rated maximum output power of equipment (in watts)	Separation distance according to frequency of transmitter (in meters) for ECG monitoring from pads and SpO <sub>2</sub>			
	150 kHz to 80 MHz outside ISM bands	150 kHz to 80 MHz in ISM bands	80 MHz to 800 MHz	800 MHz to 2.7 GHz
	$d = 1.2 \sqrt{P}$	$d = 1.2 \sqrt{P}$	$d = 1.2 \sqrt{P}$	$d = 2.3 \sqrt{P}$
0.01	0.12	0.12	0.12	0.23
0.1	0.38	0.38	0.38	0.73
1	1.2	1.2	1.2	2.3
10	3.8	3.8	3.8	7.3
100	12	12	12	23
Rated maximum output power of equipment (in watts)	Separation distance according to frequency of transmitter (in meters) for all other functions			
	150 kHz to 80 MHz	80 MHz to 800 MHz	800 MHz to 2.7 GHz	
	$d = 1.2 \sqrt{P}$	$d = 0.6 \sqrt{P}$	$d = 1.2 \sqrt{P}$	
0.01	0.12	0.02	0.04	
0.1	0.38	0.06	0.11	
1	1.2	0.18	0.35	
10	3.8	0.57	1.1	
100	12	1.8	3.5	

For transmitters rated at a maximum output power not listed above, the recommended separation distance  $d$  in meters can be determined using the equation applicable to the frequency of the transmitter, where  $P$  is the maximum output power rating of the transmitter in watts according to the transmitter manufacturer.

NOTE 1: At 80 MHz and 800 MHz, the separation distance for the higher frequency range applies.

NOTE 2: The ISM (industrial, scientific, and medical) bands between 150 kHz and 80 MHz are 6.765 MHz to 6.795 MHz; 13.553 MHz to 13.567 MHz; 26.957 MHz to 27.283 MHz; and 40.66 MHz to 40.70 MHz.

NOTE 3: An additional factor of 10/3 is used in calculating the recommended separation distances for transmitters in the ISM frequency bands between 150 kHz and 80 MHz and in the frequency range 80 MHz to 2.7 GHz to decrease the likelihood that mobile/portable communications equipment could cause interference if it is inadvertently brought into patient areas.

NOTE 4: These guidelines may not apply in all situations. Electromagnetic propagation is affected by absorption and reflection from structures, objects, and people.

## ECG Analysis Algorithm Accuracy

Sensitivity and specificity are expressions of ECG analysis algorithm performance when compared to ECG interpretation by a clinician or expert. Sensitivity refers to the algorithm's ability to correctly identify shockable rhythms (as a percentage of the total number of shockable rhythms). Specificity refers to the algorithm's ability to correctly identify non-shockable rhythms (as a percentage of the total number of non-shockable rhythms). The data in the following table summarizes the accuracy of the ECG analysis algorithm as tested against ZOLL's ECG Rhythm Database.

The algorithm sequence takes approximately 9 seconds and proceeds as follows:

- Divides the ECG rhythm into three-second segments.
- Filters and measures noise, artifact, and baseline wander.
- Measures baseline content ('waviness' at the correct frequencies — frequency domain analysis) of signal.
- Measures QRS rate, width, and variability.
- Measures amplitude and temporal regularity ('auto-correlation') of peaks and troughs.
- Determines if multiple 3 second segments are shockable then displays *SHOCK ADVISED* message.

## Clinical Performance Results

The performance of the incorporated analysis algorithm in a single analysis sequence satisfies the applicable requirements specified in IEC 60601-2-4 (sub-clause 201.7.9.3.103) and the recommendations by Kerber et al. (Circulation. 1997;95(6):1677).

**Table A-4. Clinical Performance Results with Standard Analysis Algorithm with Adult**

Rhythms	Sample Size	Performance Goal	Observed Performance	90% Lower Confidence Limit
<b>Shockable</b>		<b>Sensitivity</b>		
Coarse VF	536	>90%	>99%	>99%
Rapid VT	80	>75%	>98%	>94%
<b>Non-shockable</b>		<b>Specificity</b>		
NSR	2210	>99%	>99%	>99%
AF, SB, SVT, Heart block, idioventricular, PVCs	819	>95%	>99%	>99%
Asystole	115	>95%	>99%	>97%
<b>Intermediate</b>			<b>Sensitivity</b>	
Fine VF	69	Report Only	>90%	>85%
Other VT	28	Report Only	>98%	>85%

	Shockable	Non-shockable
Shock	680	3
No Shock	5	3169



Table A-5. Clinical Performance Results with Standard Analysis Algorithm with Pediatric Patients

Rhythms	Sample Size	Performance Goal	Observed Performance	90% Lower Confidence Limit
<b>Shockable</b>		<b>Sensitivity</b>		
Coarse VF	42	>90%	>99%	>93%
Rapid VT	79	>75%	>99%	>96%
<b>Non-shockable</b>		<b>Specificity</b>		
NSR	208	>99%	>99%	>98%
AF, SB, SVT, Heart block, idioventricular, PVCs	348	>95%	>99%	>98%
Asystole	29	>95%	>99%	>90%
<b>Intermediate</b>			<b>Sensitivity</b>	
Fine VF	0	Report Only	NA	NA
Other VT	44	Report Only	>80%	>69%

	Shockable	Non-shockable
Shock	121	10
No Shock	0	619

**Table A-6. Clinical Performance Results with RapidShock**

Rhythms	Sample Size	Performance Goals	Observed Performance	90% Lower Confidence Limit
<b>Shockable</b>		<b>Sensitivity</b>		
Coarse VF	342	>90%	>98%	>97%
Rapid VT	58	>75%	>98%	>94%
<b>Non-shockable</b>		<b>Specificity</b>		
NSR	419	>99%	>99%	>99%
AF, SB, SVT, Heart block, idioventricular, PVCs	1631	>95%	>99%	>98%
Asystole	841	>95%	>99%	>99%
<b>Intermediate</b>			<b>Sensitivity</b>	
Fine VF	50	Report only	>92%	>82%
Other VT	51	Report only	>96%	>88%

	Shockable	Non-shockable
Shock	442	17
No Shock	8	2925

**References:**

Young KD, Lewis RJ: “What is confidence? Part 2: Detailed definition and determination of confidence intervals”. Annals of Emergency Medicine, September 1997; 30; 311-218

William H. Beyer, Ph.D.: “CRC Standard Mathematical Tables 28<sup>th</sup> Edition,” CRC Press, Inc, Boca Raton, FL., 1981, Percentage Points, F-Distribution Table, pg 573.

---

## Shock Conversion Estimator

Use of a defibrillator shock is currently the best option for terminating ventricular fibrillation and restoring a life sustaining ECG rhythm [1]. Maintaining blood flow through the heart via cardiopulmonary resuscitation (CPR) has been shown to improve the chances of a successful defibrillation [1]. The cessation of blood flow through the heart that occurs when CPR is stopped decreases the likelihood of a successful shock in proportion to the amount of time that has elapsed without CPR [1]. The repeated use of defibrillator shocks that do not restore a life sustaining rhythm may cause additional damage to the myocardium and reduce the patient's chances for survival. The use of an accurate shock outcome predictor can help reduce the duration of CPR interruptions and the number of ineffective (non-converting) shocks delivered.

Properly performed CPR has been shown to increase blood flow to the heart and increase the neurologically intact patient survival rate [2]. The rescuer must stop CPR while the patient's rhythm is analyzed to determine whether it is shockable. If the rhythm can be identified as unlikely to convert, CPR can be resumed faster rather than delivering ineffective shocks. This reduction in total shocks delivered reduces the damage sustained by the heart during resuscitation.

The Shock Conversion Estimator (SCE) is applied to the analysis result. SCE computes a Shock Prediction Index (SPI) number which measures the probability that a shockable rhythm will be successfully converted by immediate defibrillation. The SPI number is directly related to the AMSA measure developed by the Weil Institute of Critical Care Medicine [3].

The Shock Conversion Estimator algorithm was developed and tested using data collected from a registry of ZOLL AED Pro® and AED Plus® defibrillator field cases. Since the AED Pro and AED Plus defibrillators are first responder units, all patient records correspond to first responder cardiac arrest situations. The defibrillator shock results from these cases were annotated as “converted” if a transient return of spontaneous circulation (tROSC) occurred following the shock. tROSC was defined as post shock ECG rhythms meeting both of the following characteristics:

1. Spontaneous ECG rhythms lasting at least 30 seconds that began within 60 seconds after shock delivery; and
2. Rhythms exhibiting a heart rate of 40 beats per minute or more.

The post shock rhythm was annotated as “non-converted” if it exhibited any other conversion outcome, e.g. VF, VT, and asystole.

The development database consisted of 149 patients containing 335 shocks. The SPI threshold of 4.5mV-Hz was selected to achieve sensitivity of 95% in development database.

The testing database consisted of 320 patient records containing 698 shocks. When evaluated against the testing database the threshold of 4.5mV-Hz resulted in sensitivity and specificity of 96% and 50% respectively.

The preferred treatment for non-converting rhythms may be the delivery of aggressive CPR. The use of the SPI measure to determine when shock treatments are likely to succeed will help minimize time between the advisory decision and the start of CPR. Minimizing non-perfusing time during resuscitation is a key contributor to improving patient outcomes [4].

$$\text{Sensitivity} = \frac{\text{Number of ECG Rhythms with SPI} \geq \text{Threshold that were successfully converted}}{\text{Total number of ECG rhythms that were successfully converted}}$$

$$\text{Specificity} = \frac{\text{Number of ECG rhythms with SPI} < \text{Threshold that did not convert}}{\text{Total number of ECG rhythms that did not convert}}$$

**References:**

[1] Eftestol T, Sunde K, Steen PA. Effects of Interrupting Precordial Compressions on the Calculated Probability of Defibrillation Success during Out-of-Hospital Cardiac Arrest. *Circulation* 2002; 105:2270-2273.

[2] Sota Y, Weil MH, Sun S, Tang W, Xie J, Noc M, Bisera J. Adverse effects of interrupting precordial compression during cardiopulmonary resuscitation. *Critical Care Medicine* 1997; 25:733-736.

[3] Young C, Bisera J, Gehman S, Snyder D, Tang W, Weil MH. Amplitude spectrum area: measuring the probability of successful defibrillation as applied to human data. *Critical Care Medicine* 2004; 32:S356-S358.

[4] Wik L. Rediscovering the importance of chest compressions to improve the outcome from cardiac arrest. *Resuscitation* 2003; 58:267-269.

# Wireless Output Guidance and Manufacturer's Declaration

## RF Transmission Emitted (IEC 60601-1-2)

The X Series unit complies with IEC 60601-1-2 for medical electrical equipment and medical electrical systems that include RF transmitters as specified below.

Standard	Frequency Range	Effective Radiated Power	Modulation Type	Data Rates
802.11b	2412-2472 MHz	100 mW	DSSS	1, 2, 5.5, 11 Mbps
802.11g	2412-2472 MHz	32 mW	OFDM	6, 9, 12, 24, 36, 48, 54 Mbps
802.11n	2412-2472 MHz	32 mW	OFDM	6.5, 13, 19.5, 26, 39, 52, 58.5, 65 Mbps
Bluetooth	2400-2483.5 MHz	10 mW	FHSS; GFSK/ DQPSK/8DPSK	1, 3 Mbps
802.11a	5180-5320 MHz 5500-5700 MHz 5745-5825 MHz	32 mW	OFDM	6, 9, 12, 24, 36, 48, 54 Mbps
802.11n	5180-5320 MHz 5500-5700 MHz 5745-5825 MHz	32 mW	OFDM	6.5, 13, 19.5, 26, 39, 52, 58.5, 65 Mbps

## FCC Notice

ZOLL Medical Corporation has not approved any changes or modifications to this device by the user. Any changes or modifications could void the user's authority to operate the equipment. See 47 CFR Section 15.21.

This device complies with part 15 of the FCC Rules. Operation is subject to the following two conditions: (1) This device may not cause harmful interference, and (2) this device must accept any interference received, including interference that may cause undesired operation. See 47 CFR Section 15.19(a)(3).

The user is cautioned to maintain 20cm (8 inches) of space from the product to ensure compliance with FCC requirements.

This device is limited to indoor use in the 5150 MHz to 5250 MHz band.

**Note:** Harmful Interference is defined by the FCC as follows:  
Any emission, radiation or induction that endangers the functioning of a radio navigation service or of other safety services or seriously degrades, obstructs or repeatedly interrupts a radio communications service operating in accordance with FCC rules.

## Canada, Industry Canada (IC) Notices

This device complies with Industry Canada license-exempt RSS standard(s). Operation is subject to the following two conditions: (1) this device may not cause interference, and (2) this device must accept any interference, including interference that may cause undesired operation of the device.



# Appendix B

## Accessories

---

The following accessories are compatible for use with the X Series unit. To order any of these items, contact your local ZOLL representative.

<b>ECG Accessories</b>
ECG, 3-Lead Cable, AAMI
ECG, 3-Lead Cable, IEC
ECG, 5-Lead Cable, AAMI
ECG, 5-Lead Cable, IEC
ECG, 12-Lead "Breakaway" Patient Cable Complete (Trunk Cable, 4-lead wire set with detachable 6 "V" precordial lead wire set), AAMI
ECG, 12-Lead "Breakaway" Patient Cable Complete (Trunk Cable, 4-lead wire set with detachable 6 "V" precordial lead wire set), IEC
ECG, 4-Lead "Breakaway" Trunk Cable and 4 lead wire set only, AAMI
ECG, 4-Lead "Breakaway" Trunk Cable and 4 lead wire set only, IEC
ECG, Detachable 6 precordial lead wire set for "Breakaway" 12-Lead Patient Cable, AAMI
ECG, Detachable 6 precordial lead wire set for "Breakaway" 12-Lead Patient Cable, IEC

<b>CO<sub>2</sub> Accessories (Oridion Filterlines)</b>
Smart CapnoLine Plus, Non-intubated filterline with O <sub>2</sub> Delivery, Adult, box of 25
Smart CapnoLine Plus, Non-intubated filterline with O <sub>2</sub> Delivery, Pediatric, box of 25
FilterLine H Set, Adult/Pediatric, box of 25
FilterLine H Set, Infant/Neonate, box of 25
FilterLine Set, Adult/Pediatric, box of 25
VitaLine H set Adult/Pediatric, box of 25
<b>NIBP Accessories</b>
<b>Hoses</b>
Hose, Infant/Neonate, 8', w/ female luer cuff connector, single lumen
Hose, Adult/Pediatric, 10', w/ "twist lock" cuff connector, dual lumen
Hose, Adult/Pediatric, 5', w/ "twist lock" cuff connector, dual lumen
<b>Reusable Cuffs (Welch Allyn Blood Pressure Flexiport Cuffs)</b>
Neonate #1, 3.3 - 5.6 cm single tube w/ male luer connector, box of 10
Neonate #2, 4.2 - 7.1 cm single tube w/ male luer connector, box of 10
Neonate #3, 5.4 - 9.1 cm single tube w/ male luer connector, box of 10
Neonate #4, 6.9 - 11.7 cm single tube w/ male luer connector, box of 10
Neonate #5, 8.9 - 15.0 cm single tube w/ male luer connector, box of 10
Neonatal Cuff Kit, one each of sizes #1 - #5, single tube w/ male luer connector, bag of 5
Welch Allyn REUSE-07-2MQ Cuff, Infant, 2-Tube, Twist lock connector
Welch Allyn REUSE-08-2MQ Cuff, Small Child, 2-Tube, Twist lock connector
Welch Allyn REUSE-09-2MQ Cuff, Child, 2-Tube, Twist lock connector
Welch Allyn REUSE-10-2MQ Cuff, Small Adult, 2-Tube, Twist lock connector
Welch Allyn REUSE-11-2MQ Cuff, Adult, 2-Tube, Twist lock connector
Welch Allyn REUSE-11L-2MQ Cuff, Adult Long, 2-Tube, Twist lock connector
Welch Allyn REUSE-12-2MQ Cuff, Lg Adult, 2-Tube, Twist lock connector
Welch Allyn REUSE-12L-2MQ Cuff, Lg Adult Long, 2-Tube, Twist lock connector
Welch Allyn REUSE-13-2MQ Cuff, Thigh, 2-Tube, Twist lock connector



<b>SpO<sub>2</sub> Accessories</b>
Rainbow R25, Single use sensor for patients > 30 kg
Rainbow R25-L, Single use sensor for patients < 3kg, > 30 kg
Rainbow R20, Single use sensor for Pediatrics 10 - 50 kg
Rainbow R20-L, Single use sensor for Infants 3 - 10 kg
Rainbow Patient Cable RC-4, 4' Reusable Patient Cable
Rainbow Patient Cable RC-12, 12' Reusable Patient Cable
Rainbow DCI-dc8, 8' Adult Reusable Patient Cable / Sensor
Rainbow DCI-dc12, 12' Adult Reusable Patient Cable / Sensor
Rainbow DCIP-dc8, 8' Pediatric Reusable Patient Cable / Sensor
Rainbow DCIP-dc12, 12' Pediatric Reusable Patient Cable / Sensor
Red DBI-dc8, 8' Reusable Direct Connect Sensor, Masimo Rainbow Set
Rainbow DCI SC-200 Adult Reusable Finger Sensor (SpHb, SpMet, SpO <sub>2</sub> ), 3 ft. Sensor includes 200 SpHb Tests.
Rainbow DCI SC-200 Pediatric Reusable Finger Sensor (SpHb, SpMet, SpO <sub>2</sub> ), 3 ft. Sensor includes 200 SpHb Tests.
Rainbow DCI SC-400 Adult Reusable Finger Sensor (SpHb, SpMet, SpO <sub>2</sub> ), 3ft. Sensor includes 400 SpHb Tests.
Rainbow DCI SC-400 Pediatric Reusable Finger Sensor (SpHb, SpMet, SpO <sub>2</sub> ), 3ft. Sensor includes 400 SpHb Tests.
Rainbow R1-25L Adult Adhesive Sensors - SpHb, SpO <sub>2</sub> , SpMet box of 10
Rainbow R1-20L Infant Adhesive Sensors - SpHb, SpO <sub>2</sub> , SpMet box of 10
Rainbow R1-25 Butterfly Adult Adhesive Sensors (SpHb, SpO <sub>2</sub> , SpMet) box of 10
Rainbow R1-20 Butterfly Pediatric Adhesive Sensors (SpHb, SpO <sub>2</sub> , SpMet) box of 10
M-LNCS™ ADTX, Adult SpO <sub>2</sub> adhesive sensor, > 30 kg. Single-patient use only
M-LNCS™ Pdtx-3, Pediatrics SpO <sub>2</sub> adhesive sensor, 3 ft. cable, 10-50 kg. Single-patient use only
M-LNCS™ NeoPt-3, Neonatal SpO <sub>2</sub> adhesive sensor, 3 ft. cable, < 1 kg. Single-patient use only
M-LNCS™ Inf-3, Infant SpO <sub>2</sub> adhesive sensor, 3 ft. cable, 3-20 kg. Single-patient use only
<b>Temperature Accessories</b>
YSI Reusable Adult, Skin Probe
YSI Reusable Pediatric, Skin Probe
YSI Reusable Adult, Esophageal/Rectal
YSI Reusable Pediatric, Esophageal/Rectal

Sensor Adapter Cable for Disposable Probes
YSI Disposable Esophageal/Rectal Probe
YSI Disposable Skin Probe
<b>Defibrillation Accessories</b>
X Series Multifunction Therapy Cable - allows use of disposable multifunction electrodes and ZOLL M Series CCT External and Internal paddles (sold separately)
M Series External Paddles set with controls and built-in pediatric electrodes
ZOLL Sterilizable Internal Handle (black), with Switch, 1.0" spoon, 10' cable (US only) or 7' cable
ZOLL Sterilizable Internal Handle (black), with Switch, 1.6" spoon, 10' cable (US only) or 7' cable
ZOLL Sterilizable Internal Handle (black), with Switch, 2.0" spoon, 10' cable (US only) or 7' cable
ZOLL Sterilizable Internal Handle (black), with Switch, 2.7" spoon, 10' cable (US only) or 7' cable
ZOLL Sterilizable Internal Handle (black), with Switch, 3.0" spoon, 10' cable (US only) or 7' cable
ZOLL Sterilizable Internal Handle (black), without Switch, 1.0" spoon, 10' cable
ZOLL Sterilizable Internal Handle (black), without Switch, 1.6" spoon, 10' cable
ZOLL Sterilizable Internal Handle (black), without Switch, 2.0" spoon, 10' cable
ZOLL Sterilizable Internal Handle (black), without Switch, 2.7" spoon, 10' cable
ZOLL Sterilizable Internal Handle (black), without Switch, 3.0" spoon, 10' cable
ZOLL Defibrillation Gel
ZOLL OneStep cable
ZOLL Multifunction Therapy Cable with CPR-D connector
ZOLL Multifunction Therapy Cable CPRD Adapter
CPR Stat-padz HVP Multifunction CPR Electrodes - 8 pair/case
CPR Stat-padz HVP Multifunction CPR Electrodes - 1 pair
Electrode, Pedi-padz II, NO OVERBOX, single
Electrode, Pedi-padz II, NO OVERBOX, 6/case
OneStep Resuscitation Electrode (8 per case)
OneStep Pacing Resuscitation Electrode (8 per case)
OneStep CPR Resuscitation Electrode (8 per case)
OneStep Complete Resuscitation Electrode (8 per case)
OneStep CPR AA Electrode (8 per case)
Electrodes, OneStep Basic, Single, R Series
Electrodes, OneStep Pacing, Single, R Series
Electrodes, OneStep CPR, Single, R Series

Electrodes, OneStep Complete, Single, R Series
Electrodes, OneStep CPR AA, Single
Electrodes, OneStep Pediatric
Electrodes, OneStep Pediatric with CPR
Electrodes, OneStep BASIC, Single
CPR-D•padz One Piece Electrode Pad With Real CPR Help
Electrodes, CPR-D-padz w/o Accessory Kit
Set of 12 electrodes, Stat-padz
Single, Stat-padz
<b>IBP Accessories</b>
Interface cable – Abbott
Interface cable - Edwards
s: 5 $\mu$ V/mm Hg, IEC 60601-2-34 and AAMI BP-22 compliant
<b>Compatible IBP Transducers</b>
Abbott Transpac <sup>®</sup> IV
Edwards Truwave <sup>®</sup>
To purchase these transducers, contact your local Abbott or Edwards distributor.
<b>CPR Accessories</b>
CPR-D-padz
CPR-Stat-padz
CPRD-to-Multifunction Therapy Cable Adapter
Stat-padz
Pedi-padz II
OneStep electrodes
<b>Power Accessories</b>
ZOLL SurePower II Rechargeable Battery
SurePower Charger Station
SurePower II Battery Charger X Series Battery Adapter
AC Auxiliary Power Adapter, 8300-0004
DC Auxiliary Power Adapter, 8300-000006
Replacement Power Cord – U.S.

Replacement Power Cord – Japan
<b>Other Accessories</b>
X Series Soft Carrying Case
X Series Backpack
ECG 80 mm Chart Recorder Paper
Cable adapter, USB to Ethernet
USB Cable Extension
X Series Multi-Tech Cell Modem; GSM Version
X Series Multi-Tech Cell Modem; CDMA Version
X Series Multi-Tech Cell Modem External Antenna Kit, GSM Version
X Series Pre-Grid Paper

# ZOLL®

## R Series® PLUS      R Series® BLS

---

# Operator's Guide



The issue date for the R Series Operator's Guide BLS/Plus (**REF 9650-0904-01 Rev. U**) is **December, 2017**.

Copyright © 2017 ZOLL Medical Corporation. All rights reserved.

R Series, M Series, Pedi-padz, Pro-padz, Stat-padz, CodeNet, Real CPR Help, RescueNet, See-Thru CPR, Code-Ready, SurePower, OneStep, Smart Alarms, Perfusion Performance Indicator, Defib Mentor, Rectilinear Biphasic, and ZOLL are trademarks or registered trademarks of ZOLL Medical Corporation in the United States and/or other countries.

Masimo is a registered trademark of Masimo Corporation in the United States and/or other countries.

All other trademarks are property of their respective owners.

Caution: Federal law restricts this device to sale by or on the order of a licensed practitioner.



**ZOLL Medical Corporation**  
269 Mill Road  
Chelmsford, MA USA  
01824-4105



**ZOLL International Holding B.V.**  
Newtonweg 18  
6662 PV ELST  
The Netherlands



0123

## Defibrillator Function

The R Series system is indicated for defibrillation on victims of cardiac arrest where there is apparent lack of circulation as indicated by:

- Unconsciousness.
- Absence of breathing.
- Absence of pulse.

The R Series system in the Manual mode is indicated for synchronized cardioversion of certain atrial or ventricular arrhythmias. A qualified physician must decide when synchronized cardioversion is appropriate.

The R Series system Semiautomatic and Manual mode is indicated for use in early defibrillation programs where the delivery of a defibrillator shock during resuscitation involving CPR, transportation, and definitive care are incorporated into a medically-approved patient care protocol.

The R Series system Semiautomatic and Manual mode is indicated for adult and pediatric patients.

## ECG Monitoring

The R Series system is indicated to evaluate the patient's heart rate or ECG morphology via ECG monitoring. In ECG monitoring mode, the feature is indicated for use by personnel who are qualified by training in the use of the R Series defibrillator, basic life and/or advanced life support, or other physician-authorized emergency medical training.

## Real CPR Help

The R Series system is indicated to provide visual and audio feedback via the CPR Help feature, which is designed to encourage rescuers to perform chest compressions at the AHA/ERC recommended depth and rate of 2 inches (5 cm) and 100 compressions per minute.

## External Pacemaker

The R Series system is indicated for temporary external cardiac pacing in conscious or unconscious patients as an alternative to endocardial stimulation. External Pacing is indicated for pediatric and adult patients.

## SpO<sub>2</sub> Monitoring

The R Series system is indicated for the continuous, noninvasive monitoring of arterial oxygen saturation (SpO<sub>2</sub>) and pulse rate during both no motion and patient motion conditions for adult patients, and no motion conditions for pediatric and neonatal patients in a hospital or prehospital environment.

## EtCO<sub>2</sub> Monitoring

The R Series system is indicated for the continuous noninvasive monitoring of end tidal carbon dioxide (EtCO<sub>2</sub>) and respiration rate in patients requiring ventilator support, in-hospital transport, or anesthesia. EtCO<sub>2</sub> Monitoring is indicated for in patients from newborn (neonate) to adult.

## Non-Invasive Blood Pressure Monitoring (NIBP)

The R Series system is indicated for the non-invasive measurement of arterial blood pressure for resting patients in critical care and in-hospital transport. The NIBP feature is indicated to measure blood pressure for patients from newborn (neonate) to adult.

---

## CONTRAINDICATIONS

### **The R Series Semiautomatic Operation Contraindications for Use**

The rhythm analysis function may not reliably identify ventricular fibrillation in the presence of an implanted pacemaker. Inspection of the electrocardiogram and clinical evidence of cardiopulmonary arrest should be the basis for any treatment of patients with implanted pacemakers. Do not use the rhythm analysis function during patient movement on a stretcher. A patient must be motionless during ECG analysis. Do not touch the patient during analysis. Cease all movement of the stretcher prior to analyzing the ECG.

### **General Information**

Federal (U.S.A.) law restricts this defibrillator to sale by or on the order of a physician.



# Table of Contents

Defibrillator Function .....	iii
ECG Monitoring .....	iii
Real CPR Help .....	iii
External Pacemaker .....	iii
SpO <sub>2</sub> Monitoring .....	iii
EtCO <sub>2</sub> Monitoring .....	iii
Non-Invasive Blood Pressure Monitoring (NIBP) .....	iii
CONTRAINDICATIONS .....	iv
General Information .....	iv

## Chapter 1 General Information

Product Description .....	1-1
R Series Model Features .....	1-3
How to Use This Manual.....	1-4
Operator's Guide Updates.....	1-4
Unpacking.....	1-4
Symbols Used on the Equipment .....	1-4
Conventions.....	1-7
Defibrillator Function.....	1-7
Intended Use — Manual Operation .....	1-8
Intended Use — Semiautomatic Operation (AED) .....	1-8
Intended Use — ECG Monitoring .....	1-8
Intended Use — Real CPR Help .....	1-8
Defibrillator Complications .....	1-8
Defibrillator Output Energy .....	1-9
External Pacemaker (Optional).....	1-9
Intended Use — Pacemaker .....	1-9
Pacemaker Complications .....	1-10
Pediatric Pacing .....	1-11
Intended Use — SpO <sub>2</sub> Monitoring .....	1-11
Intended Use — EtCO <sub>2</sub> Monitoring.....	1-11
Intended Use — NIBP.....	1-12
ECG Monitoring .....	1-12
Recorder Function (Manual Mode Only).....	1-13
Paddles and Electrodes.....	1-13
Batteries.....	1-14
Code-Ready System.....	1-14
Safety Considerations.....	1-15

Warnings.....	1-15
Operator Safety .....	1-17
Patient Safety .....	1-18
Cautions.....	1-19
Restarting the Defibrillator .....	1-19
FDA Tracking Requirements.....	1-20
Notification of Adverse Events .....	1-20
Software License .....	1-21
Service.....	1-21
The ZOLL Serial Number.....	1-23

## Chapter 2 Product Overview

Defibrillator Controls and Indicators.....	2-1
The Front Panel .....	2-3
Display Screen .....	2-6
Patient Cables and Connectors .....	2-8
External Paddles (Manual Mode Only) .....	2-10
Working with Menus (Manual Mode Only).....	2-12
Common Tasks .....	2-13
Replacing a Battery Pack .....	2-13
Adjusting Display Brightness (Manual Mode Only) .....	2-14
Using Code Markers (Manual Mode Only) .....	2-14

## Chapter 3 Automated External Defibrillator (AED) Operation

AED Operation.....	3-2
Determine Patient Condition Following Medical Protocols .....	3-2
Begin CPR Following Medical Protocols .....	3-2
Prepare Patient .....	3-2
1 Select ON .....	3-4
2 Analyze .....	3-5
3 Press SHOCK .....	3-6
Operating Messages .....	3-8
Audio and Display Messages .....	3-8
Switching to Manual Mode Operation.....	3-10

## Chapter 4 Manual Defibrillation

Emergency Defibrillation Procedure with Paddles.....	4-1
Determine the Patient's Condition Following Local Medical Protocols .....	4-1
Begin CPR Following Local Medical Protocols .....	4-2
1 Select ON .....	4-2
2 Charge Defibrillator .....	4-4
3 Deliver Shock .....	4-5
Autoclavable External Paddles .....	4-5

---

Emergency Defibrillation Procedure with Hands-Free Therapy Electrodes .....	4-6
Determine the Patient's Condition Following Local Medical Protocols .....	4-6
Begin CPR Following Medical Protocols .....	4-6
Prepare Patient .....	4-6
1 Select ON .....	4-8
2 Charge Defibrillator .....	4-9
3 Deliver Shock .....	4-10
Autoclavable Electrodes .....	4-10

## Chapter 5 Advisory Defibrillation

Advisory Defibrillation Procedure .....	5-2
Determine the Patient's Condition Following Local Medical Protocols .....	5-2
Begin CPR Following Local Medical Protocols .....	5-2
Prepare Patient .....	5-2
1 Select ON .....	5-2
2 Press ANALYZE Button .....	5-4
3 Press SHOCK .....	5-5
Advisory Function Messages .....	5-7
Warning Messages .....	5-7

## Chapter 6 Synchronized Cardioversion

Synchronized Cardioversion Procedure .....	6-2
Determine the Patient's Condition and Provide Care Following Local Medical Protocols .....	6-2
Prepare Patient .....	6-2
1 Select ON .....	6-3
2 Charge Defibrillator .....	6-4
3 Deliver SHOCK .....	6-5
Remote Synchronized Cardioversion Procedure .....	6-5
Determine the Patient's Condition and Provide Care Following Local Medical Protocols .....	6-6
Prepare Patient .....	6-6
1 Select ON .....	6-6
2 Charge Defibrillator .....	6-7
3 Deliver SHOCK .....	6-7

## Chapter 7 Real CPR Help

Real CPR Help Field .....	7-2
Perfusion Performance Indicator (R Series Plus/Adult Only) .....	7-2
CPR Idle Time Display .....	7-2
CPR Rate and Depth Display .....	7-2
Compression Release Bar (R Series Plus/Adult only) .....	7-3
CPR Metronome .....	7-3
Fully Release prompt .....	7-4
CPR Voice Prompts (R Series Plus/Adult only) .....	7-4

Chest Compressions Bar Graph (Manual Mode Only) ..... 7-4  
 Displaying the CPR Bar Graph (Manual Mode Only) ..... 7-4

**Chapter 8 See-Thru CPR (R Series Plus Only)**

Using See-Thru CPR (R Series Plus Only) ..... 8-2  
 Examples ..... 8-2

**Chapter 9 Noninvasive Temporary Pacing (Optional)**

Noninvasive Temporary Pacing ..... 9-2  
     Determine Patient Condition and Provide Care Following Local Medical Protocols ... 9-2  
     Prepare the Patient ..... 9-2  
         1 Apply ECG Electrodes/Hands-Free Therapy Electrodes ..... 9-2  
             1 Select ON ..... 9-3  
             2 Turn Mode Selector to PACER ..... 9-4  
             3 Set Pacer Rate ..... 9-4  
             4 Set Pacer Output ..... 9-5  
             5 Determine Capture ..... 9-5  
             6 Determine Optimum Threshold ..... 9-6  
     Special Pacing Applications ..... 9-8  
         Standby Pacing ..... 9-8  
         Asynchronous Pacing ..... 9-8  
             1 Select ON ..... 9-9  
             2 Turn Mode Selector to PACER ..... 9-9  
         Press the Async Pacing On/Off softkey ..... 9-10  
         Pediatric Pacing ..... 9-10

**Chapter 10 ECG Monitoring**

Preparations ..... 10-2  
 Electrode Placement..... 10-2  
 Monitoring Electrodes Attachment ..... 10-3  
 Monitoring the Patient’s ECG..... 10-4  
     Set the Controls ..... 10-4  
 Implanted Pacemakers ..... 10-5  
 5-Lead Monitoring ..... 10-7  
     Simultaneous 3-Lead Printing ..... 10-7  
     See-Thru CPR Filter (R Series Plus Only) ..... 10-7  
     Adding Traces to Be Displayed ..... 10-8  
 Printing the ECG on a Stripchart ..... 10-8  
     Diagnostic Bandwidth ..... 10-8

---

Alarms.....	10-9
Setting Alarm Limits .....	10-9
Heart Rate Alarm Limits .....	10-10
Vital Sign Alarms .....	10-10
Suspending and Silencing Alarms .....	10-10
Smart Alarms .....	10-11
Alarm Settings for Unattended Monitoring .....	10-12

## Chapter 11 Event Records and Reports

Summary Report.....	11-1
Summary Report Formats .....	11-2
Printing the Entire Summary Report .....	11-7
Printing a Partial Summary Report .....	11-8
Full Disclosure Recording.....	11-8
Incident Logs .....	11-8
Printing an Incident Log .....	11-8
Erasing Summary Report and Full Disclosure .....	11-9
Manual Erasure .....	11-9
Automatic Erasure .....	11-9
Formatting the Disk .....	11-9
Related Messages .....	11-10

## Chapter 12 File Transfer

Transferring Files to an External Device.....	12-1
Wi-Fi (Optional).....	12-2
Installing or Removing a Compact Flash Card .....	12-2
Transferring a Full Disclosure File to a Compact Flash Card.....	12-3
Transferring Device Check and Activity Log Files to a Compact Flash Card.....	12-4
Transferring Files Through the USB Port (R Series Plus Only) .....	12-4
Transferring Full Disclosure Files Through Wi-Fi (R Series Plus Only) .....	12-5
Transferring Device Check and Activity Log Files Through Wi-Fi (R Series Plus Only) ...	12-6
Related Wi-Fi Messages .....	12-7

## Chapter 13 Maintenance

Routine Procedures .....	13-2
Daily Visual Inspection .....	13-2
Code Readiness Test .....	13-3

Manual Defibrillator Testing.....	13-3
Defibrillator Testing with Paddles .....	13-4
Defibrillator Testing with Hands-Free Therapy Electrodes .....	13-5
Pacer Testing .....	13-6
Recorder Check .....	13-6
Code Readiness Log .....	13-7
Setting Time and Date .....	13-9
Cleaning the R Series Unit .....	13-9
Loading Stripchart Paper .....	13-10
Cleaning the Print Head .....	13-11
Operator’s Checklist for R Series Product .....	13-12

## Chapter 14 Troubleshooting

Code-Ready .....	14-1
Monitor .....	14-2
Recorder .....	14-4
Pacer .....	14-4
Defibrillator .....	14-5
AC Charger .....	14-8
CPR .....	14-8

## Appendix A Specifications

Defibrillator Specifications .....	A-2
Battery Pack Specifications .....	A-7
IEC 60601-1-2 Specifications .....	A-8
Electromagnetic Emissions Declaration .....	A-8
Electromagnetic Immunity Declaration (EID) .....	A-9
Electromagnetic Immunity .....	A-10
Recommended Separation Distances from RF Equipment for the R Series Functions .....	A-11
R Series Rectilinear Biphasic Waveform Characteristics .....	A-12
Clinical Trial Results for the Biphasic Waveform .....	A-24
Randomized Multicenter Clinical Trial for Defibrillation of Ventricular Fibrillation (VF) and Ventricular Tachycardia (VT) .....	A-24
Pre-Clinical Study .....	A-25
Published Clinical Data .....	A-26
Randomized Multi-Center Clinical trial for Cardioversion of Atrial Fibrillation (AF) ...	A-26
Synchronized Cardioversion of Atrial Fibrillation .....	A-28
ECG Rhythm Analysis Algorithm Accuracy .....	A-29

## Appendix B R Series Accessories

## Appendix C Wi-Fi Radio Module Information

# Chapter 1

## General Information

---

### Product Description

The ZOLL® R Series® products combine a defibrillator, ECG display, advanced monitoring capabilities, and Noninvasive Transcutaneous Pacing (NTP) with communication, data printing and recording capabilities in a single lightweight portable instrument. The unit has been designed for all resuscitation situations and its small, compact, lightweight design makes it ideal for accompanying patients during in-hospital transport. The product is powered by AC mains and an easily replaced battery pack that is quickly recharged in the device when it is connected to AC mains. In addition, the unit's battery may be recharged and tested using a ZOLL SurePower™ Battery Charger.

The product is designed for use only in the hospital. All of its ruggedized features add to its durability in hospital applications.

**The R Series comes in both R Series Plus and R Series BLS models. This guide documents all the features that are available in both models. Both models can also have the additional optional features of Pacing and SpO<sub>2</sub>.**

**The BLS model does not contain all of the functions that are included in the Plus model. The features that only apply to the Plus model are documented as *R Series Plus Only* within the manual, and optional features are documented as *Optional*.**

**Refer to the table on page 1-3 for a listing of features that are available in the R Series defibrillator models.**

The R Series is a versatile external defibrillator. The device powers up in AED mode automatically. Depending on local protocols, the device may start prompting the operator to *PERFORM CPR* or the device may start analyzing ECG automatically, prompt the operator to *STAND CLEAR*, charge the defibrillator (if appropriate), and prompt the operator to *PRESS SHOCK* in between periods of CPR. The device can be switched to Manual mode after power

up. When operating in the manual configuration, the device operates as a conventional defibrillator where the device's charging and discharging are fully controlled by the operator. In advisory mode, some of the features of the device are automated and a sophisticated algorithm is used to identify shockable ECG rhythms (VF and wide complex VT >150 bpm) that should be treated by defibrillator shock delivery. Depending on local protocols, the unit may be configured to automatically analyze the ECG, charge the defibrillator (if appropriate), and prompt the operator to *PRESS SHOCK* between periods of CPR.

The R Series unit assists caregivers during cardiopulmonary resuscitation (CPR) by evaluating the rate and depth of chest compressions and providing feedback to the rescuer.

Real CPR Help<sup>®</sup> requires the use of OneStep<sup>™</sup> CPR electrodes or OneStep<sup>™</sup> Complete electrodes. When using these pads, the displayed ECG waveforms can be adaptively filtered, using the See-Thru CPR<sup>®</sup> feature, to reduce the artifact caused by chest compressions.

The R Series is a Code-Ready<sup>®</sup> defibrillator. It extends testing beyond shock delivery and checks more than 40 measures of readiness, including the presence of the correct cables and electrodes, the type of electrode, and other important electronic functions. The R Series also verifies the condition and expiration date of OneStep electrodes. This code readiness testing can occur automatically, without disconnecting electrodes or paddles, or requiring additional equipment to test shock delivery. The system also provides a printed, or electronic log to alert hospital personnel of any defibrillator functions or accessories that are compromised in advance of a code.

Some R Series models include an optional transcutaneous pacemaker consisting of a pulse generator and ECG sensing circuitry. The pacing option supports both demand and asynchronous noninvasive pacing for adult, pediatric, or neonatal patients. OneStep<sup>™</sup> Pacing electrodes and OneStep Complete electrodes allow demand pacing and ECG monitoring without separate ECG electrodes when the R Series is used with the OneStep<sup>™</sup> Pacing cable.

Information regarding the unit's operation, ECG, and other physiological waveforms are displayed on a large 6.5 inch (16.5 cm) diagonal display which provides high contrast and visibility under virtually all lighting conditions. Operating and warning messages are displayed on the monitor, and the unit can also be configured with voice prompts to alert the user to unit status. The R Series performs code readiness testing when the unit is OFF but connected to AC power, when the defibrillator is initially turned on, and periodically during operation.

An annotating strip chart recorder is included to provide immediate documentation as well as summary report functions about patient care and treatment in Manual mode.

A sophisticated data collection system, including summary report, printer, and multiple communication ports is available for this unit. The stored data can be reviewed and archived on a properly equipped personal computer using ZOLL CodeNet<sup>®</sup> Central software or ZOLL RescueNet<sup>®</sup> Code Review software. R Series data files may be transferred to a PC using USB, Compact Flash cards or Wi-Fi.

R Series products are intended for use in either AED mode or Manual mode by personnel certified by appropriate federal, state, or local government authority to provide advanced life support care.



## R Series Model Features

The following features are available in the R Series Plus and R Series BLS models. Pacing and SpO2 monitoring are additional options that may be purchased separately.

Feature	BLS Model	Plus Model
Real CPR Help	✓	✓
See-Thru CPR		✓
Perfusion Performance Indicator™		✓
OneStep system	✓	✓
OneStep cable	✓	✓
OneStep ECG leads cable (3-lead set)		✓
OneStep Cable Manager		✓
Code Readiness testing system	✓	✓
Integrated hands free electrode mounting	✓	✓
Rectilinear Biphasic Waveform	✓	✓
Universal operating system	✓	✓
Defib activity log	✓	✓
Corrective voice prompts		✓
5.8 Ah rechargeable lithium-ion battery	✓	✓
3 lead ECG cable	✓	✓
90mm strip chart writer	✓	✓
Integrated AC power	✓	✓
Built-in test port	✓	✓
Compact Flash card slot	✓	✓
USB device port		✓
Wi-Fi communication software		✓
EtCO <sub>2</sub>		✓
NIBP		✓
<b>Optional Items Available in Both Models</b>		
Pacing		
SpO2		

## How to Use This Manual

The R Series Operator's Guide provides information operators need for the safe and effective use and care of the R Series products. It is important that all persons using this device read and understand all the information contained within.

Please read thoroughly the safety considerations and warnings section.

Procedures for daily checkout and unit care are located in “Maintenance” on page 13-1.

This manual is supplemented by manual inserts for options available on the R Series. These inserts contain additional warnings, precautions, and safety-related information.

## Operator’s Guide Updates

An issue or revision date for this manual is shown on the front cover. If more than three years have elapsed since this date, contact ZOLL Medical Corporation to determine if additional product information updates are available.

All users should carefully review each manual update to understand its significance and then file it in its appropriate section within this manual for subsequent reference.




Product documentation is available through the ZOLL website at [www.zoll.com](http://www.zoll.com). From the Products menu, choose Product Manuals.











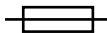



## Unpacking















Carefully inspect each container for damage. If the shipping container or cushion material is damaged, keep it until the contents have been checked for completeness and the instrument has been checked for mechanical and electrical integrity. If the contents are incomplete, if there is mechanical damage, or if the defibrillator does not pass its electrical self-test, U.S.A. customers should call ZOLL Medical Corporation (1-800-348-9011). Customers outside of the U.S.A. should contact the nearest ZOLL authorized representative. If the shipping container is damaged, also notify the carrier.






## Symbols Used on the Equipment

Any or all of the following symbols may be used in this manual or on this equipment:

Symbol	Description
	Dangerous voltage.
	MR unsafe: keep away from magnetic resonance imaging equipment
	Attention, consult accompanying documents.

Symbol	Description
	Fragile, handle with care.
	Keep dry.
	This end up.
	Temperature limitation.
	<b>Conformité Européenne</b> Complies with medical device directive 93/42/EEC.
	Type B patient connection.
	Type BF patient connection.
	Type CF patient connection.
	Defibrillator-proof type BF patient connection.
	Defibrillator-proof type CF patient connection.
	Fusible link.
	Equipotentiality.
	Alternating current (AC).
	Direct current (DC).

Symbol	Description
	<p>Contains lithium. Recycle or dispose of properly.</p>
	<p>Keep away from open flame and high heat.</p>
	<p>Do not open, disassemble, or intentionally damage.</p>
	<p>Do not crush.</p>
	<p>Do not discard in trash. Recycle or dispose of properly.</p>
	<p>Return to a collection site intended for waste electrical and electronic equipment (WEEE). Do not dispose of in unsorted trash.</p>
	<p>Date of manufacture.</p>
	<p>Use by.</p>
	<p>Latex-free.</p>
	<p>Do not reuse.</p>
	<p>Do not fold.</p>
	<p>Not sterile.</p>
	<p>Nonionizing electromagnetic radiation from Wi-Fi during data transfer.</p>
	<p>Manufacturer.</p>

Symbol	Description
	Authorized representative in the European Community.
	Serial Number.
	Catalogue number.
	Consult instructions for use.
<b>Rx ONLY</b>	Prescription only.
E <sub>MAX</sub> = 200J	Maximum energy.
	Test port.

## Conventions

This guide uses the following conventions:

Within text, the names and labels for physical buttons and softkeys appear in **boldface** type (for example, “Press the **SHOCK** button or the **Code Marker** softkey”).

This guide uses uppercase italics for audible prompts and for text messages displayed on the screen (for example, *CHECK PATIENT*).

---

**WARNING!** Warning statements alert you to conditions or actions that can result in personal injury or death.

---



---

**Caution** Caution statements alert you to conditions or actions that can result in damage to the unit.

---

## Defibrillator Function

The R Series product contains a direct current (DC) defibrillator capable of delivering up to 200 joules. It may be used in synchronized mode to perform synchronized cardioversion using the patient’s R-wave as a timing reference. The unit uses paddles or disposable, pregelled electrodes for defibrillation.

## Intended Use — Manual Operation

In manual mode, the unit can also be used for synchronized cardioversion of certain atrial or ventricular arrhythmias. A qualified physician must decide when synchronized cardioversion is appropriate.

The advisory function should be used to confirm ventricular fibrillation or wide complex ventricular tachycardia (greater than 150 beats per minute) in patients meeting the three conditions indicating lack of circulation (listed above).

## Intended Use — Semiautomatic Operation (AED)

The R Series Semiautomatic mode is specifically designed for use in early defibrillation programs where the delivery of a defibrillator shock during resuscitation involving CPR, in-hospital transportation, and definitive care are incorporated into a medically-approved patient care protocol.

Specifications for the ECG rhythm analysis function are provided in the section, “ECG Rhythm Analysis Algorithm Accuracy” on page A-29.

When the patient is less than 8 years of age or weighs less than 55 lbs. (25 Kg), you must use ZOLL pediatric defibrillation electrodes. Do not delay therapy to determine patient’s exact age or weight.

## Intended Use — ECG Monitoring

The unit is intended for use when ECG monitoring is indicated to evaluate the patient’s heart rate or ECG morphology. In ECG monitoring mode, the unit is intended to be used by personnel who are qualified by training in the use of the R Series defibrillator, basic life and/or advanced life support, or other physician-authorized emergency medical training.

## Intended Use — Real CPR Help

The Real CPR Help function provides visual and audio feedback designed to encourage rescuers to perform chest compressions at the AHA/ERC recommended rate of 100 - 120 compressions per minute. Voice and visual prompts encourage a compression depth in accordance with AHA and/or ERC recommendations of 2 inches (5 cm) minimum for adult patients.

## Defibrillator Complications

Inappropriate defibrillation or cardioversion of a patient (for example, with no malignant arrhythmia) may precipitate ventricular fibrillation, asystole, or other dangerous arrhythmias.

Defibrillation without proper application of electrodes or paddle electrolyte gel might be ineffective and cause burns, particularly when repeated shocks are necessary. Erythema or hyperemia of the skin under the paddles, or electrodes often occurs; this effect is usually enhanced along the perimeter of the paddles or electrodes. This reddening should diminish substantially within 72 hours.

## Defibrillator Output Energy

R Series defibrillators can deliver as much as 200 joules into a 50 ohm impedance. The energy delivered through the chest wall, however, is determined by the patient's transthoracic impedance. An adequate amount of electrolyte gel must be applied to the paddles and a force of 10 to 12 kilograms (22 to 26.4 pounds) must be applied to each paddle in order to minimize this impedance. If hands-free therapy electrodes are used, make sure that they are properly applied. (Refer to the instructions on the electrode package).

## External Pacemaker (Optional)

Some R Series products include an optional transcutaneous pacemaker consisting of a pulse generator and ECG-sensing circuitry. Noninvasive transcutaneous pacing (NTP) is an established and proven technique. This therapy is easily and rapidly applied in both emergency and nonemergency situations when temporary cardiac stimulation is indicated.

The output current of the pacemaker is continuously variable from 0 to 140 mA. The rate is continuously variable from 30 to 180 pulses per minute (ppm), by increments of 2.

The pacing output pulse is delivered to the heart via ZOLL hands-free defibrillation/pacing electrodes placed on the patient's back and the precordium.

The characteristics of the output pulse, together with the design and placement of the electrodes, minimize cutaneous nerve stimulation, cardiac stimulation threshold currents, and reduce discomfort due to skeletal muscle contraction.

The unique design of the R Series products allow clear viewing and interpretation of the electrocardiogram on the display without offset or distortion during external pacing.

Proper operation of the device, together with correct electrode placement, is critical to obtaining optimal results. Every operator must be thoroughly familiar with these operating instructions.

## Intended Use — Pacemaker

This product can be used for temporary external cardiac pacing in conscious or unconscious patients as an alternative to endocardial stimulation.

The purposes of pacing include:

- Resuscitation from standstill or bradycardia of any etiology.

Noninvasive pacing has been used for resuscitation from cardiac standstill, reflex vagal standstill, drug-induced standstill (due to procainamide, quinidine, digitalis, b-blockers, verapamil, etc.) and unexpected circulatory arrest (due to anesthesia, surgery, angiography, and other therapeutic or diagnostic procedures). It has also been used for temporary acceleration of bradycardia in Stokes-Adams disease and sick-sinus syndrome. It is safer, more reliable, and more rapidly applied in an emergency than endocardial or other temporary electrodes.

- As a standby when standstill or bradycardia might be expected.

Noninvasive pacing can be useful as a standby when cardiac arrest or symptomatic bradycardia might be expected due to acute myocardial infarction, drug toxicity, anesthesia, or surgery. It is also useful as a temporary treatment in patients awaiting pacemaker implants or the introduction of transvenous therapy. In standby pacing applications,

noninvasive pacing might provide an alternative to transvenous therapy that avoids the risks of displacement, infection, hemorrhage, embolization, perforation, phlebitis, and mechanical or electrical stimulation of ventricular tachycardia or fibrillation associated with endocardial pacing.

- Suppression of tachycardia.

Increased heart rates in response to external pacing often suppress ventricular ectopic activity and might prevent tachycardia.

---

**WARNING! This device can only be used for external pacing of patients and cannot be used for internal pacing. Do not connect internal pacing lead wires to the ZOLL defibrillator.**

---

## Pacemaker Complications

Ventricular fibrillation does not respond to pacing and requires immediate defibrillation. Therefore, the patient's dysrhythmia must be determined immediately, so that you can employ appropriate therapy. If the patient is in ventricular fibrillation and defibrillation is successful but cardiac standstill (asystole) ensues, you should use the pacemaker.

Ventricular or supraventricular tachycardias can be interrupted with pacing, but in an emergency or during circulatory collapse, synchronized cardioversion is faster and more certain.

Pulseless electrical activity (PEA) can occur following prolonged cardiac arrest or in other disease states with myocardial depression. Pacing might then produce ECG responses without effective mechanical contractions, making other effective treatment necessary.

Pacing can evoke undesirable repetitive responses, tachycardia, or fibrillation in the presence of generalized hypoxia, myocardial ischemia, cardiac drug toxicity, electrolyte imbalance, or other cardiac diseases.

Pacing by any method tends to inhibit intrinsic rhythmicity. Abrupt cessation of pacing, particularly at rapid rates, can cause ventricular standstill and should be avoided.

Noninvasive temporary pacing can cause discomfort of varying intensity, which occasionally can be severe and preclude its continued use in conscious patients.

Similarly, unavoidable skeletal muscle contraction might be troublesome in very sick patients and might limit continuous use to a few hours. Erythema or hyperemia of the skin under the hands-free therapy electrodes often occurs; this effect is usually enhanced along the perimeter of the electrode. This reddening should lessen substantially within 72 hours.

There have been reports of burns under the anterior electrode when pacing adult patients with severely restricted blood flow to the skin. Prolonged pacing should be avoided in these cases and periodic inspection of the underlying skin is advised.

There are reports of transient inhibition of spontaneous respiration in unconscious patients with previously available units when the anterior electrode was placed too low on the abdomen.

---

**WARNING! This device can only be used for external pacing of patients and cannot be used for internal pacing. Do not connect internal pacing lead wires to the ZOLL defibrillator.**

---



## Pediatric Pacing

Pacing can be performed on pediatric patients weighing 55 lb. (25 kg) or less using ZOLL pediatric hands-free therapy electrodes. Prolonged pacing (in excess of 30 minutes), particularly in neonates, can cause burns. Periodic inspection of the underlying skin is recommended.

## Intended Use — SpO<sub>2</sub> Monitoring

The R Series pulse oximeter, with the Masimo<sup>®</sup> SET<sup>®</sup> technology and the LNCS<sup>®</sup> series of oximeter sensors, is indicated for the continuous, noninvasive monitoring of arterial oxygen saturation (SpO<sub>2</sub>) and pulse rate during both no motion and patient motion conditions for adult patients, and no motion conditions for pediatric and neonatal patients in a hospital environment.

### SpO<sub>2</sub> Contraindications for Use

See the *R Series Pulse Oximetry (SpO<sub>2</sub>)* insert (ZOLL part number 9650-0901-01) for disclosures of any contraindications for use of the pulse oximeter monitoring feature.

## Intended Use — EtCO<sub>2</sub> Monitoring

The ZOLL R Series EtCO<sub>2</sub> option with Respironics Novamatrix technology is indicated for the continuous noninvasive monitoring of end tidal carbon dioxide (EtCO<sub>2</sub>) and respiration rate in patients requiring ventilator support, in-hospital transport, or anesthesia. The R Series EtCO<sub>2</sub> option with Respironics Novamatrix technology supports two methods for continuous measurement of end tidal carbon dioxide (EtCO<sub>2</sub>) and respiration rate.

The first method uses the CAPNOSTAT 5 Mainstream CO<sub>2</sub> sensor attached to an airway adapter that connects to an endotracheal tube, mask or disposable mouthpiece.

The second method uses the LoFlo CO<sub>2</sub> module to monitor both non-intubated and intubated patients using specially designed sampling cannulas and airway adapters.

The R Series EtCO<sub>2</sub> option is designed to monitor adult, pediatric, and neonatal patients.

The following substances can influence CO<sub>2</sub> measurements made with the CAPNOSTAT 5 mainstream CO<sub>2</sub> sensor or the LoFlo sidestream module:

- elevated oxygen levels
- nitrous oxide
- halogenated agents

The R Series EtCO<sub>2</sub> option provides settings for high oxygen and/or nitrous oxide compensation. Halogenated anesthetic agents alter CO<sub>2</sub> readings, but the R Series unit will monitor CO<sub>2</sub> within specifications when these agents are present at normal clinical levels. The presence of Desflurane in the exhaled breath beyond normal values (5%) may positively bias measured carbon dioxide values by up to an additional 3 mmHg.

The R Series EtCO<sub>2</sub> option is intended for use only with the ZOLL/Respironics Novamatrix CAPNOSTAT 5 Mainstream CO<sub>2</sub> Sensor and mainstream airway adapters, the LoFlo CO<sub>2</sub> Module, nasal and nasal/oral sampling cannula sets, and sidestream on-airway adapters.

The R Series EtCO<sub>2</sub> option can be used on adult patients (21 years of age and older) and on pediatric patients, as described in the following table:

Pediatric Subpopulation	Approximate Age Range
Newborn (neonate)	Birth to 1 month of age
Infant	1 month to 2 years of age
Child	2 to 12 years of age
Adolescent	12-21 years of age

### EtCO<sub>2</sub> Contraindications for Use

See the *R Series End Tidal Carbon Dioxide (EtCO<sub>2</sub>)* insert (ZOLL part number 9650-0915-01) for disclosures of any contraindications for use of the EtCO<sub>2</sub> monitoring feature.

## Intended Use — NIBP

The ZOLL R Series NIBP option is indicated for the non-invasive measurement of arterial blood pressure for resting patients in critical care and in-hospital transport.

The R Series NIBP option is designed to measure blood pressure for adult patients (21 years of age and older) and for pediatric patients, as described in the following table:

Pediatric Subpopulation	Approximate Age Range
Newborn (neonate)	Birth to 1 month of age
Infant	1 month to 2 years of age
Child	2 to 12 years of age
Adolescent	12-21 years of age

### NIBP Contraindications for Use

See the *R Series Non-Invasive Blood Pressure (NIBP)* insert (ZOLL part number 9650-0914-01) for disclosures of any contraindications for use of the NIBP monitoring feature.

## ECG Monitoring

The patient's ECG is monitored by connecting the patient to the unit via a 3- or 5-lead patient cable, hands-free therapy electrodes, or through paddles. Five seconds of ECG is presented on the display along with the following information:

- averaged heart rate, derived by measuring R to R intervals
- lead selection - I, II, III, aVR, aVL, aVF, V (with ECG cable), PADDLES or PADS, P1, P2, P3 (when using OneStep Pacing cable with OneStep Complete electrodes).

P1, P2, and P3 are non-standard ECG leads derived from electrodes within particular OneStep electrodes. While ECG signals acquired from these leads are appropriate for rhythm assessment and determining electrical capture during pacing, they should not be

used for ECG morphological evaluation. Attach conventional ECG electrodes for diagnostic purposes.

- ECG size relative scale factor - x0.5, x1, x1.5, x2, x3
- other operational prompts, messages, and diagnostic codes

Monitoring or diagnostic ECG bandwidth is selectable.

## Recorder Function (Manual Mode Only)

The strip recorder is provided to document events in Manual mode. The strip recorder normally operates in the delay mode (6 seconds) to ensure the capture of ECG information immediately preceding critical events. The recorder may be activated manually by pressing the **RECORDER** button. It is activated automatically whenever a defibrillation **SHOCK** is delivered, a heart rate alarm occurs, or the rhythm analysis function is activated. The strip recorder may also be configured not to print during these events.

## Paddles and Electrodes

In AED mode, the R Series will defibrillate, cardiovert, and monitor ECG using only hands-free therapy electrodes. In Manual mode, the R Series will defibrillate, cardiovert, and monitor ECG using either defibrillation paddles or hands-free therapy electrodes.

The pacer version of the R Series will pace using ZOLL hands-free therapy electrodes.

**ENERGY SELECT**, **CHARGE** and **SHOCK** controls are located on the paddles and front panel. When using hands-free therapy electrodes, you must use the controls on the front panel of the unit. To switch between paddles and hands-free therapy electrodes, remove the OneStep cable from the apex paddle and connect the hands-free therapy electrodes to the cable.

The Advisory function cannot be activated unless hands-free therapy electrodes are attached to the OneStep cable and used as the ECG monitoring lead.

The R Series can monitor the patient's ECG while pacing without the need for a separate ECG cable and ECG electrodes. This also allows demand pacing when separate ECG electrodes are either not connected, or unavailable. OneStep pacing capability requires the OneStep Pacing cable along with OneStep Pacing electrodes, or OneStep Complete electrodes.

**Note:** The ZOLL OneStep electrodes, MFE Pads, Pediatric MFE Pads, Stat-padz<sup>®</sup>, and ECG electrodes are disposable, single-use items.

You should always check the expiration date on the electrode packaging. Do not use expired electrodes, which might result in false patient impedance readings and affect the level of delivered energy, or cause burns.



This symbol on the electrode package is accompanied by the expiration date.

The R Series defibrillator reads and reports the expiration date for all OneStep electrodes (except for OneStep Basic). When these electrodes exceed their expiration date, the Code Readiness indicator will change to a red “X.”

**Note:** ZOLL electrodes contain no hazardous materials and may be disposed of in general trash unless contaminated with pathogens. Use appropriate precautions when disposing of contaminated electrodes.

When the patient is less than 8 years old or weighs less than 55 lb. (25 kg), use ZOLL pediatric defibrillation electrodes. Do not delay therapy to determine the patient’s exact age or weight.

## Batteries

R Series products use an easily replaced rechargeable lithium-ion battery pack (the ZOLL *SurePower* battery pack). A new, fully charged battery pack typically delivers more than 5 hours of ECG monitoring. Use of other functions (such as the defibrillator, printer, or pacemaker) reduces this time.

When a *LOW BATTERY* message appears on the display and the unit emits two beeps in conjunction with the displayed message, the battery must be replaced and recharged.

You can charge the battery by either of the following methods:

- **Internal charging** — plug the R Series into an AC power supply to automatically begin charging the installed battery pack. The front panel battery indicator operates as follows:

When the indicator is:	It means:
Steady yellow	Battery is charging
Steady green	Battery is charged
Alternating yellow and green	No battery is installed or a battery charging fault has been detected.
Not lit	The defibrillator is not connected to AC mains.

**Note:** Upon power up, it takes approximately 45 seconds for the LEDs on the battery to accurately display run time.

- **External charging** — use the ZOLL SurePower Battery Charger to charge the battery pack and test the battery’s capacity. For details, refer to the *ZOLL SurePower defibrillator battery Operator’s Manual*.

## Code-Ready System

The R Series defibrillator’s Code-Ready system tests the defibrillator whenever the unit is turned on, periodically during operation, whenever manual testing is initiated by the operator, and automatically, at pre-configured intervals.

The code readiness indicator on the front panel shows the result of the most recent readiness check. Also, OneStep Pacing, CPR or Complete electrodes provide an interface that communicates the electrode’s expiration date and condition to the defibrillator.

The Defib Test Log stores the results for as many as 1000 defibrillator tests in internal memory. Each log entry shows the time and date of the defibrillator test. The Defib Test Log can be printed on the stripchart or transferred to a personal computer for printing and archiving.

## Safety Considerations



All operators should review these safety considerations before using the R Series.

R Series products are high-energy defibrillators capable of delivering 200 joules. To completely deactivate the unit, turn the Mode Selector to **OFF**.

To manually disarm a charged (or charging) defibrillator, do one of the following:

- In AED mode, Turn the Mode Selector to **OFF**.
- In Manual mode, turn the Mode Selector to **OFF** or **PACER**, or change the selected defibrillator energy.

For safety, in Manual mode, the R Series unit automatically disarms if left charged for more than either 60 or 120 seconds (user configurable) if the **SHOCK** button is not pressed; in AED mode, the R Series unit automatically disarms if left charged for more than 30 seconds.

## Warnings

### General

Federal (U.S.A.) law restricts this defibrillator to use by or on the order of a physician.

Only appropriately trained, skilled personnel who are familiar with equipment operation should perform emergency defibrillation. The prescribing physician should determine what training, such as Advanced Cardiac Life Support (ACLS) or Basic Life Support (BLS) certification, is appropriate.

Only skilled personnel trained in Advanced Cardiac Life Support (ACLS) and who are familiar with equipment operation should perform synchronized cardioversion. The precise cardiac arrhythmia must be determined before attempting defibrillation.

These operating instructions describe the functions and proper operation of the R Series products. They are not a substitute for a formal patient care training course. Operators should obtain formal training from an appropriate authority before using this defibrillator for patient care.

Proper operation of the unit and correct electrode placement is critical to obtaining optimal results. Operators must be thoroughly familiar with proper device operation.

The use of external pacing/defibrillation electrodes or adapter devices from sources other than ZOLL is not recommended. ZOLL makes no representations or warranties regarding the performance or effectiveness of its products when used with pacing/defibrillation electrodes or adapter devices from other sources. Defibrillator failures attributable to the use of pacing/defibrillation electrodes or adapters not manufactured by ZOLL might void ZOLL's warranty.

Do not disassemble the unit. A shock hazard exists. Refer all problems to authorized service personnel.

Follow all recommended maintenance instructions. If a problem occurs, obtain service immediately. Do not use the defibrillator until it has been inspected by appropriate personnel.

The R Series unit might not perform to specifications when stored at the upper or lower extreme limits of storage temperature and then immediately put into use.

Avoid using the R Series adjacent to, or stacked on, other equipment. If unavoidable, verify that the R Series operates normally in this configuration before clinical use.

The R Series should be installed and put into service according to the EMC information in Appendix A of this manual.

Assess the Wi-Fi performance for the possibility of RFI in your environment of use.

If multiple devices are transmitting simultaneously to the same access point, Wi-Fi data transfer will be slowed down. If the access point is too overloaded, data transmission failures can occur.

The use of accessories, transducers, and cables other than those specified in this manual and related R Series option manual inserts may result in increased emissions or decreased immunity of the R Series.

Do not use or place the unit in service if the Code Readiness indicator (at the upper right of the front panel) displays a red "X".

Carefully route patient cables to avoid tripping over them, or inadvertently pulling the unit onto the patient.

Always inspect the unit for damage if it has been dropped.

To avoid risk of electric shock, this equipment must only be connected to a supply mains with protective earth.

Do not modify this equipment without authorization from the manufacturer.

Ensure that the unit is always positioned so as to allow unobstructed access to and detachment of the power cord from the unit to AC mains.

MR Unsafe: Keep the R Series defibrillator away from magnetic resonance imaging (MRI) equipment.

### **ECG Analysis, Defibrillating, Pacing and CPR**

Prior to attempting synchronized cardioversion, ensure the ECG signal quality is good and that sync markers are displayed above each QRS complex.

Do not use the unit in AED mode or advisory mode during patient movement. A patient must be motionless during ECG rhythm analysis. Do not touch the patient during analysis. If transporting the patient in the hospital, cease all movement before beginning ECG analysis.

ECG rhythm analysis does not warn of patient asystole, which is not a shockable rhythm.

The ECG rhythm analysis function might not reliably identify ventricular fibrillation in the presence of an implanted pacemaker. Inspection of the electrocardiogram and clinical evidence of cardiopulmonary arrest should be the basis for any treatment of patients with an implanted pacemaker.

Implanted pacemakers might cause the heart rate meter to count the pacemaker rate during incidents of cardiac arrest or other arrhythmias. Dedicated pacemaker detection circuitry may not detect all implanted pacemaker spikes. Check the patient's pulse; do not rely solely on heart rate meters. Patient history and physical examination are important factors in determining the presence of an implanted pacemaker. Pacemaker patients should be carefully observed.

Do not place electrodes directly over an implanted pacemaker.

The R Series unit detects ECG electrical signals only. It does not detect a pulse (effective circulatory perfusion). Always verify pulse and heart rate by physical assessment of the patient. Never assume that the display of a nonzero heart rate means that the patient has a pulse.

To avoid possible damage to the R Series unit, turn off pacing before defibrillating the patient with a second defibrillator.

Do not use the unit's ECG-out signal as a synchronization pulse for another defibrillator or cardioverter.

Place the patient on a firm surface before performing CPR.

### Battery

Do not operate the unit without a battery. Always have a source of available backup power for all anticipated use environments. A fully charged spare battery or ready access to AC mains power from a local wall outlet can provide this backup power.

Test battery packs regularly. A battery that does not pass the ZOLL charger's capacity test might cause the R Series unit to shut down unexpectedly.

When the warning *LOW BATTERY* appears, plug the R Series unit into a power source or install a fully charged battery pack. When the warning *REPLACE BATTERY* appears, immediately replace the battery pack with a fully charged pack or plug the R Series unit into a power source, as unit shut down due to a low battery condition is imminent.

If mistreated, a battery pack might explode. Do not disassemble a battery pack or dispose of it in fire.

## Operator Safety



Do not use R Series products in the presence of oxygen-rich atmospheres, flammable anesthetics, or other flammable agents (such as gasoline). Using the unit in such environments might cause an explosion.

Do not use the unit near or within standing water. Electrical safety might be compromised when the defibrillator is wet.

Never discharge the unit with the defibrillation electrodes or paddles shorted together or in open air.

Do not discharge the defibrillator except as indicated in the instructions. Discharge the defibrillator only when defibrillation electrodes or paddles are properly applied to the patient.

To avoid risk of electrical shock, do not touch the gelled area of the hands-free therapy electrodes during pacing or defibrillation.

To avoid risk of electrical shock, do not allow electrolyte gel to accumulate on hands or paddle handles.

To avoid risk of electrical shock, do not allow patient connectors to contact other conductive parts, including earth.

For defibrillation using paddles, use only high-conductivity electrolyte gel specified for such use by the manufacturer.

When using paddles for defibrillation, use your thumbs to operate the **SHOCK** buttons. Doing so avoids inadvertent shock to the operator and unintentional depression of an **ENERGY SELECT** button, which causes the defibrillator to disarm. Keep your hands and fingers away from the paddle plates.

The use of accessory equipment that does not comply with the equivalent safety requirements of the R Series defibrillator could reduce the level of safety of the combined system. When choosing accessory equipment, consider the following:

- Use of the accessory in the patient vicinity.
- Evidence that the safety certification of the accessory has been performed in accordance with the appropriate IEC (EN) 60601-1 and/or IEC (EN) 60601-1-1 harmonized national standards.

Always check that the equipment functions properly and is in proper condition before use.

Disconnect all electro-medical equipment that is not defibrillation-protected from the patient prior to defibrillation.

Before discharging the defibrillator, warn everyone to **STAND CLEAR** of the patient.

Do not touch the bed, patient, or any equipment connected to the patient during defibrillation. A severe shock can result. To avoid hazardous pathways for the defibrillation current, do not allow exposed portions of the patient's body to touch any metal objects, such as a bed frame.

When the R Series is performing a Code Readiness test, as indicated on the display, do not touch the connected paddles, electrodes, or OneStep cable connector.

## Patient Safety



This equipment should be connected to only one patient at a time.

Use only OneStep Pediatric electrodes to defibrillate patients under 8 years of age in AED or advisory modes. Use of adult electrodes, or pediatric electrodes other than OneStep Pediatric electrodes, can result in the delivery of excessive energy doses.

Neonatal and pediatric defibrillation energy level settings should be based on site-specific clinical protocols.

To ensure patient safety, connect the R Series only to equipment with galvanically isolated circuits.

Use only high-quality ECG electrodes. ECG electrodes are for rhythm acquisition only; you cannot use ECG electrodes for defibrillation or pacing.

Do not use therapy or ECG electrodes if the gel is dried, separated, torn or split from the foil; patient burns may result from using such electrodes. Poor adherence and/or air pockets under therapy electrodes can cause arcing and skin burns.

Check the expiration date on the electrode packaging. Do not use electrodes after their expiration date.

Excessive body hair or wet, diaphoretic skin can inhibit electrode coupling to the skin. Clip excess hair and dry any moisture from the area where an electrode is to be attached.

Therapy electrodes should be replaced periodically during continuous pacing. Consult electrode directions for proper replacement instructions.



---

Prolonged pacing (more than 30 minutes), particularly in neonates or adults with severely restricted blood flow, may cause burns. Periodically inspect the skin under the electrodes.

Carefully route the patient cables to reduce the possibility of patient entanglement or strangulation.

To avoid electrosurgery burns at monitoring sites, ensure proper connection of the electrosurgery return circuit so that a return path cannot be made through monitoring electrodes or probes.

During electrosurgery, observe the following guidelines to minimize electrosurgery unit (ESU) interference and provide maximum operator and patient safety:

- Keep all patient monitoring cables away from earth ground, ESU knives, and ESU return wires.
- Use electrosurgical grounding pads with the largest practical contact area.

Always ensure proper application of the electrosurgical return electrode to the patient.

Check electrical leakage levels before use. Leakage current might be excessive if more than one monitor or other piece of equipment is connected to the patient.

Do not use the ZOLL OneStep Pacing cable (**REF** 1009-0913-02) or the ZOLL Multi-Function Cable (**REF** 1009-0913-03) in a 220/240 VAC 60Hz power environment. Patient leakage current may be excessive.

Do not place the unit in contact with a patient. Burns may result.

## Cautions

If the unit is to be stored longer than 90 days, remove the battery pack.

Do not sterilize the defibrillator, or its accessories unless the accessories are labelled as sterilizable.

Do not immerse any part of the defibrillator in water.

Do not use ketones (such as acetone or MEK) on the defibrillator.

Avoid using abrasives (including paper towels) on the display window.

To protect the unit from damage during defibrillation, for accurate ECG information, and to protect against noise and other interference, use only internal current-limiting ECG cables specified or supplied by ZOLL.

For continued safety and EMI performance, use only the line cord supplied by ZOLL.

Dispose of battery packs in accordance with national, regional and local regulations. Battery packs should be shipped to a reclamation facility for recovery of metal and plastic compounds as the proper method of waste management.

## Restarting the Defibrillator

Certain events require the R Series products to be restarted after they shut off or become inoperative (for example, when the battery runs down and the unit shuts off).

In such a case, always try to restore defibrillator operation as follows:

1. Turn the Mode Selector to **OFF**.

2. If necessary, replace a depleted battery with a fully charged pack, or connect the defibrillator to AC mains.
3. Turn the Mode Selector to the desired operating mode to restart the unit.

This sequence is necessary to restart the defibrillator and can also be used to clear some fault messages when immediate use of the defibrillator is required.

If restarted after a shutdown period of 10 seconds or more, the unit restores all settings (such as ECG lead, ECG size, and alarm state and limits) to their power-up default values. After restoring device operation, you might need to reinstate previously selected, non-default settings.

## FDA Tracking Requirements

U.S. Federal Law (21 CFR 821) requires the tracking of defibrillators. Under this law, owners of this defibrillator must notify ZOLL Medical Corporation if this product is

- received
- lost, stolen, or destroyed
- donated, resold, or otherwise distributed to a different organization

If any such event occurs, contact ZOLL Medical Corporation in writing with the following information:

1. Originator's organization – Company name, address, contact name, and contact phone number
2. Model number, and serial number of the defibrillator
3. Disposition of the defibrillator (for example, received, lost, stolen, destroyed, distributed to another organization), new location and/or organization (if known and different from originator's organization) – company name, address, contact name, and contact phone number
4. Date when the change took effect

Please address the information to:

**ZOLL Medical Corporation**  
**Attn: Tracking Coordinator**  
**269 Mill Road**  
**Chelmsford, MA 01824-4105**

Fax: (978) 421-0025  
Telephone: (978) 421-9655

## Notification of Adverse Events

As a health care provider, you may have responsibilities under the Safe Medical Devices Act (SMDA), for reporting to ZOLL Medical Corporation, and possibly to the FDA, the occurrence of certain events.

These events, described in 21 CFR Part 803, include device-related death and serious injury or illness. In addition, as part of our Quality Assurance Program, ZOLL Medical Corporation

requests to be notified of device failures or malfunctions. This information is required to ensure that ZOLL Medical Corporation provides only the highest quality products.

## Software License

**Note:** Read this Operator's Guide and License agreement carefully before operating any of the R Series products.

Software incorporated into the system is protected by copyright laws and international copyright treaties as well as other intellectual property laws and treaties. This software is licensed, not sold. By taking delivery of and using this system, the Purchaser signifies agreement to and acceptance of the following terms and conditions:

1. **Grant of License:** In consideration of payment of the software license fee which is part of the price paid for this product ZOLL Medical Corporation grants the Purchaser a non-exclusive license, without right to sublicense, to use the system software in object-code form only.
2. **Ownership of Software/Firmware:** Title to, ownership of and all rights and interests in the system software and all copies thereof remain at all times vested in the manufacturer, and Licensors to ZOLL Medical Corporation and they do not pass to purchaser.
3. **Assignment:** Purchaser agrees not to assign, sublicense or otherwise transfer or share its rights under the license without the express written permission of ZOLL Medical Corporation.
4. **Use Restrictions:** As the Purchaser, you may physically transfer the products from one location to another provided that the software/firmware is not copied. You may not disclose, publish, translate, release or distribute copies of the software/firmware to others. You may not modify, adapt, translate, reverse engineer, decompile, crosscompile, disassemble or create derivative works based on the software/firmware.

### NO IMPLIED LICENSE

Possession or purchase of this device does not convey any express or implied license to use the device with replacement parts which would, alone, or in combination with this device, fall within the scope of one or more of the patents relating to this device.

## Service

The R Series does not require periodic recalibration or adjustment. Appropriately trained and qualified personnel should, however, perform periodic tests of the defibrillator to verify proper operation.

If a unit requires service, contact the ZOLL Technical Service Department.

For customers In the U.S.A.	For customers outside the U.S.A.
Telephone: 1-800-348-9011 1-978-421-9655  Fax: 1-978-421-0010	Call the nearest authorized ZOLL Medical Corporation representative.  To locate an authorized service center, contact the International Sales Department at  ZOLL Medical Corporation 269 Mill Road Chelmsford, MA 01824-4105  Telephone: 1-978-421-9655

When requesting service, please provide the following information to the service representative:

- Unit serial number
- Description of the problem
- Department using the equipment and name of the person to contact
- Purchase order to allow tracking of loan equipment
- Purchase order for a unit with an expired warranty
- Sample ECG or other stripcharts demonstrating the problem (if available and applicable), less any confidential patient information.

**Returning a unit for service**

Before sending a unit to the ZOLL Technical Service Department for repair, obtain a service request (SR) number from the service representative.

Remove the battery pack from the unit. Pack the unit with its cables and battery in the original containers (if available) or equivalent packaging. Be sure the assigned service request number appears on each package.

For customers	Return the unit to
In the U.S.A.	ZOLL Medical Corporation 269 Mill Road Chelmsford, MA 01824-4105  Attention: Technical Service Department ( <i>SR number</i> )  Telephone: 1-800-348-9011

For customers	Return the unit to
In Canada	ZOLL Medical Canada Inc. 1750 Sismet Road, Unit #1 Mississauga, ON L4W 1R6  Attention: Technical Service Department ( <i>SR number</i> )  Telephone: 1-866-442-1011
In other locations	The nearest authorized ZOLL Medical Corporation representative.  To locate an authorized service center, contact the International Sales Department at  ZOLL Medical Corporation 269 Mill Road Chelmsford, MA 01824-4105  Telephone: 1-978-421-9655

## The ZOLL Serial Number

Each ZOLL product displays a serial number that contains information about that product. From left to right, ZOLL serial numbers are structured as follows:

- A two-character product code
- A three-character date-of-manufacture code
- A product serial number of six or more alphanumeric characters

The product code for the R Series defibrillator is AF.

The first two characters of the date-of-manufacture code give the last two digits of the year (for example, “06” appears for products manufactured in 2006). The last character of the date-of-manufacture code gives the month in which the product was manufactured. The month appears in the form of a single alphanumeric character: “A” for January, “B” for February, “C” for March, and so on through “L” for December.

The product serial number is a unique set of alphanumeric characters that ZOLL assigns to each individual unit.

---

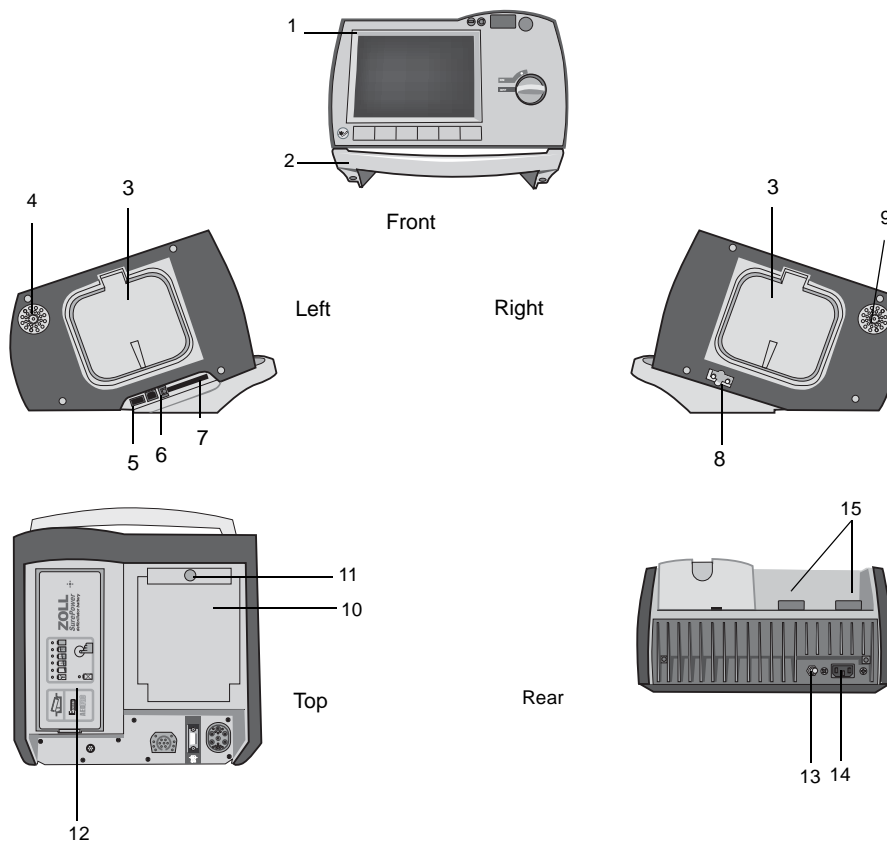
(This page intentionally left blank.)

---

# Chapter 2

## Product Overview

### Defibrillator Controls and Indicators



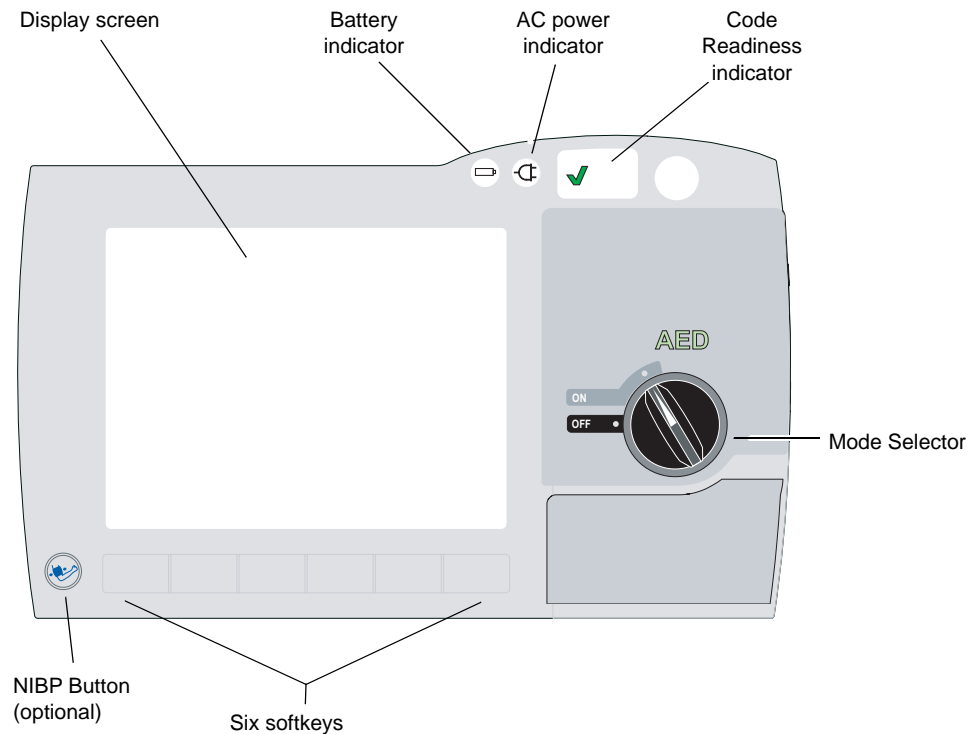
**Table 2-1. R Series Unit Features**

	<b>Item</b>	<b>Description</b>
1	Front panel	Includes the display screen and primary controls.
2	Handle	Integrated carrying handle.
3	External paddle well	Holds paddles when not in use. Allows defib self-test when paddles are stowed in their respective wells.
4	Beeper	Emits R-wave detection beeps, defib charge Ready tones, and alarm tones.
5	USB host connector (Optional)	(Reserved for future use — do not connect to any equipment.)
6	USB device connector	For connecting the R Series defibrillator to a USB device. For details, refer to “Event Records and Reports” on page 11-1.
7	Data card slot	Holds a compact flash card for copying data stored in the device’s internal memory. Accepts a CF memory card or a Wi-Fi card.
8	Defibrillator test port	When not using OneStep electrodes or paddles, connect the patient end of a OneStep cable to this port to allow device checks.
9	Speaker	Issues voice prompts.
10	Paper Compartment	Holds the paper for the stripchart printer.
11	RELEASE button	Allows access to the paper compartment.
12	Battery compartment	Holds a rechargeable lithium ion battery pack.
13	Grounding post	Earth-grounded terminal provided for the convenient connection of biomedical test equipment requiring an equipotential ground. This terminal has no clinical function and should not be used for electrical safety purposes.
14	AC mains connector	For connecting the device to an AC power source.
15	Patient connectors	For details, refer to “Patient Cables and Connectors” on page 2-8.



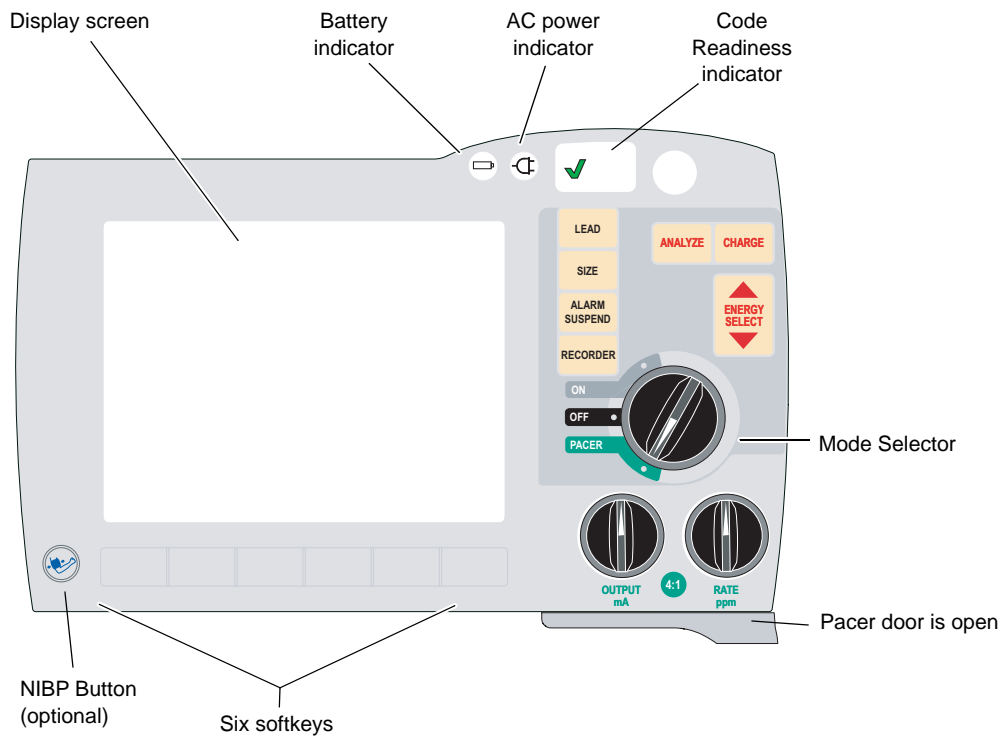
## The Front Panel

The front panel of the R Series device includes the display screen, softkeys, battery indicator, AC power indicator, Code Readiness indicator, **SHOCK** button, and control panel. The control panel configuration varies slightly depending on the model and whether the unit is in AED mode or Manual mode. See Figure 2-1 and Figure 2-2.



**Figure 2-1. R Series Front Panel (AED Mode)**

Table 2-2 describes the controls and indicators that appear on the front panel.





**Figure 2-2. R Series Front Panel (Manual Mode)**

**Table 2-2. R Series Controls and Indicators**

Control or Indicator	Description
Display screen	Shows therapeutic settings, physiological waveforms, and other information for each monitored parameter, messages, time, and softkey labels.
Battery indicator	Indicates battery status: Steady yellow: Battery is charging. Steady green: Battery is charged. Alternating yellow and green: No battery is installed, or there is a battery charging fault.
Indicator for AC power	Illuminated when the unit is plugged into an alternating current (AC) power source.
Code Readiness indicator	Shows the status of the unit, based on its most recent Readiness check: <ul style="list-style-type: none"> <li>• A green “✓” indicates the unit is ready for therapeutic use.</li> <li>• A red “X” indicates the unit’s Readiness is compromised and that it may not be ready for therapeutic use.</li> </ul>
Mode Selector	Selects the mode of operation (available options depend on model): <ul style="list-style-type: none"> <li>• OFF — Unit is powered off.</li> <li>• ON — Unit is automatically powered on in AED mode.</li> <li>• PACER — Unit is in pacer mode (pacer door drops open).</li> </ul>
ENERGY SELECT Buttons	Display in Manual mode only. Two sets of up-down arrow buttons control the selection of defibrillator energy, one set located on the front panel and the other located on the sternum paddle.

Table 2-2. R Series Controls and Indicators (continued)

Control or Indicator	Description
CHARGE Button	Displays in Manual mode only. Charges the defibrillator to the selected energy. In addition to the <b>CHARGE</b> button on the front panel, there is one located on the apex paddle handle.
SHOCK Button	The front panel <b>SHOCK</b> button is only active when using OneStep electrodes, hands-free therapy electrodes (see "R Series Accessories" on page B-1 for a list), external autoclavable paddles, or internal defibrillation paddles without a discharge button. The <b>SHOCK</b> button illuminates when the device is charged and ready.  To discharge the defibrillator when using paddles (internal or external) with discharge buttons, press and hold the <b>SHOCK</b> buttons on the paddles.
ANALYZE Button	Displays in Manual mode only. Initiates ECG analysis to determine whether or not a shockable rhythm is present.
LEAD Button	Displays in Manual mode only. Selects the ECG source for display and printing. Pressing this button sequentially selects ECG signals derived from each of the following lead configurations: I, II, III, aVR, aVL, aVF, PADDLES, or PADS, P1, P2, and P3 (when using OneStep Pacing electrodes, or OneStep Complete electrodes with OneStep Pacing cable) for display. The PADS or PADDLES lead setting is automatically selected when the defibrillator is turned to Manual mode with either hands-free therapy electrodes or paddles attached to the OneStep cable. Lead II or P3 (OneStep Pacing) is automatically selected when the R Series is powered up in PACER mode. Pads or Paddles monitoring is not available in PACER mode.
SIZE Button	Displays in Manual mode only. Selects the relative amplitude scale factor for the displayed ECG waveform. Available scale factors are x0.5, x1, x1.5, x2 and x3
ALARM SUSPEND Button	Displays in Manual mode only. Activates, deactivates or audibly suspends all alarm functions. A bell symbol (  ) appears on the display when alarms are enabled. When alarms are either audibly or permanently disabled, an "X" appears across the bell (  ) symbol.
RECORDER Button	Displays in Manual mode only. Starts or stops the stripchart recorder. When the ECG lead is selected, you can switch the unit to diagnostic ECG bandwidth (0.05 - 150Hz) by pressing and holding the <b>RECORDER</b> button. Diagnostic bandwidth is maintained as long as the <b>RECORDER</b> button is held down. When the <b>RECORDER</b> button is released, the unit reverts to standard monitoring bandwidth.
PACER OUTPUT mA (optional)	When pacing is selected, this control sets the amount of current delivered. The selected current setting is indicated on the display.
PACER RATE ppm (optional)	When pacing is selected, this control sets the rate (pulses per minute) at which the pacemaker will operate. The selected pace rate setting is indicated on the display.
4:1 Button (optional)	This button is used to determine a patient's underlying ECG rhythm. While depressed, this button causes pacing stimuli to be delivered at $\frac{1}{4}$ of the indicated ppm setting. When the button is released, normal pacing resumes.

**Table 2-2. R Series Controls and Indicators (continued)**

Control or Indicator	Description
NIBP Button (optional)	Allows you to start single, auto, or STAT non-invasive blood pressure measurements as described in the option insert <i>Non-Invasive Blood Pressure</i> (part number 9650-0914-01). Your unit has this button only if you ordered this configuration.
Softkeys	Six unlabeled buttons located directly below the display control different functions depending on the operating mode of the unit.  Labels for the softkeys appear at the bottom of the display directly above each softkey to indicate its function.
Charge Indicator Light (not shown)	Located on the apex paddle, this light turns on when the defibrillator is charged and ready.

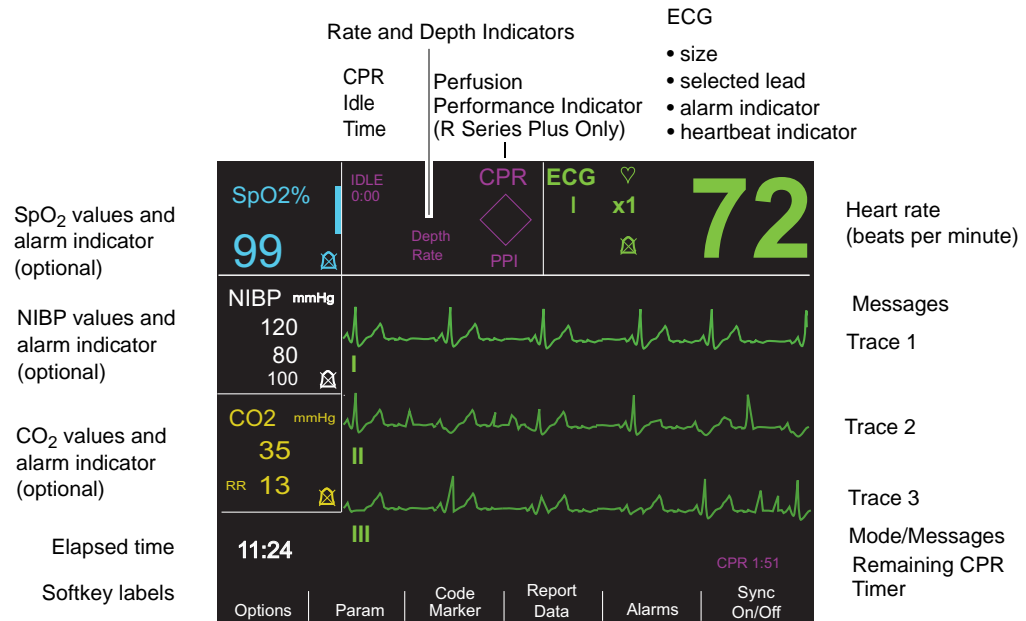
## Display Screen

**Note:** The screen content depends on the operational mode and the options installed.

The front panel includes a color display which shows:

- The elapsed time (since the unit was turned on).
- The ECG trace, selected lead, size, heartbeat indicator, and alarm status.
- The selected energy, charging status, and delivered energy for defibrillation and synchronized cardioversion.
- The output current and stimulus rate for pacing.
- The measured SpO<sub>2</sub> percent saturation, signal strength, plethysmographic trace (if applicable), and alarm status indicators for SpO<sub>2</sub> monitoring (optional).
- Non-invasive blood pressure (NIBP) readings: diastolic, systolic, and mean, plus alarm status indicators (optional; refer to the option insert *Non-Invasive Blood Pressure (NIBP)*, part number 9650-0914-01).
- The patient's carbon dioxide level, respiration rate and capnogram (if applicable), and alarm status indicators for CO<sub>2</sub> monitoring (optional; refer to the option insert *End Tidal Carbon Dioxide (EtCO<sub>2</sub>)*, part number 9650-0915-01).
- Messages and prompts.
- Labels above the softkeys (appropriate to the context).
- Perfusion Performance Indicator and Release Bar (R Series Plus Only).
- CPR Rate and Depth.
- Remaining CPR Timer.

Figure 2-3 shows the layout of parameter values, waveforms, system data, and softkey labels.



**Figure 2-3. R Series Display Screen (shown in manual mode with optional SpO<sub>2</sub>, NIBP and CO<sub>2</sub> monitoring)**

**Color coding**

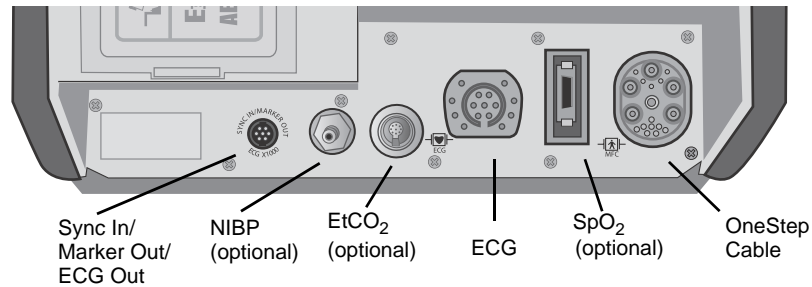
To differentiate information for various parameters, the unit displays each type of information in a specific user-configurable color.

**Messages**

During operation, a fault or error message is displayed when a fault is detected. If this occurs, turn the unit off and then on and recheck operation. If the fault persists, contact your authorized ZOLL agent as described on page 1-22.

## Patient Cables and Connectors

The back of the unit includes a set of connectors for patient cables.



**Figure 2-4. Patient Cable Connectors**

Connector	Description
OneStep Cable	For connecting paddles or ZOLL hands-free therapy and pacing electrodes using either OneStep or OneStep Pacing cables.
ECG	For connecting 3- or 5-lead ECG cable or OneStep Pacing cable's ECG cable.
Sync In / Marker Out / ECG x1000	Connector for <ul style="list-style-type: none"> <li>An incoming defibrillator synchronization signal from an external patient monitor.</li> <li>Output of R wave marker to an external patient monitor.</li> <li>ECG signal output for use with other equipment such as patient monitors and radio telemetry equipment (1 V/cm of displayed ECG signal).</li> </ul>
NIBP	(Optional) For connecting blood pressure cuff cable.
EtCO <sub>2</sub>	(Optional) For connecting CO <sub>2</sub> monitor cable.
SpO <sub>2</sub>	(Optional) For connecting pulse oximeter cable.

### OneStep Cables

The R Series ships with either a OneStep, or OneStep Pacing cable.

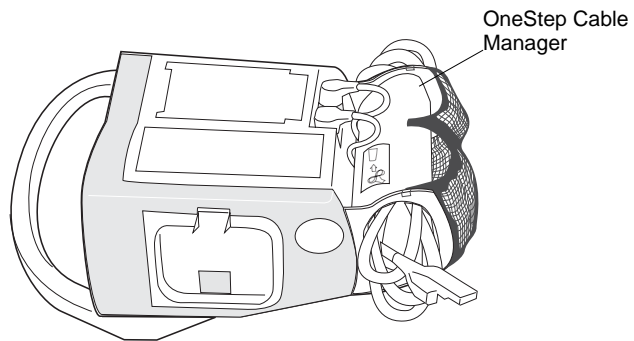
The OneStep Pacing cable has an additional connector that plugs into the rear panel ECG connector. This cable is used with OneStep Pacing electrodes or OneStep Complete electrodes for external pacing and ECG monitoring. Alternatively, you can disconnect the OneStep Pacing cable from the ECG connector and use a 3- or 5-lead ECG cable.



**Figure 2-5. OneStep Cables**

**OneStep Cable Manager (Optional)**

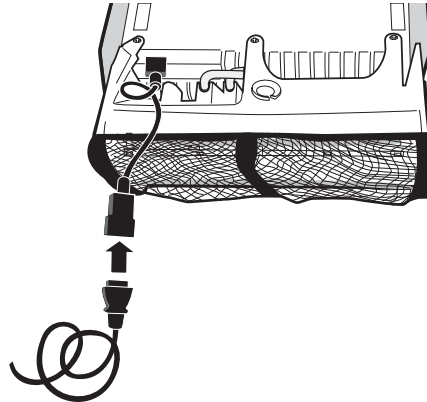
As an option, the OneStep Cable Manager is available to store and organize cables.



**Figure 2-6. The R Series with the Optional OneStep Cable Manager (Side View)**

### Power Cord

The AC power cord is used to operate the R Series unit when battery power is not being used. An additional extension cord is available for use when the cable organizer accessory is attached to the unit. The extension cord plugs into the main AC power cord as shown below.



### External Paddles (Manual Mode Only)



Paddles are defibrillation-proof Type BF equipment.

The external paddles on the R Series device are used for defibrillation and synchronized cardioversion.

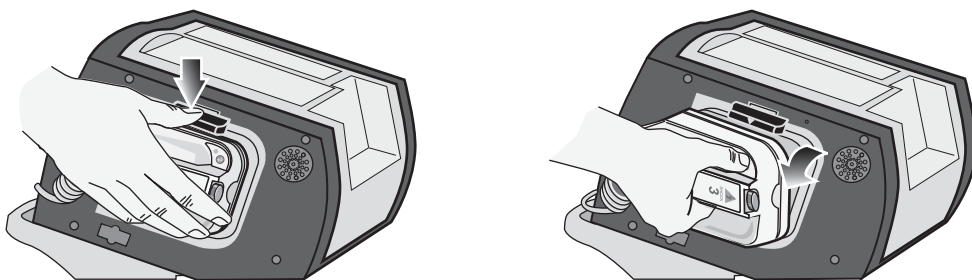
---

**Caution** You cannot use paddles for ECG analysis or pacing.

---

Defibrillation paddles can be used for ECG monitoring when it is not practical to apply ECG electrodes. Press the **LEAD** button to select PADDLES as the ECG source.

The paddles are stowed in wells on either side of the unit. To release the paddles, grasp the handles and then press down on the latch button above each paddle.

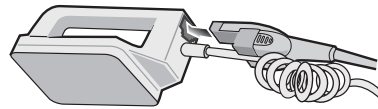


**Figure 2-7. Releasing the Paddles**

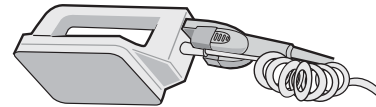


Attach the OneStep cable from the R Series unit to the connector at the base of the apex paddle.

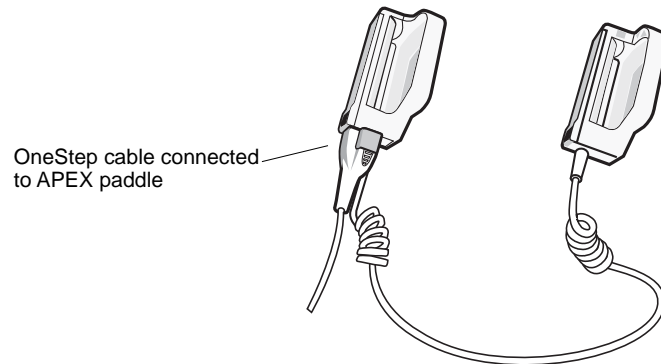
1. Align OneStep cable as shown.



2. Insert OneStep cable into APEX paddle.



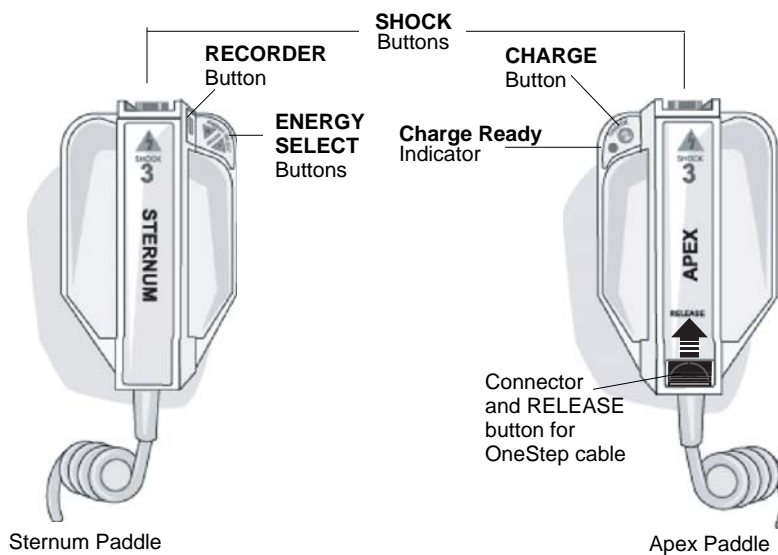
**Figure 2-8. Attaching the OneStep Cable to the APEX Paddle**



**Figure 2-9. OneStep Cable Connected to APEX Paddle**

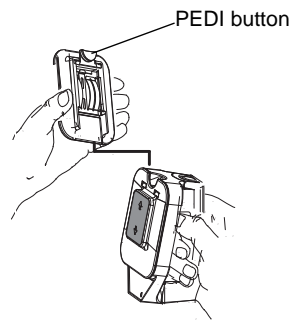
If you need to detach the OneStep cable from the APEX paddles, push the **RELEASE** button (see Figure 2-10) in the direction of the arrow and unplug the OneStep cable.

Refer to Chapter 4, "Manual Defibrillation" before using paddles for defibrillation. The paddles include controls for selecting defibrillation energy, charging, delivering a shock, and turning the stripchart recorder on and off.



**Figure 2-10. External Paddles**

Pediatric-size electrodes are built into the paddle assembly beneath the standard electrode plates. The user must manually adjust energy settings to pediatric levels consistent with their institution’s protocols.



To expose the pediatric plate, press the PEDI button at the top of the paddle, then slide the Adult plate upward.

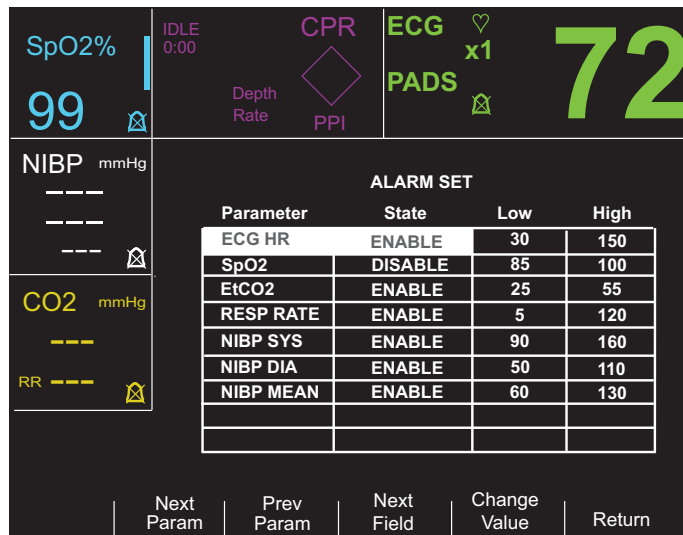
Before replacing the Adult plate, be sure to clean the pediatric plate and surrounding area

**Figure 2-11. Pediatric Plate**

**Note:** The R Series defibrillator also supports ZOLL autoclavable internal handles for use during open chest defibrillation procedures.

## Working with Menus (Manual Mode Only)

For some functions, the screen shows a menu of options with related softkeys for navigating through the menus and making selections and entries.



**Figure 2-12. Example Display Screen**

On the display, highlighting indicates the currently selected item, that is, the item or value you are working with.

The following table summarizes some of the more common softkeys.

Softkey	Action
<b>Next Item</b>	Moves the highlighting down to the next item in a vertical list.
<b>Next Field</b>	Moves the highlighting down to the next item in a horizontal list.
<b>Prev Item</b>	Moves the highlighting up to the previous item in a vertical list.
<b>Next Digit</b>	Moves the highlighting to the right in a series of letters or digits.
<b>Prev Digit</b>	Moves the highlighting to the left in a series of letters or digits.
<b>Inc</b> <b>Inc Digit</b>	Increases the highlighted value or digit. (For example, changes 2 to 3 or B to C).
<b>Dec</b> <b>Dec Digit</b>	Decreases the highlighted value or digit. (For example, changes 2 to 1 or B to A).
<b>Newer</b>	Moves the highlighting to the adjacent item with the more recent date or time.
<b>Older</b>	Moves the highlighting to the adjacent item with the older date or time.
<b>Enter</b>	Accepts the settings with the values currently shown.
<b>Return</b>	Displays the previous menu.
<b>Next Param</b>	Moves the highlighting to the next parameter.
<b>Prev Param</b>	Moves the highlighting to the previous parameter.
<b>Change Value</b>	Changes the value of the selected parameter.

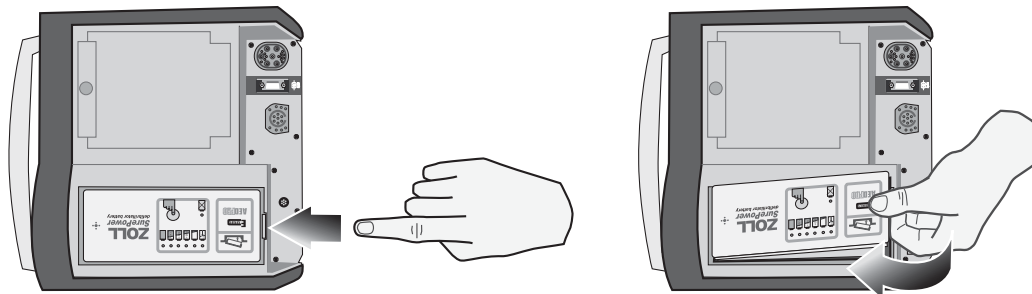
## Common Tasks

Follow the instructions in the subsequent sections for:

- “Replacing a Battery Pack” on page 2-13.
- “Adjusting Display Brightness (Manual Mode Only)” on page 2-14.
- “Using Code Markers (Manual Mode Only)” on page 2-14.

### Replacing a Battery Pack

To remove a battery pack, press the tab on the end of the battery pack inward, and lift the battery pack out of the compartment.



**Figure 2-13. Removing a Battery Pack**

To install a battery pack:

1. Place the end of the battery pack opposite the tab into the end of the compartment closest to the front of the unit.
2. Lower the tabbed end of the battery pack into the compartment and press down on the tabbed end until it locks into place.

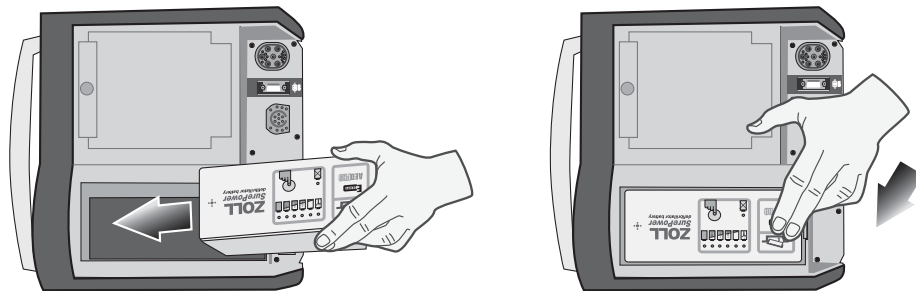


Figure 2-14. Installing a Battery Pack

## Adjusting Display Brightness (Manual Mode Only)

To adjust brightness:

1. Turn the Mode Selector to **ON**.
2. Press the **Manual Mode** softkey.

**Note:** If the *CONFIRM MANUAL MODE* message displays, press the **Confirm** softkey to enter the Manual mode of operation.

3. Press the **Options** softkey.
4. Press the **High Bright** or **Low Bright** softkey to select high and low brightness.

**Note:** Brightness level affects battery run time. Selecting high bright will cause the battery charge to be depleted at a faster rate than when selecting low bright.

## Using Code Markers (Manual Mode Only)

Pressing the **CODE MARKER** softkey causes the unit to display a preconfigured list of clinical actions. Pressing the softkey associated with a particular action causes that action, and 6 seconds of ECG, to be recorded along with a date and time stamp in the Summary Report memory. You can supplement an event summary by manually adding code markers which itemize drugs or treatments administered to the patient.

Up to six Code Markers can be displayed on the screen at one time.



Figure 2-15. Code Markers

The right-most softkey is labeled MORE when there are more than six items on the code marker list. Press the MORE softkey to see the next set of Code Markers displayed above the softkeys.

Separate code marker lists are maintained for DEFIB and PACER modes, thereby enabling the display of appropriate code markers for each particular protocol. (For information on configuring these code marker lists, refer to the *R Series Configuration Guide*.)

The code markers are removed from the display after 10 seconds. If no Code Marker softkey has been pressed during that time, a “default” event mark is stored in Summary Report memory.

---

(This page intentionally left blank.)

# Chapter 3

## Automated External Defibrillator (AED) Operation

---



ZOLL hands-free therapy electrodes are a defibrillation-protected Type BF patient connection.

---

**WARNING!** Use only One-Step Pediatric electrodes to defibrillate patients under 8 years of age in AED mode. Use of adult electrodes with pediatric patients can result in the delivery of excessive energy doses.

---

This chapter describes the recommended method of operation in AED Mode. The R Series unit is configured to operate in compliance with the American Heart Association and European Resuscitation Council Guidelines for Adult Basic Life Support and Use of Automated External Defibrillators.<sup>1,2</sup> If your local protocol requires a different procedure, follow that protocol. (See the *R Series Configuration Guide* for instructions on how to configure the R Series to operate with other treatment protocols.)

This chapter also describes how to switch the AED unit to Manual mode (see “Switching to Manual Mode Operation” on page 3-10).

- 
1. *Circulation*, 2005; 112; IU-19 — IU-34
  2. *Resuscitation* (2005); 671S, S7-S23

The R Series defibrillator is capable of analyzing a patient's ECG rhythm in two different ways. The first mode of analyzing is automatic; the other mode of analyzing is user activated analysis and is initiated by pressing the **ANALYZE** softkey.

Automatic and user activated analysis of a patient's ECG can be performed only when:

- Hands-free therapy electrodes are connected, and making good contact with the patient.
- Mode Selector is turned to ON.

This analysis normally consists of three consecutive 3-second ECG rhythm analyses. If at least two of the three analyses determine that the patient has a shockable rhythm, the unit automatically charges to the preconfigured energy level and prompts the operator to shock the patient. If two or more of the three 3-second ECG analyses do not detect a shockable rhythm, the unit alerts the operator that no shock is advised.

If the shock button is pressed and a shock is successfully delivered, the shock count increments by one and is displayed on the screen.

## AED Operation

### Determine Patient Condition Following Medical Protocols

Verify:

- Unconsciousness.
- Absence of breathing.
- Absence of pulse.

### Begin CPR Following Medical Protocols

Request additional assistance.

### Prepare Patient

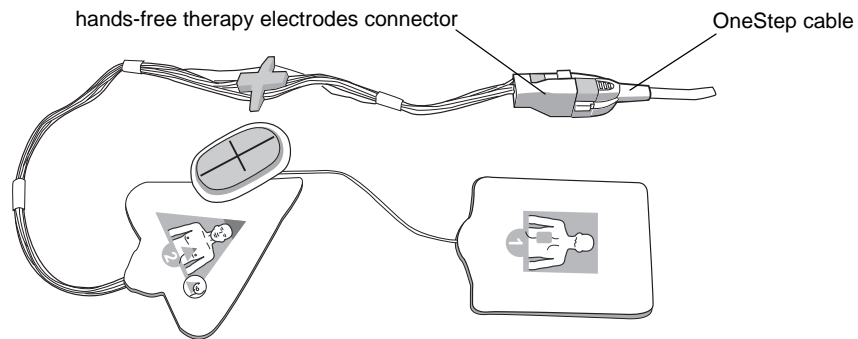
Remove all clothing covering the patient's chest. Dry chest if necessary. If the patient has excessive chest hair, clip or shave it to ensure proper adhesion of the electrodes.

Attach hands-free therapy electrodes according to instructions on the electrode packaging.

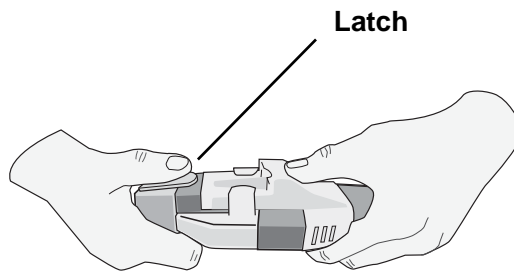
Ensure that the electrodes are making good contact with the patient's skin and are not covering any part of the ECG electrodes.



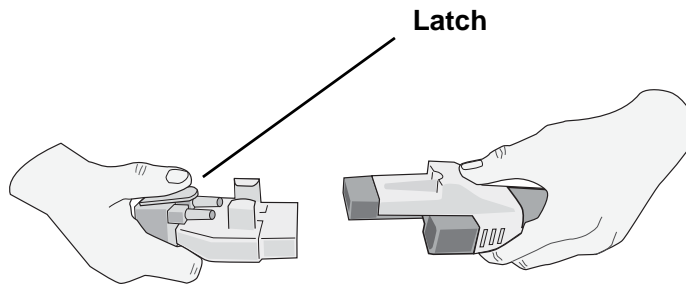
Connect the hands-free therapy electrodes to the OneStep cable if not already connected.



When connecting a OneStep electrode to the OneStep cable, push the two connectors together until the latch clicks, as shown.



When disconnecting the OneStep electrode and OneStep cable, press down the latch with your thumb as shown.



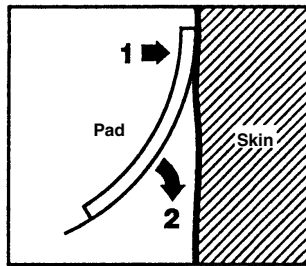
The message *ATTACH PADS* or *CHECK PADS* will be displayed and energy will not be delivered if the therapy electrodes are not making good contact with the patient or if a short circuit exists between the therapy electrodes.

### Therapy Electrode Application

**WARNING!** Poor adherence and/or air under the therapy electrodes can lead to the possibility of arcing and skin burns.

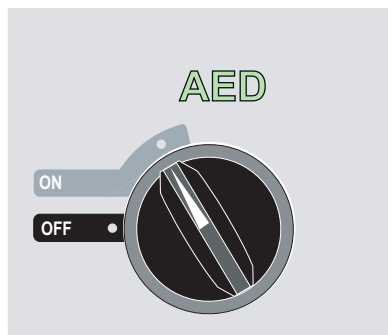
1. Apply one edge of the pad securely to the patient.

- Roll the pad smoothly from the applied edge to the other, being careful not to trap any air pockets between the gel and skin.



**Note:** If it is not possible to place the “BACK” pad on the patient’s back, the pads should be placed in the standard apex-sternum positions. Effective defibrillation will result, but pacing will usually be less effective.

## 1 Select ON



The unit beeps 4 times to indicate that it has passed the power on self test, and the green AED label and the ON mode selector light up on the front panel.

If no hands-free therapy electrodes have been attached to the patient and connected to the R Series, the *ATTACH PADS* message and voice prompt will be issued.



## Energy Select

The default energy selections for adult patients are:

- Shock 1 - 120 joules

- Shock 2 - 150 joules
- Shock 3 - 200 joules

The default energy selections for pediatric patients are:

- Shock 1 - 50 joules
- Shock 2 - 70 joules
- Shock 3 - 85 joules

After the third shock, all subsequent shocks are delivered at the same energy as the third shock in both Adult and Pediatric modes.

## 2 Analyze

---

**WARNING!** Do not analyze the patient ECG during patient movement. A patient must be motionless during ECG analysis. Do not touch the patient during analysis. Cease all movement via stretcher before analyzing the ECG.

---

The R Series automatically begins the analysis of the patient's ECG rhythm, displays an ANALYZING ECG message for 5 seconds, then announces and displays a *STAND CLEAR* message. If therapy electrodes have not been properly connected to the patient, an *ATTACH PADS* or *CHECK PADS* message is displayed and analysis will be inhibited.

**Note:** If the R Series has been configured to perform extra CPR, it displays a *CHECK PULSE* voice prompt and the message appears for 10 seconds. Then it displays an *IF NO PULSE, PERFORM CPR* message along with a voice prompt for the configured duration before analysis begins. You can start an ECG analysis during the CPR interval by pressing the **ANALYZE** softkey.



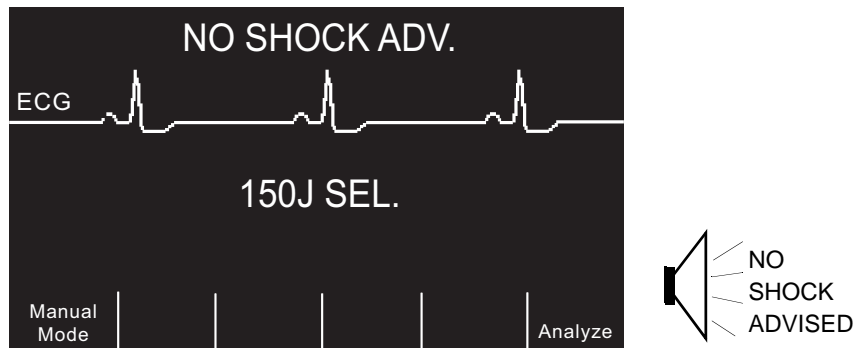
An ANALYZING ECG message is displayed while the patient's ECG is analyzed. Once the analysis is completed, the unit indicates whether or not a shock is advised.

---

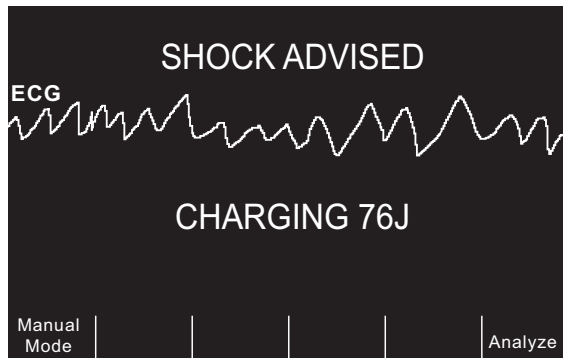
**WARNING!** ECG rhythm analysis does not warn of patient asystole, which is not a shockable rhythm.

---

When a nonshockable rhythm is detected, the unit displays a *NO SHOCK ADV.* message. Immediately begin chest compressions and continue other treatment per protocol.



If the patient's rhythm is shockable, the unit displays a *SHOCK ADVISED* message. The defibrillator begins charging automatically to the preconfigured energy setting and displays a *CHARGING* message.



When charging is completed, the monitor displays the energy level to which the defibrillator has charged, *XXXJ READY*.

### 3 Press SHOCK

---

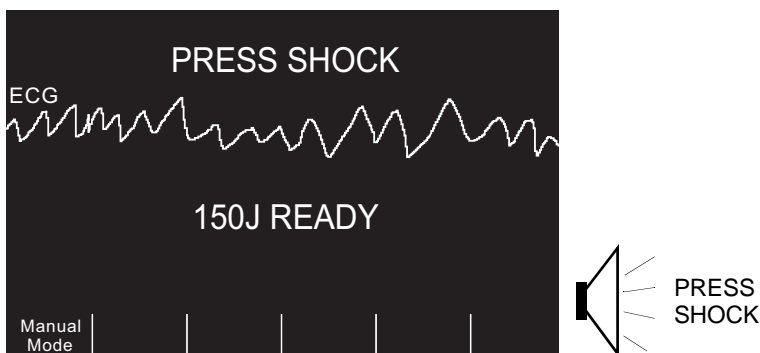
**WARNING!** Warn all persons in attendance of the patient to **STAND CLEAR** prior to defibrillator discharge.

**Do not touch the bed, patient, or any equipment connected to the patient during defibrillation. A severe shock can result. Do not allow exposed portions of the patient's body to come in contact with metal objects, such as a bed frame, as unwanted pathways for defibrillation current may result.**

---

Once the unit is charged to the selected energy, the **SHOCK** button illuminates and the *PRESS SHOCK* message is announced and displayed.

**Note:** Rhythm analysis does not continue after the defibrillator is charged and ready once a decision to shock has been made. The R Series unit will not automatically disarm the defibrillator if the patient's rhythm reverts to a non-shockable rhythm before the shock has been delivered.

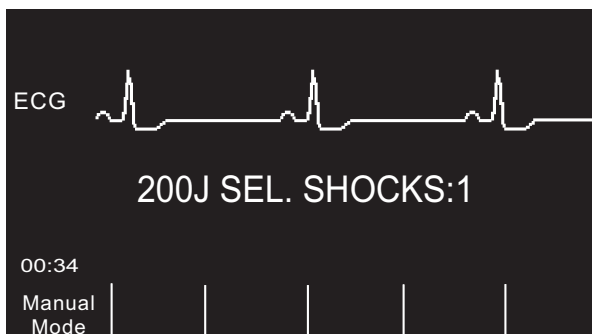


A continuous tone sounds for 20 seconds, followed by an intermittent tone for 10 seconds. You must deliver the shock within this 30 second interval, or the defibrillator will disarm itself.

Press and hold the illuminated **SHOCK** button on the front panel until energy is delivered to the patient.

Observe the patient or ECG response to verify that the shock has been delivered.

After the energy has been delivered to the patient, the display returns to *XXX J SEL. SHOCKS:1*, indicating the number of shocks delivered to the patient.



### Perform CPR

Begin chest compressions and rescue breathing per local protocol as prompted by the unit.

**Note:** If OneStep CPR pads or OneStep Complete pads are connected, the unit monitors the rate and depth of chest compressions and can display *PUSH HARDER* and *GOOD COMPRESSIONS* messages and voice prompts.

### **Repeat Analysis**

After performing CPR for the configured period of CPR, the unit will restart ECG analysis automatically.

**Note:** Reanalysis of the ECG rhythm is inhibited for 3 seconds after a shock.

### **Continue Patient Care**

Continue patient care according to medical protocols.

## **Operating Messages**

The unit uses both audio and visual prompts to present critical information to operators. The following information describes the unit default configuration. If your device has been custom configured, some of the information may be different.

There are 10 voice prompts used in AED mode. Most of these prompts are accompanied by a message displayed on the monitor. The voice prompts are given only once, but the monitor continues to display the message until new action is taken by the operator or the device status changes.

The unit will alternately display two different messages in the same field of the display when two conditions are detected at the same time. For example, a *LOW BATTERY* message may alternately display on the same line of the monitor as the *CHECK PADS* message.

## **Audio and Display Messages**

The display messages and voice prompts that can occur during AED operation are described below.

### **ATTACH PADS**

If the unit is powered on without therapy pads connected to the patient, the *ATTACH PADS* message is announced and displayed.

### **ANALYZING ECG/STAND CLEAR**

The *ANALYZING ECG* message is displayed and the *STAND CLEAR* message is displayed and announced when the ECG analysis starts automatically or after pressing the **ANALYZE** softkey. They indicate that an active ECG analysis is in progress.

### **CHARGING XXXJ**

ECG analysis is still in progress and a potentially shockable rhythm has been detected. The current charge level is displayed.

### **SHOCK ADVISED**

A shockable rhythm has been detected and defibrillation is advised. The selected energy level has not yet been reached. The current energy level is displayed.

### **SHOCK ADVISED/ XXXJ READY**

This message is displayed when a shockable ECG rhythm has been detected and the selected energy is ready to be delivered.

### **PRESS SHOCK**

This message is displayed and announced when the ECG analysis has determined that a shock is advised and the selected energy is ready to be delivered.

### **SHOCKS: XX**

This message displays the number of shocks that have been delivered by the unit since it was powered on. It resets to 0 after the unit has been off for more than 10 seconds.

### **NO SHOCK ADVISED**

When ECG analysis detects a nonshockable rhythm, this message displays and continues for 10 seconds following completion of the analysis.

### **CHECK PULSE**

If configured to do so, this message is displayed and announced in the following situations:

- After a No Shock Advised analysis result
- During the CPR interval after a No Shock Advised analysis result
- During the CPR interval after delivery of the final shock in a stacked shock sequence
- After the final shock is delivered

### **IF NO PULSE, PERFORM CPR**

If configured to do so, this message is displayed and announced in the following situations:

- During the CPR interval after a No Shock Advised analysis result
- During the CPR interval after delivery of the final shock in a stacked shock sequence
- During the start of extra CPR interval

### **PERFORM CPR**

If configured to do so, this message is displayed and announced in the following situations:

- During the CPR interval after a No Shock Advised analysis result
- During the CPR interval after delivery of the final shock in a stacked shock sequence

### **PUSH HARDER**

This message is announced when the chest compressions applied during CPR are not forceful enough.

### **GOOD COMPRESSIONS**

This message is announced when the chest compressions applied during CPR are forceful enough.

### **CHECK PADS**

This message is displayed and announced when the therapy pads have been disconnected from the patient.

### ELAPSED TIME

When enabled, this feature indicates the elapsed time since the unit was first turned on. It is displayed in the lower left corner. The elapsed time is displayed in MM:SS format up to 99:59. If the unit is on for over 100 minutes, the elapsed time will roll over to 0. The elapsed time will be maintained for up to 10 seconds after power down. This will give the operator adequate time to change the unit's battery without resetting the elapsed time.

### FULLY RELEASE

If configured to do so, this message reminds rescuers to lift (fully release) their hands from the patient's chest during compressions to allow full recoil. By default, this feature is not enabled.

### MONITOR

The *MONITOR* message appears when the ECG cable is connected to its input connector and attached to the patient, but the therapy electrodes are not connected. The unit selects lead II and sets the ECG size automatically (you cannot change the Lead and ECG size).

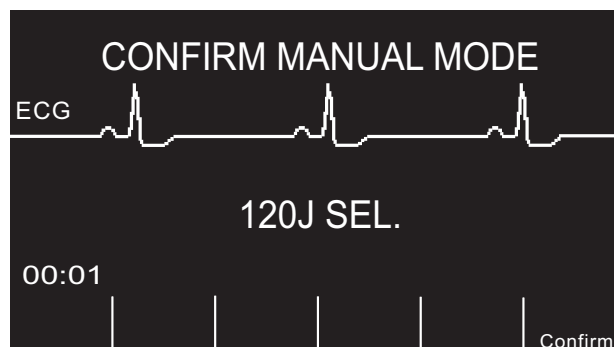
## Switching to Manual Mode Operation

Press the **Manual Mode** softkey on the front panel of the unit to enter the Manual mode of operation.



The message *CONFIRM MANUAL MODE* and the **Confirm** softkey will be displayed. Press the **Confirm** softkey to enter the Manual mode of operation. If the **Confirm** softkey is not pressed within 10 seconds, the unit will revert back to AED operation.

**Note:** If the unit has been configured not to confirm the transition from AED mode to Manual mode, the unit will immediately enter Manual mode.





When changing from AED mode to Manual mode, the current selected energy level is maintained.

**Note:** To transfer back to AED mode from Manual mode, power down the unit for more than 10 seconds and then power it back up.



# Chapter 4

## Manual Defibrillation

---



Paddles are a defibrillation-protected Type BF patient connection.



ECG leads are a defibrillation-protected Type CF patient connection.

### Emergency Defibrillation Procedure with Paddles

---

**WARNING!** To avoid risk of electrical shock, do not allow electrolyte gel to accumulate on hands or paddle handles.

When defibrillating with paddles, use your thumbs to operate the **SHOCK** buttons in order to avoid inadvertent operator shock. No portion of the hands should be near the paddle plates.

---

### Determine the Patient's Condition Following Local Medical Protocols

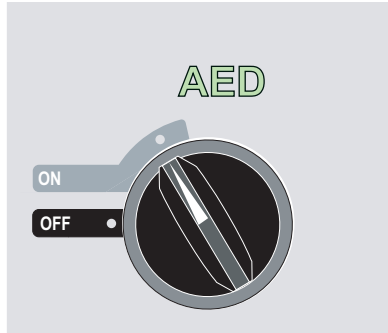
Verify:

- Unconsciousness.
- Absence of breathing.
- Absence of pulse.

## Begin CPR Following Local Medical Protocols

Request additional assistance.

### 1 Select ON



The unit beeps 4 times to indicate that it has passed the power on self test, and the green AED label and the ON mode selector light up on the front panel.

Press the **Manual Mode** softkey on the front panel of the unit to enter the Manual mode of operation.

The message *CONFIRM MANUAL MODE* and the **Confirm** softkey will be displayed. Press the **Confirm** softkey to enter the Manual mode of operation. If the **Confirm** softkey is not pressed within 10 seconds, the unit will revert back to AED operation.

**Note:** If the unit has been configured not to confirm the transition from AED mode to Manual mode, the unit will immediately enter Manual mode.

The control buttons for Manual mode light up on the front panel and the unit automatically defaults to 120 joules or the preconfigured first shock energy selection.

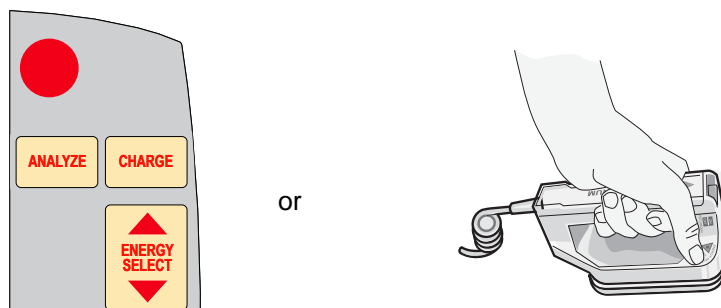
**Note:** Defibrillator PADDLES are selected as the ECG source when the instrument is changed to Manual mode with paddles connected to the OneStep cable.

### Energy Select

Look at the Display and verify the energy is appropriate. Unless internal handles are connected to the OneStep cable, the default energy selections for adult patients are:

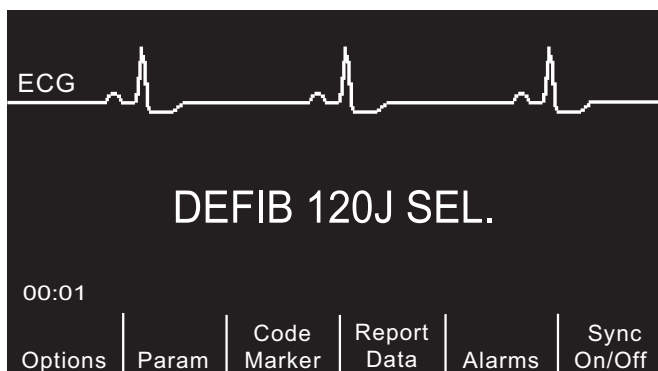
- Shock 1 - 120 joules
- Shock 2 - 150 joules
- Shock 3 - 200 joules

If medical protocol allows, you may select a different energy level using the up and down arrow buttons. One pair is located on the front panel of the unit; the other pair is located on the sternum paddle.



**Note:** Neonatal and pediatric defibrillator energy levels should be selected based on site-specific protocols.

The selected energy level is shown as *DEFIB XXXJ SEL.* on the display.



If you have configured Shocks 1, 2, and 3 to escalating energy levels (see the *R Series Configuration Guide* for instructions), the R Series automatically sets the energy to the preconfigured Energy Level: Shock 1, 2, 3 setting at power-up and after each of the first two shocks. The *ENERGY INCREMENTED* message will be displayed after Shocks 1 and 2 are delivered. Manually changing the energy level outside the preprogrammed sequence and delivering a shock disables the automatic escalation function.

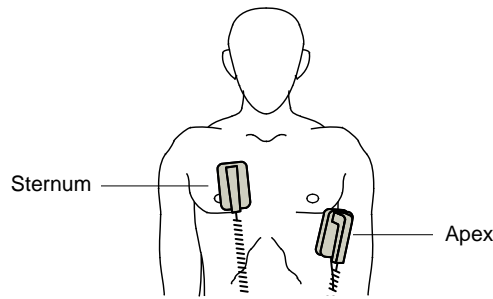
### Prepare Paddles

Release the paddles, apply a liberal amount of electrolyte gel to the electrode surface of each paddle, and rub the electrode surfaces together to evenly distribute the applied gel. (You can substitute electrode gel patches for the gel.)

### Apply Paddles to Chest

Apply the paddles firmly to the anterior wall of the chest. Place the sternum paddle to the right of the patient's sternum (patient's right), just below the clavicle.

Place the apex paddle on the chest wall, just below and to the left of the patient's left nipple, along the anterior-axillary line.



Rub the paddles against the skin to maximize the paddle-to-patient contact.

---

**WARNING!** Do not permit gel to accumulate between the paddle electrodes on the chest wall (gel bridge). This could cause burns and reduce the amount of energy delivered to the heart.

If using defibrillator gel pads, make sure that the size of the pad is large enough to cover the entire paddle electrode area.

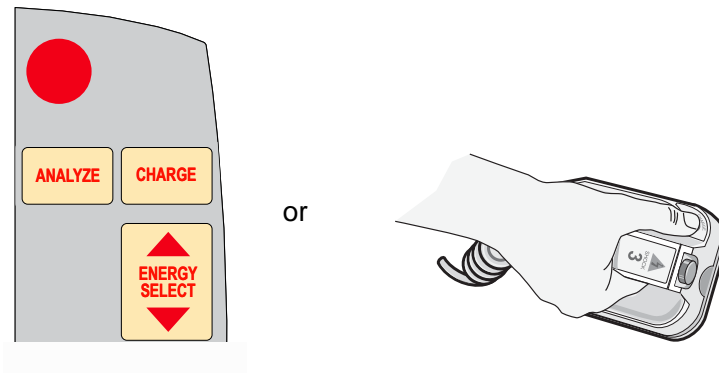
---

The paddles may be used for ECG monitoring in emergency situations when time does not allow connection of standard ECG monitoring electrodes.

If an ECG cable and ECG electrodes are in use, press the **LEAD** button to select the desired ECG lead.

## 2 Charge Defibrillator

Press the **CHARGE** button on the apex handle or on the front panel.



If both **SHOCK** buttons on the paddles are depressed when the **CHARGE** button is activated, the unit does not charge and a *RELEASE SHOCK BUTTON* message appears on the display.

To increase or decrease the selected energy after you have pressed the **CHARGE** button, use the defibrillator **ENERGY SELECT** buttons on either the sternum paddle or the defibrillator front panel.

---

**Caution** Changing the selected energy while the unit is charging or charged causes the defibrillator to disarm itself. Press the **CHARGE** button again to charge the unit to the newly selected energy level.

---

After charging to the selected energy, the charge indicator on the apex paddle lights. A distinctive charge ready tone sounds, and the message *DEFIB XXXJ READY* is displayed. The defibrillator is now ready to discharge.

### 3 Deliver Shock

---

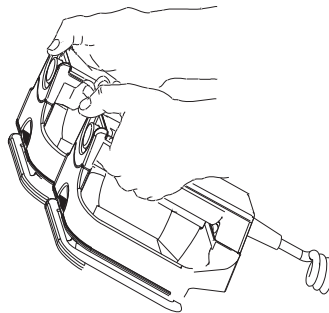
**WARNING!** Warn all persons in attendance of the patient to **STAND CLEAR** prior to defibrillator discharge.

**Do not touch the bed, patient, or any equipment connected to the patient during defibrillation. A severe shock can result. Do not allow exposed portions of the patient's body to come into contact with metal objects, such as a bed frame, as unwanted pathways for defibrillation current may result.**

---

Apply a force of 10 - 12 kilograms (22 - 26.4 pounds) to each paddle in order to minimize patient impedance and achieve optimal results.

Using your thumbs, simultaneously press and hold both **SHOCK** buttons (one on each paddle) until energy is delivered to the patient.



---

**Caution** Use only thumbs to depress the **SHOCK** buttons. Failure to do so could result in the inadvertent depression of the **ENERGY SELECT** buttons, causing the defibrillator to disarm itself.

---

Once the energy is delivered, the display simultaneously shows *XXXJ DELIVERED* and *DEFIB XXXJ SEL*. After approximately 5 seconds, the *XXXJ DELIVERED* message disappears, and the *DEFIB XXXJ SEL* message remains to indicate the selected energy level.

**Note:** If the defibrillator is not discharged within 60 or 120 seconds (user configurable) after reaching the selected energy level, the unit automatically disarms itself.

During the 10 seconds prior to disarming, the charge ready tone beeps intermittently. The charge ready tone then stops, the charge indicator light goes off, and the monitor message changes to *DEFIB XXXJ SEL*. Press the **CHARGE** button to recharge the unit.

## Autoclavable External Paddles

ZOLL Autoclavable External Paddles are available for use with manually operated ZOLL defibrillators when sterile conditions must be maintained during defibrillation.

# Emergency Defibrillation Procedure with Hands-Free Therapy Electrodes



ZOLL hands-free therapy electrodes are a defibrillation-protected Type BF patient connection.



ECG leads are a defibrillation-protected Type CF patient connection.

## Determine the Patient's Condition Following Local Medical Protocols

Verify:

- Unconsciousness.
- Absence of breathing.
- Absence of pulse.

## Begin CPR Following Medical Protocols

Request additional assistance.

## Prepare Patient

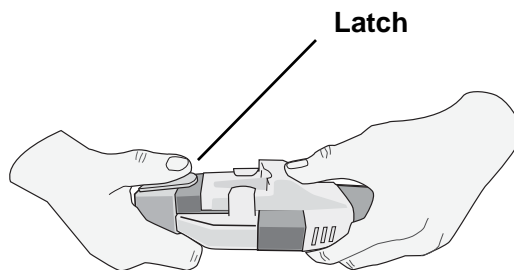
Remove all clothing covering the patient's chest. Dry chest if necessary. If the patient has excessive chest hair, clip or shave it to ensure proper adhesion of the electrodes.

Attach hands-free therapy electrodes according to instructions on the electrode packaging.

Ensure that the therapy electrodes are making good contact with the patient's skin and are not covering any part of the ECG electrodes.

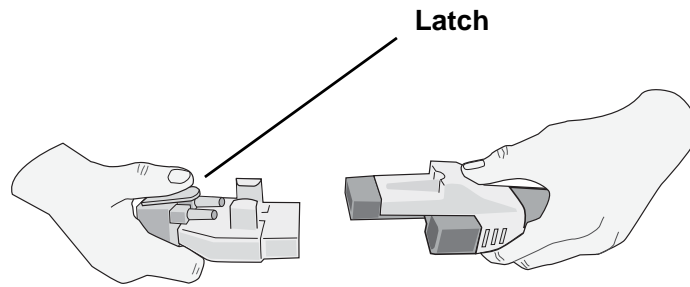
Connect the hands-free therapy electrodes to the OneStep cable if not preconnected.

When connecting a OneStep electrode to the OneStep cable, push the two connectors together until the latch clicks, as shown.





When disconnecting the OneStep electrode and OneStep cable, press down the latch with your thumb as shown.



If defibrillation electrodes are not making good contact with the patient's skin, the unit issues the messages *CHECK PADS* and *POOR PAD CONTACT* and does not allow delivery of energy. If a short circuit exists between the electrodes, the unit issues the message *DEFIB PAD SHORT*.

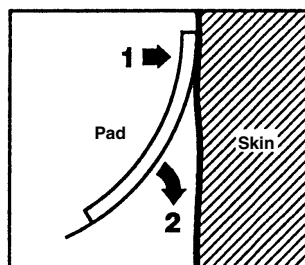
### Therapy Electrode Application

---

**WARNING!** Poor adherence and/or air under the therapy electrodes can lead to the possibility of arcing and skin burns.

---

1. Apply one edge of the pad securely to the patient.
2. Roll the pad smoothly from the applied edge to the other, being careful not to trap any air pockets between the gel and skin.



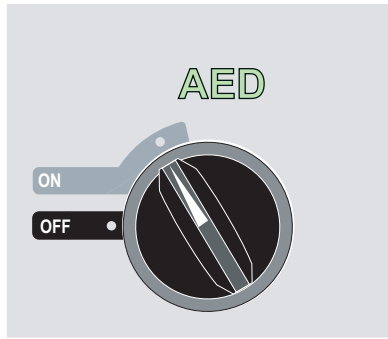
**Note:** If it is not possible to place the “BACK” electrode on the patient's back, place the electrodes in the standard apex-sternum positions. Effective defibrillation results, but pacing will usually be less effective.

---

**WARNING!** Application of adult electrodes to a pediatric patient will result in the automatic selection of adult energy levels. If needed, manually adjust the energy settings based on site-specific protocols.

---

## 1 Select ON



The unit beeps 4 times to indicate that it has passed the power on self test, and the green AED label and the ON mode selector light up on the front panel.

Press the **Manual Mode** softkey on the front panel of the unit to enter the Manual mode of operation.

The message *CONFIRM MANUAL MODE* and the **Confirm** softkey will be displayed. Press the **Confirm** softkey to enter the Manual mode of operation. If the **Confirm** softkey is not pressed within 10 seconds, the unit will revert back to AED operation.

**Note:** If the unit has been configured not to confirm the transition from AED mode to Manual mode, the unit will immediately enter Manual mode.

The control buttons for Manual mode light up on the front panel and the unit automatically defaults to 120 joules or the preconfigured first shock energy selection.

PADS are selected as the ECG source when the instrument is turned to Manual mode and paddles are not connected to the OneStep cable. You may select any of the other ECG leads by pressing the front panel LEAD button.

### Energy Select

Look at the display, and verify the selected energy is appropriate. The default energy selections for adult patients are:

- Shock 1 - 120 joules
- Shock 2 - 150 joules
- Shock 3 - 200 joules

When used with OneStep Pediatric electrodes, the default energy selections are:

- Shock 1 - 50 joules
- Shock 2 - 70 joules
- Shock 3 - 85 joules

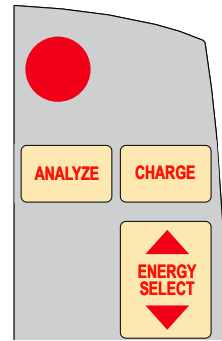
---

**WARNING!** When used with other pediatric defibrillation electrodes, defibrillator energies must be set manually based on site-specific institutional protocols for pediatric defibrillation.

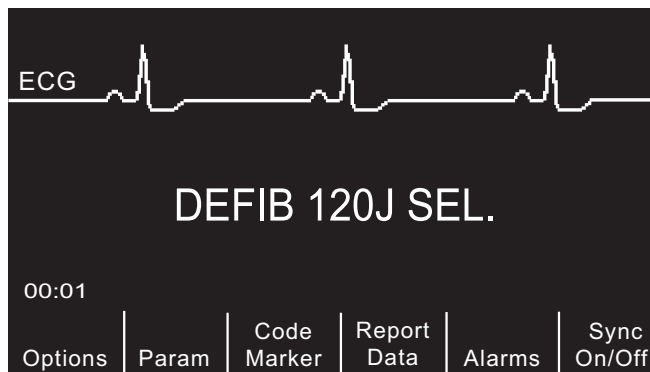
---

After the third shock, all subsequent shocks are delivered at the same energy as the third shock in both Adult and Pediatric modes.

If medical protocol allows, you may select a different energy level using the **ENERGY SELECT** buttons on the front panel.



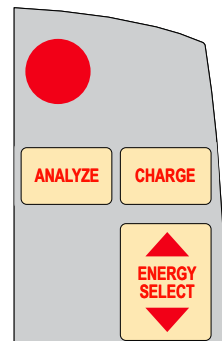
The selected energy level is shown as *DEFIB XXXJ SEL.* on the display.



If you have configured Shocks 1, 2, and 3 to escalating energy levels (see the *R Series Configuration Guide* for instructions), the R Series automatically sets the energy to the preconfigured Energy Level: Shock 1, 2, 3 setting at power-up and after each of the first two shocks. The *ENERGY INCREMENTED* message will be displayed after Shocks 1 and 2 are delivered. Manually changing the energy level outside the preprogrammed sequence and delivering a shock disables this function.

## 2 Charge Defibrillator

Press the **CHARGE** button on the front panel.



To increase or decrease the selected energy after you have pressed the **CHARGE** button, use the defibrillator **ENERGY SELECT** buttons.

---

**Caution** Changing the selected energy while the unit is charging or charged causes the defibrillator to disarm itself. Press the **CHARGE** button again to charge the unit.

---

After charging to the selected energy, the **SHOCK** button on the front panel lights. A distinctive charge ready tone sounds and the *DEFIB XXXJ READY* is displayed. The defibrillator is now ready to discharge.

### 3 Deliver Shock

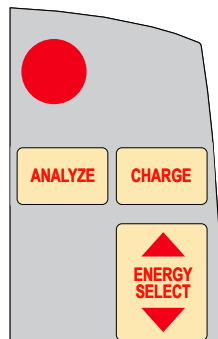
---

**WARNING!** Warn all persons in attendance of the patient to **STAND CLEAR** prior to defibrillator discharge.

**Do not touch the bed, patient, or any equipment connected to the patient during defibrillation. A severe shock can result. Do not allow exposed portions of the patient's body to come into contact with metal objects, such as a bed frame, as unwanted pathways for defibrillation current may result.**

---

Press and hold the **SHOCK** button until energy is delivered to the patient.



**Note:** If the defibrillator is not discharged within 60 or 120 seconds (user configurable) after reaching the selected energy level, the unit automatically disarms itself.

During the 10 seconds prior to disarming, the charge ready tone beeps intermittently. The charge ready tone then stops, the **SHOCK** button light goes off, and the monitor message changes to *DEFIB XXXJ SEL*. Press the **CHARGE** button to recharge the unit.

Once the energy is delivered, the display simultaneously shows *XXXJ DELIVERED* and *DEFIB XXXJ SEL*. After approximately 5 seconds, the *XXXJ DELIVERED* message disappears and the *DEFIB XXXJ SEL* message remains to indicate the selected energy level.

## Autoclavable Electrodes

ZOLL Autoclavable Internal Handles are designed for use with a manually operated ZOLL defibrillator to defibrillate the heart during open chest procedures. Two types of Autoclavable Internal Handles are available:

- Molded Autoclavable Internal handles with integrated electrode spoons
- Autoclavable Internal Handles with removable internal defibrillation electrodes

When these internal handles are used, the R Series defibrillator can operate only in Manual mode even if the unit supports Advisory mode. When an internal handle set is connected to the R Series, it automatically limits energy output to a maximum of 50 joules.

For step-by-step procedures for open chest defibrillation as well as important cleaning and sterilization of the autoclavable electrodes, refer to the *Autoclavable Internal Handle and Electrode Operator's Guide*.

---

(This page intentionally left blank.)

# Chapter 5

## Advisory Defibrillation

---



ZOLL hands-free therapy electrodes are a defibrillation-protected Type BF patient connection.

When the Mode Selector is turned to ON, the unit is in Manual mode, and hands-free therapy electrodes are used, the R Series can identify shockable rhythms using its built in ECG analysis capability. You must read the advisory messages, charge the defibrillator to the preconfigured or user-selected energy level (if automatic charge is disabled), and deliver treatment to the patient when required by protocol and patient condition.

The advisory function can be activated only when:

- Hands-free therapy electrodes are connected and selected as the ECG source.
- Hands-free therapy electrodes are properly connected to the patient.
- The Mode Selector is turned to ON and the unit is in Manual mode.

---

**WARNING!** Use only pediatric electrodes to defibrillate patients under 8 years of age in Advisory mode. Use of adult electrodes with pediatric patients can result in the delivery of excessive energy doses.

---

# Advisory Defibrillation Procedure

## Determine the Patient's Condition Following Local Medical Protocols

Verify:

- Unconsciousness.
- Absence of breathing.
- Absence of pulse.

## Begin CPR Following Local Medical Protocols

Request additional assistance.

## Prepare Patient

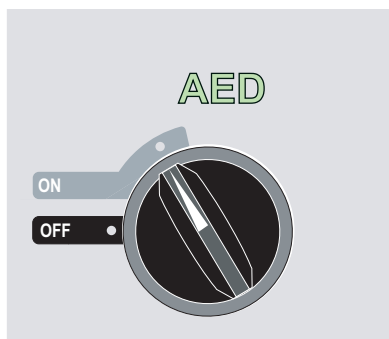
Remove all clothing covering the patient's chest. Dry chest if necessary. If the patient has excessive chest hair, clip or shave it to ensure proper adhesion of the electrodes.

Attach hands-free therapy electrodes according to instructions on the electrode packaging and as described in "Therapy Electrode Application" on page 4-7.

Ensure that the electrodes are making good contact with the patient's skin and are not covering any part of the ECG electrodes.

If therapy electrodes are not making good contact with the patient's skin, the unit issues the messages *CHECK PADS* and *POOR PAD CONTACT* and does not allow delivery of energy. If a short circuit exists between the electrodes, the unit issues the message *DEFIB PAD SHORT*.

## 1 Select ON



The unit beeps 4 times to indicate that it has passed the power on self test, and the green AED label and the ON mode selector light up on the front panel.

Press the **Manual Mode** softkey on the front panel of the unit to enter the Manual mode of operation.

The message *CONFIRM MANUAL MODE* and the **Confirm** softkey will be displayed. Press the **Confirm** softkey to enter the Manual mode of operation. If the **Confirm** softkey is not pressed within 10 seconds, the unit will revert back to AED operation.



**Note:** If the unit has been configured not to confirm the transition from AED mode to Manual mode, the unit will immediately enter Manual mode.

The control buttons for Manual mode light up on the front panel and the unit displays *DEFIB 120J SEL* on the monitor.

### Energy Select

The default energy selections for adult patients are:

- Shock 1 - 120 joules
- Shock 2 - 150 joules
- Shock 3 - 200 joules

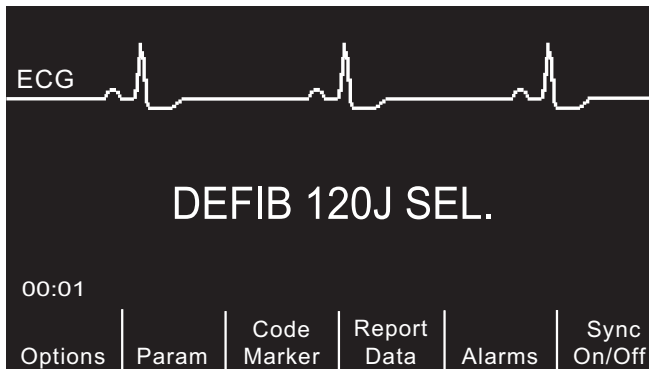
When used with OneStep Pediatric electrodes, the default energy selections for pediatric patients are:

- Shock 1 - 50 joules
- Shock 2 - 70 joules
- Shock 3 - 85 joules

**WARNING!** Use only OneStep Pediatric electrodes to defibrillate patients under 8 years of age in Advisory mode. Use of adult electrodes, or pediatric electrodes other than OneStep Pediatric electrodes, can result in the delivery of excessive energy doses.

After the third shock, all subsequent shocks are delivered at the same energy as the third shock in both Adult and Pediatric modes.

If medical protocols allow, you may select a different energy level using the energy select up and down arrow buttons on the front panel. The new energy setting displays on the monitor.

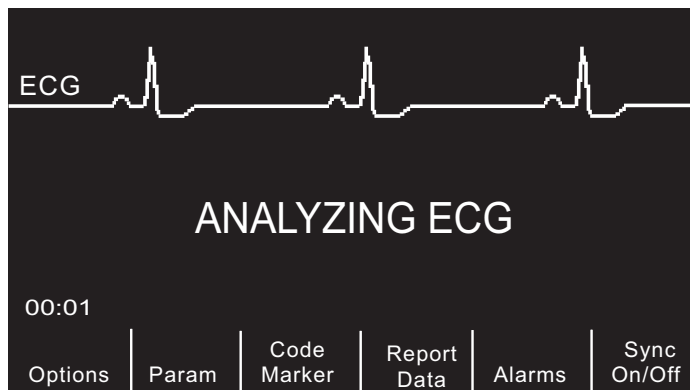


If you have configured SHOCK 1, 2, and 3 to escalating energy levels, and then you manually change the energy level outside preconfigured SHOCK 1, 2, 3 sequence and deliver a shock, it disables the automatic energy escalation. See the Energy Level: Shock 1, 2, 3 section of the *R Series Configuration Guide* for more details.

## 2 Press ANALYZE Button

**WARNING!** Keep patient motionless during ECG analysis. Do not touch the patient during analysis. Cease all movement via stretcher before analyzing the ECG.

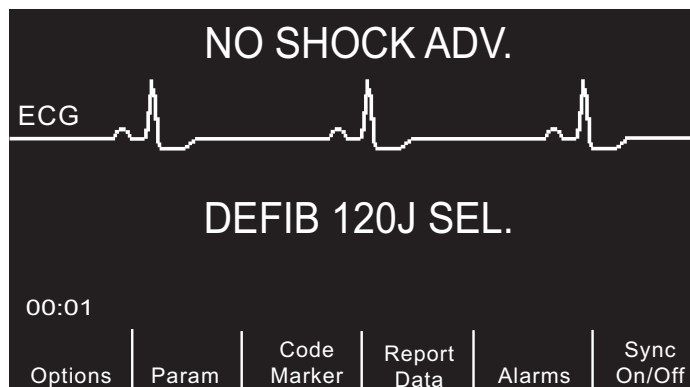
Press the **ANALYZE** button to begin the analysis of the patient's ECG rhythm and to determine if a shockable rhythm is present.



An *ANALYZING ECG* message is displayed for 6 to 12 seconds while the patient's ECG is analyzed. Once the analysis is completed, the unit indicates whether or not a shock is advised.

The analysis normally consists of three consecutive 3-second ECG rhythm analyses. If at least two of the three analyses determine that the patient has a shockable rhythm, the unit automatically charges to the preconfigured energy level and prompts the operator to shock the patient. If two or more of the three 3-second ECG analyses do not detect a shockable rhythm, the unit alerts the operator that no shock is advised.

**WARNING!** ECG rhythm analysis does not warn of patient asystole, which is not a shockable rhythm.



When a nonshockable rhythm is detected, the unit displays a *NO SHOCK ADV.* message. Follow the local protocols to continue CPR or other life support, and re-analyze the ECG at appropriate intervals.

**Note:** When a nonshockable rhythm is detected, the R Series does not prevent the user from manually defibrillating the patient.

When a shockable rhythm is detected (ventricular fibrillation or wide-complex tachycardia with heart rate > 150), one of the following occur:

- Units with the automatic charge option enabled automatically charge to the preconfigured or user selected energy setting.
- Units with the automatic charge option disabled will alternately display the messages *SHOCK ADVISED* and *PRESS CHARGE*. Press the **CHARGE** button.

Regardless of the analysis result, the user can control the defibrillator manually. For example, the user can defibrillate the patient even if the advisory function issues a NO SHOCK ADV. message.



### 3 Press SHOCK

**WARNING!** Warn all persons in attendance of the patient to **STAND CLEAR** prior to defibrillator discharge.

**Do not touch the bed, patient, or any equipment connected to the patient during defibrillation. A severe shock can result. Do not allow exposed portions of the patient's body to come in contact with metal objects, such as a bed frame, as unwanted pathways for defibrillation current may result.**

Once the unit is charged to the selected energy, the **SHOCK** button illuminates and the *PRESS SHOCK* message is displayed. Simultaneously, the monitor displays the energy level to which the defibrillator is charged, *DEFIB XXXJ READY*.

**Note:** Rhythm analysis does not continue after the defibrillator is charged and ready once a decision to shock has been made. The R Series unit will not automatically disarm the defibrillator if the patient's rhythm reverts to a non-shockable rhythm before the shock has been delivered.



A continuous tone sounds for 50 seconds, followed by an intermittent beeping for 10 seconds. You must deliver the shock within this 60 second interval, or the defibrillator will disarm itself.

**Note:** This interval is user configurable and can be set to either 60 or 120 seconds.

Press and hold the illuminated **SHOCK** button on the front panel until energy is delivered to the patient. An *XXXJ DELIVERED* message appears on the display for approximately 5 seconds.

Watch the patient or ECG response to verify that the shock has been delivered.

After the energy has been delivered to the patient, the display returns to *DEFIB XXX J SEL*.

### Perform CPR

Begin chest compressions and rescue breathing per local protocol.

### Repeat Analysis

Press the **ANALYZE** button to restart an ECG analysis and determine if additional shocks are required.

**Note:** Reanalysis of the ECG rhythm is inhibited for 3 seconds after each shock.

### Continue Patient Care

Continue patient care according to medical protocols.

---

## Advisory Function Messages

### SELECT DEFIB MODE

Displayed if any of the buttons on the right side front panel (**SHOCK**, **ANALYZE**, **CHARGE**, **ENERGY SELECT**) are pressed while in Data Transfer mode. To enable the defibrillator in Manual mode, press the **Exit Transfer** softkey, or quickly turn the Mode Selector to **OFF** and then **ON**.

### SELECT PADS

Displayed if the **ANALYZE** button is pressed while the device is operating in any ECG lead other than “PADS.” Press the **LEAD** button until “PADS” is selected.

### REMOVE SYNC

Displayed if the **ANALYZE** button is pressed while the device is in Sync mode. Turn off Sync mode by pressing the **SyncOn/Off** softkey. Press the **ANALYZE** button again to initiate ECG rhythm analysis.

## Warning Messages

Warning messages prompt the operator to check the patient, the unit, the electrodes and/or connections.

### NOISY ECG / RETRY ANALYSIS

A *NOISY ECG* message alternating with a *RETRY ANALYSIS* message is displayed for 5 seconds when the unit detects a noisy ECG signal during ECG analysis. Check and adjust electrode placement and cable connections to help eliminate the noise source. Keep patient motionless during ECG analysis. Press the **ANALYZE** button again to begin ECG analysis.

### CHECK PATIENT

The unit has detected a shockable rhythm during continuous background ECG analysis (i.e., Smart Alarms™). The prompt is given only when the heart rate alarms are enabled and the unit detects a shockable rhythm. The screen message persists as long as a shockable rhythm is being detected. Press the **ANALYZE** button to begin ECG analysis.

**Note:** This CHECK PATIENT analysis function operates continuously when heart rate alarms are enabled and does not require pressing the **ANALYZE** button for operation.

### CHECK PADS / POOR PAD CONTACT

The therapy electrodes are not properly attached to the patient, or the cable connections have become loose.

Check that the therapy electrodes are making good contact with the patient's skin and that all cables are securely connected. This voice prompt will not sound if the therapy electrodes were not previously connected to the patient.


(This page intentionally left blank.)


# Chapter 6

## Synchronized Cardioversion

---

**Note:** This option is only available in Manual mode.

 Paddles are a defibrillation-protected Type BF patient connection.

 ECG leads are a defibrillation-protected Type CF patient connection.

---

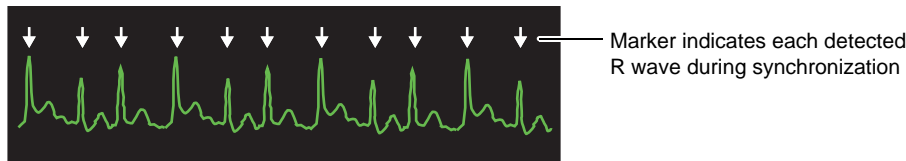
**WARNING!** Only skilled personnel trained in Advanced Cardiac Life Support and familiar with equipment operation should perform synchronized cardioversion. The precise cardiac arrhythmia must be determined before attempting defibrillation or cardioversion.

**Before attempting synchronized cardioversion, ensure that ECG signal quality is sufficient to minimize the risk of synchronizing on artifact.**

---

Certain arrhythmias, such as ventricular tachycardia, atrial fibrillation, and atrial flutter, require synchronizing the defibrillator discharge with the ECG R-wave to avoid the induction of ventricular fibrillation. In this case, a synchronizing (Sync) circuit within the defibrillator detects the patient's R-waves. When the **SHOCK** button (or buttons, if using paddles) is pressed and held, the unit discharges with the next detected R-wave, thus avoiding the vulnerable T-wave segment of the cardiac cycle.

When in the Sync mode, the unit displays markers (↓) above the ECG trace to indicate the points in the cardiac cycle (R waves) where discharge can occur.



Verify that markers are clearly visible on the monitor and their location is appropriate and consistent from beat to beat. If necessary, use the **LEAD** and **SIZE** buttons to establish settings that yield the most consistent Sync marker pattern.

The **Sync On/Off** softkey may be highlighted for clearer visibility, if desired. This is off by default. Refer to the *R Series Configuration Guide* for instructions on how to turn on the highlighting.



The synchronized cardioversion procedure for ZOLL hands-free therapy electrodes is identical to that for paddles with the exception of the **SHOCK** button location.

The R Series defibrillator supports two types of synchronized cardioversion:

- **Synchronized Cardioversion** — The R Series monitors the patient’s ECG and synchronizes shock delivery with this ECG source. For instructions, refer to “Synchronized Cardioversion Procedure” below.
- **Remote Synchronized Cardioversion** — An external device (such as a patient monitor) monitors the patient’s ECG and provides a synchronization pulse to the R Series’ Sync In/Marker Out connector. The R Series synchronizes shock delivery with these external pulses.

**Note:** When using the Remote Sync function, the procedure and displayed information are different. Make sure to follow the instructions for Remote Synchronized Cardioversion on page 6-5.

## Synchronized Cardioversion Procedure

### Determine the Patient’s Condition and Provide Care Following Local Medical Protocols

#### Prepare Patient

Remove all clothing covering the patient’s chest. Dry chest if necessary. If the patient has excessive chest hair, clip or shave it to ensure proper adhesion of the electrodes.

Attach ECG electrodes as described in “Monitoring Electrodes Attachment” on page 10-3.

A standard ECG cable and ECG electrodes are recommended for use during cardioversion. Hands-free therapy electrodes may be used as an ECG source. Signal quality will be equal to that of standard leads except immediately following a discharge when there may be more noise due to muscle tremors, especially if an electrode is not in complete contact with the skin.



Attach hands-free therapy electrodes according to instructions on the electrode packaging and as described in “Therapy Electrode Application” on page 4-7.

Ensure that the therapy electrodes are making good contact with the patient’s skin and are not covering any part of any other electrodes.

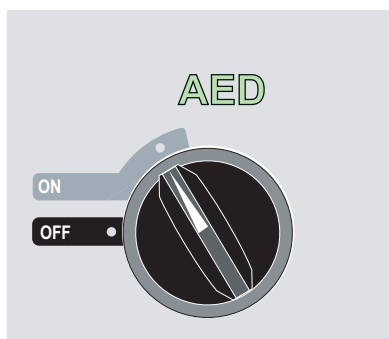
Connect the hands-free therapy electrodes to the OneStep cable if not preconnected.

If therapy electrodes are not making good contact with the patient’s skin, the unit issues the messages *CHECK PADS* and *POOR PAD CONTACT* and does not allow delivery of energy. If a short circuit exists between the electrodes, the unit issues the message *DEFIB PAD SHORT*.

An *ECG LEAD OFF* condition prevents synchronized discharge if leads are selected as the ECG source. This condition does not prevent the use of the defibrillator; it simply prevents use in a synchronized manner.

If paddles are being used for synchronized cardioversion, refer to “Emergency Defibrillation Procedure with Paddles” on page 4-1 for preparing paddles, applying paddles, charging the defibrillator, and delivering a shock. Note, however, that synchronized discharge with paddles as an ECG source is discouraged since the artifact induced by moving the paddles may resemble an R-wave and trigger defibrillator discharge at the wrong time.

### 1 Select ON



The unit beeps 4 times to indicate that it has passed the power on self test, and the green AED label and the ON mode selector light up on the front panel.

Press the **Manual Mode** softkey on the front panel of the unit to enter the Manual mode of operation.

The message *CONFIRM MANUAL MODE* and the **Confirm** softkey will be displayed. Press the **Confirm** softkey to enter the Manual mode of operation. If the **Confirm** softkey is not pressed within 10 seconds, the unit will revert back to AED operation.

**Note:** If the unit has been configured not to confirm the transition from AED mode to Manual mode, the unit will immediately enter Manual mode.

The control buttons for Manual mode light up on the front panel. Select the desired energy using the up and down arrow keys on the front panel (or sternum paddle if using paddles).

#### Press the Sync On/Off softkey

Your system will be in Sync mode once you press the **Sync On/Off** softkey if your R Series is not configured to support Remote Sync. However, if your R Series is configured to support

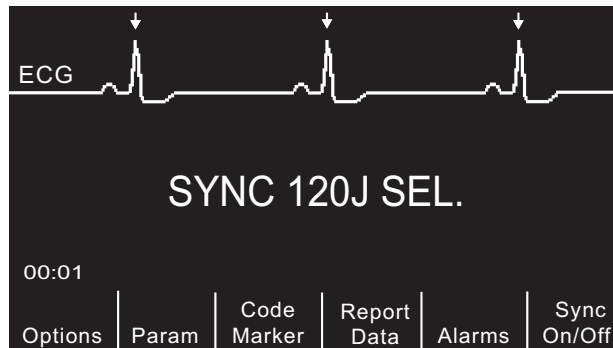
Remote Sync, pressing the **Sync On/Off** softkey will cause two other softkeys to be displayed: **Remote Sync** and **Sync**. Press the **Sync** softkey to enter Sync mode.

The selected energy level is displayed on the monitor.

A Sync marker (↓) appears on the monitor above each detected R-wave to indicate where discharge will occur.

Verify that the markers are clearly visible on the monitor and their location is appropriate and consistent from beat to beat. If necessary, use the **LEAD** and **SIZE** buttons to establish settings that yield the best display.

A *SYNC XXXJ SEL.* message appears on the display. If *DEFIB XXXJ SEL.* appears, press the **Sync On/Off** softkey. (If your unit supports Remote Sync, you must also press the **Sync** softkey.) Two quick beeps sound.



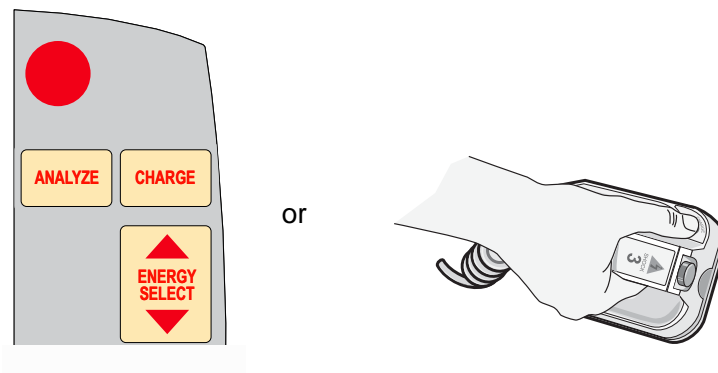
Unless otherwise configured, the unit automatically exits Sync mode after each shock and when the Mode Selector is moved to **PACER** or **OFF**.

To reactivate Sync mode, press the **Sync On/Off** softkey again. (If your unit supports Remote Sync, press the **Sync** softkey again.) Changing the selected energy levels does not cause the unit to leave Sync mode.

Note that the unit can be configured to stay in Sync mode after defibrillation, if desired. Refer to the *R Series Configuration Guide* for instructions.

## 2 Charge Defibrillator

Press the **CHARGE** button on the front panel or on the apex paddle handle.



To abort charging and increase or decrease the selected energy after the **CHARGE** button has been pressed, use the **ENERGY SELECT** buttons on either the defibrillator front panel or the

sternum paddle. Press the **CHARGE** button again to charge the unit to the newly selected energy level.

After charging the unit to the selected energy, either the front panel **SHOCK** button or the APEX paddle charge indicator illuminates. A distinctive audible tone sounds and the *SYNC XXXJ READY* message is displayed.

The defibrillator is now ready to deliver therapy.

### 3 Deliver SHOCK

---

**WARNING!** Warn all persons in attendance of the patient to **STAND CLEAR** prior to defibrillator discharge.

**Verify that no one is in contact with the patient, monitoring cable or leads, bed rails, or any other potential current pathways.**

---

Verify that the ECG waveform is stable and that Sync markers appear over each R-wave.

Press and hold the illuminated **SHOCK** button on the front panel, (or simultaneously press and hold both paddle **SHOCK** buttons) until energy is delivered to the patient. The defibrillator will discharge with the next detected R wave.

**Note:** If the defibrillator is not discharged within 60 or 120 seconds (user configurable) after reaching the selected energy level, the unit automatically disarms itself. During the ten seconds prior to this internal disarm, the charge ready tone beeps intermittently. The charge ready tone then stops, and the defibrillator remains in Sync mode.

Once the energy is delivered, the display simultaneously shows *XXXJ DELIVERED* and *DEFIB XXXJ SEL*. After approximately 5 seconds, the *XXXJ DELIVERED* message disappears and the *DEFIB XXXJ SEL* message remains to indicate the selected energy level.

If additional countershocks are necessary, readjust the energy level as necessary, press the **Sync On/Off** softkey, followed by the **Sync** softkey (if your unit supports Remote Sync), and repeat. Note that *SYNC XXXJ SEL* must be displayed prior to pressing the **CHARGE** button.

If the **ANALYZE** button is pressed while the unit is in Sync mode, the unit displays the *REMOVE SYNC* message and does not allow ECG rhythm analysis until the unit is taken out of Sync mode.

## Remote Synchronized Cardioversion Procedure

The R Series may be configured to receive defibrillation synchronization pulses from a remote ECG monitoring device. See the *R Series Configuration Manual*. Be sure that the remote device is connected to the Sync In/Marker Out connector on the R Series unit. The remote device must have a Sync out connector and a cable must be provided to connect the two devices. Ensure the remote device conforms with the Sync In/Marker Out specifications (described in Appendix A, “Defibrillator Specifications”).

**WARNING!** A lethal arrhythmia may be induced through improper synchronization. Qualified personnel within the hospital should verify synchronization delay for the entire remote

---

**monitor and defibrillator system prior to clinical use. Synchronization delay for the system as a whole must not exceed 60 msec.**

---

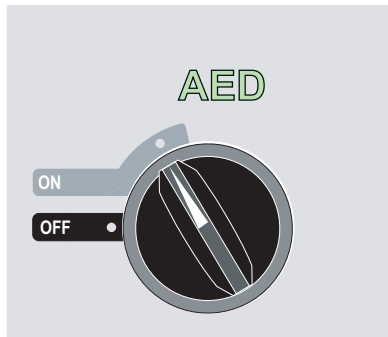
## Determine the Patient's Condition and Provide Care Following Local Medical Protocols

### Prepare Patient

Prepare the patient as described in "Prepare Patient" on page 6-2.

Follow the instructions provided with the external monitoring device to prepare the patient for ECG monitoring and synchronization with a separate defibrillator.

### 1 Select ON



The unit beeps 4 times to indicate that it has passed the power on self test and the green AED label and the ON mode selector light up on the front panel.

Press the **Manual Mode** softkey on the front panel of the unit to enter the Manual mode of operation.

The message *CONFIRM MANUAL MODE* and the **Confirm** softkey will be displayed. Press the **Confirm** softkey to enter the Manual mode of operation. If the **Confirm** softkey is not pressed within 10 seconds, the unit will revert back to AED operation.

**Note:** If the unit has been configured not to confirm the transition from AED mode to Manual mode, the unit will immediately enter Manual mode.

The control buttons for Manual mode light up on the front panel. Select the desired energy using the up and down arrow keys on the front panel (or sternum paddle if using paddles).

#### **Press Sync On/Off softkey, then press the Remote Sync Softkey**

The selected energy level is displayed on the monitor.

The words "REMOTE SYNC" are displayed in place of the ECG trace, and a *REMOTE SYNC XXXJ SEL.* message appears on the display.

The ECG heartbeat indicator will flash with each synchronization pulse received from the remote monitoring device.

Unless otherwise configured, the unit automatically exits Sync mode after each shock, and if the Mode Selector is moved to **OFF**.

Press the **Sync On/Off, Remote Sync** softkey sequence again to reactivate Remote Sync mode. Changing the selected energy levels does not cause the unit to leave Remote Sync mode.

View the ECG trace on the remote device's display. Verify that Sync markers appear with each R-wave. The Sync markers will appear as described in the remote device's user manual.

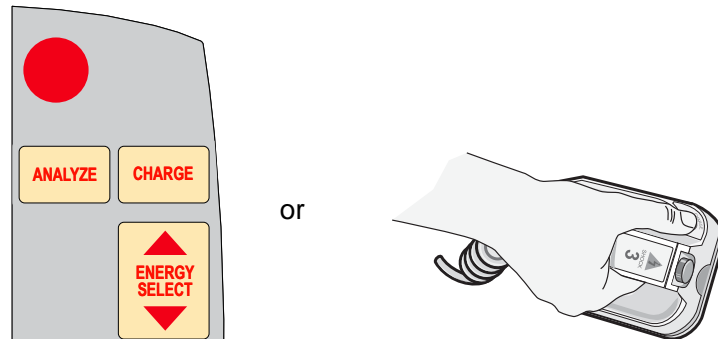
---

**WARNING!** Verify the ECG waveform is stable and that a Sync marker appears only with R-waves. If Sync markers are not present on the remote device display, or do not appear to be nearly simultaneous with each R-wave, do not proceed with synchronized cardioversion.

---

## 2 Charge Defibrillator

Press the **CHARGE** button on the front panel or, if using paddles, on the apex paddle handle.



To abort charging and increase or decrease the selected energy after the **CHARGE** button has been pressed, use the **ENERGY SELECT** buttons on either the defibrillator front panel or the sternum paddle. Press the **CHARGE** button again to charge the unit.

After charging the unit to the selected energy, either the front panel **SHOCK** button or, the apex paddle charge indicator illuminates. A distinctive audible tone sounds and the energy ready *REMOTE SYNC XXXJ READY* message is displayed.

The defibrillator is now ready to deliver therapy.

## 3 Deliver SHOCK

---

**WARNING!** Warn all persons in attendance of the patient to **STAND CLEAR** prior to defibrillator discharge.

Verify that no one is in contact with the patient, monitoring cable or leads, bed rails, or any other potential current pathways.

---

Press and hold the illuminated **SHOCK** button on the front panel, or simultaneously press and hold both paddle **SHOCK** buttons until energy is delivered. The defibrillator will discharge with the next remote synchronization pulse.

**Note:** If the defibrillator is not discharged within 60 or 120 seconds (user configurable) after reaching the selected energy level, the unit automatically disarms itself. During the ten seconds prior to this internal disarm, the charge ready tone beeps intermittently. The charge ready tone then stops and the defibrillator remains in Remote Sync mode.

Once the energy is delivered, the display simultaneously shows *XXXJ DELIVERED* and *DEFIB XXXJ SEL*. After approximately 5 seconds, the *XXXJ DELIVERED* message disappears and the *DEFIB XXXJ SEL* message remains to indicate the selected energy level.

If additional countershocks are necessary, readjust the energy level as necessary, press the **Sync On/Off**, and then the **Remote Sync** softkeys and repeat. Note that *REMOTE SYNC XXXJ SEL* must be displayed prior to pressing the **CHARGE** button.

If the **ANALYZE** button is pressed while the unit is in Remote Sync mode, the unit displays the *REMOVE SYNC* message and disallows ECG rhythm analysis until the unit is taken out of Sync mode.

# Chapter 7

## Real CPR Help

---



Real CPR Help is defibrillation-proof Type BF equipment.

---

**WARNING!** The Real CPR Help function is fully functional *only* when using adult CPR electrodes. Do *not* use Adult CPR electrodes with patients under 8 years of age.

---

---

**WARNING!** Use *only* Pediatric CPR electrodes with patients under 8 years of age. The use of Pediatric CPR electrodes enables the R Series unit to display Idle Time and Compression Rate and Depth measurements. Pediatric CPR electrodes do *not* enable Real CPR voice prompts or any visual indication of ineffective CPR.

---

When used with OneStep CPR electrodes or OneStep Complete electrodes, the R Series unit can provide rescuers with feedback about the quality of CPR they are delivering to their patients. The way in which feedback is provided varies with respect to the operational mode and user configuration, but is derived from compression rate and depth measurements.

When applied according to package instructions, ZOLL OneStep CPR and OneStep Complete electrodes provide a chest compression sensor that is located between the rescuer's hands and the patient's lower sternum. This sensor monitors the rate and depth of chest compressions and sends this information to the R Series unit for processing and display.

The R Series defibrillator uses this information to provide feedback to the rescuer in one or more of the following forms:

- Perfusion Performance Indicator (R Series Plus Only)

- CPR Idle Time Display
- CPR Rate Metronome
- Voice prompts
- Chest Compressions Waveform display
- *FULLY RELEASE* display prompt (if configured)

## Real CPR Help Field

Whenever OneStep CPR, or OneStep Complete electrodes are connected to the R Series defibrillator, the unit illuminates the Real CPR Help field in the upper center portion of the display. This field includes the indicators described in the next sections.

### Perfusion Performance Indicator (R Series Plus/Adult Only)

This feature is only available in R Series Plus models. This diamond shaped figure provides a quick, overall indicator of how well the rescuer's combined rate and depth of chest compressions match the AHA/ERC recommendations for adult CPR.

Before chest compressions begin (and after each shock), the Perfusion Performance Indicator is displayed as a hollow outline. This index starts to fill from the center out as compressions begin, and becomes fully filled when consistent chest compression depth exceeding 1.5 or 2 inches (depending on the configuration) and rate exceeding 100 compressions per minute (cpm) are simultaneously achieved. Should the chest compression rate or depth begin to fall below the AHA/ERC recommended levels, the PPI will only partially fill to indicate the need for more vigorous efforts. Following the cessation of compressions, the PPI's fill level gradually decreases until a hollow outline is displayed after a short period of time.

When complete filling of the Perfusion Performance Indicator has not been achieved due to diminished compression rate or depth, and the CPR Dashboard is configured Off, the R Series will display the words RATE and/or DEPTH to assist the rescuer in determining whether chest compression rate or depth should be increased. When an appropriate rate or depth has been achieved, 100 cpm and 1.5 or 2 inches, respectively, one or both of these words will disappear from the display.

This feature is unavailable while using Pediatric CPR electrodes.

### CPR Idle Time Display

This display indicates the elapsed time in minutes and seconds since the last detected chest compression. When compressions are being delivered, this time display will be blanked. Three seconds following the cessation of compressions, the display will illuminate and show the elapsed time since the last detected compression. If no compressions have been delivered for more than 20 minutes, dashes (---) will be displayed in this time field.

### CPR Rate and Depth Display

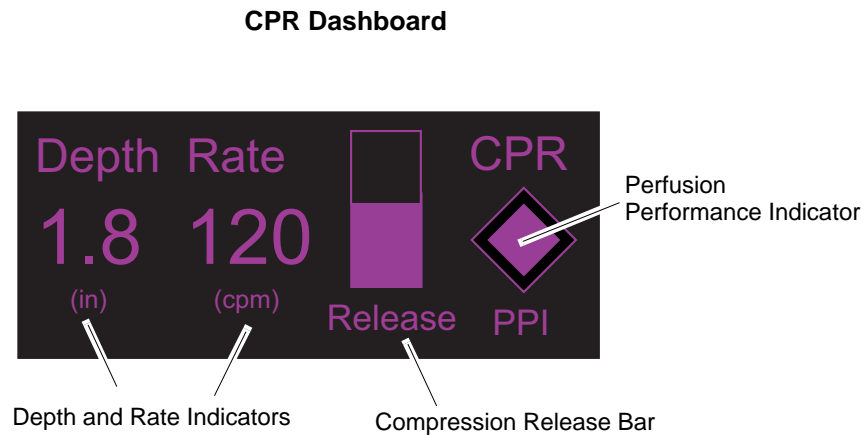
If the CPR Dashboard is configured On and the CPR Idle Time is not displayed, the Rate and Depth values are displayed in the default color; the same values are highlighted and change color if they are not within the AHA-recommended range of below 100 or over 120 compressions per minute. This feature is unavailable while using Pediatric CPR electrodes.



## Compression Release Bar (R Series Plus/Adult only)

If the CPR Dashboard is configured On, the Compression Release Bar shows the release of the chest compression by the rescuer. When the release of the chest is properly administered (quickly and completely released), the bar will fill all the way to the top.

This feature is unavailable while using Pediatric CPR electrodes.



## CPR Metronome

The R Series unit includes a CPR metronome feature that can be used to encourage rescuers to perform chest compressions at the AHA/ERC recommended rate of 100 - 120 compressions per minute. This feature can be configured.

When activated, the metronome beeps at the AHA/ERC recommended rate to provide a compression rhythm for rescuers to follow. The metronome is silent when no chest compressions are being detected by CPR-equipped hands-free therapy electrodes.

In AED mode, CPR voice prompts and metronome are always on during the time that clinical protocol instructs the user to perform CPR.

When Manual and Advisory modes are configured to “Yes,” the metronome only beeps when chest compressions are detected and their rate falls below the AHA/ERC recommended levels. When compressions are being performed at 100 compressions per minute or higher, the metronome is silent. Should the detected compression rate fall below this level, the metronome will begin beeping until recommended compression rates are consistently achieved over several compression cycles. The metronome stops beeping approximately 2 seconds after the last chest compression is detected.

When Manual and Advisory modes are configured to “Continuous,” the metronome beeps as long as compressions are detected, even when they are being performed at 100 compressions per minute or higher. The metronome stops beeping approximately 2 seconds after the last chest compression is detected.

## Fully Release prompt

The R Series unit can be configured to display the text prompt FULLY RELEASE, which reminds rescuers to lift (fully release) their hands from the patient's chest during compressions to allow full recoil.

This feature is unavailable while using Pediatric CPR electrodes.

By default, the FULLY RELEASE text prompt is not enabled.

## CPR Voice Prompts (R Series Plus/Adult only)

The R Series can be configured to issue voice prompts related to the depth of chest compressions as feedback to rescuers performing CPR. Two voice prompts are available for this purpose:

- Push Harder
- Good Compressions

When chest compressions are detected but their depth is consistently less than 1.5 or 2 inches (3.8 or 5 cm), depending on the configuration, the defibrillator will periodically issue the prompt “Push Harder” every 15 seconds. If the rescuer responds by increasing compression depth to more than 1.5 or 2 inches (3.8 or 5 cm), depending on the configuration, on a consistent basis, the unit will issue a “Good Compressions” prompt.

See the *R Series Configuration Guide* for information on enabling/disabling CPR voice prompts.

CPR Voice prompts are unavailable while using Pediatric CPR electrodes.

## Chest Compressions Bar Graph (Manual Mode Only)

The R Series unit can display a CPR compression bar graph computed from the CPR sensor signals. This bar graph, representing depth of compression, is presented on a displacement scale with a reference marker at 1.5 or 2.0 inches, depending on the configuration. When the full width of the trace is visible, the unit displays a minimum of 12 seconds of compression data.

## Displaying the CPR Bar Graph (Manual Mode Only)

To display the CPR bar graph in the Trace 2 or 3 position:

1. Press the **Options** softkey, then press **Traces**.
2. Press either the **Trace 2** or **Trace 3** softkey.
3. Press **CPR**.

**Note:** The **CPR** softkey appears only when OneStep CPR or OneStep Complete electrodes are in use.

# Chapter 8

## See-Thru CPR (R Series Plus Only)

---

The See-Thru CPR feature is only available in R Series Plus models.

---

**WARNING!** The See-Thru CPR filter works only when the R Series defibrillator is monitoring CPR in Manual mode.

**The See-Thru CPR filter stops if:**

- The unit is in pace mode.
- Patient impedance is invalid.
- OneStep CPR electrodes or OneStep Complete electrodes are no longer detected.

**The See-Thru CPR filter will not remove all CPR artifact. Always stop CPR to verify the patient's ECG rhythm before making treatment decisions.**

**The See-Thru CPR filter does not operate during ECG rhythm analysis. Always stop chest compressions during ECG rhythm analysis to avoid incorrect results caused by the presence of CPR artifact.**

**Diagnostic bandwidth is never applied to the See-Thru CPR waveform.**

---

See-Thru CPR enables the rescuer to see a close approximation of the patient's underlying ECG rhythm while performing CPR. See-Thru CPR is available if the R Series is monitoring CPR.

Chest compressions introduce *CPR artifact* into the ECG signal. See-Thru CPR uses a filter that relies on the correlation between CPR compressions, as detected by the ZOLL Onestep CPR or OneStep Complete electrodes, and the CPR artifact to remove much, but not all, of the artifact from the ECG signal. Under some conditions, residual noise after filtering can obscure the ECG rhythm, requiring the rescuer to stop CPR to assess the ECG. For example, in the case

of asystole or low amplitude PEA, the residual artifact seen after filtering may look like fine ventricular fibrillation.

Because the filtered ECG signal may contain residual chest compression and/or filtering artifacts, *a rescuer should always follow the standard procedure of stopping CPR to assess the patient's ECG rhythm before determining treatment.*

## Using See-Thru CPR (R Series Plus Only)

To use See-Thru CPR

- The R Series unit must be monitoring CPR.
- OneStep CPR or OneStep Complete electrodes must be attached to the unit.

When chest compressions begin, the R Series unit *automatically* starts filtering the CPR artifact after detecting the first 3 to 6 compressions.

The filtered ECG, with the label “FIL,” may be displayed on the second or third trace (by selecting FILT ECG in the Trace2 or Trace3 menu). See-Thru CPR filtering continues as long as the OneStep CPR or OneStep Complete electrodes detect compressions and patient impedance is valid. When no compressions are detected or one of the conditions noted above occurs, See-Thru CPR filtering stops, and unfiltered ECG signals are displayed. When compressions resume, filtering automatically restarts after 3 to 6 chest compressions.

**Note:** There is a delay of approximately 1/16 second between the See-Thru CPR waveform and the Trace 1 ECG waveform.

If configured to display the CPR Dashboard, the R Series unit can also be configured to display the filtered ECG in Trace1. When the unit is configured to display the filtered ECG in Trace1, the softkey **Disable Filt ECG** appears, which you can press to disable display of the filtered ECG in Trace1 and replace it with the unfiltered ECG. When the unit displays the unfiltered ECG in Trace1, the softkey **Enable Filt ECG** appears, which can redisplay the filtered ECG in Trace1.

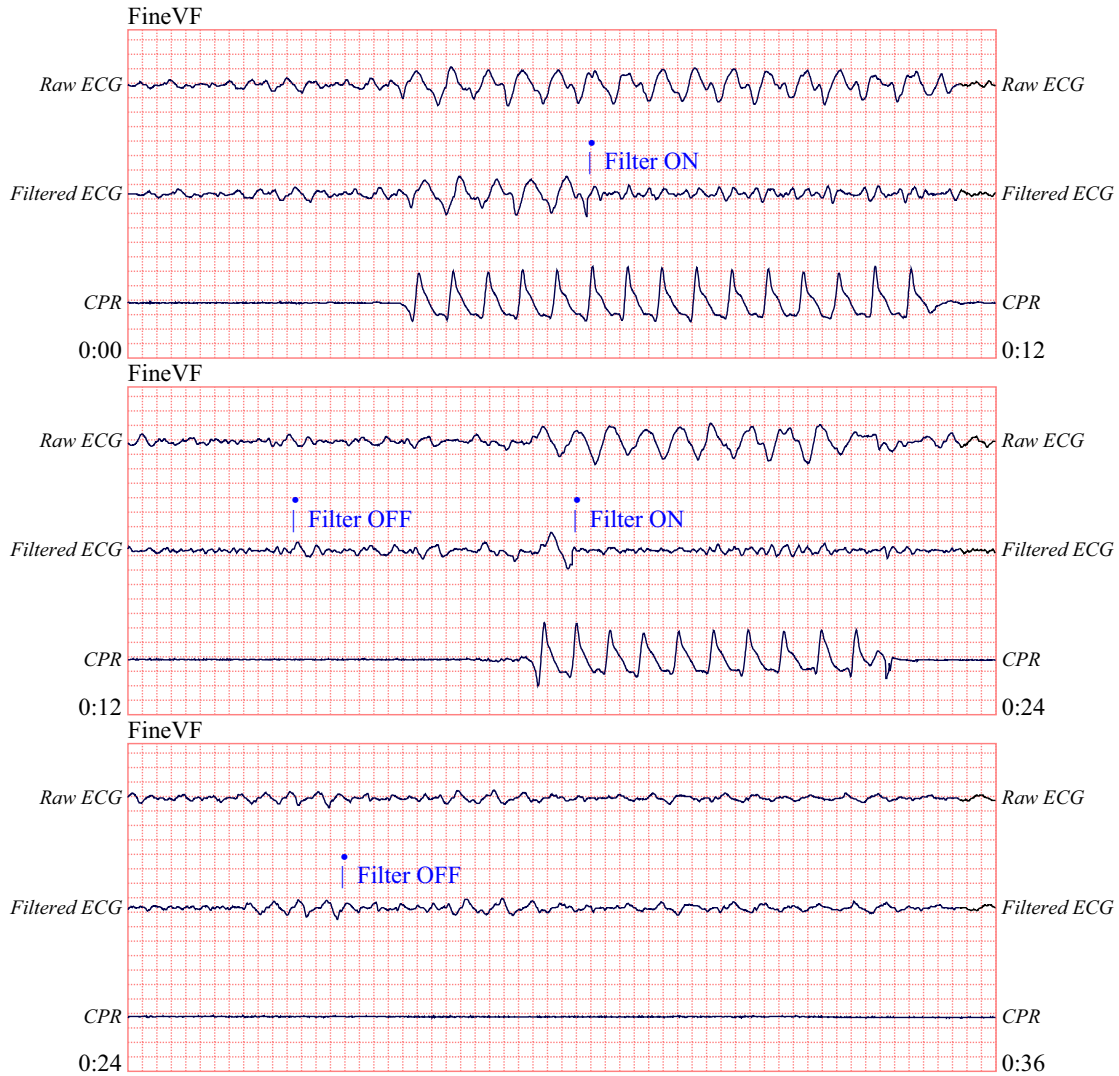
## Examples

The following examples show the effects of See-Thru CPR filtering on ECG signals contaminated with CPR artifacts.

Each example includes:

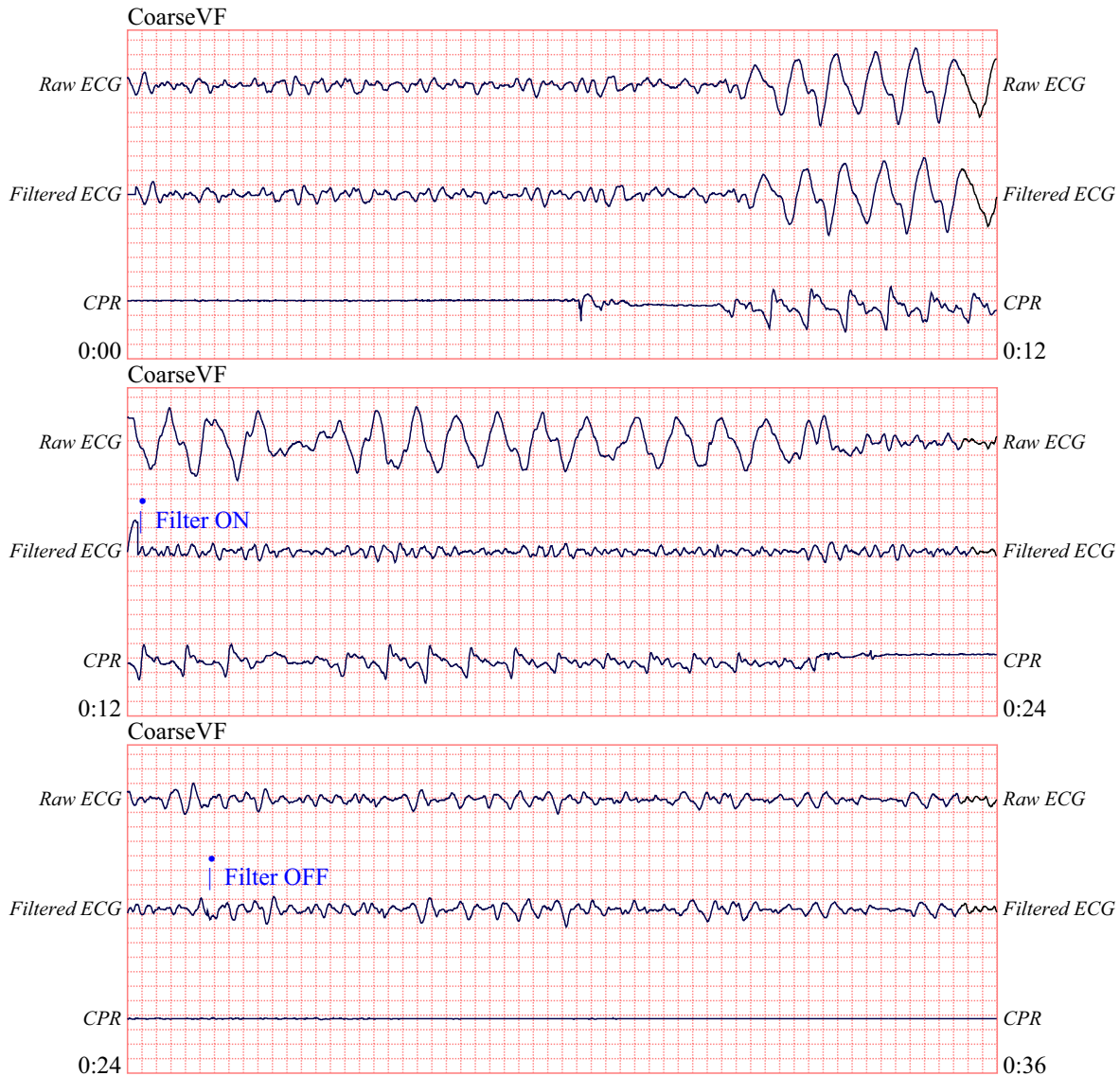
- ECG signal with CPR artifact.
- ECG signal after the See-Thru CPR filter has removed CPR artifact.
- Indication of the period during which See-Thru CPR is active.
- CPR signal to show when CPR activity occurred.

The following figure shows a patient in Fine VF. It is difficult for a rescuer to discern this rhythm during CPR compressions. When the CPR filter turns on, the Fine VF rhythm becomes more obvious.



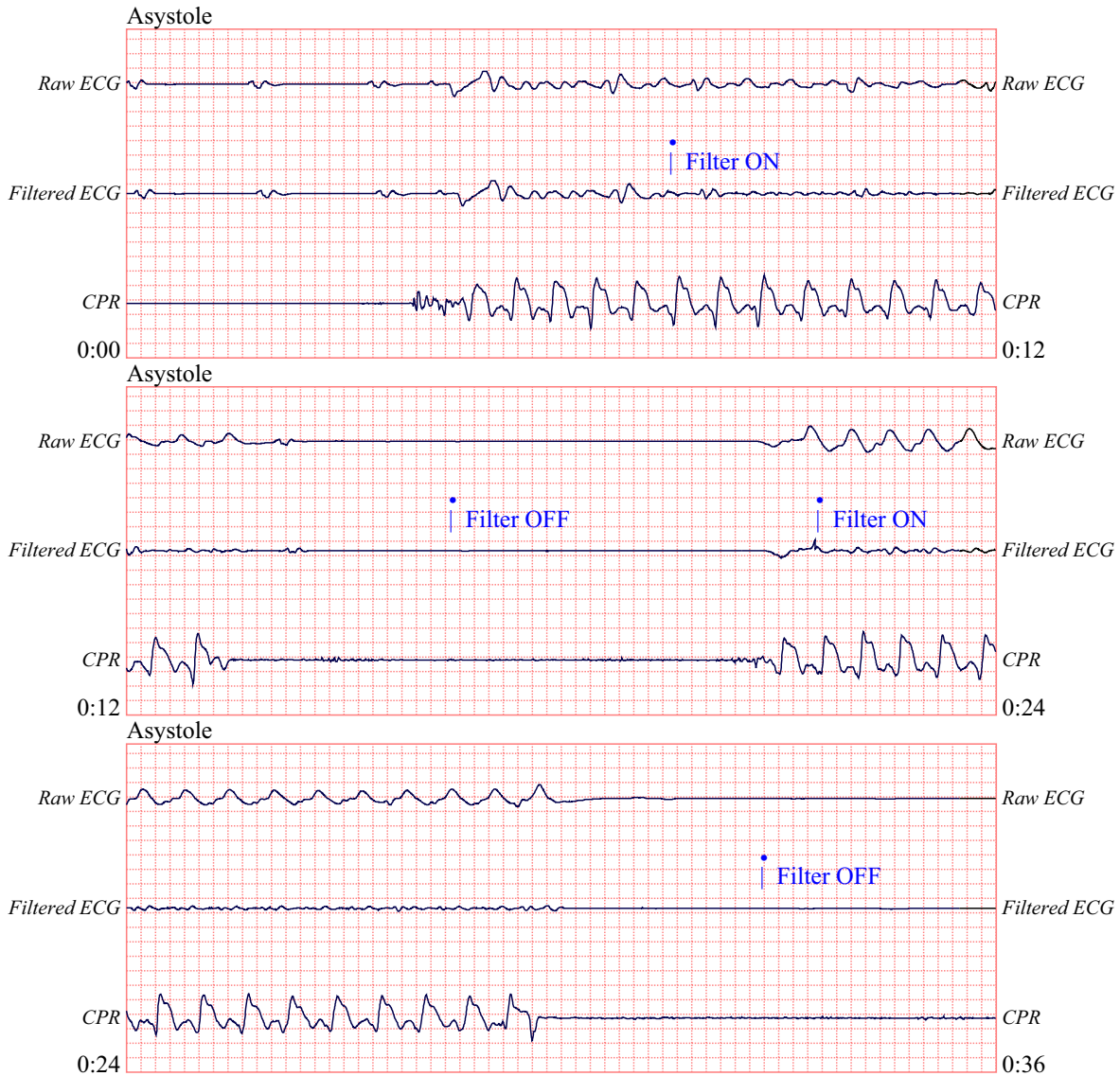
12.5 mm/sec, 5 mm/mV

The following figure shows a patient in VF, which, during compressions, is slightly more difficult to discern. When viewing this ECG, it is possible to view the underlying rhythm as the filter is able to reject all of the CPR artifact.



12.5 mm/sec, 5 mm/mV

The following figure shows a patient in PEA, which could easily be mistaken for Fine VF because enough of the compression artifact leaks through to distort this signal. When the CPR filter turns on, the PEA is still not obvious because of the left over ripples from the CPR signal. About 14 seconds into this chart, the rhythm changes to asystole, which could easily be mistaken for coarse VF. When the CPR filter turns on, the CPR compression ripples are still obvious, making the rhythm look like Fine VF.



12.5 mm/sec, 5 mm/mV

The following figure shows a patient with an organized rhythm where See-Thru CPR effectively filters out artifact created by CPR.



12.5 mm/sec, 5 mm/mV



# Chapter 9

## Noninvasive Temporary Pacing (Optional)

---

**Note:** This is an optional feature and is only available in Manual mode.



When ZOLL hands-free therapy electrodes are used, the patient connection is considered to be defibrillation-protected Type BF.



ECG leads are a defibrillation-protected Type CF patient connection.

---

**WARNING!** To avoid risk of electrical shock, do not touch the gelled area of the hands-free therapy electrodes while pacing.

Therapy electrodes should be replaced periodically. Consult electrode directions for specific recommendations.

Prolonged pacing (in excess of 30 minutes), particularly in neonates or adults with severely restricted blood flow, may cause burns. Periodic inspection of the underlying skin is recommended.

If the unit was NOT turned off and less than 10 minutes have elapsed since the pacing mode was last used, reactivating the pacer mode causes pacing to resume immediately at the previously selected mA and ppm settings.

---

## Noninvasive Temporary Pacing

R Series defibrillators with the pacer option contain a VVI demand pacemaker – a safe and effective design for Noninvasive Temporary Pacemakers.

Proper demand pacing requires a reliable, high quality surface ECG signal. For best results:

- Apply both standard ECG monitoring electrodes and hands-free pacing therapy electrodes (such as, OneStep electrodes or Stat-padz) to the patient,  
or
- Use OneStep Pacing electrodes, or OneStep Complete electrodes. These hands-free therapy pads include both ECG monitoring and pacing/defibrillation electrodes in a single pad assembly. They provide reliable ECG monitoring without the need to use separate ECG leads. With these electrodes you must also use the OneStep Pacing cable.

### Determine Patient Condition and Provide Care Following Local Medical Protocols.

#### Prepare the Patient

Remove all clothing covering the patient's chest. Dry chest if necessary. If the patient has excessive chest hair, clip it to ensure proper adhesion of the electrodes.

#### 1 Apply ECG Electrodes/Hands-Free Therapy Electrodes

The R Series supports two electrode configurations for pacing:

- **OneStep Pacing Configuration**

Simultaneous ECG monitoring and pacing can be performed with a single set of therapy electrodes when using OneStep Pacing electrodes or OneStep Complete electrodes along with a OneStep Pacing cable. The OneStep Pacing cable must be connected to both the MFC and ECG connectors of the R Series unit. Attach OneStep electrodes according to instructions on the electrode packaging. Then connect the electrodes to the OneStep Pacing cable.

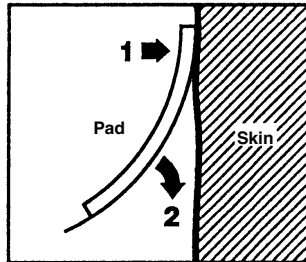
- **Separate ECG Electrodes and Hands-free Therapy Electrodes Configuration**

Apply ECG electrodes, attach lead wires, and connect the ECG cable to the R Series rear panel (see page 10-3 for instructions on attaching ECG electrodes to the patient). Attach hands-free therapy electrodes according to instructions on the electrode packaging. Connect these therapy electrodes to the OneStep cable.

## Therapy Electrode Application

**WARNING!** Poor adherence and/or air under the therapy electrodes can lead to the possibility of arcing and skin burns.

1. Apply one edge of the pad securely to the patient.
2. Roll the pad smoothly from the applied edge to the other, being careful not to trap any air pockets between the gel and skin.

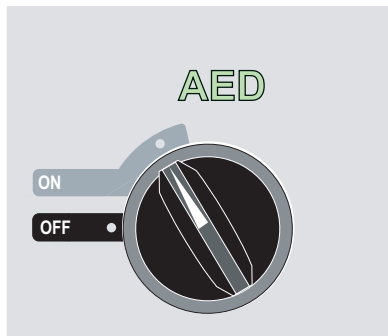


3. Ensure that hands-free therapy electrodes are making good contact with the patient's skin and are not covering any part of any other ECG electrodes.
4. If using OneStep Pacing electrodes or OneStep Complete electrodes, select ECG lead P1, P2, or P3; otherwise, select an appropriate ECG lead. Adjust ECG size for a clean, well-defined ECG signal.
5. Verify proper R-wave detection. The heart-shaped symbol flashes with each R-wave when proper detection is taking place. Adjust ECG size for a clean, well-defined ECG signal.

**Note:** When the OneStep Pacing electrode configuration is used and the unit is switched to **PACER** mode, P3 is automatically selected as the ECG source. When separate ECG electrodes and hands-free therapy electrodes are used, Lead II is automatically selected as the ECG source.

While ECG signals acquired from P1, P2 or P3 are appropriate for ECG rhythm assessment and determining electrical capture during pacing, they should not be used for diagnostic purposes. Conventional ECG electrodes and cable should be used for this purpose.

### 1 Select ON



The unit beeps 4 times to indicate that it has passed the power on self test, and the green AED label and the ON mode selector light up on the front panel.

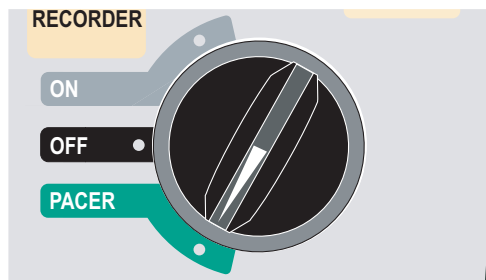
Press the **Manual Mode** softkey on the front panel of the unit to enter the Manual mode of operation.

The message *CONFIRM MANUAL MODE* and the **Confirm** softkey will be displayed. Press the **Confirm** softkey to enter the Manual mode of operation. If the **Confirm** softkey is not pressed within 10 seconds, the unit will revert back to semiautomatic operation.

**Note:** If the unit has been configured not to confirm the transition from AED mode to Manual mode, the unit will immediately enter Manual mode.

The control buttons for Manual mode light up on the front panel.

## 2 Turn Mode Selector to PACER



The pacer door drops open and the knobs are displayed.

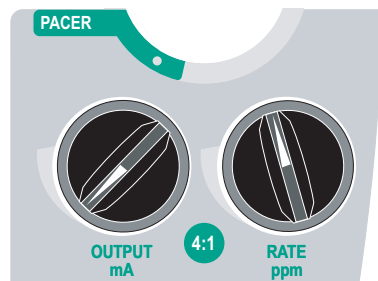
### Set the Pacer Output to 0 mA

If the unit has just been turned on, the **PACER OUTPUT** is automatically set to 0 mA.

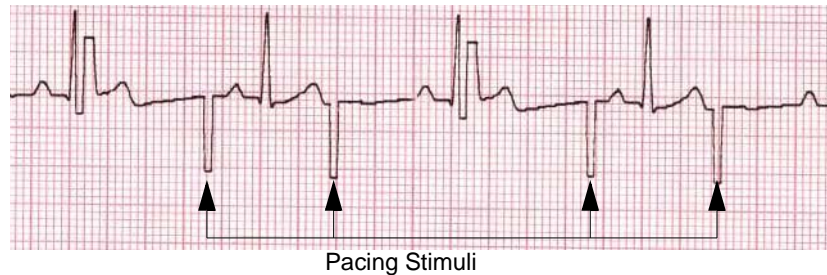
## 3 Set Pacer Rate

Set the **PACER RATE** to a value 10-20 ppm higher than the patient's intrinsic heart rate. If no intrinsic rate exists, use 100 ppm.

The pacer rate increments or decrements by a value of 2 ppm on the display when the knob is turned.

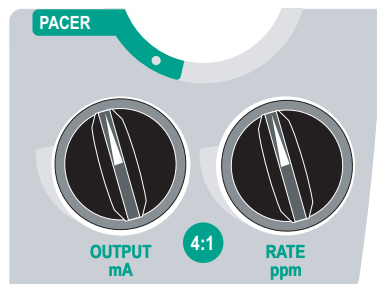


Observe the pacing stimulus marker on the display or stripchart (  $\square$  ) and verify that it is well-positioned in diastole.



## 4 Set Pacer Output

Increase **PACER OUTPUT** until stimulation is effective (capture); the output mA value is displayed. The pacer output increments and decrements by a value of 2 mA on the display when the knob is turned.



**Note:** When the unit is switched out of PACER mode into Manual mode and then switched back to PACER mode, within 10 minutes the pacer settings remain unchanged.

If the unit is turned off for more than 10 seconds, the pacer's power up default settings are restored.

## 5 Determine Capture

It is important to recognize when pacing stimulation has produced a ventricular response (capture). Determination of capture must be assessed both electrically and mechanically in order to ensure appropriate circulatory support of the patient.

Electrical capture is determined by the presence of a widened QRS complex, the loss of any underlying intrinsic rhythm, and the appearance of an extended, and sometimes enlarged, T-wave.

Ventricular response is normally characterized by suppression of the intrinsic QRS complex.

---

**WARNING!** Determination of electrical capture should only be performed by viewing the ECG trace on the R Series display with its ECG connection directly attached to the patient. Use of other ECG monitoring devices might provide misleading information due to the presence of pacer artifacts.

---

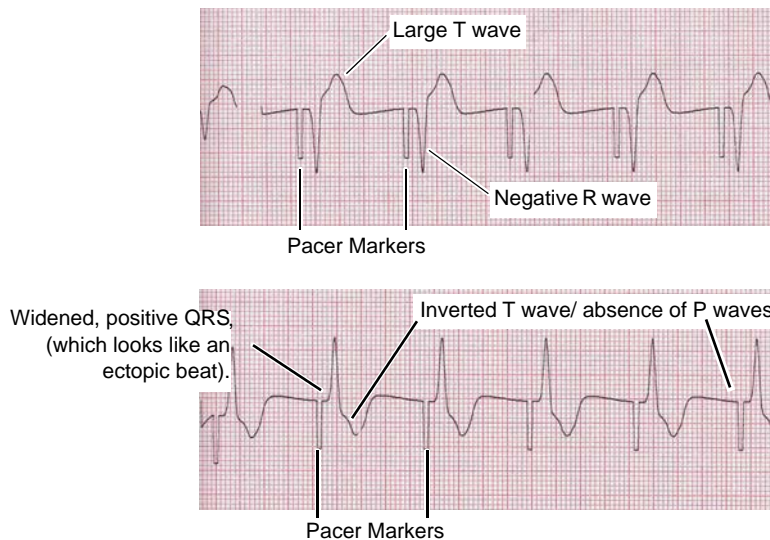
Mechanical capture is assessed by palpation of the peripheral pulse.

To avoid mistaking muscular response to pacing stimuli for arterial pulsations, use **ONLY** the following locations for palpating pulse during pacing:

- femoral artery
- right brachial or radial artery

### Effective pacing

The following ECG traces illustrate typical examples of effective pacing.



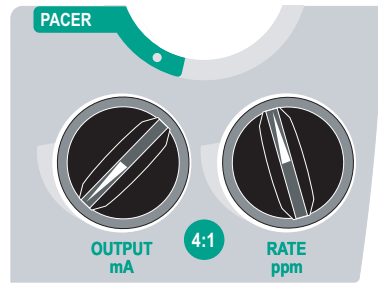
Changing ECG leads and size can sometimes be helpful in determining capture.

**Note:** The shape and size of the paced ECG waveforms can vary depending on the ECG lead configuration chosen; variation from patient to patient can be expected.

## 6 Determine Optimum Threshold

The ideal pacer current is the lowest value that maintains capture — usually about 10% above threshold. Typical threshold currents range from 40 to 80 mA. Location of the hands-free therapy or OneStep therapy electrodes affects the current required to obtain ventricular capture. Typically the lowest threshold is obtained when the position of the electrodes provides the most direct current pathway through the heart while avoiding large chest muscles. Lower stimulation currents produce less skeletal muscle contraction and are better tolerated.

### 4:1 Mode



Pressing and holding the 4:1 button temporarily withholds pacing stimuli, thereby allowing you to observe the patient’s underlying ECG rhythm and morphology.

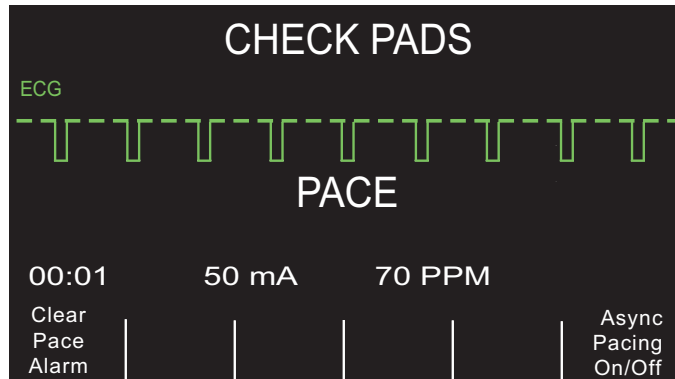
When depressed, this button causes pacing stimuli to be delivered at  $\frac{1}{4}$  of the indicated ppm setting.

### Pace Fault

If the unit is attempting to deliver pacing therapy and one of the following conditions occur, the messages *CHECK PADS* and *POOR PAD CONTACT* are alternately displayed on the screen and an audible alarm sounds:

- The OneStep cable is not connected to the device.
- The cable is defective.
- Therapy pads are not connected to the OneStep cable.
- The therapy pads are not making good skin contact.

The alarm will continue to sound until proper connections between the patient and pacer are achieved and the leftmost softkey (**Clear Pace Alarm**) is pressed.



## Special Pacing Applications

Noninvasive Temporary Pacing can be performed in the Cardiac Catheterization Lab either for emergency pacing or standby pacing. For pacing in X-ray and fluoroscopic applications, ZOLL Pro-padz<sup>®</sup> radiolucent hands-free therapy electrodes may be used.

Noninvasive Temporary Pacing can be performed in the Operating Room using ZOLL Pro-padz sterile hands-free therapy electrodes.

---

**Caution** Under certain conditions, it may not be possible to properly monitor or pace while electro-surgical apparatus is operating. Interference caused by use of electro-surgical apparatus may result in a *CHECK PADS* or *LEADS OFF* message. If a *CHECK PADS* message is present, the unit will not deliver energy. Observe the device carefully for evidence of proper operation.

---

### Standby Pacing

For certain patients at risk of developing symptomatic bradycardia, it may be advisable to use the unit in standby mode. When used in standby mode, the unit automatically provides pacing stimuli whenever the patient's heart rate drops below the pacer rate setting. Patient's ECG must be monitored using one of the two electrode configurations described on page 8-2. To use the device in standby mode:

1. Establish effective pacing (see instructions on previous pages). Note the mA output at capture and run an ECG stripchart to document ECG morphology during capture.
2. Set the mA output 10% higher than the minimum mA output necessary to effect consistent ventricular capture.
3. Turn the pacing rate (ppm) below the patient's heart rate. This suppresses pacing unless the patient's own rate drops below the pacer rate setting. The pacing rate should be set at a level sufficient to ensure adequate cardiac output.
4. Check the threshold periodically.

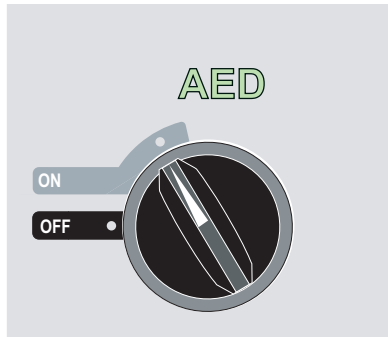
### Asynchronous Pacing

If ECG electrodes are not available or there is some circumstance that prevents or interferes with the surface ECG, the R Series delivers pacemaker pulses asynchronously.

Asynchronous pacing should be performed only in an emergency when no alternative is available. To pace asynchronously:



## 1 Select ON



The unit beeps 4 times to indicate that it has passed the power on self test, and the green AED label and the ON mode selector light up on the front panel.

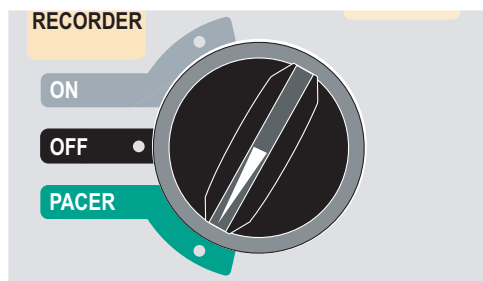
Press the **Manual Mode** softkey on the front panel of the unit to enter the Manual mode of operation.

The message *CONFIRM MANUAL MODE* and the **Confirm** softkey will be displayed. Press the **Confirm** softkey to enter the Manual mode of operation. If the **Confirm** softkey is not pressed within 10 seconds, the unit will revert back to semiautomatic operation.

**Note:** If the unit has been configured not to confirm the transition from AED mode to Manual mode, the unit will immediately enter Manual mode.

The control buttons for Manual mode light up on the front panel.

## 2 Turn Mode Selector to PACER

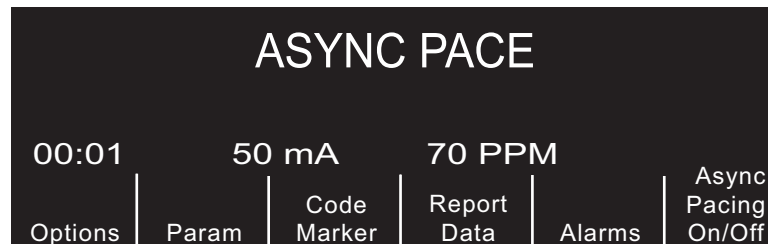


The pacer door drops open and the knobs are displayed.

## Press the Async Pacing On/Off softkey

**Note:** If the pacer output is set to 8 mA or higher, pacing stimuli begin immediately at the set rate.

The display shows “ASYNC PACE” to indicate that asynchronous pacing has been activated. The annotation “ASYNC PACE” is also printed on the stripchart when activated by the **RECORDER** button, and printed on the corresponding summary report. To return to demand pacing, press the **ASYNC Pacing On/Off** softkey again. The display returns to “PACE.”



Pace stimuli are also delivered asynchronously whenever there is an *ECG LEAD OFF* condition. Due to the lead off condition, no ECG waveforms will be displayed when pacing by this method. Use other means to determine capture such as checking the patient’s pulse.

When asynchronously pacing with an *ECG LEAD OFF* condition, the rate and mA should be set at the known capture level or high enough (100mA) to presume capture.

## Pediatric Pacing

Noninvasive pacing of pediatric patients is performed in an identical manner to adult pacing. Smaller size pediatric therapy electrodes are available for patients weighing less than 55 lbs/25 kg. Continuous pacing of neonates can cause skin burns. If it is necessary to pace for more than 30 minutes, periodic inspection of the underlying skin is strongly advised. Carefully follow all instructions on electrode packaging.

# Chapter 10

## ECG Monitoring

---

**Note:** This option is only available in Manual mode.



ECG leads are a defibrillation-protected Type CF patient connection.

The R Series products can be used for either short- or long-term ECG monitoring.

R Series products have built-in circuitry to prevent damage to their ECG monitoring circuits during defibrillation. Monitoring electrodes, however, can become polarized during defibrillator discharge, causing the ECG trace to briefly disappear from the screen. High-quality silver/silver chloride (Ag/AgCl) electrodes minimize this effect. Circuitry in the unit returns the ECG trace to the display within a few seconds.

You can monitor a patient's ECG using an ECG patient cable, hands-free therapy electrodes, or through standard defibrillation paddles.

During ECG monitoring, the R Series displays the following information:

- Five seconds of ECG waveforms
- Heart Rate
- Heartbeat indicator
- ECG source lead (I, II, III, aVR, aVL, aVF, or V with ECG cable; PADS, or PADDLES)
- ECG size relative scale factor - x0.5, x1, x1.5, x2, x3
- Alarm indicator

Whenever more than one waveform is displayed, the selected ECG lead appears as the uppermost trace (unless the unit is configured for Filtered ECG).

**Caution** ECG electrodes embedded in OneStep Pacing and Complete resuscitation pads produce non-standard ECG monitoring lead vectors, designated P1, P2 and P3. While ECG signals acquired from these leads are appropriate for ECG rhythm assessment and determining electrical capture during pacing, they should not be used for ECG morphological evaluations. Attach conventional ECG electrodes for diagnostic purposes.

**Note:** Note: Under certain clinical circumstances, the R Series heart rate counting system may respond to narrow, high-amplitude spikes in the ECG signal (e.g., 10 msec duration, 1 mV peak-to-peak amplitude) leading to miscounting of the patient's heart rate. Do not rely on heart rate meters if the ECG waveform contains narrow, high-amplitude spikes. If there is a question about the accuracy of heart rate counting, verify the patient's heart rate by taking his/her pulse.

## Preparations

Proper application and placement of electrodes is essential for high quality ECG monitoring. Good contact between the electrode and skin minimizes motion artifact and signal interference. Remove all clothing covering the patient's chest. Dry chest if necessary. If the patient has excessive chest hair, clip or shave it to ensure proper adhesion of the electrodes.

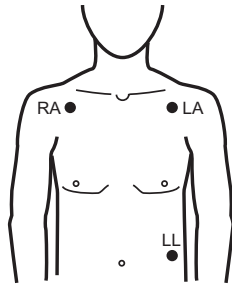
## Electrode Placement

Depending upon local usage, the ECG leads are marked either RA, LA, LL, RL, and V or R, L, F, N and C. The following table shows the markings and color codes for the different lead sets.

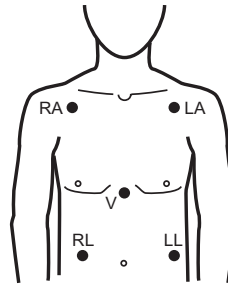
IEC Color Coding	AHA Color Coding	Placement of Electrodes
R/Red Electrode	RA/White Electrode	Place near patient's right mid-clavicular line, directly below clavicle.
L/Yellow Electrode	LA/Black Electrode	Place near patient's left mid-clavicular line, directly below clavicle.
F/Green Electrode	LL/Red Electrode	Place between 6th and 7th intercostal space on patient's left mid-clavicular line.
N/Black*	RL/Green* Electrode	Place between 6th and 7th intercostal space on patient's right mid-clavicular line.
C/White* Electrode	V/Brown* Electrode	Single movable chest electrode.

\* Not used for 3-lead monitoring

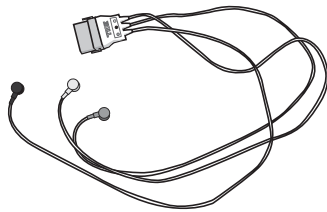
3-lead configuration



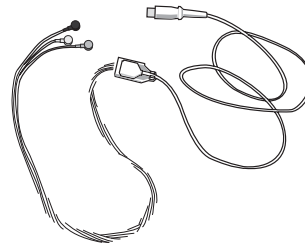
5-lead wire configuration



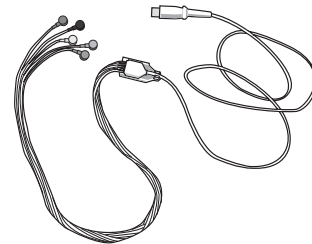
3-lead set



3-lead cable



5-lead cable



**Note:** Lead sets and lead cables are different accessories and are not interchangeable. For 5-lead monitoring, use a 5-lead cable.

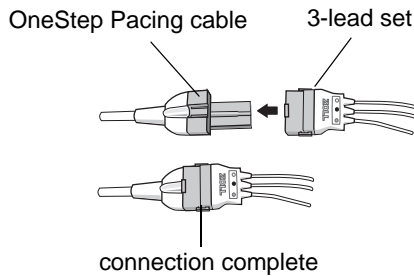
**Note:** 3-lead cables are available with and without Electro Surgical Unit noise suppression. If the R Series unit is being used in the presence of an ESU, ablation device, or any other high electromagnetic noise emitting source, ZOLL recommends using the R Series 3-Lead ECG Cable, ESU Filtered (REF 9500-000693) specifically designed to limit ESU artifact when monitoring heart rates.

## Monitoring Electrodes Attachment

Attach snap-on leads to electrodes and check for good contact between the electrode and the lead termination.

If you are using a 3-lead set, connect the end of the 3-lead set to a OneStep Pacing cable.

**Note:** The 3-lead set is a standard option with R Series Plus models.



Peel the protective backing from the ECG electrode. Be careful to keep adhesive surface free of electrolyte gel.

---

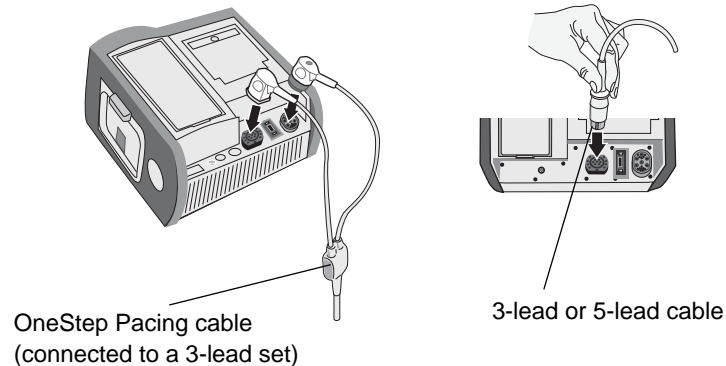
**Caution** Only use electrodes that are well within the expiration date indicated on the package.

---

Apply the ECG electrodes firmly to the patient's skin, pressing around the entire perimeter of the electrodes.

Plug the patient cable connector into the black ECG input connector (located on the rear panel of the instrument).

**Note:** If you are using a 3-lead set that is connected to a OneStep Pacing cable, plug the red connector into the red OneStep cable input connector on the device, and plug the connector (that is black inside) into the black ECG input connector on the device.



---

**Caution** To avoid electrosurgery burns at monitoring sites, ensure proper connection of the electrosurgery return circuit so that the return paths cannot be made through monitoring electrodes or probes.

---

During electrosurgery, observe the following guidelines to minimize ESU interference and provide maximum user and patient safety:

- Keep all patient monitoring cables away from earth ground, ESU knives, and ESU return wires.
- Use electrosurgical grounding pads with the largest practical contact area.

Always assure proper application of the electrosurgical return electrode to the patient.

## Monitoring the Patient's ECG

### Set the Controls

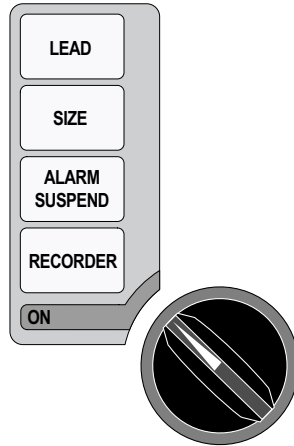
Set the Mode Selector to ON. The unit beeps 4 times to indicate that it has passed the power on self test, and the green AED label and the ON switch light up on the front panel.

Press the **Manual Mode** softkey on the front panel of the unit to enter the Manual mode of operation.

The message *CONFIRM MANUAL MODE* and the **Confirm** softkey will be displayed. Press the **Confirm** softkey to enter the Manual mode of operation. If the **Confirm** softkey is not pressed within 10 seconds, the unit will revert back to semiautomatic operation.

**Note:** If the unit has been configured not to confirm the transition from AED mode to Manual mode, the unit will immediately enter Manual mode.

The control buttons for Manual mode light up on the front panel. Press the **LEAD** button until the desired lead configuration is selected. The selected lead is indicated at upper right of the display.



If the unit displays the *ECG LEAD OFF*, *POOR LEAD CONTACT*, or *CHECK PADS* message, inspect the ECG electrodes or therapy electrodes, lead wires, and cables for proper connections.

If heart rate alarms are enabled with paddles selected, the unit displays the messages *SELECT LIMB LEADS* and *VF ALARMS OFF*. If you see these messages, select limb or precordial leads.

If you want to change the size of the displayed ECG waveform, press the **SIZE** button until the desired waveform size is displayed. Options are 0.5, 1, 1.5, 2, and 3 times the normal size.

If you want to shut off the heart rate beeper, press the **Options**, then the **QRS VOL OFF** softkeys. To turn it back on, press the **QRS VOL ON** softkey.

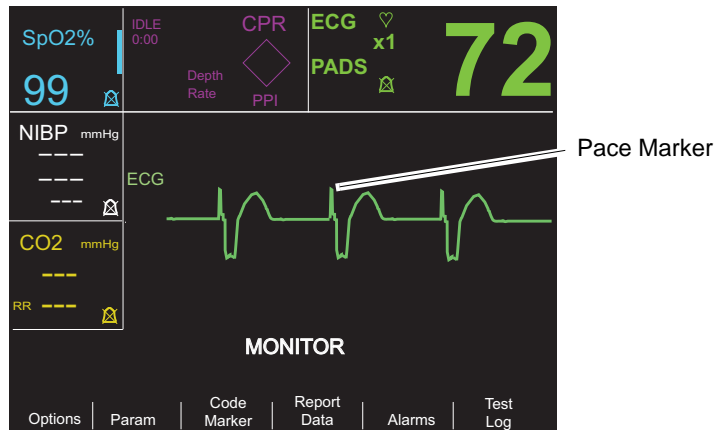
---

**WARNING!** **Implanted pacemakers may cause the heart rate meter to count pacemaker pulses during incidents of cardiac arrest or other arrhythmias. Pacemaker patients should be carefully observed. Check the patient's pulse; do not rely solely on heart rate meters. Dedicated pacemaker detection circuitry may not detect all implanted pacemaker spikes; patient history and physical exam are important in determining the presence of an implanted pacemaker.**

---


## Implanted Pacemakers

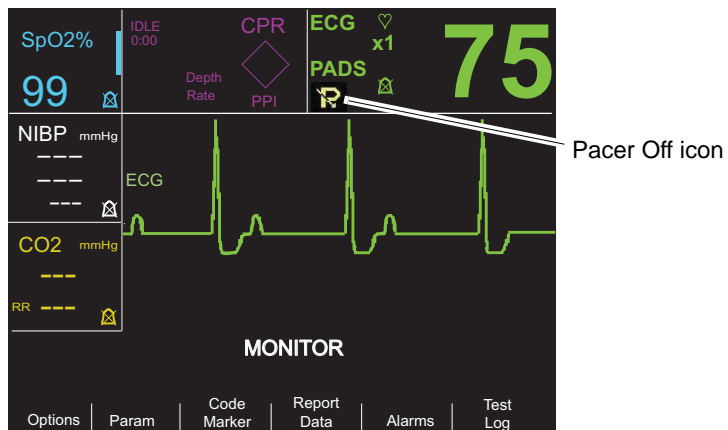
The R Series device can be configured to detect pacemaker signals from a patient with an implanted pacemaker and indicate their presence on the display. When pacemaker pulses are detected, the device displays a 5mm, vertical, solid line on the ECG trace.



To disable detection of pacemaker spikes:

1. Press the **Param** softkey.
2. Press **ECG**.
3. Press **Disable Pacer Detect**.

The Pacer Off icon () appears in the ECG field to indicate that detection and rejection of implanted pacemaker pulses by the heart rate detector is disabled. Do not disable the implanted pacemaker detector when monitoring patients known or suspected to have an implanted pacer. Disabling pacemaker pulse detection under these conditions can result in erroneously counting pacemaker pulses as R-waves leading to the display of inaccurate heart rates.



To re-enable detection of pacemaker spikes:

1. Press the **Param** softkey.
2. Press **ECG**.
3. Press **Enable Pacer Detect**.



---

## 5-Lead Monitoring

You can perform 5-lead ECG monitoring with the appropriate ECG patient cable. The 5-lead cable allows you to monitor the following ECG leads:

- I, II, III
- aVR, aVL, aVF
- V1

### Changing from 3-Lead Monitoring

To change from 3-lead to 5-lead monitoring, simply disconnect the 3-Lead ECG patient cable (or OneStep Pacing cable ECG connector) and connect the 5-lead ECG cable. Refer to the beginning of this section for appropriate preparations (i.e., placing electrodes, attaching electrodes, setting the controls, etc.).

If any ECG lead becomes disconnected during monitoring, an *ECG LEAD OFF* message appears on the display.

### Changing from 5-Lead ECG Monitoring

To change from 5-lead monitoring to 3-lead monitoring, you must power off the unit for at least 10 seconds, remove the 5-lead cable, connect the 3-lead cable, then power on the unit again. If you fail to shut the unit off for at least 10 seconds, the unit displays the *ECG LEAD OFF* message after you disconnect the 5-lead wire cable, even if leads from a 3 lead ECG cable are properly attached to the patient.

## Simultaneous 3-Lead Printing

The R Series unit can display and print three simultaneous ECG leads when using a 5 lead cable and an ECG lead is selected as the signal source (not PADS or PADDLES).

**Note:** This feature does not work with a 3 lead cable or in Pacer mode.

To display and print 3 simultaneous leads:

1. Press the **Options** softkey, then press the **Traces** softkey.
2. Press **3 Leads**.

Leads belong to two groups: limb leads (I, II and III) and augmented leads (aVR, aVL, and aVF). The selected lead is always displayed and printed in the Trace 1 uppermost position. The other two leads are displayed in the Trace 2 and 3 positions. For example, if aVL is the selected Trace 1 lead, the Trace 2 and 3 positions display aVR, and aVF respectively.

3 ECG leads will also be printed (when an ECG lead is selected) if the “Print 3 Leads When Leads are Sel.” configuration option is set to YES. Refer to the *R Series Configuration Guide* for instructions.

## See-Thru CPR Filter (R Series Plus Only)

The See-Thru CPR feature is only available with R Series Plus models. When OneStep CPR electrodes or OneStep Complete electrodes are in use, the R Series unit allows simultaneous display and printing of the selected ECG lead and the same ECG lead with CPR filtering applied. The CPR filter uses signals from the electrode’s CPR sensor to help reduce artifact in

the ECG signal caused by mechanical compressions of the chest, thereby providing a clearer view of the ECG during periods of CPR. For more detailed information on this feature, see Chapter 8, "See-Thru CPR (R Series Plus Only)".

To apply the See-Thru CPR Filter to the selected ECG lead and display it:

1. Press the **Options** softkey, then press the **Traces** softkey.
2. Press the **Trace 2** or **Trace 3** softkey.
3. Press **Filt ECG**.

If Display Filtered ECG in Trace1 is configured, the unit displays the filtered ECG in Trace1. You can then switch between filtered and unfiltered ECG using the **Enable/Disable Filt ECG** softkey. With the unfiltered ECG displayed in Trace1, the user of the R Series unit can also enable the display of the filtered ECG in Trace2 or Trace3.

## Adding Traces to Be Displayed

The screen can display up to three traces simultaneously. The trace for the selected ECG lead always appears in the Trace 1 uppermost position.

If optional physiological monitoring parameters are installed in the unit, the operator can select applicable traces to appear in the second or third position.

To select the display for the second or third trace:

1. Press the **Options** softkey, then press **Traces**.
2. Press **Trace 2** or **Trace 3** to select the position.
3. Press the softkey for the parameter or other waveform to display in the selected position (or **Off** to clear that position).

**Note:** Trace 3 is not available while the unit is in Pacer mode.

## Printing the ECG on a Stripchart

The stripchart recorder documents the ECG trace with a 6 second delay at all times. To start the stripchart recorder, press the **RECORDER** button. The stripchart recorder runs continuously until you press the button again.

Each time the strip chart recorder is started, the time, date, ECG lead, size, and heart rate are printed on the top part of the paper. If the unit is pacing, the output current is also printed.

**Note:** Check the paper supply at the beginning of each shift and after each use to ensure adequate recording capability. A colored stripe on the paper means that the paper supply is low.

A *CHECK RECORDER* message appears on the display when the stripchart recorder is activated without paper. The stripchart recorder automatically shuts off when there is no paper.

After loading new paper, press the **RECORDER** button to start the strip chart recorder.

## Diagnostic Bandwidth

When using an ECG cable for monitoring, you can switch the unit to diagnostic bandwidth (0.05-150 Hz) by pressing and holding the **RECORDER** button depressed. Diagnostic

bandwidth is maintained and printing continues as long as the **RECORDER** button is held down. The unit reverts to standard monitoring bandwidth when you release the **RECORDER** button.

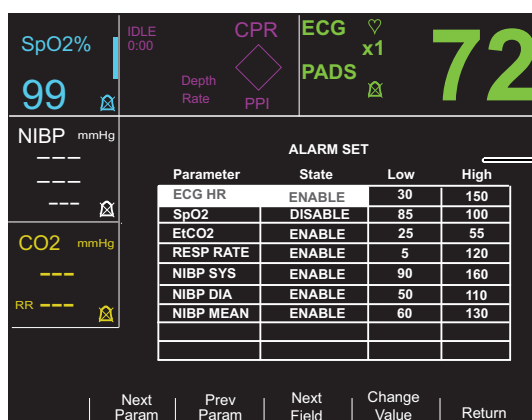
## Alarms

### Setting Alarm Limits

Unless configured otherwise, heart rate alarms are preset at 30 bpm (bradycardia) and 150 bpm (tachycardia). Refer to the *R Series Configuration Guide* for details on setting power-up alarm limits.

To set alarm parameters:

1. Press the **Alarms** softkey to view the Alarm Set screen and softkeys.



Each setting includes the alarm state (ENABLE, DISABLE, or AUTO) and the low and high limit of the acceptable range of

2. Press the **Next Param** or **Prev Param** softkey.

This scrolls the highlighted area among the different available vital signs.

If you want to change the state of the highlighted vital sign:

- a. Press the **Change Value** softkey.
- b. Press the **Inc >** or **Dec <** softkey to change the state value.
- c. Press the **Enter** softkey.

The State field can be set to three possible values, Enable, Disable, or Auto.

- Disable permanently turns off alarm processing for the selected physiological parameter.
- Enable causes alarm processing to operate whenever alarms are activated via the front panel **ALARM** key.
- Selecting AUTO sets the lower and upper alarm limits to 80% and 120% of the patient's currently measured heart rate, if valid measurements are present for the vital sign when the **Enter** softkey is pressed. (Refer to appropriate Operator's Guide parameter insert(s) for percentages associated with other parameters).

3. Press the **Next Field** softkey to move to the Low or High field for the highlighted vital sign; repeat steps 2a through 2c to change the Low or High value.

**Note:** To recalculate the Low and High limits for any parameter when these limits have previously been set using the AUTO State, follow the procedure above to select AUTO again, and then press the **Enter** softkey. The unit automatically resets the Low and High limits based upon the currently measured value of the selected physiological parameter.

4. Press the **Return** softkey to set all values and return to normal operating mode.

## Heart Rate Alarm Limits

The heart rate is displayed in the upper right-hand corner of the screen.

Unless configured otherwise, heart rate alarms are preset at 30 bpm (bradycardia) and 150 bpm (tachycardia). The low heart rate alarm limit range is 20 bpm to 100 bpm.

When the unit is monitoring a patient's heart rate via ECG, the range for the high heart rate alarm limit is 60 to 280 bpm with a default setting of 150 bpm. When the unit is monitoring a patient's pulse rate via pulse oximetry (SpO<sub>2</sub>), however, the unit automatically lowers the upper limit for the high heart rate alarm to 235 bpm. The unit restores the original high heart rate alarm limit when ECG monitoring resumes.

## Vital Sign Alarms

Each vital sign has associated high and low alarm limits. You can set alarm limits for patient heart rate and other optional monitoring parameters such as pulse oximetry (SpO<sub>2</sub>), non-invasive blood pressure (NIBP), or end-tidal carbon dioxide monitoring (EtCO<sub>2</sub>), if available.

The R Series unit has three levels of alarms:

- **High Priority** — Reflects physiological parameters that are out of bounds. When these alerts occur, the unit emits an audio tone at 2.86 KHz, highlights the alarming parameter, and flashes the associated alarm bell.
- **Medium Priority** — Reflects equipment- related, user correctable faults such as *LEAD OFF*. The unit emits a two beep audio tone and displays a message for a timed period.
- **Low Priority** — Informational message only; the unit emits a two beep audio tone and displays a message for a timed period.

## Suspending and Silencing Alarms

When a high priority alarm occurs, the unit emits a continuous alarm tone, highlights the value of the alarming parameter on the display, and flashes the bell icon associated with that parameter.

You can either suspend the alarm tone for 90 seconds or you can silence the alarm tone.

### Suspending Alarm Tones



To suspend an alarm tone for 90 seconds, press and release the **ALARM SUSPEND** button in *less than 1 second*. The alarm tone stops, the unit displays an "X" across the alarm's flashing bell icon, and the value for the alarming parameter remains highlighted. (If you press the **ALARM SUSPEND** button again, alarm processing is reactivated.)

After 90 seconds, if the physiological parameter remains at a value that triggers the alarm, the unit sounds the alarm tone again.



If the alarm condition clears (the physiological parameter returns to a value within range) after you suspend the alarm tone, the unit resets the alarm and displays the bell icon (no flashing, no “X”). The alarm parameter displays normally (no highlighting).

If a second, different alarm occurs after you suspend an alarm tone, you can suspend the alarm tone for that second parameter by pressing and releasing the **ALARM SUSPEND** button again. The unit behaves the same as described above for the first alarm. Suspending a second alarm does not alter the timing or processing of the previously suspended alarm.

### Silencing Alarm Tones



To silence the alarm tone, *press and hold down* the **ALARM SUSPEND** button for *between 1 and 3 seconds*. The alarm tone stops, the unit displays the alarm’s bell icon in inverse video with an “X” across it, and the value of the alarm parameter remains highlighted. (If you press the **ALARM SUSPEND** button again, alarm processing is reactivated.)

The alarm tone will not sound again as long as the physiological parameter’s value remains out of range.



If the alarm condition clears (the physiological parameter returns to a value within range) after you silence the alarm tone, the unit resets the alarm and displays the bell icon (no inverse video, no “X”). The alarm parameter value displays normally (no highlighting).

After the unit resets an alarm, should the physiological parameter again go out of range, it will trigger the alarm.

### Activating and Deactivating Alarm Processing



To deactivate all alarms on the R Series unit, *press and hold down* the **ALARM SUSPEND** button for *3 seconds or longer*. The bell icons for all alarms will have an “X” through them to indicate that the alarms are deactivated. Alarm parameter values display normally (no highlighting).

To reactivate the alarms, press and release the **ALARM SUSPEND** button in *less than 1 second*.

## Smart Alarms

In Manual mode, ECG/heart rate alarm capabilities are enhanced with the defibrillation advisory feature called Smart Alarms. When alarms are operating, this feature triggers an audible alarm and displays the message *CHECK PATIENT* whenever the unit detects ventricular fibrillation or wide complex ventricular tachycardias. This message appears on the display and the stripchart recorder print out.

If alarms are operating in PACER mode, the unit displays *VF ALARMS OFF*, indicating that the Smart Alarms feature has been disabled.

The Smart Alarms feature is always disabled when augmented leads (aVR, aVL, aVF), V-leads, or PADDLES are selected for ECG monitoring. The messages *VF ALARMS OFF* and *SELECT LIMB LEADS* are alternately displayed when alarms are activated and augmented leads or V-leads are selected. These messages are displayed only the first time you select the augmented or V-leads. They are not redisplayed as you cycle through the lead selection.

## **Alarm Settings for Unattended Monitoring**

Alarms for all monitored parameters should be activated whenever a patient is left unattended. Alarm limits should be intentionally set to levels appropriate for detecting relevant changes in the patient's condition. Leaving alarm settings at their default levels or setting them to the extremes of their ranges may defeat the utility of the alarms even when they are activated.

# Chapter 11

## Event Records and Reports

---

**Note:** This option is only available in Manual mode.

The R Series defibrillator records important event information during operation. You can retrieve this information in various forms:

- **Summary Report** — Summary report allows you to store and later retrieve important ECG and event information. You can print summary report information in various formats. For more information about Summary Report and how to print a report, refer to the Summary Report section below.
- **Full Disclosure Recording** — Full Disclosure waveforms along with event information are stored and may be reviewed using ZOLL CodeNet Central software. For information about Full Disclosure Recording, refer to “Full Disclosure Recording” on page 11-8.
- **Incident Log** — The Incident log is an abbreviated list of all major events recorded in Summary Report. For more information about the Incident log and how to print it, refer to “Printing an Incident Log” on page 11-8.

### Summary Report

The R Series defibrillator automatically records defibrillation and cardioversion events, PACER mode information, heart rate alarms, and segments of ECG when the recorder is activated. Associated event information including device control settings, time, and date are also recorded.

The following events trigger Summary Report to automatically record information:

- Power is turned on.
- Unit is in Manual mode.
- Stripchart recorder is turned on.
- Defibrillator shock is administered.
- Code markers entered.

- ECG rhythm analysis is initiated.
- VF alarm is triggered.
- Parameter alarm is triggered.
- Mode Selector is turned to PACER (after entering Manual mode).

**Note:** Diagnostic bandwidth recordings are not included in Summary Report.

The unit stores and prints summary information in chronological order. The memory allocated for summary data can hold up to 350 defibrillation or 350 recorder-activated events. All event data remains in memory and is accessible until data is manually erased or until the preconfigured time interval has elapsed. (The time interval is specified in the Set Report Restart Delay parameter; see the *R Series Configuration Manual* for more information). A new patient record is automatically created when the unit has been turned off for a configurable time period of 5 minutes to 72 hours. When all memory for code summary is used, the unit issues the message *REPORT FULL*.

To continue recording the code event after the memory has been filled or to prepare the unit for a new code, the operator can erase the stored records. (Refer to “Erasing Summary Report and Full Disclosure” on page 11-9.)

## Summary Report Formats

This section describes the information included with each type of summary report record.

Each summary report begins with an overview of all events currently stored in memory including:

- Date and time
- Report start time (either when the unit was turned on or, if data was manually erased, when subsequent recording began)
- Time of the last recorded event
- Total number of shocks delivered
- Cumulative pacing time
- Device ID
- System serial number

Space is provided for patient name and comments. On the last event recorded, the unit prints “SUMMARY COMPLETE” on the bottom left of the stripchart.

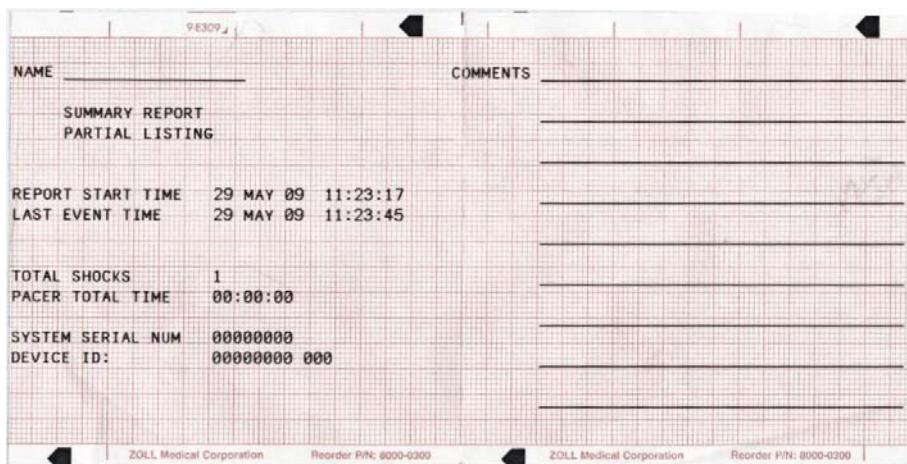


Figure 11-1. Summary Report



### Defibrillation Event Format

The summary report function records 6 seconds of pre-shock and 9 seconds of post-shock patient ECG data. Also recorded are joules selected, joules delivered, Sync if active (includes Sync markers), ECG lead, ECG size, patient current, defib impedance, actual time and date. The date/time printed on the top of the strip corresponds to the ECG data occurring 6 seconds before the event.

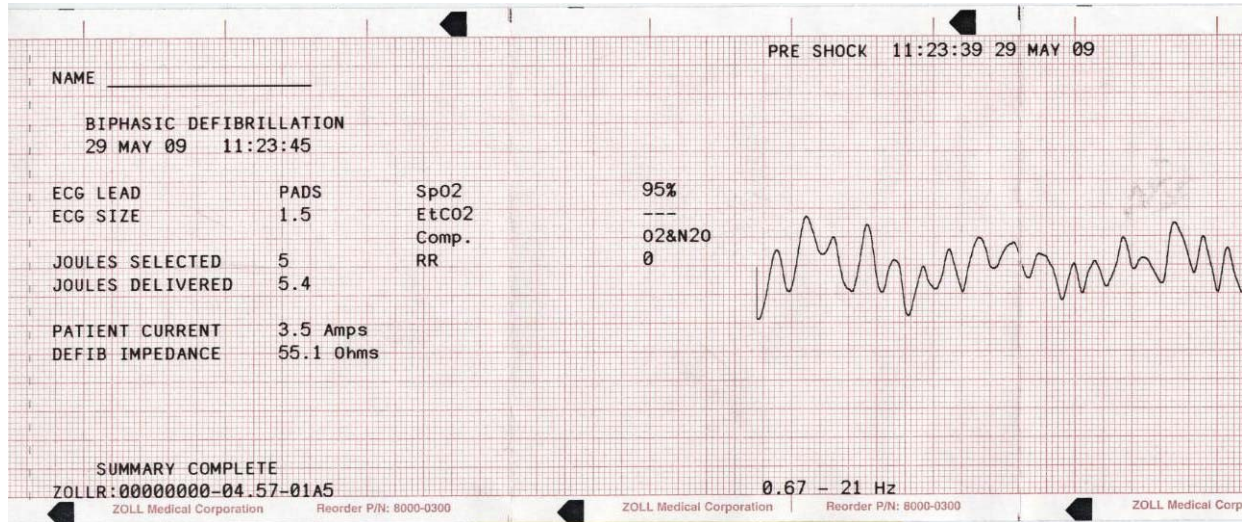


Figure 11-2. Defibrillation Event Format (Pre-Shock)

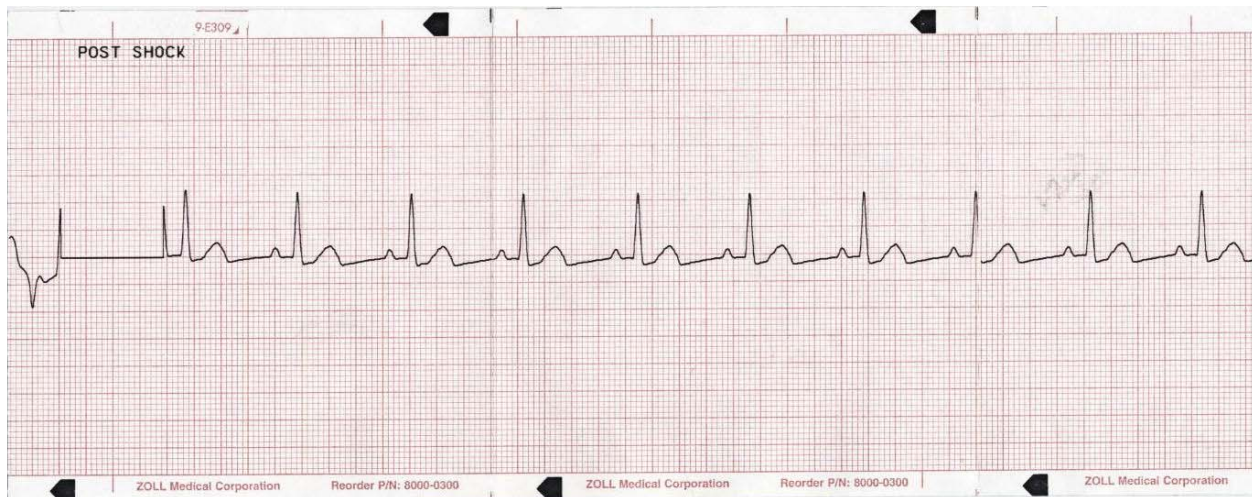
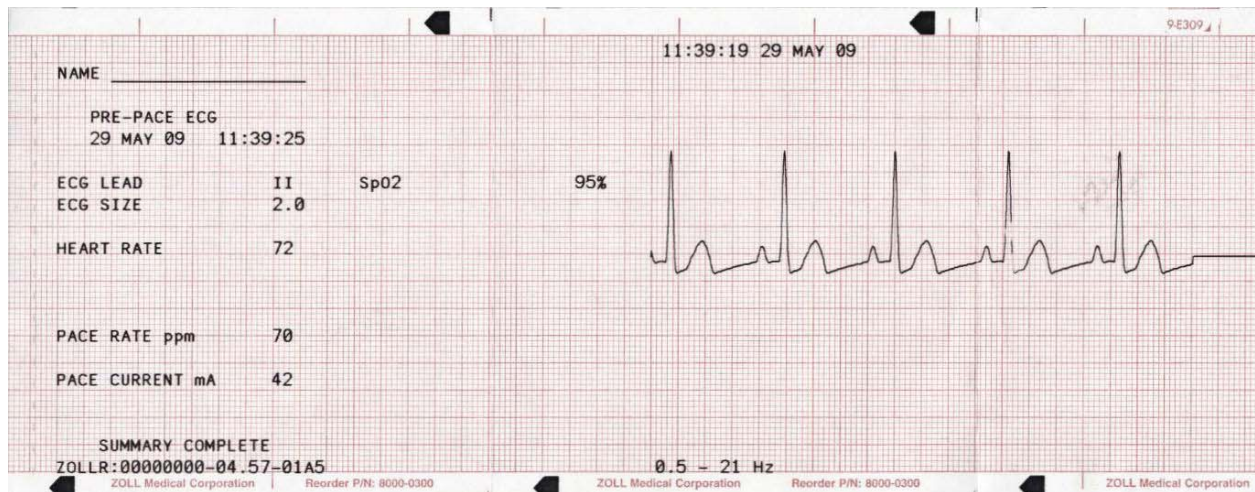


Figure 11-3. Defibrillation Event Format (Post Shock)

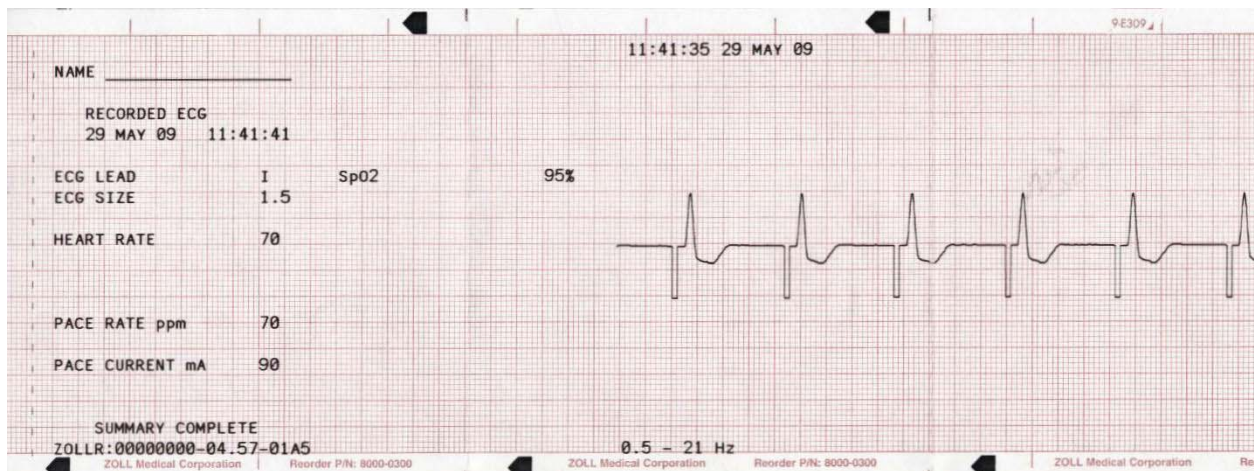
### Pacer Mode Selected Format

The summary report function records 6 seconds of pre-pace patient ECG data. Also recorded are the ECG lead, ECG size, patient's heart rate, pace rate, pace current, time and date. The date/time printed on the top of the strip corresponds to the ECG data occurring 6 seconds before the event.



**Figure 11-4. Pacer Mode Selected Format**

After establishing a paced rhythm, turning the recorder on briefly records the paced rhythm for later reports. If async pace is active, the annotation *ASync PACE* is also recorded and printed. The date/time printed on the top of the strip corresponds to the ECG data occurring 6 seconds before the event.



**Figure 11-5. Pacer Mode Selected Format (Asynchronous Pacing)**

### Heart Rate Alarm Activated Format

The summary report function records 6 seconds of pre-alarm patient ECG. Also recorded are the ECG lead, ECG size, patient's heart rate, actual event time, and date. The date/time printed on the top of the strip corresponds to the ECG data occurring 6 seconds before the event. If the pacer is on during this event, the pacing rate and pacing current are also recorded.



Figure 11-6. Heart Rate Alarm Activated Format

### VF Alarm Activated Format

The summary report function records 18 seconds of patient ECG data associated with each VF alarm. Also recorded are the ECG lead, ECG size, actual event time, the number of noise events, and the message *CHECK PATIENT*. The date/time printed on the top of the strip corresponds to the ECG data occurring 6 seconds before the event.

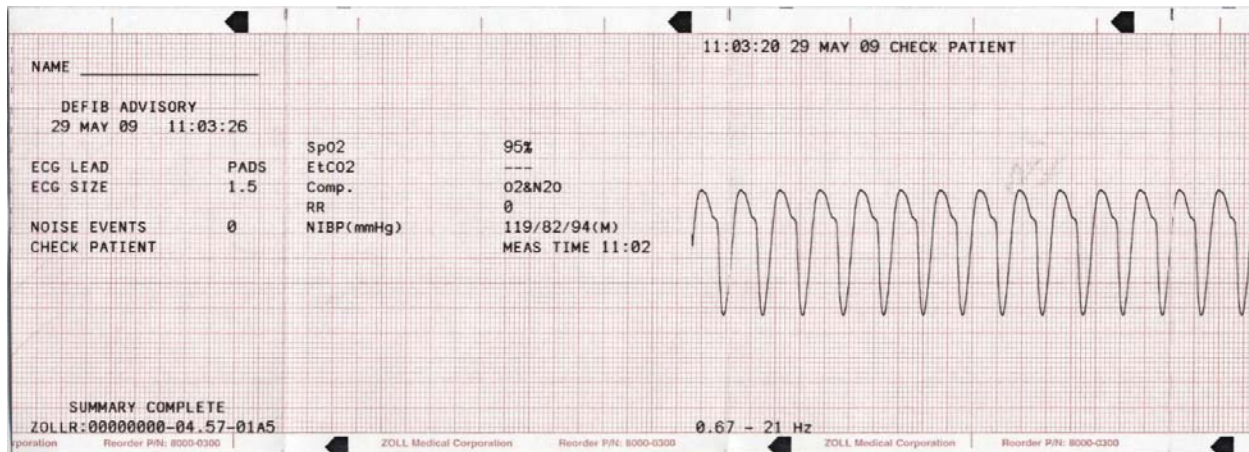


Figure 11-7. VF Alarm Activated Format

### Recorder On Format

The summary report function records 6 seconds of patient ECG prior to turning on the recorder. Also recorded are the ECG lead, ECG size, patient's heart rate, actual event time, and date. The date/time printed on the top of the strip corresponds to the ECG data occurring 6 seconds before the event. If the pacer is on during this event, the pacing rate and current are also recorded. If asynchronous pace is active, the annotation *ASYNC PACE* is recorded.

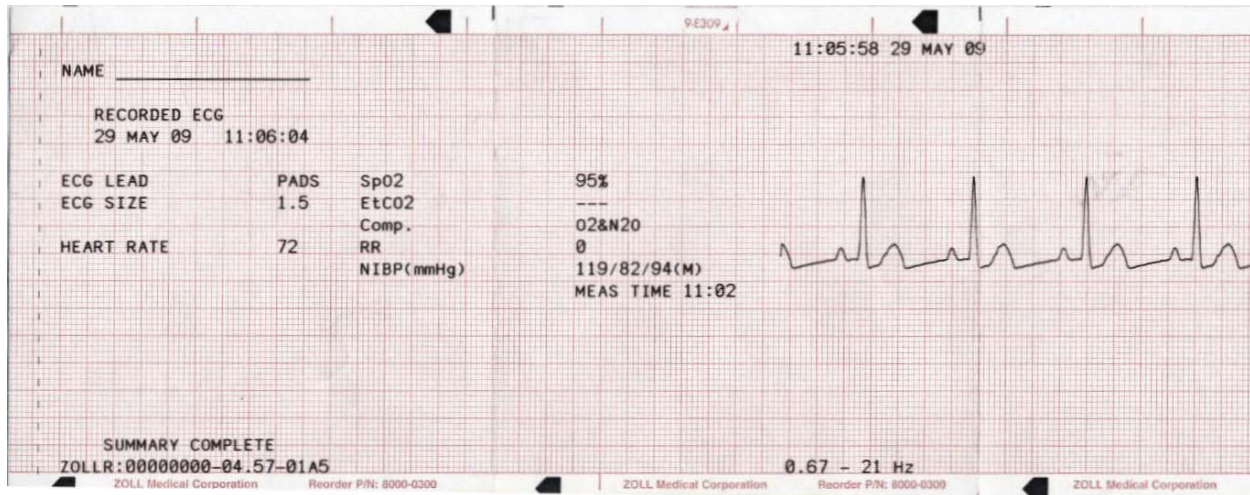


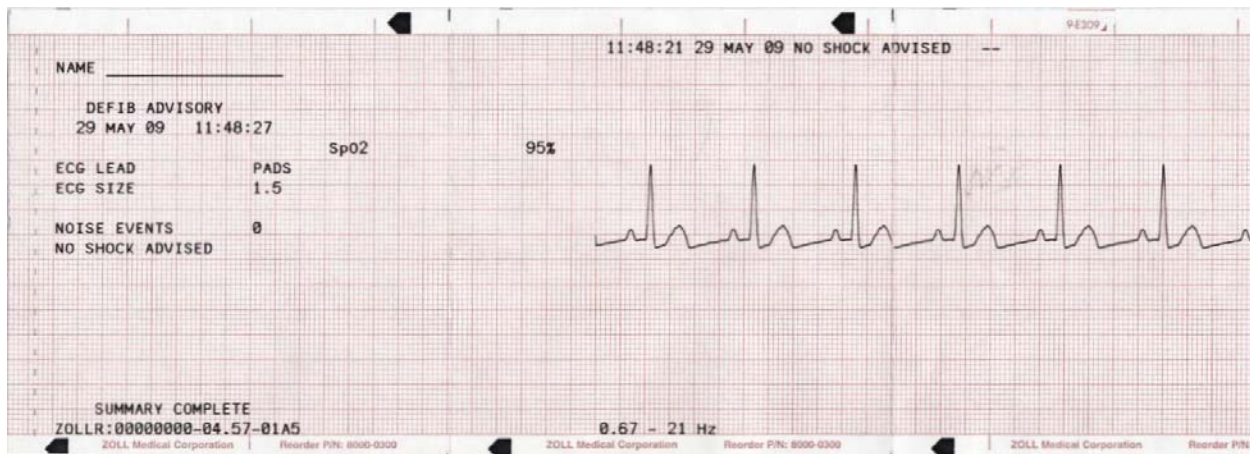
Figure 11-8. Recorder On Format

### Analyze Format

The summary report function records six seconds of pre analysis ECG, 12 seconds of ECG recorded during the analysis and the annotation *SHOCK ADVISED* or *NO SHOCK ADVISED*. The date/time printed on the top of the strip corresponds to the ECG data occurring 6 seconds before the analysis was started.

The analysis normally consists of three consecutive 3-second ECG rhythm analyses. Each segment is represented at the top of the strip with either an asterisk (\*) for shockable, or a dash (-) for non shockable. The unit automatically charges to the preconfigured energy level upon detection of the first shockable segment. If at least two of the three analyses determine that the patient has a shockable rhythm, the unit will prompt the operator to shock the patient. If two or more of the three 3-second ECG analyses do not detect a shockable rhythm, the unit alerts the operator that no shock is advised.

**Note:** If the first two segments are shockable, only two asterisks appear on the stripchart, and the third segment is not analyzed.



**Figure 11-9. Analyze Format**

In addition, the ECG rhythm analysis report can include the following annotations:

Annotation	Description
<i>POOR PAD CONTACT</i>	The hands-free therapy electrodes are improperly connected.
<i>ANALYSIS HALTED</i>	A fault condition occurred, or the operator pressed the <b>ANALYZE</b> button again.
<i>NOISY ECG</i>	Excessive noise was detected.
<i>SHOCK ADVISED</i>	A shockable rhythm was detected.
<i>NO SHOCK ADV.</i>	No shockable rhythm was detected.

## Printing the Entire Summary Report

To print all summary report data:

1. Press the **Report Data** softkey, then press **Print Chart**.
2. Press the **Print All** softkey.

The unit prints all stored code events and code markers in chronological order beginning with the oldest entry. If the stripchart recorder is on or the defibrillator is charged, summary report printing is disabled. To stop printing a report, press the **RECORDER** button or turn off the unit. You can print an unlimited number of copies of the report by repeating this procedure.

**Note:** Summary report printing is interrupted when a, ECG analysis is in progress, or the defibrillator is charging or charged. Also, if a summary report is printing and you press the **Report** softkey to print another type of report (such as the log report), the device stops printing the summary report and begins printing the selected report.

If the recorder is out of paper when the **Report Data** softkey and a corresponding print softkey are pressed, a *CHECK RECORDER* message appears on the display. Load paper and press the **Report Data** softkey again to select the report to print.

## Printing a Partial Summary Report

To print a partial summary report:

1. Press the **Report Data** softkey, then press **Print Chart**.
2. Press the **Print Range** softkey.
3. Use the **First Event**, **Prev. Event**, **Next Event** and **Last Event** softkeys to locate the event from which printing will start (all subsequent events are also printed).
4. Press the **Print** softkey.

The unit prints all records from the selected item to the most recent.

**Note:** The overview information (such as the number of shocks delivered) covers all stored summary data, not just the selected range.

## Full Disclosure Recording

Along with event information captured in Summary Report, R Series also records the full disclosure CPR sensor and parameter waveforms. The full disclosure recording on the unit can accommodate at least 6 hours of data. Full disclosure recordings are erased at the same times as Summary Reports.

## Incident Logs

An incident log is an abbreviated list of all major events recorded in summary report. You can print an incident log that includes the following events and their time of occurrence.

- Unit powered on.
- Unit is in Manual mode.
- Defibrillation advisory message issued (for example, *CHECK PATIENT* or *SHOCK ADVISED*)
- Shock delivered (and energy level)
- PACER mode selected
- Alarm triggered
- Stripchart printing started
- Code marker entered

In addition, the incident log lists the following:

- System serial number
- Device identification number
- Report start time (when the summary data was last erased)
- Time of the last recorded event
- Total number of shocks delivered
- Total cumulative pacing time

## Printing an Incident Log

To print an incident log, press the **Report Data** softkey, then press the **Print Log** softkey.

The log is printed on the stripchart, starting with the oldest entry.

# Erasing Summary Report and Full Disclosure

Summary information can be erased either manually or automatically.

## Manual Erasure

You can manually erase summary records and full disclosure data from memory in preparation for collecting data for a new patient.

**Note:** When the event summary memory and full disclosure memory are filled, data recording stops. You must erase the records to continue recording.

Make sure to print out any important summary records currently in memory. Transfer important full disclosure records to ZOLL CodeNet Central.

To manually erase stored data:

1. Press the **Report Data** softkey.
2. Press the **Erase** softkey, then the **Erase Report** softkey. To erase all reports stored in the unit, press **Erase All**.

## Automatic Erasure

Automatic erasure of summary report and full disclosure data occurs if the R Series unit has been turned off for a user-configurable period of 5 minutes to 72 hours.

## Formatting the Disk

The R Series uses an internal flash memory disk that stores the data in files similar in structure to those on a personal computer hard drive. Like a personal computer, there may be rare occasions when the internal disk requires formatting. For example, this may occur if all power (battery and ac) is removed while erasing a report. Under such a circumstance, the message *DISK FORMAT REQ.* will be displayed. Perform the following steps to format the flash memory disk. All patient data will be erased during this procedure. If possible, print out any important summary records currently in memory and transfer important full disclosure records to ZOLL CodeNet Central.

1. Press the **Report Data** softkey.
2. Press the **Erase** softkey, then the **Format Disk** softkey.
3. When you are ready, press the **Confirm Format** softkey.

The messages *FORMATTING DISK* and *DO NOT POWER OFF* will be displayed while the disk is formatting. This procedure may take several minutes to complete.

## Related Messages

Message	Description
<i>CHECK RECORDER</i>	The paper supply in the stripchart printer is exhausted.
<i>DISK FORMAT REQ.</i>	The internal flash memory disk file system has been corrupted. Follow the procedure in the previous section, "Formatting the Disk."
<i>DO NOT POWER OFF</i>	Do not remove power (both battery and AC) while the unit is erasing reports or formatting the disk.
<i>ERASING REPORT</i>	The unit is erasing the selected report data.
<i>FORMATTING DISK</i>	The internal flash memory disk is being formatted.



# Chapter 12

## File Transfer

---

This chapter describes procedures for transferring files from the R Series defibrillator to an external system, such as a personal computer or handheld device. It also explains how to remove, install and erase a Compact Flash card.

**Note:** The USB and Wi-Fi capabilities that are included in this chapter are only available if you have the R Series Plus model. The file transfer option is only available when you are in Manual mode.

While you are in Transfer Data mode, if you press any of the buttons on the right side of the front panel (**SHOCK, ANALYZE, CHARGE, ENERGY SELECT**), the following message is displayed: *SELECT DEFIB MODE*. To enable the defibrillator in Manual mode, press the **Exit Transfer** softkey, or quickly turn the Mode Selector to **OFF** and then **ON**.

### Transferring Files to an External Device

You can transfer the following files from the R Series defibrillator to an external device:

- Device check, activity log, and full disclosure waveforms
- Defibrillator test information

The unit includes the following data transfer features:

- 802.11 Wi-Fi (R Series Plus Only)
- USB device connector (R Series Plus Only)
- Compact flash card slot

**Note:** When the unit is transferring data via Wi-Fi, it is in a non-clinical mode. No treatment or monitoring of the patient is available in this mode.

To retrieve and review event files, you need one of the following software packages installed on the receiving equipment:

- ZOLL CodeNet Central software
- ZOLL RescueNet Code Review software

To retrieve and review maintenance files, you need ZOLL Defib Dashboard software installed on the receiving equipment.

R Series defibrillators use the Microsoft Windows file structure for stored records. Files can be transferred to a properly equipped Windows-based personal computer or handheld device. With CodeNet Central software, the personal computer allows the user to access the files for review.

If configured, the unit can display a reminder to transfer files while in clinical mode. When turned off, the unit displays the message *TURN UNIT ON AND ENTER DATA TRANSFER MODE TO TRANSFER REPORT* for 15 seconds. This is turned off by default; see the *R Series Configuration Guide* to change this setting.

## Wi-Fi (Optional)

The R Series has an optional Wireless Ethernet function that transfers data files using the IEEE 802.11 protocol (Wi-Fi). This includes a ZOLL R Series Data COMM Card or ZOLL R Series Data COMM II card, and a protective guard that must be installed on the unit. See *R Series Data COMM Instructions for Use and Wi-Fi Guard Installation* (Part number 9652-000395) or *R Series Data COMM II Instructions for Use and Wi-Fi Guard Installation* (Part number 9652-000405) for instructions on how to install the Wi-Fi Guard.

Do not clean the Data COMM or Data COMM II Card with isopropyl alcohol.

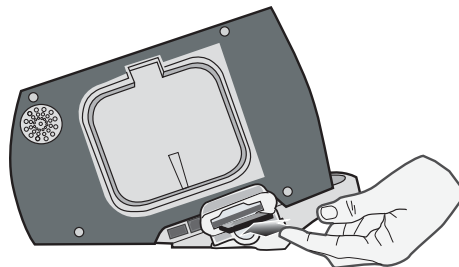
All file transfer operations are terminated when the defibrillator is switched to either Defib mode or Pacing mode, or powered off.

## Installing or Removing a Compact Flash Card

Before you begin, check the card and its connector to ensure that they are clean and undamaged.

### To install a compact flash card:

1. Insert the card, with its label side up, into the front slot on the lower left side of the unit.  
You can install a compact flash card while the unit is operating or while it is turned off.
2. Slide the card into the slot until it is firmly seated.



**Figure 12-1. Inserting Compact Flash Card**

**To remove a compact flash card:**

Press the release button and pull the card out of the slot.

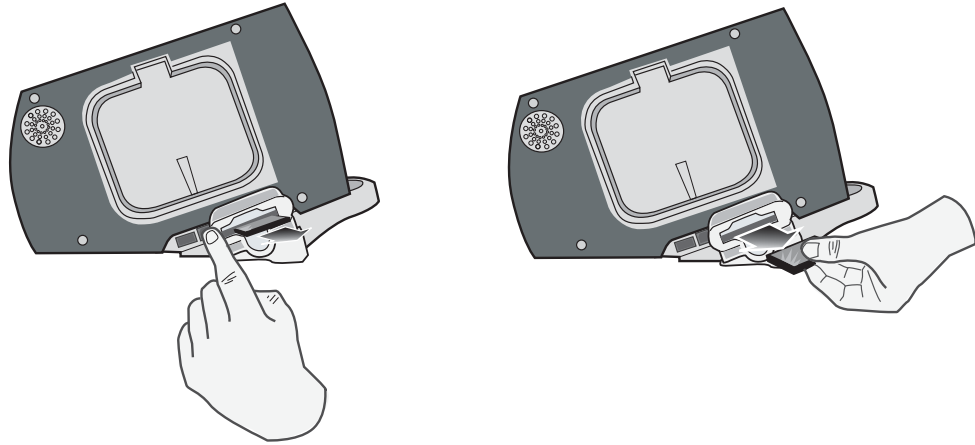


Figure 12-2. Removing a Compact Flash Card

## Transferring a Full Disclosure File to a Compact Flash Card

Make sure that a compact flash card is installed in the slot on the left side of the device.

To transfer data to a compact flash card:

1. Turn the Mode Selector to **ON**.
2. Press the **Manual Mode** softkey.

**Note:** If the *CONFIRM MANUAL MODE* message displays, press the **Confirm** softkey to enter the Manual mode of operation.

3. Press the **Report Data** softkey.
4. Press the **Transfer Mode** softkey.
5. Press the **Report to Card** softkey.

The message *TRANSFERRING DATA* is displayed. The full disclosure file is transferred to the installed CF data card.

**Note:** Do not remove the CF card while files are transferring. Corruption may result on the data card.

When all files are transferred, the message *DATA TRANSFERRED* is displayed. You can now remove the CF card from the R Series unit.

To exit Data Transfer Mode, press the **Exit Transfer** softkey.

## Transferring Device Check and Activity Log Files to a Compact Flash Card

Make sure that a compact flash card is installed in the slot on the left side of the device.

To copy the Device Check or Activity Log to a CF card:

1. Turn the Mode Selector to **ON**.
2. Press the **Manual Mode** softkey.

**Note:** If the *CONFIRM MANUAL MODE* message displays, press the **Confirm** softkey to enter the Manual mode of operation.

3. Press the **Report Data** softkey.
4. Press the **Transfer Mode** softkey.
5. Press the **More** softkey.
6. Press the **Defib History to Card** softkey.

The message *TRANSFERRING DATA* is displayed. The activity log and test file is transferred to the installed CF data card.

**Note:** If the messages *CF TRANSFER FAILED* and then *TRANSFERRING DATA* display, make sure you have a CF card installed and not a Wi-Fi card. Press the **Return** softkey and then the **Exit Transfer** softkey to return to defibrillation operation mode.

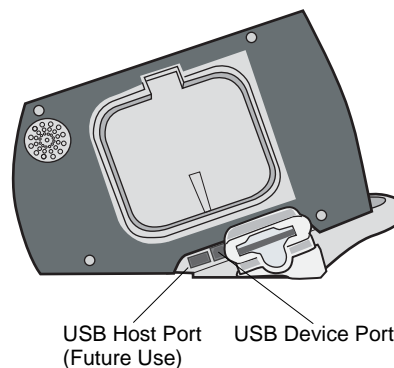
**Note:** Do not remove the CF card while files are transferring. Corruption may result on the data card.

When all files are transferred, the message *DATA TRANSFERRED* is displayed. You can now remove the CF card from the R Series unit.

To exit Data Transfer Mode, press the **Return** softkey and then the **Exit Transfer** softkey.

## Transferring Files Through the USB Port (R Series Plus Only)

Before you begin, connect a USB cable from the Windows external device with USB host capability (for example, a Window PC), to the R Series defibrillator USB device port.



**Figure 12-3. USB Ports**

To transfer data through the USB port:

1. Turn the Mode Selector to **ON**.
2. Press the **Manual Mode** softkey.

**Note:** If the *CONFIRM MANUAL MODE* message displays, press the **Confirm** softkey to enter the Manual mode of operation.

3. Press the **Report Data** softkey.
4. Press the **Transfer Mode** softkey.
5. Press the **More** softkey.
6. Press the **Enable USB** softkey.

The R Series is now in USB Transfer Mode.

7. Initiate data transfer using ZOLL CodeNet Central or RescueNet Code Review software.

To exit USB Transfer mode, press the **Disable USB** softkey or switch the Mode Selector to **OFF**.

## Transferring Full Disclosure Files Through Wi-Fi (R Series Plus Only)

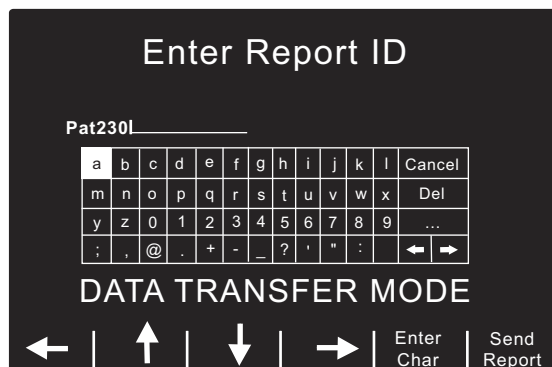
Before you begin, ensure the Wi-Fi card is properly seated with the name R Series Data COMM or Data COMM II facing up in the compact flash slot. Make sure that the Wi-Fi guard has been attached.

To transfer data through Wi-Fi:

1. Turn the Mode Selector to **ON**.
2. Press the **Manual Mode** softkey.

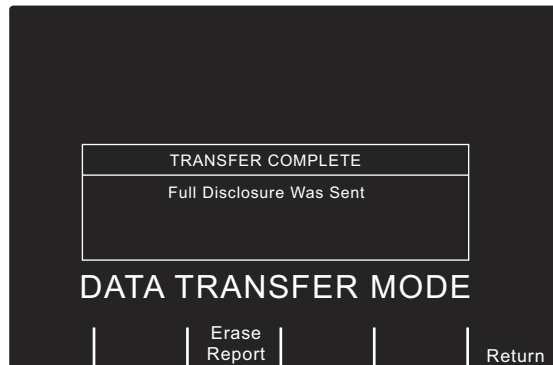
**Note:** If the *CONFIRM MANUAL MODE* message displays, press the **Confirm** softkey to enter the Manual mode of operation.

3. Press the **Report Data** softkey.
4. Press the **Transfer Mode** softkey.
5. Press the **Report to Wi-Fi** softkey.
6. The Enter Report ID screen will appear, and you will be prompted to enter a unique report ID. Use the arrow keys to select the desired characters, then press the **Enter Char** softkey. Pressing the ... key will change the table to a different set of characters, including upper case letters. To cancel and return to the previous screen, use the arrow keys and select Cancel.



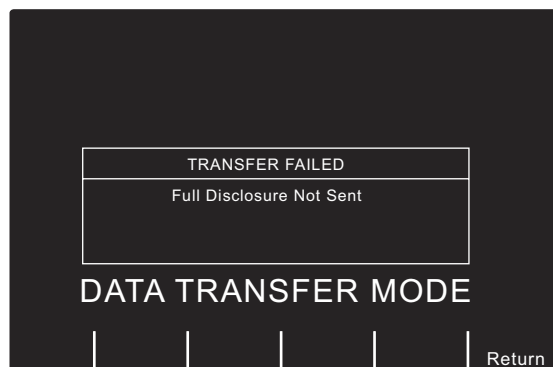
**Note:** Enable Report ID must be enabled in System Configuration mode for the report screen to appear (See the *R Series Configuration Guide*). If Enable Report ID is set to No, then the screen will not be displayed and the report will be sent immediately.

- To send the report, press the **Send Report** softkey. The R Series is now in Wi-Fi Transfer Mode and a status text message box appears in the middle of the screen and describes the status of the file being sent. When the full disclosure file is transferred, the messages *TRANSFER COMPLETE* and *Full Disclosure Was Sent* are displayed.



- To erase the report, press the **Erase Report** softkey. To keep the report and return to the Transfer Mode screen, press the **Return** softkey.

**Note:** If you are out of the range of an access point, the data will not be transferred and the message *Wi-Fi Network Not Found* is displayed. Press the **Return** softkey to return to the previous menu and try again.



To exit Wi-Fi/DataTransfer Mode, press the **Return** softkey and then the **Exit Transfer** softkey or switch the Mode Selector to **OFF**.

## Transferring Device Check and Activity Log Files Through Wi-Fi (R Series Plus Only)

Before you begin, ensure the Wi-Fi card is properly seated with the name R Series Data COMM or Data COMM II facing up in the compact flash slot. Make sure that the Wi-Fi guard has been attached.

To transfer data through Wi-Fi:

- Turn the Mode Selector to **ON**.
- Press the **Manual Mode** softkey.

**Note:** If the *CONFIRM MANUAL MODE* message displays, press the **Confirm** softkey to enter the Manual mode of operation.

3. Press the **Report Data** softkey.
4. Press the **Transfer Mode** softkey.
5. Press the **More** softkey.
6. Press the **Defib History to Wi-Fi** softkey.

The R Series is now in Wi-Fi Transfer Mode and a status text message box appears in the middle of the screen and describes the status of the files being sent. When the files are transferred, the message *TRANSFER COMPLETE* are displayed.

**Note:** If you are out of the range of an access point, the data will not be transferred and the message *Wi-Fi Network Not Found* is displayed.

To exit Wi-Fi/DataTransfer Mode, press the **Return** softkey and then the **Exit Transfer** softkey or switch the Mode Selector to **OFF**.

## Related Wi-Fi Messages

Informational Message	Description
<i>INITIALIZING NETWORK</i>	A transfer has been initiated.
<i>CONNECTING TO THE NETWORK</i>	The association with the host network is being established.
<i>CONNECTING TO SERVER</i>	The unit is connecting to a remote system.
<i>TRANSFER IN PROGRESS</i>	The data transfer is in progress.
<i>WAITING FOR SERVER RESPONSE</i>	The unit is waiting for the final acknowledgment from a remote system.
<i>TRANSFER COMPLETE</i> <i>XX Was Sent</i>  XX=file type (Full Disclosure, Activity Log, or Device check)	The data transfer is complete (and lists the file type that was sent).
Error Message	Description/Action
<i>TRANSFER FAILED</i> <i>Wi-Fi Card Not Detected</i> <i>Verify Installation of Wi-Fi Card</i>	The transfer failed because no Wi-Fi card is installed in the CF slot, or the card was ejected from the slot during transmission.  <b>Action:</b> Make sure that the correct Wi-Fi card is properly installed in the unit.
<i>TRANSFER FAILED</i> <i>Wi-fi Card Not Configured</i> <i>Contact Network Administrator</i>	The Wi-Fi card's configuration data is corrupt or blank.  <b>Action:</b> Verify the configuration settings on the Wi-Fi card. Contact the Network Administrator for assistance.

<p><i>TRANSFER FAILED</i> <i>Invalid Wi-Fi configuration</i> <i>Error Number: N</i> <i>Contact Network Administrator</i></p>	<p>The transfer failed because the Wi-Fi configuration was illegal. N indicates one of following error codes:</p> <p><i>N = 1: Local Static IP settings</i> <b>Action:</b> If running in Static IP mode, make sure that the relevant static IP addresses are not 0.0.0.0.</p> <p><i>N = 2: Server Static IP address</i> <b>Action:</b> With DNS set to No, make sure that the IP addresses for the Full Disclosure Server and Defib History Server are not 0.0.0.0.</p> <p><i>N = 3: Server Name</i> <b>Action:</b> With DNS set to Yes, make sure that valid names exist for the Full Disclosure Server and the Defib History Server.</p> <p><i>N = 4: DNS IP address</i> <b>Action:</b> With DHCP set to No and DNS set to Yes, make sure that the DNS IP Address is not 0.0.0.0.</p> <p><i>N = 5: SSID</i> <b>Action:</b> Make sure that there is at least one valid SSID for each desired mode (infrastructure and data management server).</p> <p><i>N = 6: Missing required configuration data for Network Profile 1 with Enterprise Authentication selected (Data COMM II only)</i> <b>Action:</b> Check the following: If Authentication Protocol is set to PEAP, make sure that the following are configured:</p> <ul style="list-style-type: none"><li>• User Identity</li><li>• User Password</li></ul> <p>If Authentication Protocol is set to TLS, make sure that the following are configured:</p> <ul style="list-style-type: none"><li>• User Identity</li><li>• Private Key Password</li><li>• Client Certificate</li></ul> <p><i>N = 7: Missing required configuration data for Network Profile 2 with Enterprise Authentication selected (Data COMM II only)</i> <b>Action:</b> Same as above.</p>
--	---



<p><i>TRANSFER FAILED</i>  <i>Invalid Wi-Fi configuration</i>  <i>Error Number: N</i>  <i>Contact Network Administrator</i></p> <p>(cont.)</p>	<p>N = 8: The Defib Upload Server's Username / Password are blank within the Full Disclosure and Defib History server configuration items Data COMM II only)</p> <p><b>Action:</b></p> <p>If Full Disclosure Transfer Mode is set to Server, make sure that the Username (Full Disclosure) and Password (Full Disclosure) entries are valid.</p> <p>If Defib History Transfer Mode is set to Manual, Automatic, or Both, make sure that the Username (Defib History) and Password (Defib History) entries are valid.</p> <p>N = 9: Missing required certificate file for Network Profile 1 with Enterprise Authentication selected (Data COMM II only)</p> <p><b>Action:</b></p> <p>If Authentication Protocol is set to PEAP, make sure that a root certificate has been added (if not using the default ZOLL root certificate).</p> <p>If Authentication Protocol set to TLS, make sure that a root certificate has been added (if not using the default ZOLL root certificate) and that the correct client certificate has been configured.</p> <p>N = 10: Missing required certificate file for Network Profile 2 with Enterprise Authentication selected (Data COMM II only)</p> <p><b>Action:</b> Same as above.</p>
<p><i>TRANSFER FAILED</i>  <i>Network Error: General</i>  <i>Error Number: NNNN</i>  <i>Contact Network Administrator</i></p>	<p>The transfer failed because of a general network Wi-Fi error. NNNN may indicate one of the following error codes:</p> <p>N = 7004  N = 7010  N = 7011  N = 7015  N = 7016</p> <p><b>Action:</b> Install another ZOLL Data COMM card.</p> <p>N = 7500  N = 7501  N = 7502  N = 7503  N = 7504  N = 7505  N = 7506  N = 7507</p> <p><b>Action:</b> Install another Data COMM II card.</p> <p>N = 7017</p> <p>Action: Make sure that the Defib Upload Server is running, is operational, and can be reached on the network.</p>

<p><i>TRANSFER FAILED</i> <i>Network Error: Unknown [-7002]</i></p>	<p><b>Action:</b> Make sure that no illegal characters are used for the SSID names.</p>
<p><i>TRANSFER FAILED</i> <i>Wi-Fi Card Failure</i> <i>Error Number: -7009</i> <i>Contact Network Administrator</i></p>	<p>The Wi-Fi card's configuration data is corrupt or cannot be read. (Data COMM only)</p> <p><b>Action:</b> Install another Data COMM card. Contact the Network Administrator for assistance.</p>
<p><i>TRANSFER FAILED</i> <i>Wi-Fi Network Not Found</i> <i>Contact Network Administrator</i></p>	<p>The R Series could not associate with a Wi-Fi network.</p> <p><b>Action:</b></p> <ol style="list-style-type: none"> <li>1) Make sure that the configuration values for the SSID names are correct.</li> <li>2) Make sure that the R Series unit is within range of the wireless server.</li> <li>3) Contact the Network Administrator for assistance.</li> </ol>
<p><i>TRANSFER FAILED</i> <i>Could Not Connect To Server</i> <i>Contact Network Administrator</i></p>	<p>The R Series could not communicate with the DefibUpload Server.</p> <p><b>Action:</b></p> <ol style="list-style-type: none"> <li>1) Make sure that the DefibUpload Server is running, is operational, and can be reached on the network.</li> <li>2) If WEP is enabled, make sure that the WEP keys on the R Series and Access Point match (value and slot location).</li> </ol>
<p><i>TRANSFER FAILED</i> <i>Network Error: DHCP</i> <i>Contact Network Administrator</i></p>	<p>The DHCP request has failed.</p> <p><b>Action:</b></p> <ol style="list-style-type: none"> <li>1) If WEP is enabled, make sure that the WEP keys on the R Series and Access Point match (value and slot location).</li> <li>2) Make sure that the DHCP server is operational.</li> </ol>
<p><i>TRANSFER FAILED</i> <i>Network Error: DNS</i> <i>Contact Network Administrator</i></p>	<p>The DNS request has failed.</p> <p><b>Action:</b></p> <ol style="list-style-type: none"> <li>1) Make sure that the DNS server is running, operational, and properly configured.</li> <li>2) Make sure that the R Series configuration values pertaining to the server names (FD and DH) are correct.</li> </ol>
<p><i>TRANSFER FAILED</i> <i>Full Disclosure Service Not Available</i> <i>Contact Network Administrator</i></p>	<p>The option to accept full disclosure files is not enabled on the server.</p> <p><b>Action:</b> Contact the Network Administrator for assistance.</p>
<p><i>TRANSFER FAILED</i> <i>Defib History Service Not Available</i> <i>Contact Network Administrator</i></p>	<p>The option to accept Defib History files is not enabled on the server.</p> <p><b>Action:</b> Contact the Network Administrator for assistance.</p>

*Transferring Device Check and Activity Log Files Through Wi-Fi (R Series Plus Only)*

---

<p><i>TRANSFER FAILED</i>  <i>Server Rejection</i>  <i>Contact Network Administrator</i></p>	<p>The server rejected the unit's request.  <b>Action:</b> Contact the Network Administrator for assistance.</p>
<p><i>TRANSFER FAILED</i>  <i>Unsupported Wi-Fi Card</i>  <i>Verify Installation of Wi-Fi Card</i></p>	<p>The card installed in the CF slot is not an R Series Data COMM or Data COMM II card.  <b>Action:</b> Make sure that the correct Wi-Fi card is properly installed in the unit.</p>
<p><i>TRANSFER FAILED</i>  <i>Unsupposed Wi-Fi Card</i>  <i>Update Wi-Fi Card</i></p>	<p>The card installed in the CF slot is an incorrect version. (Data COMM II only)  <b>Action:</b> Install a Data COMM II card that is the latest version.</p>
<p><i>TRANSFER FAILED</i>  <i>Authentication Error</i></p>	<p>The encryption passphrase/key is incorrect.  <b>Action:</b> Contact the Network Administrator for assistance.</p>
<p><i>TRANSFER FAILED</i>  <i>Invalid Certificate</i>  <i>Contact Network Administrator</i></p>	<p>Could not associate to an SSID using WPA/WPA2 Enterprise security because one or more of the certificates is invalid or expired. (Data COMM II only)  <b>Action:</b> Contact the Network Administrator for assistance.</p>
<p><i>TRANSFER FAILED</i>  <i>Invalid Credentials</i>  <i>Contact Network Administrator</i></p>	<p>Could not associate to an SSID using WPA/WPA2 Enterprise security because one or more of the credentials were invalid. (Data COMM II only)  <b>Action:</b> Contact the Network Administrator for assistance.</p>



# Chapter 13

## Maintenance

---

Defibrillator equipment must be maintained to be ready for immediate use. The defibrillator should be tested daily. The R Series defibrillator gives you two readiness testing options:

- Automatic
- Manual

**Note:** Both automatic and manual test results are automatically recorded to internal memory.

Maintenance Frequency	
Visual Inspection	Once per day, inspect Code Readiness indicator.
Code Readiness Test (Automatic)	Once per day, unless configured Off, in which case, perform manual defibrillator testing daily.
Manual Defibrillator Testing	Once per week; daily if Code Readiness Test is configured Off.

When the R Series device ships from ZOLL, the Code Readiness indicator may show a red “X.” A manual readiness test should be performed (in addition to other site-specific tests such as HiPot and Leakage) prior to putting the device into service. Follow the procedure on page 12-3, and verify that the Code Readiness indicator displays a green “✓.”

# Routine Procedures

## Daily Visual Inspection

### Equipment

Ensure that the unit is clean (with no fluid spills) and free of visible damage.

Inspect all cables, cords, and connectors for good condition (no cuts, fraying or bent pins).

Check that the paddle surfaces are clean and free of electrolyte gel and other contaminants.

### Supplies and Accessories

Verify the presence, proper condition and quantity of all disposable supplies (such as ECG monitoring electrodes, electrode gel, stripchart paper, alcohol swabs, razors, and antiperspirant).

Ensure that two sets of ZOLL therapy pads are available in sealed packages. Check the expiration date on all ZOLL therapy pad packages.

### Batteries/External Power Supply

Check that a fully charged battery pack is installed in the unit.

Check that a fully charged spare battery pack accompanies the unit, or that the unit has ready access to a local AC mains power outlet.

### Code Readiness Status

Look at the ✓/x Code Readiness indicator on the R Series defibrillator. If the Code Readiness indicator displays a red “X” the unit is not ready for therapeutic use.

Should the automatic Code Readiness test fail, the R Series unit sets its Code Readiness indicator to a red “X”. If the failed unit is connected to AC power, it will also display a Code Readiness status report highlighting the defibrillator functions or accessories that are compromised. If the failed unit is not connected to AC power, only the red “X” will display. Connect the unit to AC power. Turn the unit **ON**, press the **Manual Mode** softkey and then the **Confirm** softkey to enter the Manual mode of operation. Press the **Report** softkey, then the **Test Log** softkey to determine the problem. Readiness test reports can be displayed and printed as described in “Code Readiness Log” on page 13-7.

Take corrective actions (for example, replace electrodes), or remove the unit from service, and consult “Troubleshooting” on page 14-1.

While a red “X” indicates the unit is not ready for therapeutic use, the device will not prevent a user from attempting to deliver therapy. An example of a condition in which therapy delivery may still be possible is when expired electrodes are connected to the device.

## Code Readiness Test

The R Series defibrillator performs Code Readiness tests automatically to verify its integrity and readiness for emergency use. These tests verify the following:

- Battery — Verifies that the battery state of charge is sufficient for at least one hour of continuous monitoring and ten shocks at maximum energy.
- Therapy Electrodes— Verifies that OneStep Pacing, CPR, or Complete electrodes are attached to the unit and have not expired.

**Note:** The Code Readiness system automatically verifies the integrity of the specific electrodes listed above. Other electrodes (including members of the OneStep family) should be verified manually for connection, condition, and expiration date.

- ECG circuitry — Verifies that the ECG signal acquisition and processing electronics are functional.
- Defibrillator charge and discharge circuitry — Verifies that the defibrillator electronics are functional and can charge and discharge at 30 joules through the patient cable and into paddles, OneStep electrodes, or the Test Port.
- Microprocessor hardware and software — Verifies the proper function of the microprocessor electronics and the integrity of software.
- CPR circuitry and sensor — Verifies that the Real CPR Help circuits are functional (when OneStep CPR or Complete electrodes are attached).

To prepare for Code Readiness tests, do the following:

1. Connect the R Series to AC mains.
2. Do one of the following:
  - Connect unopened OneStep electrodes to the OneStep cable, (Unopened OneStep electrodes act as a test port. The test port capability no longer functions once the electrode package is opened and electrodes are deployed.)
  - Connect the OneStep cable to paddles, and seat the paddles in the paddle wells, (Verify adult paddles are installed and pushed all the way into the paddle wells.)or
  - Connect the OneStep cable to the test port.

After the successful completion of the readiness check, the Code Readiness indicator displays a green check, indicating that the unit is ready for therapeutic use. If configured, the R Series will print a test record following automatic test completion.

The unit performs an automatic device check, if configured to do so, once per day at the configured time. For information, refer to the *R Series Configuration Guide*.

## Manual Defibrillator Testing

The following test performs:

- Power-on sequence check.
- **SHOCK** button and delivered energy check.
- Pacer check.
- Recorder check.

If a *LOW BATTERY* message appears during testing, the battery is close to depletion and should be replaced or recharged.

### Before you begin

1. Connect the R Series to AC mains.
2. Do one of the following:
  - Connect unopened OneStep electrodes to the OneStep cable, (Unopened OneStep electrodes act as a test port. The test port capability no longer functions once the electrode package is opened and electrodes are deployed.)
  - Connect the OneStep cable to paddles, and seat the paddles in the paddle wells, (Verify adult paddles are installed and pushed all the way into the paddle wells.)or
  - Connect the OneStep cable to the test port.

Follow the instructions in either the next section, “Procedure for Testing with Paddles,” or in “Defibrillator Testing with Hands-Free Therapy Electrodes” on page 13-5.

## Defibrillator Testing with Paddles

---

**WARNING!** When performing this check, use your thumbs to operate the **SHOCK** buttons in order to avoid inadvertent shock. No portion of the hand should be near the paddle electrode plates.

---

To test the manual defibrillation function using paddles:

1. Turn the unit off for at least 10 seconds.
2. Turn the Mode Selector to **ON**.
3. Press the **Manual Mode** softkey.

**Note:** If the *CONFIRM MANUAL MODE* message displays, press the **Confirm** softkey to enter the Manual mode of operation.

The unit emits a four-beep tone indicating successful completion of the power-on self-test. The ECG source is PADDLES, and ECG size is X1. “*DEFIB 120J SEL*” appears on the display. The ECG trace appears as a solid line while the paddles are seated in the paddle wells.

4. Press the **ENERGY SELECT** buttons to set the energy to 30 joules.
5. Press the **CHARGE** button on the apex handle.
6. When the charge-ready tone sounds, press the **ENERGY SELECT** buttons to change the selected energy to 20 joules.

The defibrillator will disarm itself.

7. Press the **ENERGY SELECT** buttons to reset the energy to 30 joules.

**Note:** For testing, the unit discharges the defibrillator only if the energy is set to 30 joules.

8. Press the **CHARGE** button.

When the charge-ready tone sounds, the message *DEFIB 30J READY* appears.



9. Press paddles firmly into their wells and using your thumbs, simultaneously press and hold the **SHOCK** buttons (one on each paddle) until the shock is delivered.

The unit displays the message *30J TEST OK* and prints a stripchart indicating *30J TEST OK* and the delivered energy.

If the message *30J TEST FAILED* appears, contact appropriate technical personnel or the ZOLL Technical Service Department.

## Defibrillator Testing with Hands-Free Therapy Electrodes

To test the manual defibrillation function using hands-free therapy electrodes:

1. Turn the unit off for at least 10 seconds.
2. Turn the Mode Selector to **ON**.
3. Press the **Manual Mode** softkey.

**Note:** If the *CONFIRM MANUAL MODE* message displays, press the **Confirm** softkey to enter the Manual mode of operation.

The unit emits a four-beep tone indicating successful completion of the power-on self-test. The ECG source is PADS, and ECG size is X1. “DEFIB 120J SEL,” and *DEFIB PAD SHORT* appear on the display. The ECG trace appears as a solid line while the OneStep cable is connected to either the Test Port or OneStep electrodes.

4. Press the **ENERGY SELECT** buttons to set the energy to 30 joules.
5. Press the **CHARGE** button on the front panel.
6. When the charge-ready tone sounds, press the **ENERGY SELECT** buttons to set the energy to 20 joules.

The defibrillator will disarm itself.

7. Press the **ENERGY SELECT** buttons to reset the energy to 30 joules

**Note:** For testing, the unit discharges the defibrillator only if the energy is set to 30 joules.

8. Press the **CHARGE** button on the front panel.
9. When the Ready tone sounds, press the **SHOCK** button on the front panel until the shock is delivered.

The unit displays the message *30J TEST OK* and prints a stripchart indicating *30J TEST OK* and the delivered energy.

If the message *30J TEST FAILED* appears, contact appropriate technical personnel or the ZOLL Technical Service Department.

A manual defibrillation test can be done in AED mode only if the Code Readiness indicator shows a red “X” and the OneStep cable is connected to either unopened OneStep electrodes or the test port.

To test the defibrillation function in AED mode using hands-free therapy electrodes:

1. Turn the unit off for at least 10 seconds.
2. Turn the Mode Selector to **On**.

The unit emits a four-beep tone indicating completion of the power-on self-test, displays **CHECK PADS**, and issues the voice prompt. The ECG trace appears as a solid line while the OneStep cable is connected to either the Test Port or OneStep electrodes.

3. Press the **Manual Test** softkey. The unit charges to 30 joules.

4. When the Ready tone sounds, press the **SHOCK** button on the front panel until the shock is delivered.


The unit displays the message *30J TEST OK* and displays a shock count of 1.

If the message *30J TEST FAILED* appears, contact appropriate technical personnel or the ZOLL Technical Service Department.

## Pacer Testing

1. Turn the Mode Selector to **ON**.
2. Press the **Manual Mode** softkey.

**Note:** If the *CONFIRM MANUAL MODE* message displays, press the **Confirm** softkey to enter the Manual mode of operation.

3. Turn the Mode Selector to **PACER**.
4. Turn the **PACER RATE** control to 150 ppm, then press the **RECORDER** button.  
On the stripchart, verify that pacing stimulus markers (  ) occur approximately every centimeter (10 small divisions or 2 large divisions).
5. Press and hold the **4:1** button.  
The frequency of the pacing stimulus markers decreases, occurring approximately every 4 centimeters (40 small divisions or 8 large divisions).
6. Turn the **PACER OUTPUT** control to 0 mA.  
There should be no *CHECK PADS* or *POOR PAD CONTACT* messages.
7. Disconnect the OneStep cable from the test port or OneStep electrodes, and slowly turn the **PACER OUTPUT** control to 16 mA or more.  
The messages *CHECK PADS* and *POOR PAD CONTACT* appear alternately. The pace alarm sounds, and the **Clear Pace Alarm** softkey flashes.
8. Reconnect the OneStep cable, and press the **Clear Pace Alarm** softkey.  
The messages *CHECK PADS* and *POOR PAD CONTACT* disappear, and the alarm tone stops.

## Recorder Check

1. Turn the Mode Selector to **ON**.
2. Press the **Manual Mode** softkey.  
**Note:** If the *CONFIRM MANUAL MODE* message displays, press the **Confirm** softkey to enter the Manual mode of operation.
3. Select the ECG lead.
4. Check the printer for an adequate supply of paper, then press the **RECORDER** button.
5. Press and hold the **SIZE** button for at least 2 seconds.  
A calibration pulse of 1 mV appears on the display while the button is held. The amplitude of the calibration pulse is independent of the **SIZE** setting.
6. Inspect the recorder waveform for uniformity and darkness.
7. Inspect for uniformity of annotated characters and completeness of words.
8. Check the printer speed by verifying that the resulting waveform is:
  - 2.5 mm  $\pm$ 0.5 mm wide

- 10 mm  $\pm$ 1.0 mm high

## Code Readiness Log

Each automatic and manual defibrillation test result is stored in internal non-volatile memory, the Code Log. A total of 1000 Code Readiness test records can be stored in internal memory. When the Code Readiness Log is full, the oldest records are erased on a first-in-first-out (FIFO) basis.

The Code Readiness Log can be transferred to an external computing device (see “Transferring Files to an External Device” on page 12-1).

If configured, the R Series prints a Code Readiness Test Report following the completion of each automatic defibrillator test.

To print the Code Readiness Log:

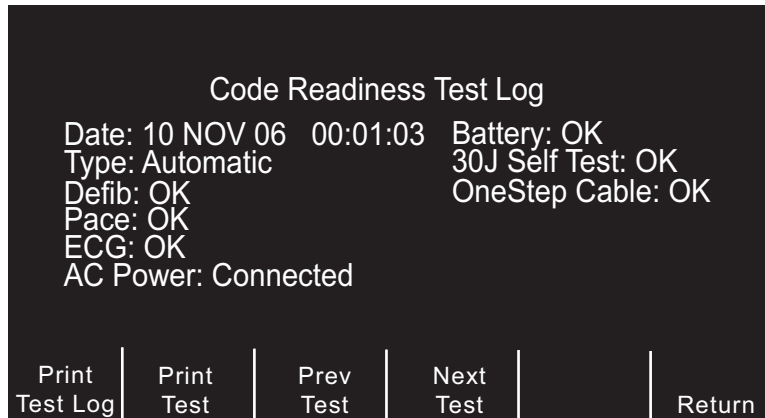
1. Turn the Mode Selector to **ON**.
2. Press the **Manual Mode** softkey.

**Note:** If the *CONFIRM MANUAL MODE* message displays, press the **Confirm** softkey to enter the Manual mode of operation.

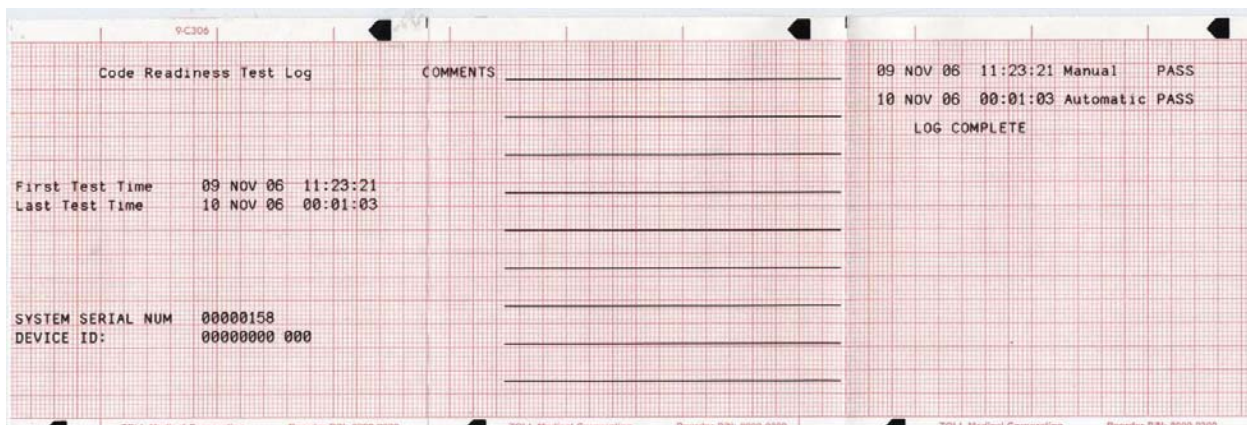
3. Press the **Report Data** softkey.
4. Press the **Test Log** softkey.

A menu appears with the print options.

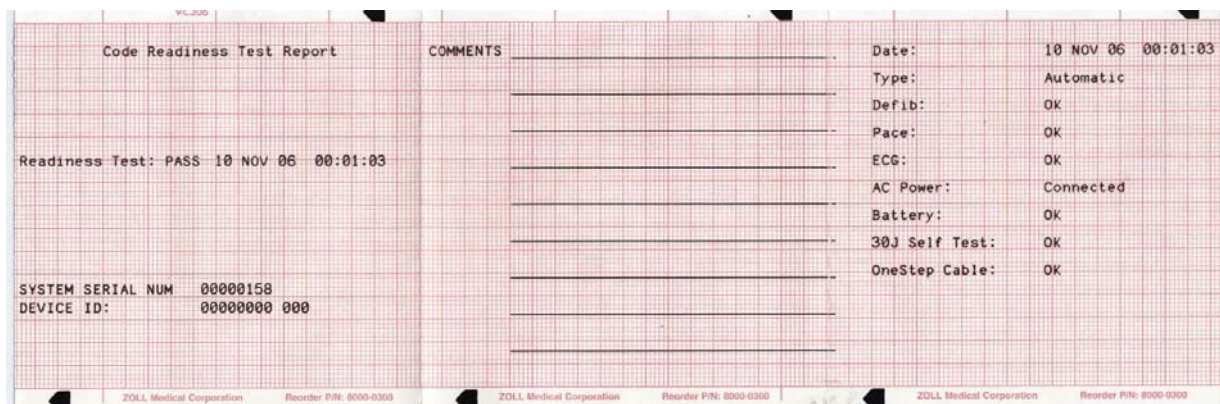
- To print a specific test, use the **Prev Test** and **Next Test** softkeys to select the test, then press **Print Test**, or press **Print Test Log** to print the log of all of the tests.



**Figure 13-1. Code Readiness Test Log Print Display**



**Figure 13-2. Code Readiness Test Log**



**Figure 13-3. Code Readiness Test Report**

## Setting Time and Date

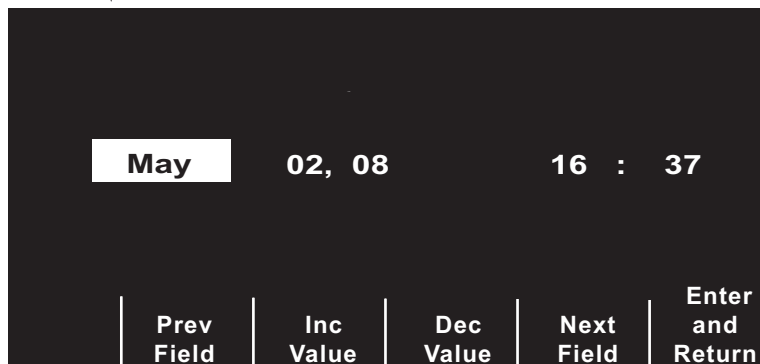
To set the unit's time and date:

1. Turn the Mode Selector to **ON**.
2. Press the **Manual Mode** softkey.

**Note:** If the *CONFIRM MANUAL MODE* message displays, press the **Confirm** softkey to enter the Manual mode of operation.

3. Press the **Options** softkey.
4. Press **More**.
5. Press **Set Clock**.

The month field will be highlighted.



**Figure 13-4. Set Time Screen**

6. Press the **Inc Value** or **Dec Value** softkeys to select the appropriate month.
7. Press the **Next Field** softkey to set the selected month, and move the highlight to the next field (day).
8. Repeat steps 5 and 6 to set the correct day, year, hours, and minutes values.

**Note:** The last field does not automatically scroll (wrap) to the beginning. You must press the **Prev Field** softkey to enter the values for the previous field. If you need to make corrections, press the **Prev Field** softkey to move the highlight to the field previously entered.

9. Press the **Enter and Return** softkey to set all values and return to normal monitoring mode.

**Note:** The R Series unit may be configured to synchronize the time automatically with a data server in the Wi-Fi Data Transfer configuration settings. See the *R Series Configuration Guide* for more information.

## Cleaning the R Series Unit

R Series products and accessories are chemically resistant to most common cleaning solutions and noncaustic detergents. The following cleaning solutions are approved:

- 90% isopropyl alcohol (except on adapters, patient cable and Wi-Fi Data COMM Card)
- Soap and water
- Chlorine bleach solution of 30 milliliters per liter of water (except on Sync In/Marker Out connector and battery compartment pins)

ZOLL recommends cleaning the device, paddles, and cables with a soft damp cloth using the approved cleaning agents. The external printer parts should be cleaned with a damp, soft cloth only.

Do not immerse any part of the defibrillator (or its accessories) in water. Do not use ketones (such as acetone or MEK) on the defibrillator. Do not sterilize the defibrillator. Avoid using abrasives (including paper towels) on the display window.

Take special care to clean the defibrillation paddles after each use. The buildup of gel can interfere with ECG monitoring through the paddles, can adversely effect energy delivery and may reduce operator safety. Keep the paddle handles clean as well.

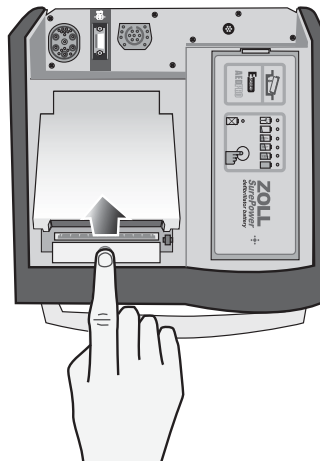
## Loading Stripchart Paper

The unit displays the message *CHECK RECORDER* when the printer is activated without paper or if the supply runs out during printing.

Use ZOLL stripchart paper (Part number 8000-0300).

To load paper into the stripchart printer:

1. Press the release button and allow the printer door to open, then remove any paper.

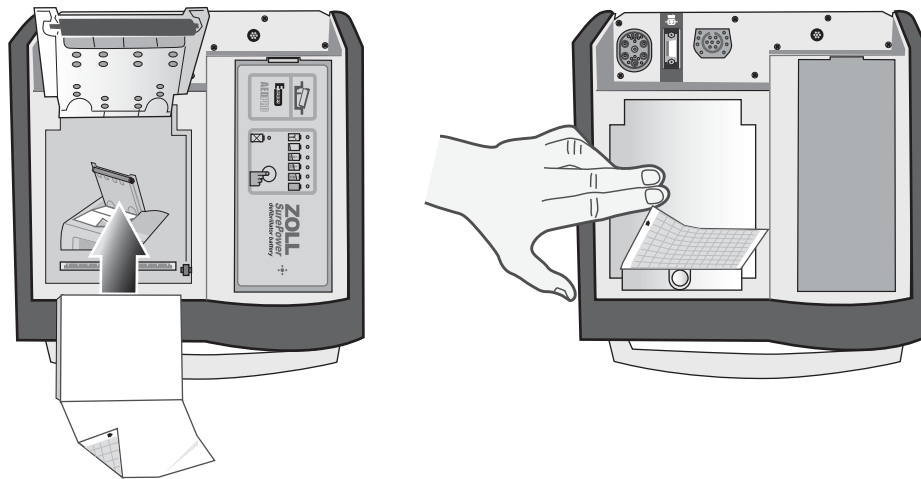


**Figure 13-5. Opening the Printer Door**

2. Refer to the illustration inside of the paper compartment for proper paper orientation, and place a new pad of stripchart paper in the tray.

**Note:** Paper feeds from the top of the stack with gridlines facing down.

3. Pull enough paper off the pad so that paper extends out of the unit when the printer cover is closed.
4. Close the printer cover by pressing down lightly on the edge of the cover next to the release button. Be sure the cover is flush with the top of the device.



**Figure 13-6. Inserting the Paper and Closing Printer Door**

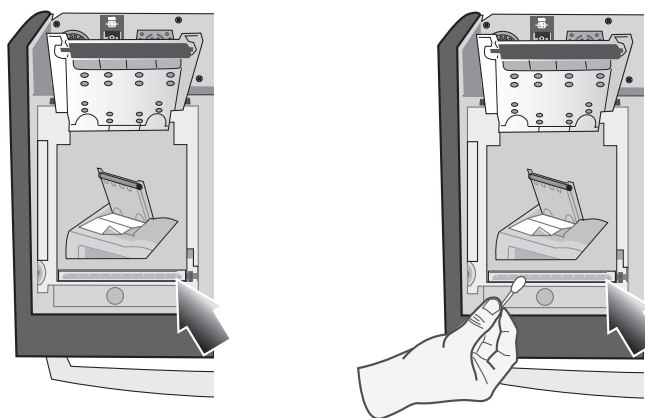
After the paper is loaded, press the **RECORDER** button to resume printing.

**Note:** To ensure you have loaded the paper properly, check to make sure the arrows printed on the red, grid side of the paper point upward.

## Cleaning the Print Head

To clean the recorder print head, perform the following steps:

1. Press the release button, and allow the printer door to open (see Figure 13-5); then remove any paper.
2. Locate the printhead along the front floor of the printer compartment, just below the release button.
3. Gently wipe the printhead with a cotton swab moistened with isopropyl alcohol, and dry any residual alcohol with another dry cotton swab.



**Figure 13-7. Cleaning the Print Head**

4. Place the paper back into the unit and close the cover (see Figure 13-6).

# Operator's Checklist for R Series Product

Recommended checks and procedures to be performed daily or weekly, depending on Automatic Test configuration.

Date \_\_\_\_\_

Location \_\_\_\_\_

Unit Serial Number \_\_\_\_\_

1. Condition	Remarks
Unit clean, no spills, clear of objects on top, case intact	
<b>2. Hands-free Therapy electrodes</b>	
1 set preconnected / 1 spare	
<b>3. Paddles</b>	
Paddles clean, not pitted	
Release from housing easily	
<b>4. Inspect cables for cracks, broken wires, connector</b>	
A ECG electrode cable, connector	
B Defibrillator paddle cables	
C OneStep cable, connector	
D Other patient cables	
<b>5. Batteries/External power supply</b>	
A Fully charged battery in unit	
B Fully charged spare battery available, or ready access to local AC mains	
<b>6. Disposable supplies</b>	
A Defib gel or gel patches	
B Hands-free therapy electrodes in <b>sealed</b> packages — 2 sets	
C ECG electrodes	
D Recorder paper	
E Alcohol wipes	
F Razors	
<b>7. Operational checks</b>	
<b>A Power On Sequence</b>	
Turn unit to ON, 4-beep tone heard, AED label and ON Mode Selector light up	
Press Manual Mode softkey, press Confirm softkey, front panel lights up	
ECG size X 1	
"PADDLES" or "PADS" as lead selected	
<b>B Paddles</b>	
Paddles in holder: Set defib energy level to 30 joules, press paddles firmly into the side wells, and simultaneously press and hold both defib discharge buttons; "30J TEST OK" message on Recorder.	
<b>C Defibrillator</b>	
OneStep cable connected to test connector, or OneStep electrodes. Set defib energy level to 30 joules, press <b>SHOCK</b> button; "30J TEST OK" message on Recorder	
<b>D Pacer Operation (If installed)</b>	
OneStep cable not connected to Test Connector or OneStep electrodes	
Turn to PACER, set pacer rate to 150 ppm, press <b>RECORDER</b> button	
Pacer pulses occur ever 2 large divisions (10 small divisions)	
Press <b>4:1</b> button, pulses occur every 8 large divisions	
Set PACER OUTPUT to 0 mA, no <b>CHECK PADS</b> message	
Set PACER OUTPUT to 16 mA, <b>CHECK PADS</b> message and alarm	
Reconnect OneStep cable to test connector, or OneStep electrodes. Press <b>Clear Pace Alarm</b> softkey; <b>CHECK PADS</b> message disappears and Pace alarm stops.	
<b>E Recorder</b>	
Press <b>RECORDER</b> button; Recorder runs. Press again; Recorder stops.	
Inspect Recorder printing	
<b>8. Please check the appropriate box after each use of this checklist.</b>	<b>Signature</b>
<b>No action required</b>	_____
<b>Minor problem(s) corrected</b>	
<b>Disposable supplies replaced</b>	
<b>Major problem(s) identified — UNIT OUT OF SERVICE</b>	



# Chapter 14

## Troubleshooting

---

The troubleshooting information provided in this chapter is intended for use by nontechnical medical personnel during device operation. This chapter answers many of the common problems or questions that may arise during operation.

If trouble persists after consulting this guide, contact the appropriate technical personnel or ZOLL Technical Service Department. Refer to the *R Series Plus/BLS Service Manual* for more detailed troubleshooting information.

### Code-Ready

Symptom	Recommended Action
1. Code Readiness indicator displays a red "X" while unit is turned off.	Turn the unit on. Print Code Readiness log as described on page 13-7. Follow messages and prompts to resolve the problem.
2. Code Readiness indicator displays a red "X" while unit is powered on.	Turn the unit off and then on again. Follow messages and prompts to resolve the problem.  Perform a Manual Defibrillator test as described in "Manual Defibrillator Testing" on page 13-3.  If the unit continues to fail, take it out of service and contact ZOLL Technical Service.

Symptom	Recommended Action
3. Pad Expired; Replace Pads	Check the expiration date on OneStep electrodes, and replace them if they are expired.
4. Poor Pad Condition; Replace Pads	OneStep electrode condition sensor indicates that the electrode gel has dried or aged beyond its specifications. The electrodes may no longer provide optimal therapy. Replace therapy electrodes. (If emergency defibrillation is required and spare hands-free therapy electrodes or paddles are not immediately available, it may be advisable to use the pads in question rather than delay therapy.)

## Monitor


Symptom	Recommended Action
1. Unit does not turn on or unexpectedly shuts off.	<ul style="list-style-type: none"> <li>• Check that battery pack is properly installed.</li> <li>• Verify the unit is plugged into AC power.</li> <li>• Replace battery pack with a fully charged battery pack.</li> </ul>
2. <i>X FAULT XX</i> message	<ul style="list-style-type: none"> <li>• A fault has been detected.</li> <li>• Attempt to clear the <i>X FAULT XX</i> message by turning the Mode Selector to <b>OFF</b> for more than 10 seconds, then back to the desired operating mode.</li> </ul> <p><b>Note:</b> Some settings (e.g. alarm settings, lead selection, ECG size) may need to be restored.</p>
3. <i>SET CLOCK</i> message	<ul style="list-style-type: none"> <li>• Set time and date information.</li> <li>• Verify that the internal lithium battery has been replaced within the last 5 years. Contact ZOLL Technical Service Department for assistance</li> </ul>
4. <i>ECG LEAD OFF</i> message	<ul style="list-style-type: none"> <li>• Check that ECG cable or OneStep Pacing cable is connected to patient and instrument.</li> <li>• Check that ECG electrodes or OneStep Pacing or Complete electrodes are making good contact and are not dried out.</li> <li>• If changing from 5-lead ECG patient cable to 3-lead ECG patient cable, remove the 5 lead cable then turn unit <b>OFF</b> for at least 10 seconds.</li> <li>• Replace ECG cable or OneStep cable.</li> </ul>
5. <i>POOR LEAD CONTACT</i> message	<ul style="list-style-type: none"> <li>• Check that ECG cable or OneStep Pacing cable is connected to patient and instrument.</li> <li>• Check that ECG electrodes or OneStep Pacing or Complete electrodes are making good contact and are not dried out.</li> <li>• If changing from 5-lead ECG patient cable to 3-lead ECG patient cable, remove the 5 lead cable then turn unit <b>OFF</b> for at least 10 seconds.</li> <li>• Replace ECG cable or OneStep cable.</li> </ul>

Symptom	Recommended Action
6. Noisy ECG, artifact, wandering baseline	<ul style="list-style-type: none"> <li>• Consider 1 – 21Hz filter bandwidth (see <i>R Series Configuration Manual</i>).</li> <li>• Prepare the patient's skin prior to electrode attachment.</li> <li>• Check for proper adhesion of electrodes to patient.</li> <li>• Reduce or eliminate ECG artifact due to electrode or patient cable movement. Route cables so that they don't pull on electrodes or swing excessively.</li> <li>• Ensure patient is motionless.</li> <li>• Check for possible excessive radio frequency interference.</li> </ul>
7. Poor ECG signal amplitude, calibration pulse normal	<ul style="list-style-type: none"> <li>• Select another lead.</li> <li>• Apply new electrodes using different placement.</li> </ul>
8. Inconsistent QRS beep or heart rate	<ul style="list-style-type: none"> <li>• Select another lead.</li> <li>• Alter ECG electrode placement.</li> </ul>
9. Sync marker is absent or inconsistent with QRS waveform on display and recorder	<ul style="list-style-type: none"> <li>• Ensure device is in Sync mode.</li> <li>• Ensure that device is NOT in Remote Sync mode.</li> <li>• Change ECG lead selection.</li> <li>• Alter ECG electrode placement.</li> <li>• Paper too narrow. It should be 90 mm wide.</li> </ul>
10. No ECG trace or dashed line on display	<ul style="list-style-type: none"> <li>• Device is in Remote Sync mode. Press the <b>Sync On/Off</b> softkey to exit Remote Sync mode.</li> </ul>
11. CPR Remaining Timer is enabled but fails to decrement	<ul style="list-style-type: none"> <li>• Turn unit off for 10 seconds and then turn it back on again.</li> </ul>
12. Alarm tone sounds when unit is turned on but alarm feature is not enabled	<ul style="list-style-type: none"> <li>• Press the <b>ALARM SUSPEND</b> button.</li> </ul>

## Recorder

Symptom	Recommended Action
1. <i>CHECK RECORDER</i> message	<ul style="list-style-type: none"> <li>Recorder out of paper.</li> <li>Remove paper, check paper type, check recorder for paper jam, and reload paper.</li> <li>Recorder door is open.</li> <li>Paper is loaded upside down.</li> </ul>
2. Recorder makes stuttering sound when activated.	<ul style="list-style-type: none"> <li>Check recorder for paper jam.</li> </ul>
3. Light or poor quality printing	<ul style="list-style-type: none"> <li>Ensure correct paper is in use.</li> <li>Ensure paper is installed grid side against recorder print head.</li> <li>Recorder print head requires cleaning.</li> </ul>
4. Summary Report will not print when <b>Report/Print Chart</b> softkeys are activated.	<ul style="list-style-type: none"> <li>15 seconds have <b>not</b> elapsed since one of the events that trigger Summary Report to record have occurred. Wait 15 seconds, then try again.</li> </ul>

## Pacer

Symptom	Recommended Action
1. <i>CHECK PADS</i> message	<ul style="list-style-type: none"> <li>Ensure therapy electrodes are connected to the OneStep cable.</li> <li>Ensure electrode gel is not dry. Replace therapy electrodes if necessary.</li> <li>Ensure good electrode-to-patient contact.</li> <li>Check integrity of OneStep cable by plugging into test connector. <i>CHECK PADS</i> should disappear.</li> <li>Ensure electro-surgical apparatus is not active.</li> </ul>
2. No stimulus marker (  ) is present on the ECG trace.	<ul style="list-style-type: none"> <li>Ensure unit is in <b>PACER</b> mode.</li> <li>Ensure <b>PACER RATE</b> (ppm) is set greater than patient heart rate.</li> </ul>
3. No ventricular capture beat appears after stimulus marker on ECG display.	<ul style="list-style-type: none"> <li>Check patient's pulse.</li> <li>Increase output current.</li> <li>Ensure therapy electrodes are making good contact with the patient.</li> <li>Select different ECG Lead configuration.</li> <li>Review therapy electrode placement.</li> </ul>

Symptom	Recommended Action
4. Patient on "Standby" pacing gets paced intermittently.	<ul style="list-style-type: none"> <li>• Ensure proper ECG electrode or OneStep Pacing/ Complete electrode connection and placement. If ECG lead wire comes off, pacer will automatically pace asynchronously.</li> <li>• Check ECG cable for damage.</li> <li>• Patient R-to-R interval varying. Pace rate close to patient's heart rate.</li> <li>• Verify rate is set appropriately.</li> </ul>
5. Heart rate display reads 0 with proper pacing capture displayed on ECG trace.	<ul style="list-style-type: none"> <li>• Check patient's pulse.</li> <li>• Select different ECG Lead configuration.</li> </ul>
6. Bedside/Central Station/Telemetry ECG display becomes erratic when pacing.	None, the patient monitor ECG inputs are overloaded by pacer signals. ECG can only be monitored by the R Series or pacing device while pacing.

## Defibrillator

Symptom	Recommended Action
1. Excessive artifact detected when using paddles as ECG source.	<ul style="list-style-type: none"> <li>• Ensure "PADDLES" is selected.</li> <li>• Firmly press paddles against patient skin.</li> <li>• Use gel on paddles.</li> <li>• Clean paddle surface.</li> <li>• Check and clean between adult and pediatric plate.</li> <li>• Check cable for damage.</li> <li>• Use ECG electrodes.</li> </ul>
2. Defibrillator will not charge (energy level does not increment on display).	<ul style="list-style-type: none"> <li>• Ensure that <b>SHOCK</b> button(s) on paddles or front panel are not stuck on.</li> <li>• Replace the battery pack.</li> </ul>
3. Charge time to 200 J exceeds 10 seconds.	<ul style="list-style-type: none"> <li>• Typical in a low battery condition (up to 20 seconds)</li> <li>• Plug device into AC power.</li> <li>• Install fully charged battery pack.</li> </ul>

Symptom	Recommended Action
4. Energy does not discharge when the <b>SHOCK</b> button(s) is pressed.	<ul style="list-style-type: none"> <li>• 60 or 120 seconds (user configurable) have elapsed in Manual mode since initial charge ready. Energy was internally discharged.</li> <li>• Device is in Sync mode or Remote Sync mode and no QRS complex is detected.</li> <li>• Energy internally discharged because energy selection was changed during charge or after the device was ready.</li> <li>• Unit was not completely charged when <b>SHOCK</b> button(s) were pressed. Wait for <i>DEFIB XXXJ READY</i> message and ready tone.</li> <li>• Press and hold <b>SHOCK</b> button(s) until energy is delivered to the patient.</li> <li>• Pads or paddles not making good contact with patient.</li> </ul>
5. Unable to <b>SHOCK</b> when in Sync mode	<ul style="list-style-type: none"> <li>• Ensure <i>SYNC XXXJ SEL</i> is displayed on monitor.</li> <li>• Make sure ECG signals are displayed.</li> <li>• Check for Sync markers (arrow above R wave). If not present, change lead selection, or electrode placement.</li> <li>• Press and hold <b>SHOCK</b> button(s) until energy is delivered to the patient.</li> <li>• Alter ECG electrode placement.</li> </ul>
6. Unable to <b>SHOCK</b> when in Remote Sync mode	<ul style="list-style-type: none"> <li>• Ensure <i>REMOTE SYNC</i> is displayed in place of the ECG waveform and that <i>REMOTE SYNC XXXJ SEL</i> is displayed.</li> <li>• Ensure that a remote device conforming with the Sync In/Marker Out specifications in Appendix A is properly connected.</li> <li>• Ensure that Sync markers appear with each R-wave on the remote device's display. If Sync markers are not present on the remote device's display or do not appear to be nearly simultaneous with each R-wave, do not proceed with synchronized cardioversion.</li> <li>• Press and hold <b>SHOCK</b> button(s) until energy is delivered to the patient.</li> </ul>
7. No apparent energy delivery to patient	<ul style="list-style-type: none"> <li>• Under certain circumstances, some patients will not show a physical reaction when energy is delivered.</li> <li>• Perform defibrillator self-test.</li> <li>• Check for <i>CHECK PADS</i> and <i>POOR PAD CONTACT</i> messages alternating on the monitor.</li> <li>• If hands-free therapy electrodes are used, ensure proper placement and contact.</li> <li>• Review the discharge stripchart for Joules/current delivered.</li> </ul>

Symptom	Recommended Action
8. <i>CHECK PADS</i> or <i>ATTACH PADS</i> message	<ul style="list-style-type: none"> <li>• Verify proper OneStep cable / hands-free therapy electrode connection by disconnecting and reconnecting the OneStep cable and hands-free therapy electrodes.</li> <li>• Ensure proper contact of hands-free therapy electrodes and that the patient does not have excessive hair beneath the electrodes.</li> <li>• OneStep cable is defective. If message persists, disconnect OneStep cable from therapy pads, and plug cable into test connector. <i>CHECK PADS</i> or <i>ATTACH PADS</i> should change to <i>DEFIB PAD SHORT</i> (Manual mode only).</li> <li>• Try using paddles to defibrillate.</li> <li>• Ensure electrosurgical apparatus is not active.</li> </ul>
9. <i>SELECT PADS</i> message	<ul style="list-style-type: none"> <li>• ECG Analysis will operate only when hands-free therapy electrodes are attached to the patient.</li> <li>• Disconnect paddle, and connect hands-free therapy electrodes for use in Advisory defibrillation.</li> <li>• Activate Manual mode to use Paddles.</li> </ul>
10. <i>NOISY ECG RETRY ANALYSIS</i> message	<ul style="list-style-type: none"> <li>• Check for proper application and adhesion of hands-free therapy electrodes.</li> <li>• Check to make sure that nobody is touching the patient and that the patient is motionless.</li> </ul>
11. No 30J <i>TEST OK</i> message is displayed when performing a manual defibrillator self-test.	<ul style="list-style-type: none"> <li>• Check to make sure unit is set to 30 joules.</li> <li>• If testing with OneStep electrodes, make sure that the OneStep cable patient connector is firmly inserted into the electrode connector. Ensure the OneStep electrode package is sealed.</li> <li>• If testing with the Test Port, make sure the OneStep cable is firmly inserted into the Test Port.</li> <li>• If testing with paddles, make sure to press the paddles firmly into the paddle wells while discharging.</li> </ul>
12. <i>DEFIB MAINT. REQ.</i> message	<ul style="list-style-type: none"> <li>• Indicates that the device has delivered 5000 shocks at the maximum energy of 200 joules. Only 200 joule shocks are counted. The device is still usable; if you are responding to a code, continue using the device. Contact ZOLL Technical Service Department when possible.</li> </ul>

## AC Charger

Symptom	Recommended Action
1. The Battery indicator is alternately illuminating green and yellow.	<ul style="list-style-type: none"> <li>• Verify battery is installed.</li> <li>• Turn unit <b>ON</b> to identify the fault condition.</li> <li>• Replace battery pack with a fully charged battery pack.</li> <li>• If problem persists, replace battery pack, unplug device from AC mains for more than 10 seconds and plug device back into AC mains.</li> </ul>
2. <i>LOW BATTERY</i> message appears on monitor when unit is plugged into AC mains.	<ul style="list-style-type: none"> <li>• Verify that the AC Power Indicator is illuminated.</li> <li>• If not, check AC power cord connection at the wall outlet and at the rear of the device.</li> <li>• Replace battery pack with a fully charged battery pack.</li> <li>• Unplug device from AC mains, and plug device back into AC mains.</li> <li>• Verify AC mains is working properly.</li> </ul>
3. Neither the Battery, nor AC Power indicator is illuminated when the device is plugged into AC mains.	<ul style="list-style-type: none"> <li>• Unplug device from AC mains, and plug device back into AC mains.</li> <li>• Verify AC mains is working properly.</li> </ul>

## CPR

<i>CHECK CPR PUCK</i> message is displayed.	<ul style="list-style-type: none"> <li>• No action is required. This is an informational message to indicate that default calibration values are being used for the CPR puck. The CPR values will be within the specification.</li> </ul>
---	---



# Appendix A

# Specifications

---

This section describes the specifications for the R Series Defibrillator as well as the ECG rhythm analysis algorithm.

- “Defibrillator Specifications” on page A-2
- “Battery Pack Specifications” on page A-7
- “IEC 60601-1-2 Specifications” on page A-8
- “R Series Rectilinear Biphasic Waveform Characteristics” on page A-12
- “Clinical Trial Results for the Biphasic Waveform” on page A-24
- “ECG Rhythm Analysis Algorithm Accuracy” on page A-29

## Defibrillator Specifications

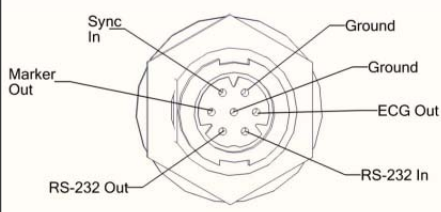
<b>General</b>	
Size (height • width • length)	8.2 in. • 10.5 in. • 12.5 in. with handle or 10.0 in. without handle 20.8 cm • 26.7 cm • 31.7 cm with handle or 25.4 cm without handle
Weight	13.6 lb (6.17 kg) with OneStep cable and battery pack 15.2 lb (6.89 kg) with paddles
Power (for R Series ALS, BLS and Plus models)	Battery: Rechargeable lithium ion battery pack  AC Power Requirements: 100-120 Vrms, 50/60 Hz 220-240 Vrms, 50 Hz AC Power Consumption: 275 VA maximum
Device classification	Class I and internally powered per EN 60601-1.
Design standards	Meets or exceeds applicable requirements of: IEC 60601-1: 2005 + CORR. 1 (2006) + CORR. 2 (2007) IEC 60601-2-4: 2010 (Third Edition) EN 61000-4-6, EN 61000-4-8, and EN 61000-4-11 as pertains to EN 60601-1-2. IEC 60601-2-27: 2011 (Third Edition) IEC 60601-2-49 (Second Edition): 2011 ISO 80601-2-55:2011 (First Edition) for use with IEC 60601-1: 2005 (Third Edition) + CORR.1 (2005) + CORR. 2 (2007) ISO 80601-2-61:2011 (First Edition) for use with IEC 60601-1: 2005 (Third Edition) + CORR.1 (2005) + CORR. 2 (2007)
Patient safety	All patient connections are electrically isolated.
<b>Environmental</b>	
Operating temperature	0°C to 40°C (32°F to 104°F)
Storage and shipping temperature	-20°C to 60°C (-4°F to 140°F)
Humidity	5% to 95% relative humidity, noncondensing
Vibration	IEC 68-2-6 and IEC 68-2-34
Shock	IEC 68-2-27, 50 g 6ms half sine
Operating pressure	594 to 1060 millibars (-1253 to 14046 ft.)
Particle and water ingress	IEC 529, IP 22

Electromagnetic compatibility (EMC)	CISPR 11 Class B - radiated and conducted emissions
Electromagnetic immunity	AAMI DF80; EN 61000-4-3 to 10 V/m
Electrostatic discharge	AAMI DF80; EN 61000-4-2
Conducted susceptibility	EN 61000-4-4, 61000-4-5, 61000-4-6
<b>Display</b>	
Screen type	High-resolution, liquid crystal display (LCD)
Screen size	6.5 inches (16.5 cm) diagonally
Display format	Nonfade moving bar display.
Sweep speed	25 mm/s
Viewing time	5 seconds 4 seconds with certain monitoring parameter options
Messages	ERASING REPORT, INSERT CARD, REPLACE BATTERY, LOW BATTERY, PERFORM CPR, NOISY ECG, RETRY ANALYSIS, CHECK PATIENT, ANALYSIS HALTED, PRESS ANALYZE, NO SHOCK ADV., SHOCK ADVISED, PRESS CHARGE, SELECT PADS, SELECT ECG LEADS, SELECT DEFIB MODE, VF ALARMS OFF, REMOVE SYNC, CHECK PADS, ATTACH PADS, POOR PAD CONTACT, DEFIB PAD SHORT, PADDLE FAULT, ECG LEAD OFF, USE PADDLE DISCHG, CANNOT CHARGE, RELEASE SHOCK, PRESS SHOCK, 30J TEST OK, TEST FAILED, PACER DISABLED, DEFIB DISABLED, SET PACE MA, CHECK RECORDER, ANALYZING ECG, FULLY RELEASE
<b>Electrodes</b>	
Hands-free therapy electrodes	<ul style="list-style-type: none"> <li>• OneStep electrodes</li> <li>• Pro-padz</li> <li>• Stat-padz</li> <li>• Pediatric Pedi-padz®</li> </ul>
<b>Defibrillator</b>	
Waveform	Rectilinear Biphasic
Energy selection (delivered to a 50Ω load)	<ul style="list-style-type: none"> <li>• <b>ADULT:</b> 1, 2, 3, 4, 5, 6, 7 8, 9, 10, 15, 20, 30, 50, 75, 100, 120, 150, 200 joules (through front panel buttons or paddle buttons)</li> <li>• <b>PEDIATRIC:</b> 1, 2, 3, 4, 5, 6, 7 8, 9, 10, 15, 20, 30, 50, 70, 85, 100, 120, 150, 200 joules (through OneStep pediatric electrodes only)</li> </ul>

Charge Time	<ul style="list-style-type: none"> <li>• Less than 7 seconds with a new, fully charged battery (first 15 charges to 200 joules), with or without AC power at rated mains voltage.</li> <li>• For the fifteenth discharge at maximum energy, the charge time is less than 10 seconds, with or without AC power at rated mains voltage. Depleted batteries result in a longer defibrillator charge time.</li> <li>• Less than 15 seconds when operating without a battery, using AC power alone at 90% of the rated mains voltage.</li> <li>• Less than 25 seconds from the initial power on, with a new, fully charged battery pack (depleted by up to fifteen 200 Joule discharges) or when operating without a battery, using AC power alone at 90% or 100% of the rated mains voltage.</li> <li>• Less than 30 seconds from initial power on and after rhythm analysis (advisory mode) with a new, fully charged pack (depleted by up to fifteen 200 J discharges) and using AC power at 90% of rated mains voltage.</li> </ul>
Patient Impedance Range	15 - 300 ohms
Energy display	Screen shows selected and delivered energy.
Synchronized mode	Synchronizes defibrillator discharge to the patient's R wave. SYNC is indicated on the display with R wave markers above the ECG waveform on the screen and stripchart. When ECG is monitored by the device, meets the DF-80:2003 requirement of 60ms maximum time delay between the peak of the R wave and the delivery of energy.
Charge controls	<b>CHARGE</b> button on front panel and apex paddle.
Paddles	Standard apex/sternum paddles. Adult plate slides off to expose smaller plate for pediatric patients.
Automatic Defibrillator Test	Verifies defibrillator charging and discharging without removing paddles from storage wells or with OneStep cable connected to the Test Port or OneStep electrodes.
Defibrillation advisory	Evaluates electrode connection and patient ECG to determine if defibrillation is required.  Shockable rhythms: <ul style="list-style-type: none"> <li>• Ventricular fibrillation (VF) with amplitude &gt; 100 <math>\mu</math>V</li> <li>• Wide-complex ventricular tachycardia (VT) with rates greater than 150 beats per minute (adult), or 200 beats per minute (pediatric).</li> </ul> Refer to "ECG Rhythm Analysis Algorithm Accuracy" on page A-29 for sensitivity and specificity performance.
<b>CPR Monitoring</b>	
Compression depth	0.75 to 3 inches $\pm$ 0.25 inches 1.9 to 7.6 cm $\pm$ 0.6 cm
Compression rate	50 to 150 compressions per minute
<b>ECG Monitoring</b>	
Patient connection	3-lead cable, 5-lead cable, paddles, or hands-free therapy electrodes
Input protection	Fully defibrillator-proof. Special circuitry prevents distortion of ECG during pacer pulse.
Implanted pacemaker spike display	Dedicated circuitry detects most implanted pacemaker spikes and provides standard display marker of spike on ECG trace.

Implanted Pulses Detected	<p><math>\pm 2</math> mV to <math>\pm 700</math>mV amplitude, 0.1ms to 2ms width, with a recharge constant of 0 to 100ms.</p> <p><b>Note:</b> The pacemaker pulse rejection capability for the R Series with pacemaker pulses alone includes pulses between <math>\pm 2</math>mV and <math>\pm 700</math>mV amplitude, with widths between 0.1ms and 2ms and overshoot from 0 to 100ms.</p> <p>The pacemaker pulse rejection capability for the R Series with pacemaker pulses and a normally paced QRS and T wave includes pulses between <math>\pm 2</math>mV and <math>\pm 700</math>mV amplitude, with widths between 0.1ms and 2ms and overshoot from 0 to 100ms.</p> <p>The pacemaker pulse rejection capability for the R Series with pacemaker pulses with an ineffectively paced QRS pattern includes pulses between <math>\pm 2</math>mV and <math>\pm 700</math>mV amplitude, with widths between 0.1ms and 2ms and overshoot from 0 to 100ms.</p> <p>The R Series is not capable of rejecting A-V Sequential pacemaker pulses.</p>
Bandwidth	<p>0.5 Hz to 21 Hz standard; 0.05 Hz to 150 Hz diagnostic</p> <p>0.5 Hz to 40 Hz, and 1 Hz to 21 Hz as configurable options</p>
Lead selection	I, II, III, aVR, aVL, aVF, V, PADS, PADDLES, INTL PADDLES P1, P2, P3 with OneStep Pacing electrodes
ECG size relative scale factor	x0.5, x1, x1.5, x2 or x3 Current value shown on display.
Heart rate range	30 to 300 beats per minute
Heart rate accuracy	$\pm 5\%$
Heart rate alarm	<p>Screen icon indicates activated/deactivated status. User selectable.</p> <p>Tachycardia: 60 to 280 beats per minute Bradycardia: 20 to 100 beats per minute</p>
Tall T-wave Rejection	$\leq 0.8$ mV
Heart Rate Averaging	<p>The R Series averages the interval between the last 6 detected beats. On startup, the R Series averages the rate between detected beats once two beats are detected, until a full 6 beats have been received. The rate is updated every beat. After this condition is met, the meter is updated every beat with an average of the last 6 beats.</p> <p>If a period of time greater than 5 seconds elapses without a beat detected, the heart rate meter reports a rate of 0 bpm, which is repeated every 5 seconds.</p>
Accuracy and Response Time to Irregular Rhythm	<p>Averaging over 5 R -R intervals, per AAMI EC 13:2002:</p> <ul style="list-style-type: none"> <li>• Ventricular bigeminy (Figure 3a) - 80.5 bpm</li> <li>• Slow alternating ventricular bigeminy (Figure 3b) - 60.5 bpm</li> <li>• Slow alternating ventricular bigeminy (Figure 3c) - 120.5 bpm</li> <li>• Bidirectional systoles (Figure 3d) - 93.3 bpm</li> </ul>
Response Time to Change in Heart Rate	<ul style="list-style-type: none"> <li>• 3 seconds maximum for a step increase from 80 bpm to 120 bpm</li> <li>• 6 seconds maximum for a step decrease from 80 bpm to 40 bpm</li> </ul>

Time to Alarm for Tachycardia	from NSR 80 to VT 195 at 1 mV: 4 seconds from NSR 80 to VT 195 at 2 mV: 4 seconds from NSR 80 to VT 195 at 4 mV: 4 seconds from NSR 80 to VT 206 at 0.5 mV: 4 seconds from NSR 80 to VT 206 at 1 mV: 4 seconds from NSR 80 to VT 206 at 2 mV: 4 seconds
Leads Off Sensing	A dc current of 0.04 uA per lead wire is supplied to the patient.
Active Noise Suppression	The sum of all leadwire currents is returned via the active noise suppression leadwire: <ul style="list-style-type: none"> <li>• 0.08 uA DC in 3 lead mode</li> <li>• 0.16 uA DC in 5 lead mode</li> </ul>
<b>Pacemaker option</b>	
Type	VVI demand; asynchronous (fixed rate) when used without ECG leads or in asynchronous (Async) pacing mode
Pulse type	Rectilinear, constant current
Pulse duration	40 ms $\pm$ 2 ms
Pulse amplitude (output)	Variable 0 mA to 140 mA $\pm$ 5% or 5 mA, whichever is greater Increments/decrements by a value of 2 mA
Pacing rate	30 to 180 pulses per minute (ppm) $\pm$ 1.5% Increments/decrements by a value of 2 ppm
Output protection	Fully defibrillator-protected and isolated
<b>Recorder and Stripchart Printer</b>	
Paper	80 mm thermal (grid width) 90 mm (paper width)
Speed	25 mm/s
Delay	6 seconds
Annotations	Time, date, defibrillation energy, heart rate, pacer output, QRS synchronization marker, ECG size, ECG lead, alarm, defibrillator test result, analyze ECG, diagnostic bandwidth  Messages: <i>ANALYSIS HALTED, NOISY ECG, SHOCK ADVISED, NO SHOCK ADV.</i>
Printing method	High-resolution, thermal array print head
Printout modes	Manual or automatic; user-configurable
<b>Data card</b>	
Type	Compact flash card
<b>Sync in / Marker out / ECG out</b>	

Sync In	0-5 V (TTL Level) pulse, active high, 5 to 15 msec in duration, no closer than 200 ms apart. Energy transfer begins within 25 ms of the leading edge of the external sync pulse.	<p style="text-align: center;"><b>R Series Connector Pinout</b></p>  <p>SWITCHCRAFT CONXALL 17982-7SG-300 Mating Connector: SWITCHCRAFT CONXALL 16982-7PG-522</p>
Marker Out	0-5 V (TTL Level) pulse, active high, 10 ms in duration, the leading edge of the pulse occurs within 35 ms of the peak of the R-wave)	
ECG Out	1.0 V/cm of deflection on stripchart recorder <25 ms delay from patient ECG input	
<b>Wi-Fi Card</b>		
ZOLL R Series Data COMM	Model: 802.11 abgn Wireless LAN Compact Flash Card	

### Battery Pack Specifications

Type	Rechargeable lithium ion
Weight	1.7 lb (0.77 kg)
Nominal voltage	10.6 V
Recharge time	4 hours or less within R Series.
Operating time	For a new, fully charged battery at 20°C: <ul style="list-style-type: none"> <li>• 100 defibrillator discharges at maximum energy (200 joules), or</li> <li>• 4 hours of continuous ECG monitoring, or</li> <li>• 3.5 hours of continuous ECG monitoring and pacing at 60 mA, 80 pulses per minute</li> </ul>
Low battery indicator	The message <i>LOW BATTERY</i> is displayed on the screen when there is approximately 15 minutes of ECG monitoring time left on the battery. Two-beep low battery tone sounds once a minute until just before shutdown when the unit beeps twice every 2 seconds.  The time from display of the message <i>LOW BATTERY</i> or <i>REPLACE BATTERY</i> until the defibrillator shuts down varies depending on the battery age and condition.
Battery Shelf Life	3 months before retest and recharge

## IEC 60601-1-2 Specifications

This section provides specification tables for the R Series as per IEC 60601-1-2.

### Electromagnetic Emissions Declaration

Guidance and manufacturer’s declaration — electromagnetic emissions for the R Series.

Emissions test	Compliance	Electromagnetic environment – guidance
RF Emissions CISPR 11	Group 1	The R Series uses RF energy for its internal function only. Therefore, its RF emissions are very low and are not likely to cause any interference in nearby electronic equipment.
RF Emissions CISPR 11	Class B	The R Series is suitable for use in all establishments, including domestic establishments and those directly connected to the public low-voltage power supply network that supplies buildings used for domestic purposes.
Harmonic Emissions IEC 61000-3-2	Class A	
Voltage Fluctuations/ Flicker Emissions IEC 61000-3-3	Complies	
Medical electrical equipment requires special precautions regarding electromagnetic compatibility and must be installed and put into service in accordance with the EMC information provided in this document.		



## Electromagnetic Immunity Declaration (EID)

Guidance and manufacturer's declaration — electromagnetic immunity.


The ZOLL R Series device is intended for use in the electromagnetic environment specified below. Operation outside of this environment could result in the misinterpretation of the ECG rhythms or CPR signals, interference to the display or audio messages, or the inability to provide defibrillation therapy. The operator of the unit must ensure that it is used in this environment.

The ZOLL R Series defibrillator's essential performance energy delivery (defibrillation, pacing, ECG rhythm analysis, ECG, CPR feedback, SpO<sub>2</sub>, EtCO<sub>2</sub> and NIBP) is clinically acceptable and the R Series defibrillator meets basic safety when operated in the electromagnetic environment specified in the following table.

The R Series is intended for use in the electromagnetic environment specified below. Operation outside of this environment could result in the misinterpretation of the ECG rhythms or CPR signals, interference to the display or audio messages, or the inability to provide defibrillation therapy.			
Immunity test	IEC 60601 test level	Compliance level	Electromagnetic environment – guidance
Electrostatic discharge (ESD) IEC 61000-4-2	±6 kV contact ±8 kV air	±6kV contact ±8 kV air	The relative humidity should be at least 30%.
Electrical fast transient/burst IEC 61000-4-4	±2 kV for power supply lines ±1 kV for input/output lines	±2 kV for power supply lines Not applicable	Mains power quality should be that of a typical commercial or hospital environment.
Surge IEC 61000-4-5	±1 kV differential mode ±2 kV common mode	±1 kV differential mode ±2 kV common mode	Mains power quality should be that of a typical commercial or hospital environment.
Voltage dips, short interruptions and voltage variations on power supply input lines IEC 61000-4-11	<5% $U_T$ (>95% dip in $U_T$ ) for 0.5 cycle 40% $U_T$ (60% dip in $U_T$ ) for 5 cycles 70% $U_T$ (30% dip in $U_T$ ) for 25 cycles <5% $U_T$ (>95% dip in $U_T$ ) for 5 seconds	<5% $U_T$ (>95% dip in $U_T$ ) for 0.5 cycle 40% $U_T$ (60% dip in $U_T$ ) for 5 cycles 70% $U_T$ (30% dip in $U_T$ ) for 25 cycles <5% $U_T$ (>95% dip in $U_T$ ) for 5 seconds	Mains power quality should be that of a typical commercial or hospital environment. If the user of the R Series requires continued operation during power mains interruptions, it is recommended that the R Series be powered by an uninterruptible power supply or a battery.
Power frequency (50/60 Hz) magnetic field IEC 61000-4-8	30 A/m	30 A/m	Power frequency magnetic fields should be at levels characteristic of typical location in a typical commercial or hospital environment.
<p>NOTE 1: <math>U_T</math> is the AC mains voltage prior to the application of the test level.</p> <p>NOTE 2: ESD discharges may cause screen flickers, brief screen black outs and in rare occasions a device reset.</p> <p>NOTE 3: The use of accessories and cables other than those specified in the accessories section of this document may result in increased emissions or decreased immunity of the R Series defibrillator.</p> <p>NOTE 4: Certain areas in the hospital environment may control the relative humidity below 30%. In such areas the risk of ESD discharges may be higher than the levels in the R Series tested specifications. Operators should be aware of these conditions and take appropriate action.</p>			

## Electromagnetic Immunity

Guidance and manufacturer’s declaration – electromagnetic immunity.

<p>The functions of the R Series are intended for use in the electromagnetic environment specified below. Operation outside of this environment could result in the misinterpretation of the ECG rhythms or CPR signals, interference to the display or audio messages, or the inability to provide defibrillation therapy.</p>			
Immunity test	IEC 60601 test level	Compliance level	Electromagnetic environment – guidance
<p>Conducted RF IEC 61000-4-6</p> <p>Radiated RF IEC 61000-4-3 (ECG monitoring from Leads &amp; PADS)</p> <p>Radiated RF IEC 61000-4-3 (EtCO<sub>2</sub>, SpO<sub>2</sub>, NIBP, and all other functions)</p>	<p>3 Vrms 150 kHz to 80 MHz outside ISM bands<sup>a</sup></p> <p>10 Vrms 150 kHz to 80 MHz in ISM band<sup>a</sup></p>	<p>3 Vrms</p> <p>10 Vrms<sup>d</sup></p>	<p>Portable and mobile RF communications equipment should be used no closer to any part of the R Series, including cables, than the recommended separation distance calculated from the equation applicable to the frequency of the transmitter.</p> <p><b>Recommended separation distance</b></p> <p><math>d = 1.2 \sqrt{P}</math></p> <p><math>d = 1.2 \sqrt{P}</math></p> <p><math>d = 1.2 \sqrt{P}</math> 80 MHz to 800 MHz <math>d = 2.3 \sqrt{P}</math> 800 MHz to 2.7 GHz</p> <p>where P is the maximum output power rating of the transmitter in watts according to the transmitter manufacturer and d is the recommended separation distance in meters.<sup>b</sup> Field strengths from fixed RF transmitters, as determined by electromagnetic site survey,<sup>c</sup> should be less than the compliance level in each frequency range.<sup>d</sup> Interference may occur in the vicinity of equipment marked with the following symbol:</p> <div style="text-align: center;">  </div>
	<p>10 V/m 80 MHz to 2.7 GHz</p>	<p>10 V/m<sup>d</sup></p>	
	<p>3 V/m 80 MHz to 2.7 GHz</p>	<p>3 V/m<sup>d</sup></p>	
<p>NOTE 1: At 80 MHz and 800 MHz, the higher frequency range applies.</p> <p>NOTE 2: These guidelines may not apply in all situations. Electromagnetic propagation is affected by absorption and reflection from structures, objects, and people.</p>			

a. The ISM (industrial, scientific, and medical) bands between 150 kHz and 80 MHz are 6.765 MHz to 6.795 MHz; 13.553 MHz to 13.567 MHz; 26.957 MHz to 27.283 MHz; and 40.66 MHz to 40.70 MHz.

b. The compliance levels in the ISM frequency bands between 150 kHz and 80 MHz and in the frequency range 80 MHz to 2.7 GHz are intended to decrease the likelihood that mobile/portable communications equipment could cause interference if it is inadvertently brought into patient areas. For this reason, an additional factor of 10/3 is used in calculating the recommended separation distance for transmitters in these frequency ranges.

- c. Field strengths from fixed transmitters, such as base stations for radio (cellular/cordless) telephones and land mobile radios, amateur radio, AM and FM radio broadcast and TV broadcast cannot be predicted theoretically with accuracy. To assess the electromagnetic environment due to fixed RF transmitters, an electromagnetic site survey should be considered. If the measured field strength in the location in which the R Series is used exceeds the applicable RF compliance level above, the R Series should be observed to verify normal operation. If abnormal performance is observed, additional measures may be necessary, such as reorienting or relocating the R Series.
- d. Over the frequency ranges 150 kHz to 80 MHz field strength should be less than 10 V/m, as shown within the compliance column to the left.

## Recommended Separation Distances from RF Equipment for the R Series Functions

Recommended separation distances between portable and mobile RF communications equipment and the R Series.

The functions of the R Series are intended for use in the electromagnetic environment in which radiated RF disturbances are controlled. The customer or user of the R Series can help prevent electromagnetic interference by maintaining a minimum distance between portable and mobile RF communications equipment (transmitters) and the R Series as recommended below, according to the maximum output power of the communications equipment.				
Rated maximum output power of equipment (in watts)	Separation distance according to frequency of transmitter (in meters)			
	150 kHz to 80 MHz outside ISM bands	150 kHz to 80 MHz in ISM bands	80 MHz to 800 MHz	800 MHz to 2.7 GHz
	$d = 1.2 \sqrt{P}$	$d = 1.2 \sqrt{P}$	$d = 1.2 \sqrt{P}$	$d = 2.3 \sqrt{P}$
0.01	0.12	0.12	0.12	0.23
0.1	0.38	0.38	0.38	0.73
1	1.2	1.2	1.2	2.3
10	3.8	3.8	3.8	7.3
100	12	12	12	23
For transmitters rated at a maximum output power not listed above, the recommended separation distance $d$ in meters can be determined using the equation applicable to the frequency of the transmitter, where $P$ is the maximum output power rating of the transmitter in watts according to the transmitter manufacturer.				
NOTE 1: At 80 MHz and 800 MHz, the separation distance for the higher frequency range applies.				
NOTE 2: The ISM (industrial, scientific, and medical) bands between 150 kHz and 80 MHz are 6.765 MHz to 6.795 MHz; 13.553 MHz to 13.567 MHz; 26.957 MHz to 27.283 MHz; and 40.66 MHz to 40.70 MHz.				
NOTE 3: An additional factor of 10/3 is used in calculating the recommended separation distances for transmitters in the ISM frequency bands between 150 kHz and 80 MHz and in the frequency range 80 MHz to 2.7 GHz to decrease the likelihood that mobile/portable communications equipment could cause interference if it is inadvertently brought into patient areas.				
NOTE 4: These guidelines may not apply in all situations. Electromagnetic propagation is affected by absorption and reflection from structures, objects, and people.				

## R Series Rectilinear Biphasic Waveform Characteristics

Table A-1 shows the characteristics of the R Series Rectilinear Biphasic<sup>®</sup> waveform when discharged into 25 ohm, 50 ohm, 100 ohm, 125 ohm, 150 ohm and 175 ohm loads at the maximum energy setting of 200 joules.

**Table A-1. R Series Rectilinear Biphasic Waveform Characteristics**

	200 J discharged into					
	25Ω	50Ω	100Ω	125Ω	150Ω	175Ω
<b>First phase</b>						
Maximum initial current	31.4 A	30.4 A	19.7 A	19.4 A	16.7 A	15.6 A
Average current	27.1 A	24.9 A	17.5 A	16.2 A	14.4 A	13.2 A
Duration	6 ms	6 ms	6 ms	6 ms	6 ms	6 ms
<b>Interphase duration</b> (between first and second phases)						
	200 μs	200 μs	200 μs	200 μs	200 μs	200 μs
<b>Second phase</b>						
Initial current	29.2 A	18.8 A	15.1 A	13.2 A	12.1 A	11 A
Average current	14.7 A	13 A	12.5 A	11.3 A	10.7 A	9.9 A
Duration	4 ms	4 ms	4 ms	4 ms	4 ms	4 ms

**Table A-2. Delivered Energy at Every Defibrillator Setting into a Range of Loads**

Selected Energy	Load							Accuracy
	25Ω	50Ω	75Ω	100Ω	125Ω	150Ω	175Ω	
1 J	1 J	1 J	1 J	1 J	1 J	1 J	1 J	±3 J
2 J	1 J	2 J	2 J	2 J	2 J	2 J	2 J	±3 J
3 J	2 J	3 J	3 J	3 J	3 J	3 J	3 J	±3 J
4 J	3 J	4 J	4 J	5 J	5 J	5 J	4 J	±3 J
5 J	3 J	5 J	6 J	6 J	6 J	6 J	6 J	±3 J
6 J	4 J	6 J	7 J	7 J	7 J	7 J	7 J	±3 J
7 J	5 J	7 J	8 J	8 J	8 J	8 J	8 J	±3 J
8 J	5 J	8 J	9 J	9 J	10 J	9 J	9 J	±3 J
9 J	6 J	9 J	10 J	11 J	11 J	11 J	10 J	±3 J
10 J	7 J	10 J	12 J	12 J	12 J	12 J	12 J	±3 J
15 J	10 J	16 J	17 J	18 J	18 J	18 J	17 J	±3 J
20 J	14 J	21 J	23 J	24 J	24 J	24 J	23 J	±15%
30 J	21 J	32 J	35 J	36 J	37 J	36 J	35 J	±15%
50 J	35 J	54 J	59 J	61 J	62 J	61 J	59 J	±15%
70 J	49 J	76 J	83 J	85 J	87 J	86 J	83 J	±15%
75 J	53 J	81 J	89 J	91 J	93 J	92 J	89 J	±15%
85 J	60 J	92 J	101 J	104 J	106 J	104 J	101 J	±15%
100 J	71 J	109 J	119 J	122 J	125 J	123 J	119 J	±15%
120 J	85 J	131 J	143 J	147 J	150 J	147 J	143 J	±15%

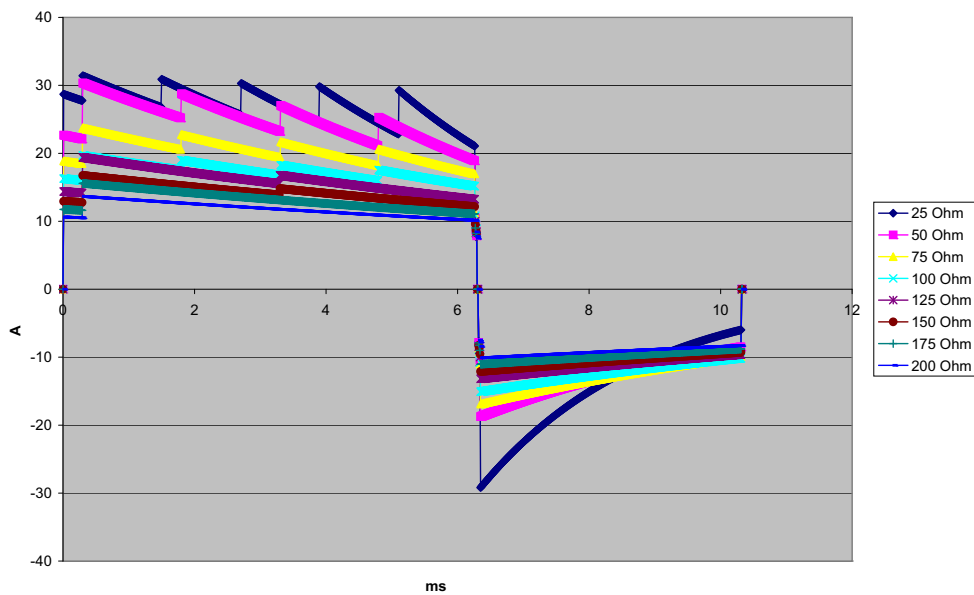
**Table A-2. Delivered Energy at Every Defibrillator Setting into a Range of Loads**

Selected Energy	Load							Accuracy
	25Ω	50Ω	75Ω	100Ω	125Ω	150Ω	175Ω	
150 J	107 J	164 J	180 J	183 J	188 J	184 J	179 J	±15%
200 J	142 J	230 J	249 J	253 J	269 J	261 J	260 J	±15%

The R Series Rectilinear Biphasic waveform employs the same first and second phase timing, similar first and second phase currents/voltages, and essentially the same mechanisms for controlling defibrillation waveshape as the ZOLL M Series<sup>®</sup> defibrillator. The M Series and R Series defibrillation waveforms are considered substantially equivalent.

Figures A-1 through A-21 show the Rectilinear Biphasic waveforms that are produced when the R Series defibrillator is discharged into loads of 25, 50, 75, 100, 125, 150, and 175 ohms at each energy setting.

The vertical axis shows the current in amperes (A); the horizontal axis shows the duration of time in milliseconds (ms).



**Figure A-1. Rectilinear Biphasic Waveform at 200 Joules**

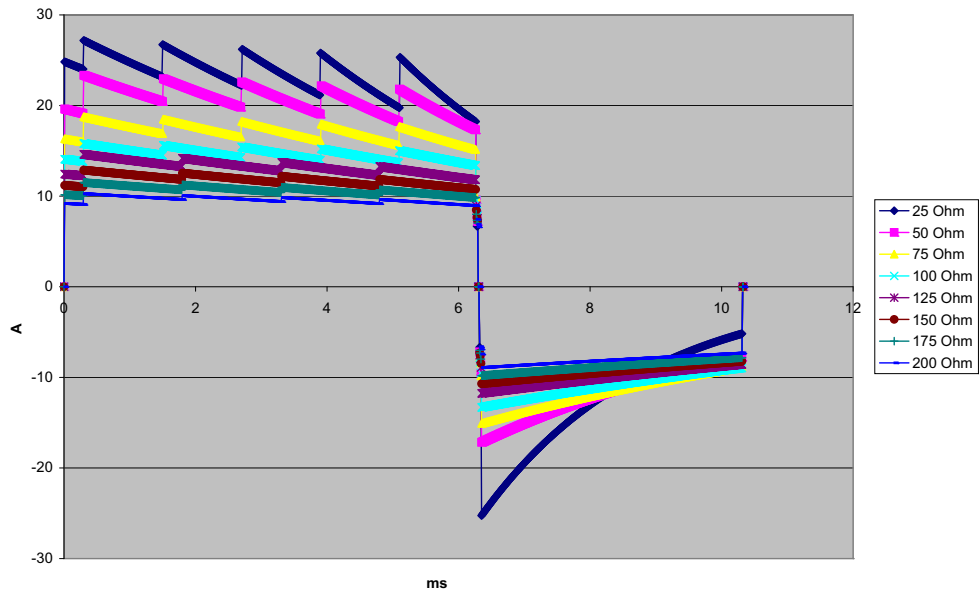


Figure A-2. Rectilinear Biphasic Waveform at 150 Joules

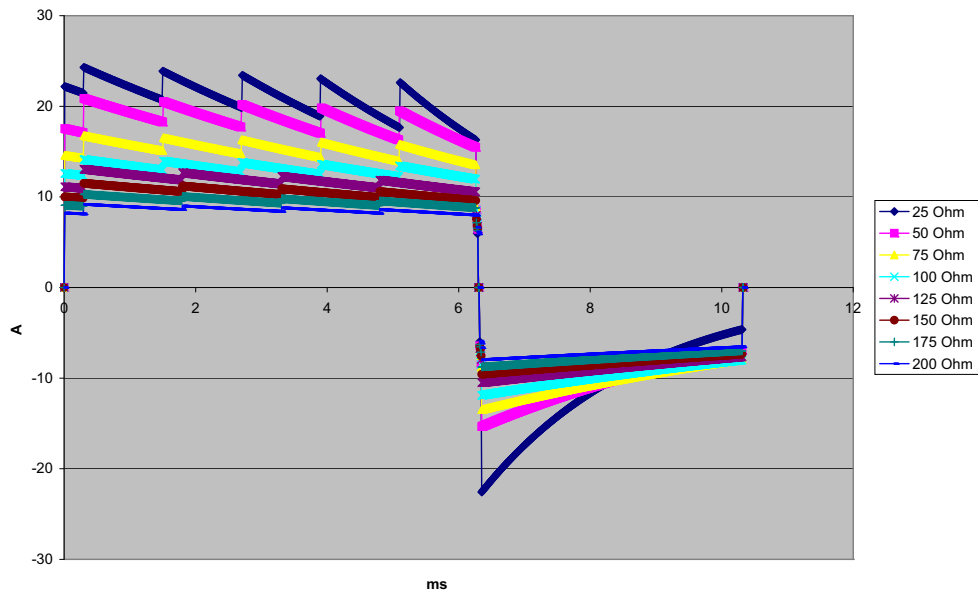


Figure A-3. Rectilinear Biphasic Waveform at 120 Joules

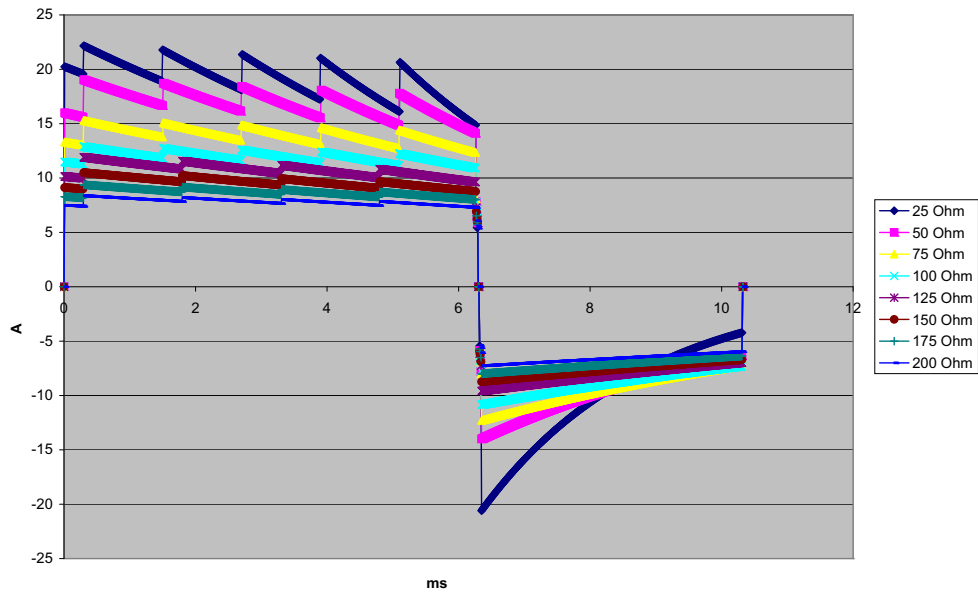


Figure A-4. Rectilinear Biphasic Waveform at 100 Joules

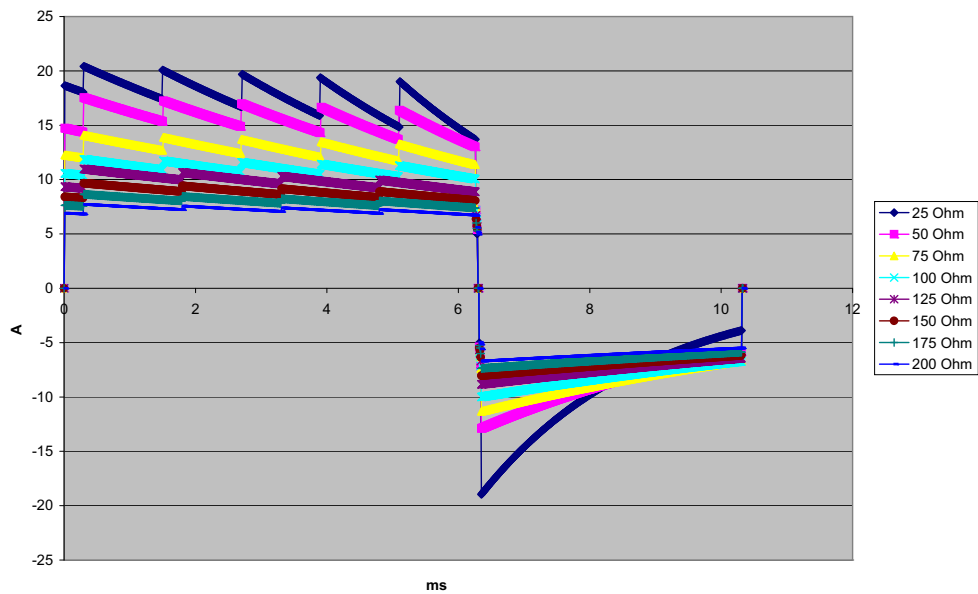


Figure A-5. Rectilinear Biphasic Waveform at 85 Joules

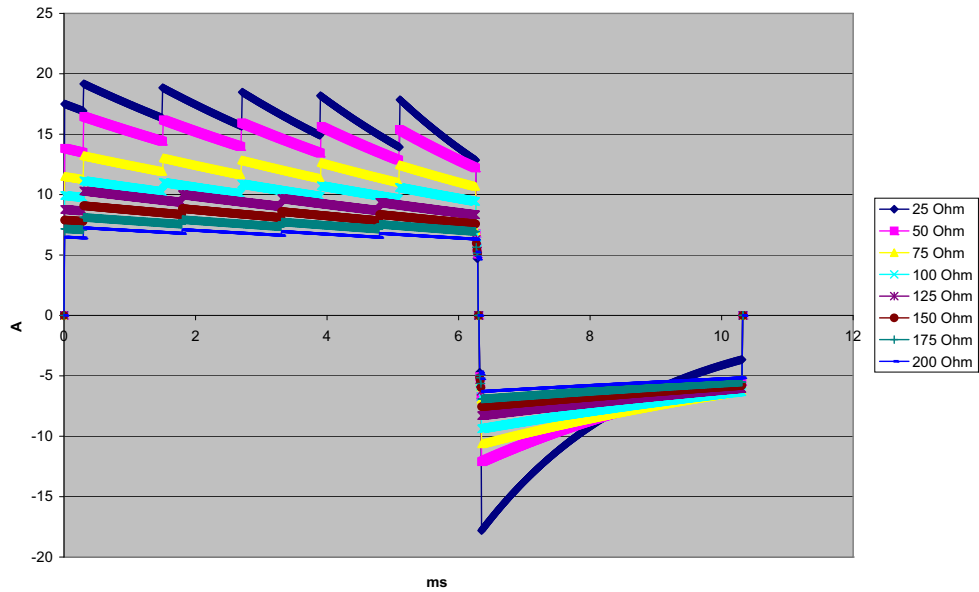


Figure A-6. Rectilinear Biphasic Waveform at 75 Joules

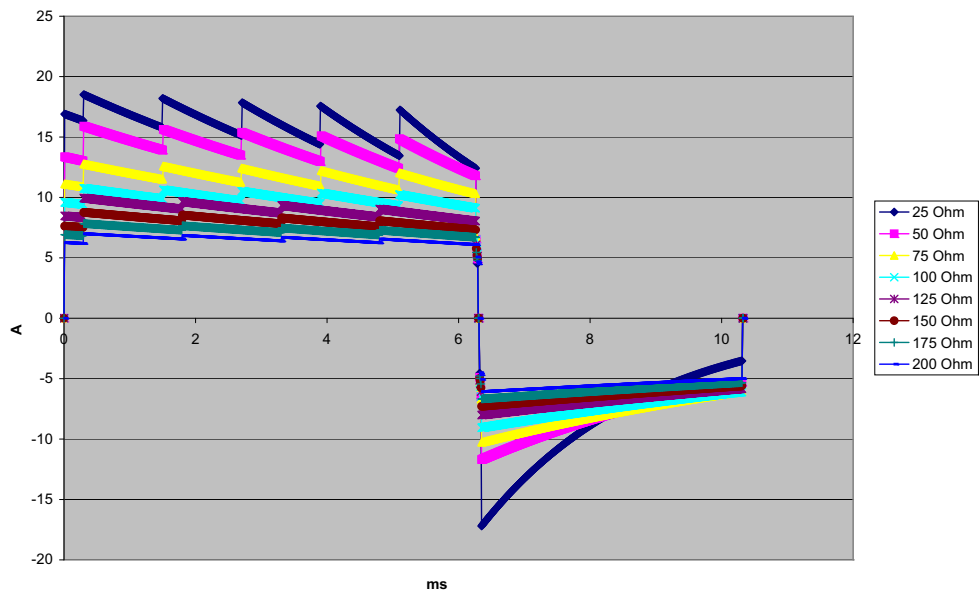


Figure A-7. Rectilinear Biphasic Waveform at 70 Joules



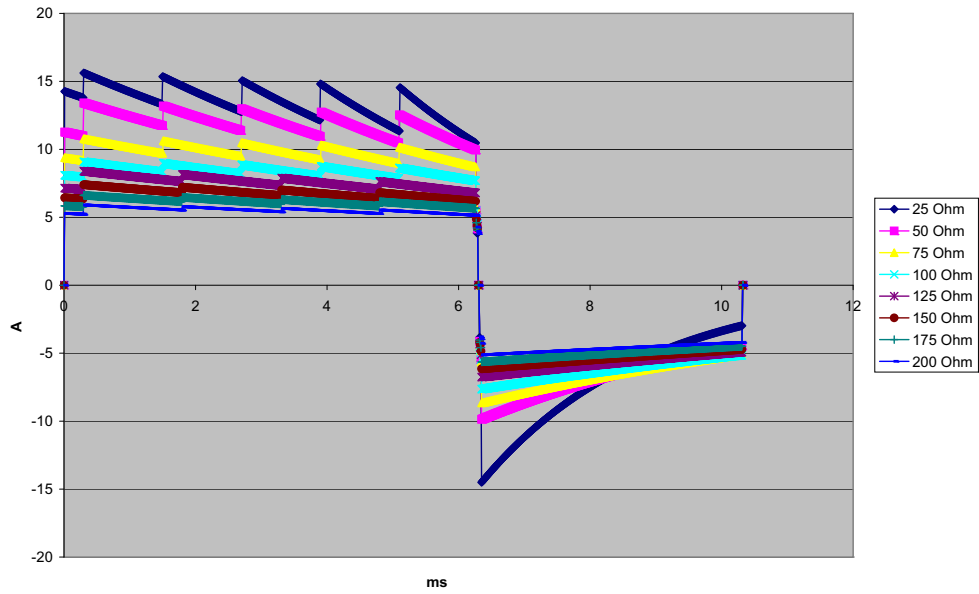


Figure A-8. Rectilinear Biphasic Waveform at 50 Joules

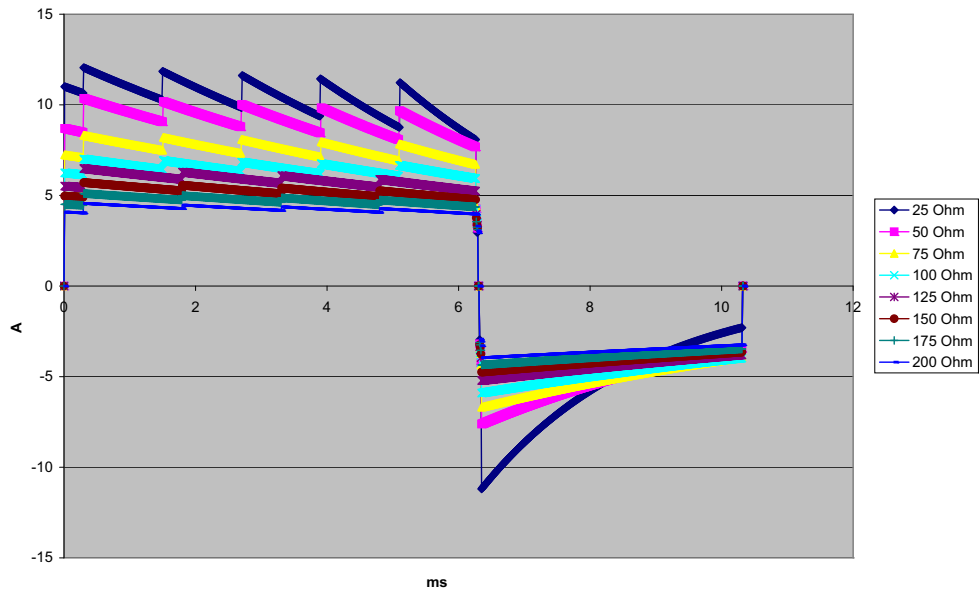


Figure A-9. Rectilinear Biphasic Waveform at 30 Joules

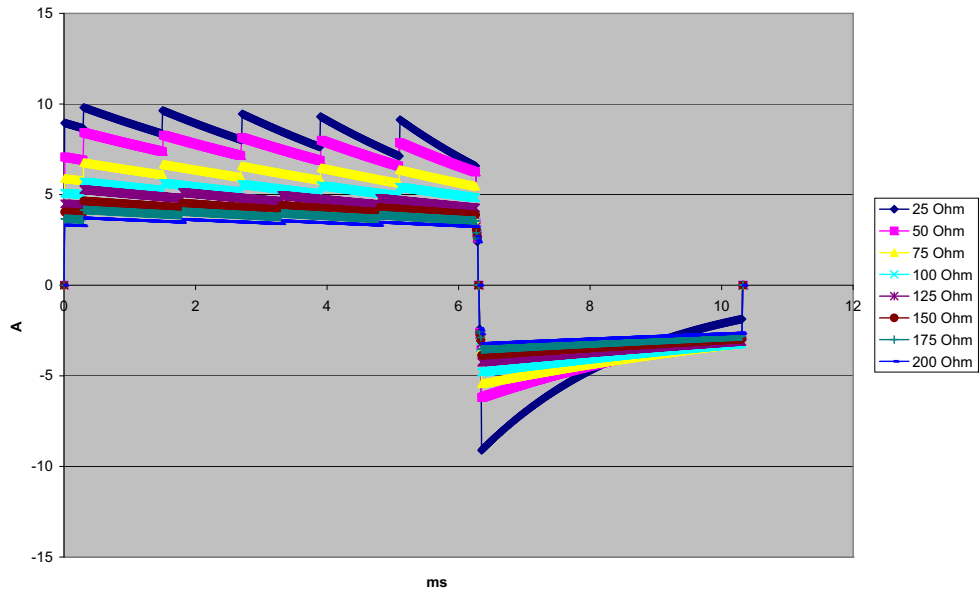


Figure A-10. Rectilinear Biphasic Waveform at 20 Joules

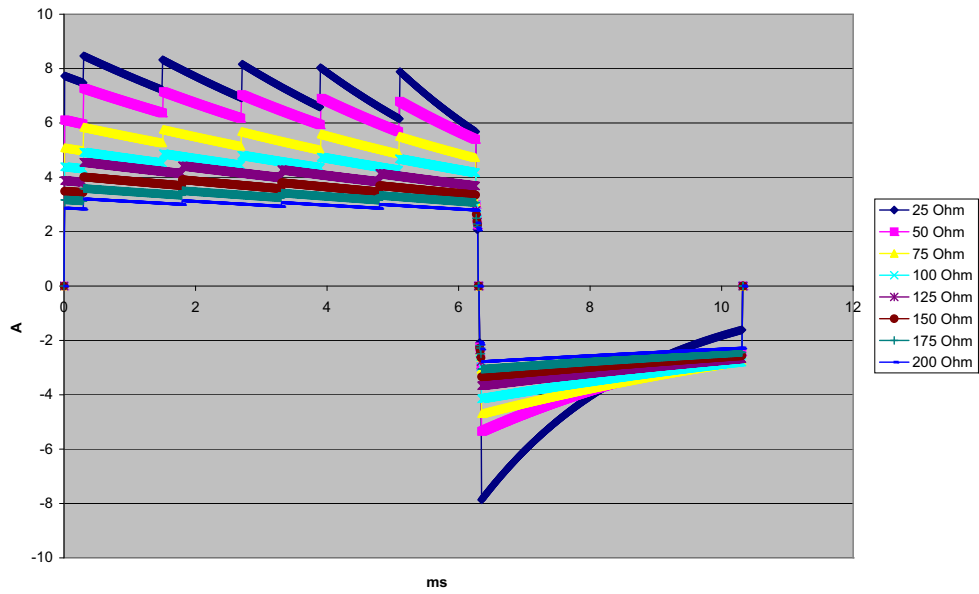


Figure A-11. Rectilinear Biphasic Waveform at 15 Joules

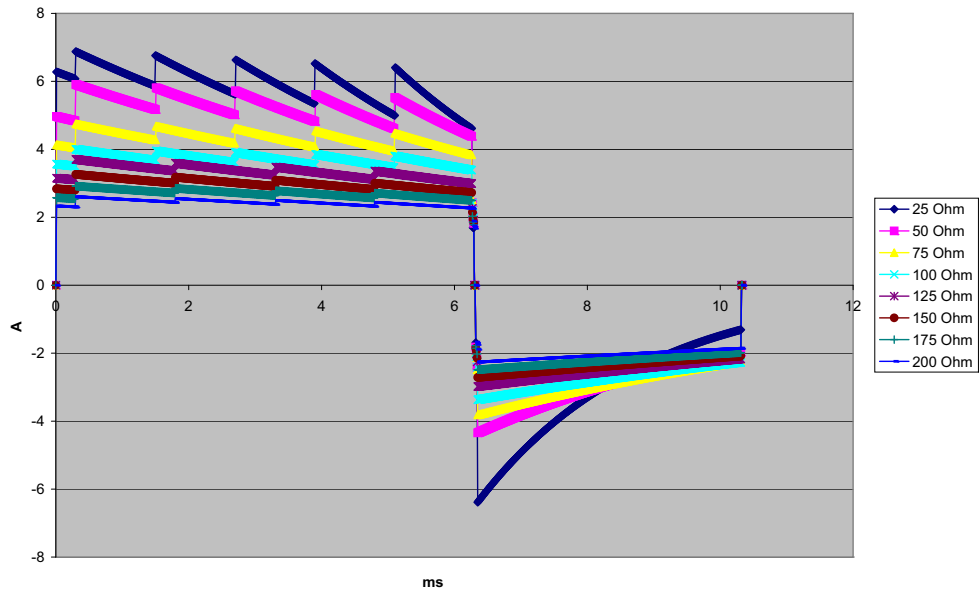


Figure A-12. Rectilinear Biphasic Waveform at 10 Joules

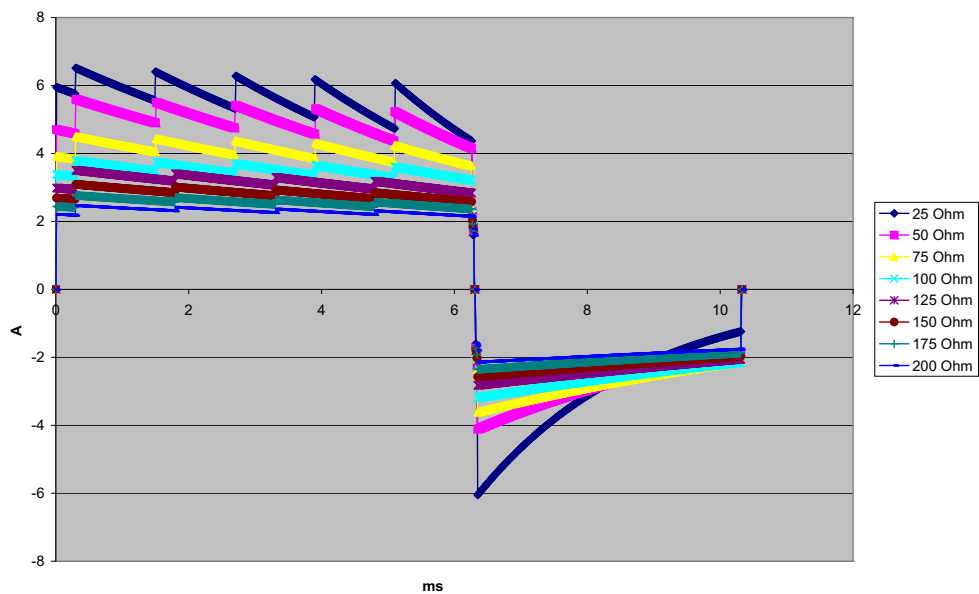


Figure A-13. Rectilinear Biphasic Waveform at 9 Joules

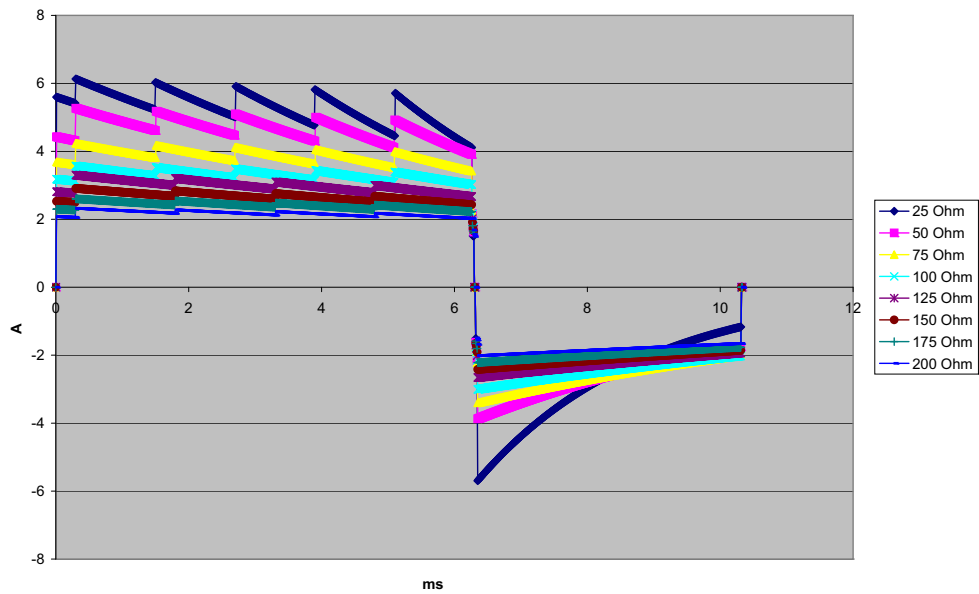


Figure A-14. Rectilinear Biphasic Waveform at 8 Joules

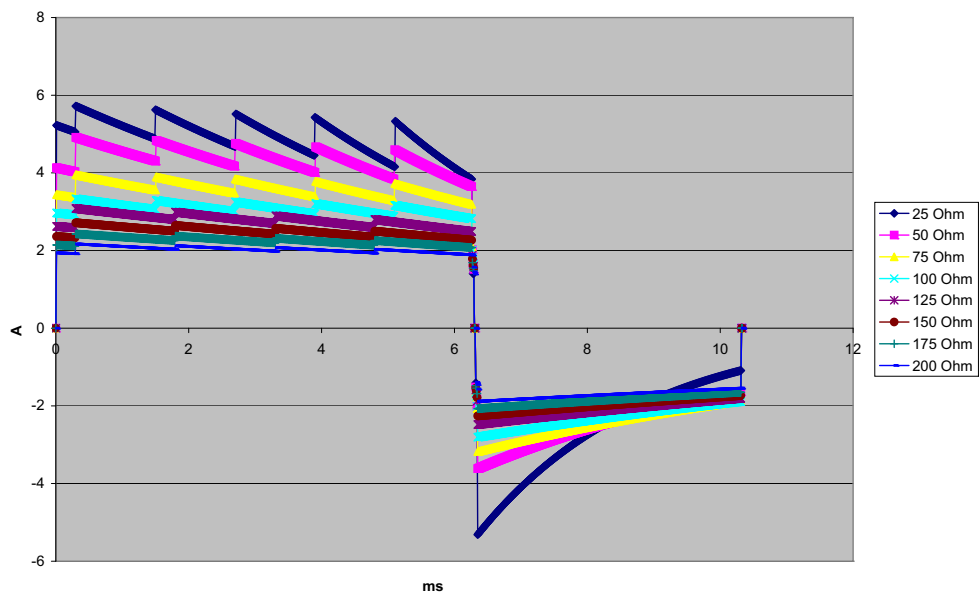


Figure A-15. Rectilinear Biphasic Waveform at 7 Joules

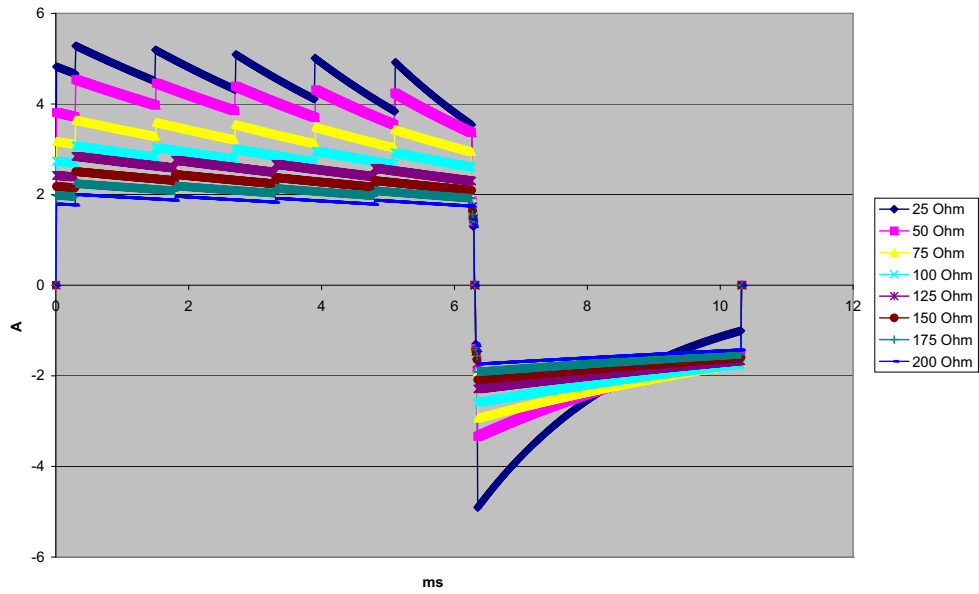


Figure A-16. Rectilinear Biphasic Waveform at 6 Joules

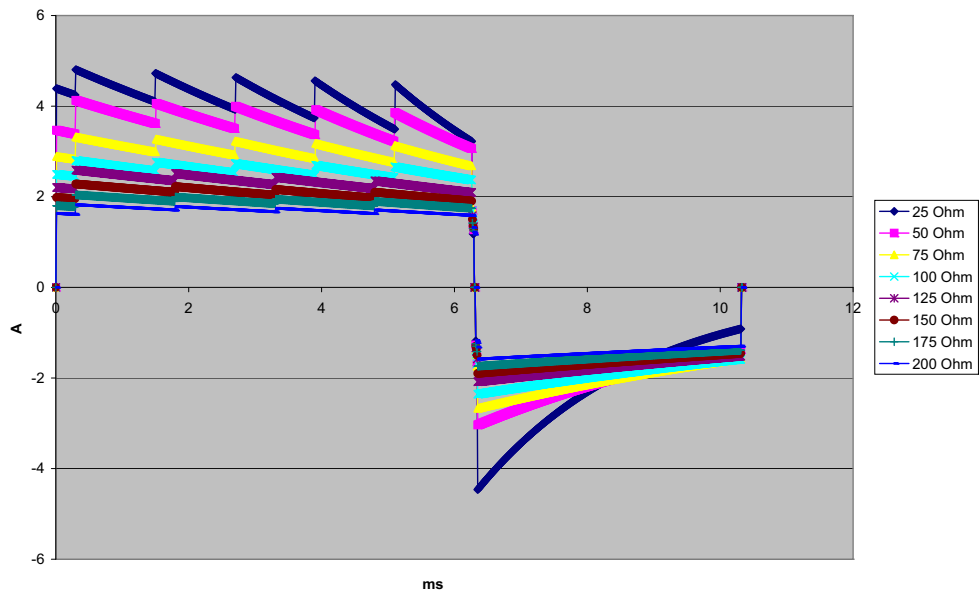


Figure A-17. Rectilinear Biphasic Waveform at 5 Joules

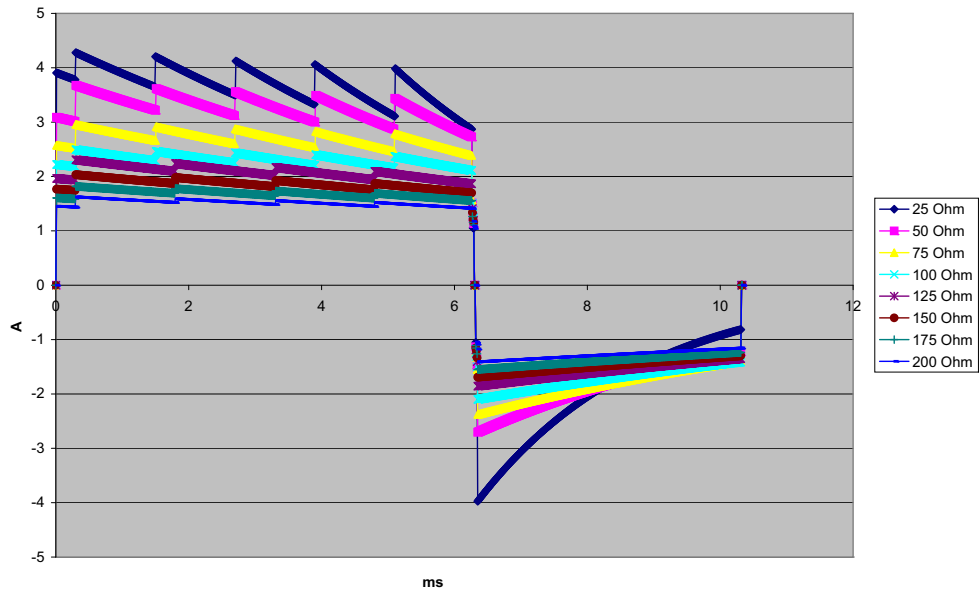


Figure A-18. Rectilinear Biphasic Waveform at 4 Joules

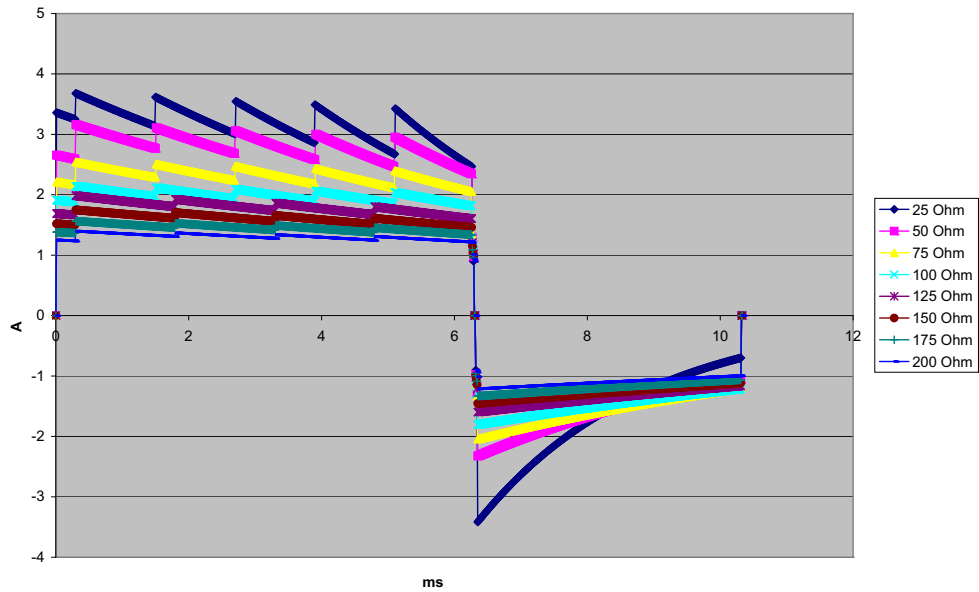


Figure A-19. Rectilinear Biphasic Waveform at 3 Joules

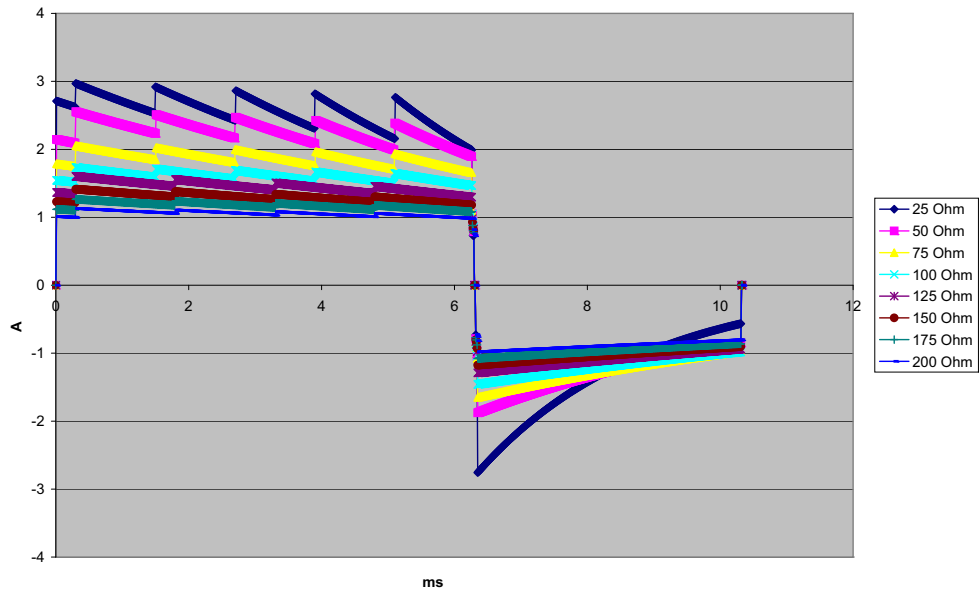


Figure A-20. Rectilinear Biphasic Waveform at 2 Joules

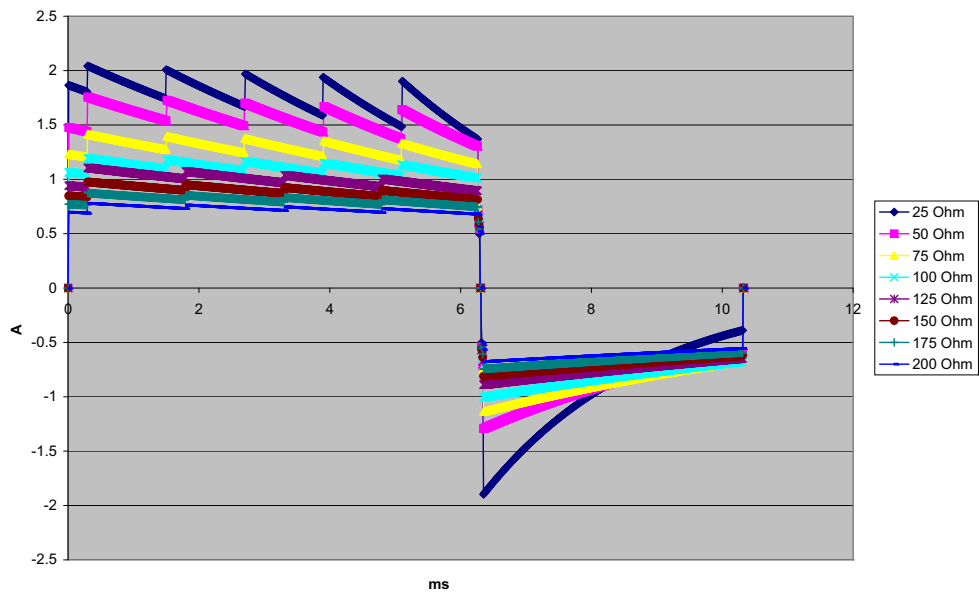


Figure A-21. Rectilinear Biphasic Waveform at 1 Joule

## Clinical Trial Results for the Biphasic Waveform

The efficacy of the ZOLL Rectilinear Biphasic waveform has been clinically verified during a study of defibrillation of Ventricular Fibrillation (VF) and Ventricular Tachycardia (VT). A feasibility study was performed initially for defibrillation of VF/VT (n=20) on two separate groups of patients to ensure waveform safety and energy selection. Subsequently, a separate, multicenter, randomized clinical trial was performed to verify the waveform's efficacy. A description of this study is provided below. The study was performed using ZOLL defibrillation systems consisting of ZOLL defibrillators, the ZOLL Rectilinear Biphasic waveform, and ZOLL defibrillation electrodes.

### Randomized Multicenter Clinical Trial for Defibrillation of Ventricular Fibrillation (VF) and Ventricular Tachycardia (VT)

**Overview:** The defibrillation efficacy of the ZOLL Rectilinear Biphasic waveform was compared to a monophasic damped sine waveform in a prospective, randomized, multicenter study of patients undergoing ventricular defibrillation for VF/VT during electrophysiological studies, ICD implants, and test. A total of 194 patients were enrolled in the study. Ten patients who did not satisfy all protocol criteria were excluded from the analysis, leaving a study population of 184.

**Objectives:** The primary goal of this study was to compare the first shock efficacy of the 120 J rectilinear biphasic waveform with a 200 J monophasic waveform. The secondary goal was to compare all shock (three consecutive 120, 150, and 170 joules) efficacy of the rectilinear biphasic waveform with that of a monophasic waveform (three consecutive 200, 300, and 360 joules). A significance level of  $p=0.05$  or less was considered statistically significant using Fischer's Exact test. Also, differences between the two waveforms were considered statistically significant when the customary 95% or AHA-recommended 90%<sup>1</sup> confidence interval between the two waveforms was greater than 0%.

**Results:** The study population of 184 patients had a mean age of  $63\pm 14$  years. Of these, 143 patients were male. There were no adverse events or injuries related to the study.

The first shock, first induction efficacy of biphasic shocks at 120 J was 99% versus 93% for monophasic shocks at 200 J ( $p=0.0517$ , 95% confidence interval of the difference of  $-2.7\%$  to  $16.5\%$  and 90% confidence interval of the difference of  $-1.01\%$  to  $15.3\%$ ).

Successful defibrillation with rectilinear biphasic shocks was achieved with 58% less delivered current than with monophasic shocks ( $14\pm 1$  amperes versus  $33\pm 7$  amperes,  $p=0.0001$ ).

The difference in efficacy between the rectilinear biphasic and the monophasic shocks was greater in patients with high transthoracic impedance (greater than 90 ohms). The first shock, first induction efficacy of biphasic shocks was 100% versus 63% for monophasic shocks for

---

1. Kerber RE, et al., "Automated External Defibrillators for Public Access Defibrillation: Recommendations for Specifying and Reporting Arrhythmia Analysis Algorithm Performance, Incorporating New Waveforms, and Enhancing Safety," *Circ J Am Heart Assoc.* 1997;95:1677-1682.

"... the task force suggests that to demonstrate superiority of an alternative waveform over standard waveforms, the upper boundary of the 90% confidence interval of the difference between standard and alternative waveforms must be  $<0\%$  (ie, alternative is greater than standard)."



patients with high impedance ( $p=0.02$ , 95% confidence interval of the difference of  $-0.0217\%$  to  $0.759\%$  and 90% confidence interval of the difference of  $0.037\%$  to  $0.706\%$ ).

A single patient required a second biphasic shock at 150 joules to achieve 100% efficacy versus six patients for whom monophasic shocks of up to 360 joules were required for 100% total defibrillation efficacy.

**Conclusion:** The data demonstrate the equivalent efficacy of low energy rectilinear biphasic shocks compared to standard high energy monophasic shocks for transthoracic defibrillation for all patients at the 95% confidence level. The data also demonstrate the superior efficacy of low energy rectilinear biphasic shocks compared to standard high energy monophasic shocks in patients with high transthoracic impedance at the 90% confidence level. There were no unsafe outcomes or adverse events due to the use of rectilinear biphasic waveform.

## Pre-Clinical Study

To support pediatric usage for the ZOLL Rectilinear Bi-Phasic Waveform, ZOLL submitted pre-clinical data to the FDA as part of a 510(k) submission for its R Series device (cleared by the FDA under K060559). The protocol for this pre-clinical study, along with a summary of the results, have been submitted to FDA under R Series PMA application (P160022). A summary of this study is presented below.

To demonstrate the safety and efficacy of our Rectilinear Bi-Phasic Waveform when used to treat pediatric VF patients, ZOLL conducted a study using a porcine model of pediatric patients less than 8 years of age. This study included 18 piglets in three (3) size groups (two (2) animals weighing 4 kg, eight (8) animals weighing 8 kg, and eight (8) animals weighing 16 kg) and compared the defibrillation dose/response curves observed using proposed biphasic waveform with those observed using a standard monophasic damped sine wave (DSW) defibrillator to treat short duration (~ 30 seconds) ventricular fibrillation. The study demonstrated that the biphasic waveform defibrillates pediatric pigs with equal efficacy but lower energy (on a Joules/kg basis) than traditional monophasic damped sine wave defibrillators. To confirm the safety of the proposed biphasic waveform in pediatric patients, we studied and compared measures of cardiac function before and after both DSW and Rectilinear Bi-Phasic Waveform defibrillation shocks over a range of relevant energies. The study demonstrated that the biphasic defibrillation produced equivalent or milder disturbances of cardiac function when compared to traditional DSW defibrillation at the same energies.

Another animal study compared the ZOLL rectilinear biphasic (RLB) waveform to a biphasic truncated exponential (BTE) waveform. The study, using an immature porcine model ( $n=21$ ), was a prospective, randomized, controlled design to determine the dose response curves for the RLB and BTE defibrillation waveforms. A weight range from 4 to 24 Kg for an animal represented a pediatric patient. The weight ranging from 4 to 8 Kg represented a patient less than 1 year old (infant subgroup), and the weight range from 16 to 24 Kg represented a pediatric patient between the ages of 2 and 8 years (young children subgroup).

The ZOLL RLB waveform demonstrated a superior capability to defibrillate a porcine pediatric model with  $< 90\%$  of the D50 energy required for a BTE waveform (D50 energy: RLB  $25.6 \pm 15.7$  J, BTE  $28.6 \pm 17.0$  J,  $P = 0.0232$ ; D90 energy: RLB  $32.6 \pm 19.1$  J, BTE  $37.8 \pm 23.2$  J,  $P = 0.0228$ ).

The ECG ST segment changes (mV) and LV pressure changes (dP/dt) following a defibrillation shock were compared between the RLB waveform to the BTE waveform. The RLB waveform had an average ST segment increase above baseline of  $0.138 \pm 0.136$  mV ( $N=401$  shocks) compared to the BTE waveform's average increase of  $0.146 \pm 0.148$  mV ( $N=396$  shocks). The

RLB waveform had an average dP/dt at the 40 mmHg threshold (the point in time when an animal's blood pressure exceeded 40 mmHg spontaneously) of  $1987 \pm 411$  mmHg/s (N=496 shocks) compared to the BTE waveform's average dP/dt of  $2034 \pm 425$  mmHg/s (N=496 shocks).

## Published Clinical Data

Additional clinical data was included with PMA application P160022 to support out-of-hospital use of ZOLL's Rectilinear Bi-Phasic defibrillation waveform. The data reported by Hess et al in Resuscitation (82 (2011) 685–689) is considered sufficient to support ZOLL's defibrillation waveform in the out-of-hospital environment. The resulting clinical paper, "Performance of a rectilinear biphasic waveform in defibrillation of presenting and recurrent ventricular fibrillation: A prospective multicenter study," was included with PMA application P160015. A summary of the study is presented below:

**Objectives:** The study tested the hypothesis that shock success differs with initial and recurrent episodes of ventricular fibrillation (VF).

**Methods:** From September 2008 to March 2010 out-of-hospital cardiac arrest patients with VF as the initial rhythm at 9 study sites were defibrillated by paramedics using a rectilinear biphasic waveform. Shock success was defined as termination of VF within 5 s post-shock. The study used generalized estimating equation (GEE) analysis to assess the association between shock type (initial versus defibrillation) and shock success.

**Results:** Ninety-four patients presented in VF. Mean age was 65.4 years, 78.7% were male, and 80.9% were bystander-witnessed. VF recurred in 75 (79.8%). There were 338 shocks delivered for initial (n = 90) or recurrent (n = 248) VF available for analysis. Initial shocks terminated VF in 79/90 (87.8%) and subsequent shocks in 209/248 (84.3%). GEE odds ratio (OR) for shock type was 1.37 (95% CI 0.68–2.74). After adjusting for potential confounders, the OR for shock type remained insignificant (1.33, 95% CI 0.60–2.53). The study observed no significant difference in ROSC (54.7% versus 52.6%, absolute difference 2.1%, p = 0.87) or neurologically intact survival to hospital discharge (21.9% versus 33.3%, absolute difference 11.4%, p = 0.31) between those with and without VF recurrence.

**Conclusions:** Presenting VF was terminated with one shock in 87.8% of cases. The study observed no significant difference in the frequency of shock success between initial versus recurrent VF. VF recurred in the majority of patients and did not adversely affect shock success, ROSC, or survival.

## Randomized Multi-Center Clinical trial for Cardioversion of Atrial Fibrillation (AF)

**Overview:** The defibrillation efficacy of ZOLL's Rectilinear Biphasic Waveform was compared to a monophasic damped sine waveform in a prospective randomized multi-center study of patients undergoing cardioversion of their atrial fibrillation. A total of 173 patients entered the study. Seven (7) patients who did not satisfy all protocol criteria were excluded from the analysis. ZOLL disposable gel electrodes with surface areas of 78 cm<sup>2</sup> (anterior) and 113 cm<sup>2</sup> (posterior) were used exclusively for the study.

**Objective:** The primary goal of the study was to compare the total efficacy of four consecutive rectilinear biphasic shocks (70J, 120J, 150J, 170J) with four consecutive monophasic shocks (100J, 200J, 300J, 360J). The significance of the multiple shocks efficacy was tested

statistically via two procedures, the Mantel-Haenszel statistic and the log-rank test, significance level of  $p=0.05$  or less was considered statistically significant. The data are completely analogous to the comparison of two "survival" curves using a life-table approach where shock number plays the role of time.

The secondary goal was to compare the first shock success of rectilinear biphasic and monophasic waveforms. A significance level of  $p=0.05$  or less was considered statistically significant using Fisher Exact tests. Also, differences between the two waveforms were considered statistically significant when the 95% confidence interval between the two waveforms was greater than 0%.

**Results:** The study population of 165 patients had a mean age of  $66\pm 12$  years with 116 male patients.

The total efficacy of consecutive rectilinear biphasic shocks was significantly greater than that of monophasic shocks. The following table displays the Kaplan-Meier (product-limit) "survival" curves for each of the two waveforms. As all patients begin in the failure mode, the estimated life-table probabilities refer to the chance of still being in failure after the  $k^{\text{th}}$  shock ( $k=1,2,3,4$ ):

**Table A-3. Kaplan-Meier Estimate for the Probability of Shock Failure**

Shock #	Biphasic	Monophasic
0	1.000	1.000
1	0.318	0.792
2	0.147	0.558
3	0.091	0.324
4	0.057	0.208

As can be seen from the table, the Biphasic experience is superior over the entire course of shocks delivered. The one degree of freedom chi-square statistic for the Mantel-Haenszel test is 30.39 ( $p<0.0001$ ). Similarly, the log-rank test, also a one degree of freedom chi-square statistic, is 30.38 ( $p<0.0001$ ). The residual number of patients not successfully treated after four shocks is 5.7% for biphasic compared to 20.8% for monophasic.

There was a significant difference between the first shock efficacy of biphasic shocks at 70J of 68% and that of monophasic shocks at 100J of 21% ( $p=0.0001$ , 95% confidence interval of the difference of 34.1% to 60.7%).

Successful cardioversion with rectilinear biphasic shocks was achieved with 48% less delivered current than with monophasic shocks ( $11\pm 1$  vs.  $21\pm 4$  A,  $p<0.0001$ ).

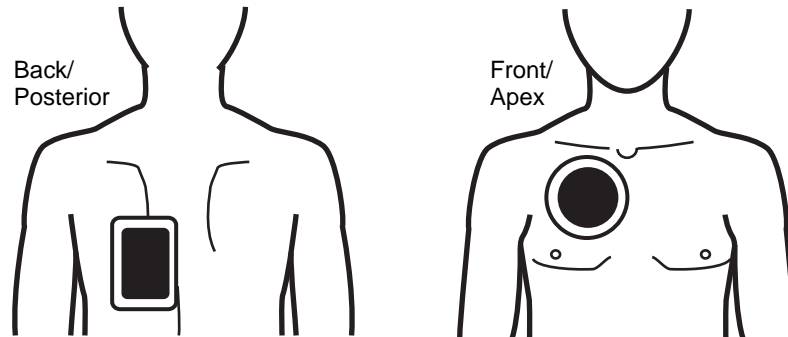
One half of the patients who failed cardioversion after four consecutive escalating monophasic shocks were subsequently successfully cardioverted using a biphasic shock at 170J. No patient was successfully cardioverted using a 360J monophasic shock after the patient had failed cardioversion with biphasic shocks.

**Conclusion:** The data demonstrate the superior efficacy of low energy rectilinear biphasic shocks compared to high energy monophasic shocks for transthoracic cardioversion of atrial fibrillation. There were no unsafe outcomes or adverse events due to the use of Rectilinear Biphasic Waveform.

## Synchronized Cardioversion of Atrial Fibrillation

Cardioversion of atrial fibrillation (AF) and overall clinical effectiveness is enhanced by proper pad placement. Clinical studies (refer to above) of the M Series Biphasic Defibrillator Waveform demonstrated that high conversion rates are achieved when defibrillation pads are placed as shown in the diagram below.

Recommended Anterior/Posterior Placement



Place the front (apex) pad on the third intercostal space, mid clavicular line on the right anterior chest. The back/posterior pad should be placed in the standard posterior position on the patient's left as shown.

## ECG Rhythm Analysis Algorithm Accuracy

Sensitivity and specificity are expressions of ECG rhythm analysis algorithm performance when compared to ECG interpretation by a clinician or expert. Sensitivity refers to the algorithm's ability to correctly identify shockable rhythms (as a percentage of the total number of shockable rhythms). Specificity refers to the algorithm's ability to correctly identify nonshockable rhythms (as a percentage of the total number of nonshockable rhythms).

The data in Table A-4 and Table A-5 summarize the accuracy of the ECG rhythm analysis algorithm as tested against ZOLL's ECG rhythm database. Rhythm sources included data records from ZOLL devices and public domain databases recorded with electrode systems and ECG signal processing characteristics similar to the R Series. Data records were of appropriate length to allow for satisfactory analysis.

The algorithm sequence takes approximately 9 seconds and proceeds as follows:

- Divides the ECG rhythm into 3-second segments
- Filters and measures noise, artifact, and baseline wander
- Measures baseline content ("waviness" at the correct frequencies – frequency domain analysis) of signal
- Measures QRS rate, width, and variability
- Measures amplitude and temporal regularity (autocorrelation) of peaks and troughs
- Determines if multiple 3-second segments are shockable and then prompts the operator to treat the patient

**Table A-4. Clinical Performance Results (Adult Patients)**

Rhythms	Sample Size	Performance Goals	Observed Performance	90% One-sided Lower Confidence Limit
<b>Shockable</b>		<b>Sensitivity</b>		
Coarse VF	536	>90%	100.0%	99.4%
Rapid VT	80	>75%	98.8%	99.2%
<b>Nonshockable</b>		<b>Specificity</b>		
NSR	2210	>99%	99.6%	99.8%
AF, SB, SVT, heart block, idioventricular, PVCs	819	>95%	100.0%	99.6%
Asystole	115	>95%	100.0%	97.4%
<b>Intermediate</b>				
Fine VF	69	Report only	94.2%	87.2%
Other VT	28	Report only	100.0%	89.9%

**Table A-5. Clinical Performance Results (Pediatric Patients)**

Rhythms	Sample Size (9 second records)	Performance Goals	Observed Performance	90% One-sided Lower Confidence Limit
<b>Shockable (49 patients)</b>		<b>Sensitivity</b>		
Coarse VF	49	>90%	100.0%	93.1%
Rapid VT	79	>75%	100.0%	96.3%
<b>Nonshockable (155 patients)</b>		<b>Specificity</b>		
NSR	208	>99%	100.0%	98.6%
AF, SB, SVT <sup>a</sup> , heart block, idioventricular, PVCs	348	>95%	99.4%	98.2%
Asystole	29	>95%	100.0%	90.2%
<b>Intermediate (16 patients)</b>				
Fine VF	0	Report only	—	—
Other VT	44	Report only	81.8%	89.6%

a. 161 of the 348 abnormal rhythm records were SVT (72 patients). The SVT heart rates ranged from 152 to 302 beats per minute.

Arrhythmia performance is reported according to the article, Kerber RE, Becker LB, Bourland JD, Cummins RO, Hallstrom AP, Michos MB, Nichol G, Ornato JP, Thies WH, White RD, Zuckerman BD. “Automated External Defibrillators for Public Access Defibrillation: Recommendations for Specifying and Reporting Arrhythmia Analysis Algorithm Performance, Incorporating New Waveforms, and Enhancing Safety,” *Circ J Am Heart Assoc.* 1997;95:1677-1682.

## References

Young KD, Lewis RJ. “What is confidence? Part 2: Detailed definition and determination of confidence intervals”. *Ann Emerg Med.* September 1997;30:311-318.

Beyer WH. Percentage Points, F-Distribution Table. *CRC Standard Mathematical Tables.* 28<sup>th</sup> ed. Boca Raton, Fla: CRC Press; 1981:573.

# Appendix B

## R Series Accessories

The following accessories are compatible for use with R Series products. To order any of these items, contact your local ZOLL representative.

SPU = Single Patient Use

<b>Electrodes/Pads, Paddles, and Connectors</b>
OneStep resuscitation electrodes
OneStep Basic Pacing/defibrillation electrodes with Monitor while Pace (MWP)
OneStep resuscitation electrodes with CPR (anterior/posterior)
OneStep resuscitation electrodes with CPR (anterior/anterior)
OneStep Complete
OneStep pediatric resuscitation electrodes (1 or 8 pair/box)
OneStep pediatric resuscitation electrodes with CPR (1 or 8 pair/box)
Adult, Multi-Function Pacing/Defibrillation Stat-padz (12 pair/box)
Pediatric, Multi-Function Pacing/Defibrillation Pedi-padz
External Paddle Assembly Apex/Sternum with built in pediatric electrodes
External autoclavable handles
Internal autoclavable handles, no switch
Internal autoclavable handles, with switch
Molded autoclavable internal handles, no switch
Molded autoclavable internal handles, with switch
<b>Cables</b>
OneStep Cable (100-240V, 50/60Hz)
OneStep Pacing Cable (100-240V, 50Hz)

AAMI 3-Lead Wire ECG Patient Cable (6' or 12')
AAMI 3-Lead Wire ECG Patient Cable, ESU
IEC 3-Lead ECG Patient Cable
AAMI 5-Lead Wire ECG Patient Cable
IEC 5-Lead Wire ECG Patient Cable
Power Cord Extension Cable (12")
AC power cord
<b>Batteries and Chargers</b>
SurePower Charger
SurePower Battery
<b>SpO2 Sensors and Cables</b>
LNCS Amtx Single use sensor for patients > 30 kg
LNCS Pmtx Single use sensor for Pediatrics and Slender Adults 10-50 kg
LNCS Inf-L Single use sensor for Infants 3-20 kg
LNCS Neo-L Single use sensor for Neonates < 3 kg
LNCS NeoPt-L Single use sensor for Neonates < 1 kg (Pre-term)
LNCS DCI Reusable sensor for Adults and Pediatrics > 30 kg
LNCS DCIP Reusable sensor for Pediatrics 10-50 kg
LNC-4 4' Reusable Patient Cable
LNC-10 10' Reusable Patient Cable
LNC Ext LNC Extension Cable, DB-9 Termination, 4ft
LNCS-to-LNOP Adapter Cable, LNCS Sensor to LNOP Patient Cable
LNOP DC-12 LNOP Adult Reusable Direct Connect 12' Cable
<b>EtCO2 Sensors and Cables</b>
<b>Mainstream</b>
CAPNOSTAT 5 CO <sub>2</sub> Sensor and Cable
SPU Pediatric/Adult Airway Adapter
SPU Neonatal/Pediatric Airway Adapter
Reusable Adult Airway Adapter
Reusable Neonatal/Pediatric Airway Adapter
SPU Pediatric/Adult Airway Adapter with Mouthpiece



CAPNO <sub>2</sub> mask, Large Adult
CAPNO <sub>2</sub> mask, Standard Adult
CAPNO <sub>2</sub> mask, Pediatric
<b>Sidestream</b>
LoFlo Module and Cable
SPU Nasal CO <sub>2</sub> Sampling Cannula, Adult
SPU Nasal CO <sub>2</sub> Sampling Cannula, Pediatric
SPU Nasal CO <sub>2</sub> Sampling Cannula, Infant/neonate
SPU Oral/Nasal CO <sub>2</sub> Sampling Cannula, Adult
SPU Oral/ Nasal CO <sub>2</sub> Sampling Cannula, Pediatric
SPU Nasal CO <sub>2</sub> Sampling with O <sub>2</sub> Delivery Cannula, Adult
SPU Nasal CO <sub>2</sub> Sampling with O <sub>2</sub> Delivery Cannula, Pediatric
SPU Oral/Nasal CO <sub>2</sub> Sampling with O <sub>2</sub> Delivery Cannula, Adult
SPU Oral/Nasal CO <sub>2</sub> Sampling with O <sub>2</sub> Delivery Cannula, Pediatric
SPU Adult/Pediatric Airway Adapter Kit (ET tube sizes > 4.0 mm)
SPU Adult/Pediatric Airway Adapter Kit with Nafion tubing (ET tube sizes > 4.0 mm)
SPU Pediatric/Infant Airway Adapter Kit (ET tube sizes ≤ 4.0 mm)
SPU Pediatric/Infant Airway Adapter Kit with Nafion tubing (ET tube sizes ≤ 4.0 mm)
<b>NIBP Cuffs and Hoses</b>
Thigh, reusable: 38 to 50 cm (14.96 to 19.69 in.)
Large Adult, reusable: 31 to 40 cm (12.20 to 15.75 in.)
Adult, reusable: 23 to 33 cm (9.06 to 12.99 in.)
Small Adult, reusable: 17 to 25 cm (6.69 to 9.84 in.)
Child, reusable: 12 to 19 cm (4.72 to 7.48 in.)
Neonate #5, disposable: 8.0 cm to 15.0 cm (3.1 to 5.9 in.)
Neonate #4, disposable: 7.0 to 13.0 cm (2.8 to 5.1 in.)
Neonate #3, disposable: 6.0 to 11.0 cm (2.4 to 4.3 in.)
Neonate #2, disposable: 4.0 to 8.0 cm (1.6 to 3.1 in.)
Neonate #1, disposable: 3.0 to 6.0 cm (1.2 to 2.4 in.)
Air hose with pneumatic fittings 3 m (9.8 ft.)
Air hose with pneumatic fittings 1.5 m (4.9 ft.)
<b>Miscellaneous</b>
Recorder Paper, 80mm Fan Fold (10 or 20 pkgs)
R Series Data COMM Card
R Series Data COMM II Card

---

(This page intentionally left blank.)

# Appendix C

## Wi-Fi Radio Module Information

---

If this defibrillator contains an optional low power Wi-Fi radio module, it transmits information between the defibrillator and a wireless network (infrastructure mode). The module complies with the following standards:

- Part 15 of the FCC Rules. Operation is subject to the following two conditions: (1) this device may not cause harmful interference, and (2) this device must accept any interference received including interference that may cause undesired operation (of the radio function).
- RSS 247 of Industry & Science Canada. Operation is subject to the following two conditions: (1) this device may not cause harmful interference, and (2) this device must accept any interference received including interference that may cause undesired operation (of the radio function).

**Note:** “Harmful interference” is defined by the FCC as follows: Any emission, radiation or induction that endangers the functioning of a radio navigation service or of other safety services; or seriously degrades, obstructs or repeatedly interrupts a radiocommunications service operating in accordance with FCC rules.

Changes or modifications to Wi-Fi settings on R Series wireless communication accessories not expressly approved by the administrator responsible for compliance could void the user’s authority to operate the equipment.

The user is cautioned to maintain 8 inches (20 cm) of space from the product to ensure compliance with FCC requirements.

FCC/IC/EU: This device is limited to indoor use in the 5150 MHz to 5250 MHz band.

Radio	Frequency Range (MHz)	Output Power (EIRP) (dBm / Watts)
802.11a/b/g/n	2412 - 2472 5180 - 5320 5500 - 5700	14.8 dBm / 0.03 W 15.4 dBm / 0.035 W 15.3 dBm / 0.034 W

(This page intentionally left blank.)

# ZOLL®

## R Series® ALS Operator's Guide

---



The issue date for the R Series Operator's Guide ALS (REF 9650-0912-01 Rev. U) is **December, 2017**.

Copyright © 2017 ZOLL Medical Corporation. All rights reserved.

R Series, M Series, Pedi-padz, Pro-padz, Stat-padz, CodeNet, Real CPR Help, RescueNet, See-Thru CPR, Code-Ready, SurePower, OneStep, Smart Alarms, Perfusion Performance Indicator, Defib Mentor, Rectilinear Biphasic, and ZOLL are trademarks or registered trademarks of ZOLL Medical Corporation in the United States and/or other countries.

Masimo is a registered trademark of Masimo Corporation in the United States and/or other countries.

All other trademarks are property of their respective owners.

Caution: Federal law restricts this device to sale by or on the order of a licensed practitioner.



**ZOLL Medical Corporation**  
269 Mill Road  
Chelmsford, MA USA  
01824-4105



**ZOLL International Holding B.V.**  
Newtonweg 18  
6662 PV ELST  
The Netherlands



0123

## Indication of Use

### Defibrillator Function

The R Series system is indicated for defibrillation on victims of cardiac arrest where there is apparent lack of circulation as indicated by:

- Unconsciousness.
- Absence of breathing.
- Absence of pulse.

The R Series system in the Manual mode is indicated for synchronized cardioversion of certain atrial or ventricular arrhythmias. A qualified physician must decide when synchronized cardioversion is appropriate.

The R Series system Semiautomatic and Manual mode is indicated for use in early defibrillation programs where the delivery of a defibrillator shock during resuscitation involving CPR, transportation, and definitive care are incorporated into a medically-approved patient care protocol.

The R Series system Semiautomatic and Manual mode is indicated for adult and pediatric patients.

### ECG Monitoring

The R Series system is indicated to evaluate the patient's heart rate or ECG morphology via ECG monitoring. In ECG monitoring mode, the feature is indicated for use by personnel who are qualified by training in the use of the R Series defibrillator, basic life and/or advanced life support, or other physician-authorized emergency medical training.

### Real CPR Help

The R Series system is indicated to provide visual and audio feedback via the CPR Help feature, which is designed to encourage rescuers to perform chest compressions at the AHA/ERC recommended depth and rate of 2 inches (5 cm) and 100 compressions per minute.

### External Pacemaker

The R Series system is indicated for temporary external cardiac pacing in conscious or unconscious patients as an alternative to endocardial stimulation. External Pacing is indicated for pediatric and adult patients.

### SpO<sub>2</sub> Monitoring

The R Series system is indicated for the continuous, noninvasive monitoring of arterial oxygen saturation (SpO<sub>2</sub>) and pulse rate during both no motion and patient motion conditions for adult patients, and no motion conditions for pediatric and neonatal patients in a hospital or prehospital environment.

### EtCO<sub>2</sub> Monitoring

The R Series system is indicated for the continuous noninvasive monitoring of end tidal carbon dioxide (EtCO<sub>2</sub>) and respiration rate in patients requiring ventilator support, in-hospital transport, or anesthesia. EtCO<sub>2</sub> Monitoring is indicated for in patients from newborn (neonate) to adult.

---

## Non-Invasive Blood Pressure Monitoring (NIBP)

The R Series system is indicated for the non-invasive measurement of arterial blood pressure for resting patients in critical care and in-hospital transport. The NIBP feature is indicated to measure blood pressure for patients from newborn (neonate) to adult.

## CONTRAINDICATIONS

### **The R Series Semiautomatic Operation Contraindications for Use**

The rhythm analysis function may not reliably identify ventricular fibrillation in the presence of an implanted pacemaker. Inspection of the electrocardiogram and clinical evidence of cardiopulmonary arrest should be the basis for any treatment of patients with implanted pacemakers. Do not use the rhythm analysis function during patient movement on a stretcher. A patient must be motionless during ECG analysis. Do not touch the patient during analysis. Cease all movement of the stretcher prior to analyzing the ECG.

## General Information

Federal (U.S.A.) law restricts this defibrillator to sale by or on the order of a physician.



# Table of Contents

Indication of Use .....	iii
Defibrillator Function .....	iii
ECG Monitoring .....	iii
Real CPR Help .....	iii
External Pacemaker .....	iii
SpO <sub>2</sub> Monitoring .....	iii
EtCO <sub>2</sub> Monitoring .....	iii
Non-Invasive Blood Pressure Monitoring (NIBP) .....	iv
CONTRAINDICATIONS .....	iv
General Information .....	iv

## Chapter 1 General Information

Product Description .....	1-1
How to Use This Manual.....	1-2
Operator's Guide Updates.....	1-3
Unpacking.....	1-3
Symbols Used on the Equipment .....	1-3
Conventions.....	1-6
Defibrillator Function.....	1-6
Intended Use — Manual Operation .....	1-6
Intended Use — ECG Monitoring .....	1-7
Intended Use — Real CPR Help .....	1-7
Defibrillator Complications .....	1-7
Defibrillator Output Energy .....	1-7
External Pacemaker (Optional).....	1-7
Intended Use — Pacemaker .....	1-8
Pacemaker Complications .....	1-8
Pediatric Pacing .....	1-9
Intended Use — SpO <sub>2</sub> Monitoring .....	1-9
Intended Use — EtCO <sub>2</sub> Monitoring.....	1-10
Intended Use — NIBP.....	1-10
ECG Monitoring .....	1-11
Recorder Function .....	1-11
Paddles and Electrodes.....	1-11
Batteries.....	1-12
Code-Ready System.....	1-13
Safety Considerations.....	1-14

Warnings.....	1-14
Operator Safety .....	1-16
Patient Safety .....	1-17
Cautions.....	1-18
Restarting the Defibrillator .....	1-18
FDA Tracking Requirements.....	1-19
Notification of Adverse Events .....	1-19
Software License .....	1-20
Service.....	1-20
The ZOLL Serial Number.....	1-22

## Chapter 2 Product Overview

Defibrillator Controls and Indicators.....	2-1
The Front Panel .....	2-3
Display Screen .....	2-5
Patient Cables and Connectors .....	2-7
External Paddles .....	2-9
Working with Menus.....	2-11
Defib Mentor Mode (Optional) .....	2-12
Common Tasks .....	2-13
Replacing a Battery Pack .....	2-13
Adjusting Display Brightness .....	2-13
Using Code Markers .....	2-14

## Chapter 3 Manual Defibrillation

Emergency Defibrillation Procedure with Paddles.....	3-1
Determine the Patient’s Condition Following Local Medical Protocols .....	3-1
Begin CPR Following Local Medical Protocols. ....	3-2
1 Select DEFIB .....	3-2
2 Charge Defibrillator .....	3-4
3 Deliver Shock .....	3-5
Autoclavable External Paddles.....	3-5
Emergency Defibrillation Procedure with Hands-Free Therapy Electrodes.....	3-6
Determine the Patient’s Condition Following Local Medical Protocols .....	3-6
Begin CPR Following Medical Protocols .....	3-6
Prepare Patient .....	3-6
1 Select DEFIB .....	3-8
2 Charge Defibrillator .....	3-9
3 Deliver Shock .....	3-10
Autoclavable Electrodes .....	3-10

---

## Chapter 4 Advisory Defibrillation

Advisory Defibrillation Procedure.....	4-2
Determine the Patient's Condition Following Local Medical Protocols .....	4-2
Begin CPR Following Local Medical Protocols .....	4-2
Prepare Patient .....	4-2
1 Select DEFIB .....	4-2
2 Press ANALYZE Button .....	4-3
3 Press SHOCK .....	4-5
Advisory Function Messages.....	4-7
Warning Messages .....	4-7

## Chapter 5 Synchronized Cardioversion

Synchronized Cardioversion Procedure .....	5-2
Determine the Patient's Condition and Provide Care Following Local Medical Protocols .....	5-2
Prepare Patient .....	5-2
1 Select DEFIB .....	5-3
2 Charge Defibrillator .....	5-4
3 Deliver SHOCK .....	5-5
Remote Synchronized Cardioversion Procedure.....	5-5
Determine the Patient's Condition and Provide Care Following Local Medical Protocols .....	5-6
Prepare Patient .....	5-6
1 Select DEFIB .....	5-6
2 Charge Defibrillator .....	5-7
3 Deliver SHOCK .....	5-7

## Chapter 6 Real CPR Help

Real CPR Help Field.....	6-2
Perfusion Performance Indicator (Optional/Adult Only) .....	6-2
CPR Idle Time Display .....	6-2
CPR Rate and Depth Display .....	6-2
Compression Release Bar (Adult only) .....	6-3
CPR Metronome .....	6-3
Fully Release prompt .....	6-3
CPR Voice Prompts (Adult only).....	6-4
Chest Compressions Bar Graph.....	6-4
Displaying the CPR Bar Graph .....	6-4

## Chapter 7 See-Thru CPR (Optional)

Using See-Thru CPR .....	7-2
Examples .....	7-2

## Chapter 8 Noninvasive Temporary Pacing (Optional)

Noninvasive Temporary Pacing .....	8-2
Determine Patient Condition and Provide Care Following Local Medical Protocols ...	8-2
Prepare the Patient .....	8-2
1 Apply ECG Electrodes/Hands-Free Therapy Electrodes .....	8-2
2 Turn Selector Switch to PACER .....	8-3
3 Set Pacer Rate .....	8-3
4 Set Pacer Output .....	8-4
5 Determine Capture .....	8-5
6 Determine Optimum Threshold .....	8-6
Special Pacing Applications .....	8-7
Standby Pacing .....	8-7
Asynchronous Pacing .....	8-7
Pediatric Pacing .....	8-8

## Chapter 9 ECG Monitoring

Preparations .....	9-2
Electrode Placement.....	9-2
Monitoring Electrodes Attachment .....	9-3
Monitoring the Patient's ECG.....	9-5
Set the Controls .....	9-5
Implanted Pacemakers .....	9-5
5-Lead Monitoring.....	9-7
Simultaneous 3-Lead Printing .....	9-7
See-Thru CPR Filter (Optional) .....	9-7
Adding Traces to Be Displayed .....	9-8
Printing the ECG on a Stripchart .....	9-8
Diagnostic Bandwidth .....	9-8
Alarms.....	9-9
Setting Alarm Limits .....	9-9
Heart Rate Alarm Limits .....	9-10
Vital Sign Alarms .....	9-10
Suspending and Silencing Alarms .....	9-10
Smart Alarms .....	9-11
Alarm Settings for Unattended Monitoring .....	9-12

## Chapter 10 Event Records and Reports

Summary Report.....	10-1
Summary Report Formats .....	10-2
Printing the Entire Summary Report .....	10-7
Printing a Partial Summary Report .....	10-8
Full Disclosure Recording.....	10-8
Incident Logs .....	10-8
Printing an Incident Log .....	10-8

---

Erasing Summary Report and Full Disclosure .....	10-9
Manual Erasure .....	10-9
Automatic Erasure .....	10-9
Formatting the Disk .....	10-9
Related Messages .....	10-9

## Chapter 11 File Transfer

Transferring Files to an External Device .....	11-1
Wi-Fi (Optional).....	11-2
Installing or Removing a Compact Flash Card .....	11-2
Transferring a Full Disclosure File to a Compact Flash Card .....	11-3
Transferring Device Check and Activity Log Files to a Compact Flash Card.....	11-3
Transferring Files Through the USB Port (Optional).....	11-4
Transferring Full Disclosure Files Through Wi-Fi (Optional) .....	11-5
Transferring Device Check and Activity Log Files Through Wi-Fi (Optional) .....	11-6
Related Wi-Fi Messages .....	11-7

## Chapter 12 Maintenance

Routine Procedures .....	12-2
Daily Visual Inspection .....	12-2
Code Readiness Test .....	12-3
Manual Defibrillator Testing.....	12-3
Defibrillator Testing with Paddles .....	12-4
Defibrillator Testing with Hands-Free Therapy Electrodes .....	12-5
Pacer Testing .....	12-5
Recorder Check .....	12-6
Code Readiness Log .....	12-6
Setting Time and Date .....	12-8
Cleaning the R Series Unit .....	12-8
Loading Stripchart Paper .....	12-9
Cleaning the Print Head .....	12-10
Operator's Checklist for R Series Product .....	12-11

## Chapter 13 Troubleshooting

Code-Ready .....	13-1
Monitor .....	13-2
Recorder .....	13-3
Pacer .....	13-4
Defibrillator .....	13-5
AC Charger .....	13-7
CPR .....	13-7

## Appendix A Specifications

Defibrillator Specifications .....	A-2
Battery Pack Specifications .....	A-7
IEC 60601-1-2 Specifications .....	A-7
Electromagnetic Emissions Declaration .....	A-7
Electromagnetic Immunity Declaration (EID) .....	A-8
Electromagnetic Immunity .....	A-9
Recommended Separation Distances from RF Equipment for the R Series Functions .....	A-10
R Series Rectilinear Biphasic Waveform Characteristics .....	A-11
Clinical Trial Results for the Biphasic Waveform .....	A-23
Randomized Multicenter Clinical Trial for Defibrillation of Ventricular Fibrillation (VF) and Ventricular Tachycardia (VT) .....	A-23
Pre-Clinical Study .....	A-24
Published Clinical Data .....	A-25
Randomized Multi-Center Clinical trial for Cardioversion of Atrial Fibrillation (AF) ...	A-25
Synchronized Cardioversion of Atrial Fibrillation .....	A-27
ECG Rhythm Analysis Algorithm Accuracy .....	A-28

## Appendix B R Series Accessories

## Appendix C Wi-Fi Radio Module Information

# Chapter 1

## General Information

---

### Product Description

The ZOLL® R Series® products combine a defibrillator, ECG display, advanced monitoring capabilities, and Noninvasive Transcutaneous Pacing (NTP) with communication, data printing and recording capabilities in a single lightweight portable instrument. The unit has been designed for all resuscitation situations and its small, compact, lightweight design makes it ideal for accompanying patients during in-hospital transport. The product is powered by AC mains and an easily replaced battery pack that is quickly recharged in the device when it is connected to AC mains. In addition, the unit's battery may be recharged and tested using a ZOLL SurePower™ Battery Charger.

The product is designed for use only in the hospital. All of its ruggedized features add to its durability in hospital applications.

**There are multiple models of the R Series defibrillator that can contain a variety of functions. Your model may not contain all of the functions that are documented in this manual. Those features that are not contained in all models are specified as optional.**

The R Series is a versatile manual/advisory external defibrillator. When operating in the manual configuration, the device operates as a conventional defibrillator where the device's charging and discharging are fully controlled by the operator. In advisory mode, some of the features of the device are automated and a sophisticated algorithm is used to identify shockable ECG rhythms (VF and wide complex VT >150 bpm) that should be treated by defibrillator shock delivery. Depending on local protocols, the unit may be configured to automatically analyze the ECG, charge the defibrillator (if appropriate), and prompt the operator to *PRESS SHOCK* between periods of CPR.

The R Series unit assists caregivers during cardiopulmonary resuscitation (CPR) by evaluating the rate and depth of chest compressions and providing feedback to the rescuer.

Real CPR Help<sup>®</sup> requires the use of OneStep<sup>™</sup> CPR electrodes or OneStep Complete electrodes. When using these pads, the displayed ECG waveforms can be adaptively filtered, using the See-Thru CPR<sup>®</sup> feature, to reduce the artifact caused by chest compressions.

The R Series is a Code-Ready<sup>®</sup> defibrillator. It extends testing beyond shock delivery and checks more than 40 measures of readiness, including the presence of the correct cables and electrodes, the type of electrode, and other important electronic functions. The R Series also verifies the condition and expiration date of OneStep electrodes. This code readiness testing can occur automatically, without disconnecting electrodes or paddles, or requiring additional equipment to test shock delivery. The system also provides a printed, or electronic log to alert hospital personnel of any defibrillator functions or accessories that are compromised in advance of a code.

Some R Series models include an optional transcutaneous pacemaker consisting of a pulse generator and ECG sensing circuitry. The pacing option supports both demand and asynchronous noninvasive pacing for adult, pediatric, or neonatal patients. OneStep Pacing electrodes and OneStep Complete electrodes allow demand pacing and ECG monitoring without separate ECG electrodes when the R Series is used with the OneStep Pacing cable.

Information regarding the unit's operation, ECG, and other physiological waveforms are displayed on a large 6.5 inch (16.5 cm) diagonal display which provides high contrast and visibility under virtually all lighting conditions. Operating and warning messages are displayed on the monitor, and the unit can also be configured with voice prompts to alert the user to unit status. The R Series performs code readiness testing when the unit is OFF but connected to AC power, when the defibrillator is initially turned on, and periodically during operation.

An annotating strip chart recorder is included to provide immediate documentation as well as summary report functions about patient care and treatment.

A sophisticated data collection system, including summary report, printer, and multiple communication ports is available for this unit. The stored data can be reviewed and archived on a properly equipped personal computer using ZOLL CodeNet<sup>®</sup> Central software or ZOLL RescueNet<sup>®</sup> Code Review software. R Series data files may be transferred to a PC using USB or Compact Flash cards or Wi-Fi.

R Series products are intended for use in Manual mode by personnel certified by appropriate federal, state, or local government authority to provide advanced life support care.

## How to Use This Manual

The R Series Operator's Guide provides information operators need for the safe and effective use and care of the R Series products. It is important that all persons using this device read and understand all the information contained within.

Please read thoroughly the safety considerations and warnings section.

Procedures for daily checkout and unit care are located in "Maintenance" on page 12-1.

This manual is supplemented by manual inserts for options available on the R Series. These inserts contain additional warnings, precautions, and safety-related information.



## Operator's Guide Updates

An issue or revision date for this manual is shown on the front cover. If more than three years have elapsed since this date, contact ZOLL Medical Corporation to determine if additional product information updates are available.

All users should carefully review each manual update to understand its significance and then file it in its appropriate section within this manual for subsequent reference.








Product documentation is available through the ZOLL website at [www.zoll.com](http://www.zoll.com). From the Products menu, choose Product Manuals.







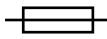







## Unpacking














Carefully inspect each container for damage. If the shipping container or cushion material is damaged, keep it until the contents have been checked for completeness and the instrument has been checked for mechanical and electrical integrity. If the contents are incomplete, if there is mechanical damage, or if the defibrillator does not pass its electrical self-test, U.S.A. customers should call ZOLL Medical Corporation (1-800-348-9011). Customers outside of the U.S.A. should contact the nearest ZOLL authorized representative. If the shipping container is damaged, also notify the carrier.


## Symbols Used on the Equipment

Any or all of the following symbols may be used in this manual or on this equipment:

Symbol	Description
	Dangerous voltage.
	MR unsafe: keep away from magnetic resonance imaging equipment
	Attention, consult accompanying documents.
	Fragile, handle with care.
	Keep dry.
	This end up.
	Temperature limitation.

Symbol	Description
	<b>Conformité Européenne</b> Complies with medical device directive 93/42/EEC.
	Type B patient connection.
	Type BF patient connection.
	Type CF patient connection.
	Defibrillator-proof type BF patient connection.
	Defibrillator-proof type CF patient connection.
	Fusible link.
	Equipotentiality.
	Alternating current (AC).
	Direct current (DC).
	Contains lithium. Recycle or dispose of properly.
	Keep away from open flame and high heat.
	Do not open, disassemble, or intentionally damage.
	Do not crush.

Symbol	Description
	Do not discard in trash. Recycle or dispose of properly.
	Return to a collection site intended for waste electrical and electronic equipment (WEEE). Do not dispose of in unsorted trash.
	Date of manufacture.
	Use by.
	Latex-free.
	Do not reuse.
	Do not fold.
	Not sterile.
	Nonionizing electromagnetic radiation from Wi-Fi during data transfer.
	Manufacturer.
	Authorized representative in the European Community.
	Serial Number.
	Catalogue number.
	Consult instructions for use.

Symbol	Description
<b>Rx ONLY</b>	Prescription only.
$E_{MAX} = 200J$	Maximum energy.
	Test port.

## Conventions

This guide uses the following conventions:

Within text, the names and labels for physical buttons and softkeys appear in **boldface** type (for example, “Press the **SHOCK** button or the **Code Marker** softkey”).

This guide uses uppercase italics for audible prompts and for text messages displayed on the screen (for example, *CHECK PATIENT*).

---

**WARNING!** Warning statements alert you to conditions or actions that can result in personal injury or death.

---



---

**Caution** Caution statements alert you to conditions or actions that can result in damage to the unit.

---

## Defibrillator Function

The R Series product contains a direct current (DC) defibrillator capable of delivering up to 200 joules. It may be used in synchronized mode to perform synchronized cardioversion using the patient’s R-wave as a timing reference. The unit uses paddles or disposable, pregelled electrodes for defibrillation.

### Intended Use — Manual Operation

In manual mode, the unit can also be used for synchronized cardioversion of certain atrial or ventricular arrhythmias. A qualified physician must decide when synchronized cardioversion is appropriate.

The advisory function should be used to confirm ventricular fibrillation or wide complex ventricular tachycardia (greater than 150 beats per minute) in patients meeting the three conditions indicating lack of circulation (listed above).

## **Intended Use — ECG Monitoring**

The unit is intended for use when ECG monitoring is indicated to evaluate the patient's heart rate or ECG morphology. In ECG monitoring mode, the unit is intended to be used by personnel who are qualified by training in the use of the R Series defibrillator, basic life and/or advanced life support, or other physician-authorized emergency medical training.

## **Intended Use — Real CPR Help**

The Real CPR Help function provides visual and audio feedback designed to encourage rescuers to perform chest compressions at the AHA/ERC recommended rate of 100 - 120 compressions per minute. Voice and visual prompts encourage a compression depth in accordance with AHA and/or ERC recommendations of 2 inches (5 cm) minimum for adult patients.

## **Defibrillator Complications**

Inappropriate defibrillation or cardioversion of a patient (for example, with no malignant arrhythmia) may precipitate ventricular fibrillation, asystole, or other dangerous arrhythmias.

Defibrillation without proper application of electrodes or paddle electrolyte gel might be ineffective and cause burns, particularly when repeated shocks are necessary. Erythema or hyperemia of the skin under the paddles, or electrodes often occurs; this effect is usually enhanced along the perimeter of the paddles or electrodes. This reddening should diminish substantially within 72 hours.

## **Defibrillator Output Energy**

R Series defibrillators can deliver as much as 200 joules into a 50 ohm impedance. The energy delivered through the chest wall, however, is determined by the patient's transthoracic impedance. An adequate amount of electrolyte gel must be applied to the paddles and a force of 10 to 12 kilograms (22 to 26.4 pounds) must be applied to each paddle in order to minimize this impedance. If hands-free therapy electrodes are used, make sure that they are properly applied. (Refer to the instructions on the electrode package).

## **External Pacemaker (Optional)**

Some R Series products include an optional transcutaneous pacemaker consisting of a pulse generator and ECG-sensing circuitry. Noninvasive transcutaneous pacing (NTP) is an established and proven technique. This therapy is easily and rapidly applied in both emergency and nonemergency situations when temporary cardiac stimulation is indicated.

The output current of the pacemaker is continuously variable from 0 to 140 mA. The rate is continuously variable from 30 to 180 pulses per minute (ppm), by increments of 2.

The pacing output pulse is delivered to the heart via ZOLL hands-free defibrillation/pacing electrodes placed on the patient's back and the precordium.

The characteristics of the output pulse, together with the design and placement of the electrodes, minimize cutaneous nerve stimulation, cardiac stimulation threshold currents, and reduce discomfort due to skeletal muscle contraction.

The unique design of the R Series products allow clear viewing and interpretation of the electrocardiogram on the display without offset or distortion during external pacing.

Proper operation of the device, together with correct electrode placement, is critical to obtaining optimal results. Every operator must be thoroughly familiar with these operating instructions.

## Intended Use — Pacemaker

This product can be used for temporary external cardiac pacing in conscious or unconscious patients as an alternative to endocardial stimulation.

The purposes of pacing include:

- Resuscitation from standstill or bradycardia of any etiology.

Noninvasive pacing has been used for resuscitation from cardiac standstill, reflex vagal standstill, drug-induced standstill (due to procainamide, quinidine, digitalis, b-blockers, verapamil, etc.) and unexpected circulatory arrest (due to anesthesia, surgery, angiography, and other therapeutic or diagnostic procedures). It has also been used for temporary acceleration of bradycardia in Stokes-Adams disease and sick-sinus syndrome. It is safer, more reliable, and more rapidly applied in an emergency than endocardial or other temporary electrodes.

- As a standby when standstill or bradycardia might be expected.

Noninvasive pacing can be useful as a standby when cardiac arrest or symptomatic bradycardia might be expected due to acute myocardial infarction, drug toxicity, anesthesia, or surgery. It is also useful as a temporary treatment in patients awaiting pacemaker implants or the introduction of transvenous therapy. In standby pacing applications, noninvasive pacing might provide an alternative to transvenous therapy that avoids the risks of displacement, infection, hemorrhage, embolization, perforation, phlebitis, and mechanical or electrical stimulation of ventricular tachycardia or fibrillation associated with endocardial pacing.

- Suppression of tachycardia.

Increased heart rates in response to external pacing often suppress ventricular ectopic activity and might prevent tachycardia.

---

**WARNING!** This device must not be connected to internal pacemaker electrodes.

---

## Pacemaker Complications

Ventricular fibrillation does not respond to pacing and requires immediate defibrillation. Therefore, the patient's dysrhythmia must be determined immediately, so that you can employ appropriate therapy. If the patient is in ventricular fibrillation and defibrillation is successful but cardiac standstill (asystole) ensues, you should use the pacemaker.

Ventricular or supraventricular tachycardias can be interrupted with pacing, but in an emergency or during circulatory collapse, synchronized cardioversion is faster and more certain.

Pulseless electrical activity (PEA) can occur following prolonged cardiac arrest or in other disease states with myocardial depression. Pacing might then produce ECG responses without effective mechanical contractions, making other effective treatment necessary.

Pacing can evoke undesirable repetitive responses, tachycardia, or fibrillation in the presence of generalized hypoxia, myocardial ischemia, cardiac drug toxicity, electrolyte imbalance, or other cardiac diseases.

Pacing by any method tends to inhibit intrinsic rhythmicity. Abrupt cessation of pacing, particularly at rapid rates, can cause ventricular standstill and should be avoided.

Noninvasive temporary pacing can cause discomfort of varying intensity, which occasionally can be severe and preclude its continued use in conscious patients.

Similarly, unavoidable skeletal muscle contraction might be troublesome in very sick patients and might limit continuous use to a few hours. Erythema or hyperemia of the skin under the hands-free therapy electrodes often occurs; this effect is usually enhanced along the perimeter of the electrode. This reddening should lessen substantially within 72 hours.

There have been reports of burns under the anterior electrode when pacing adult patients with severely restricted blood flow to the skin. Prolonged pacing should be avoided in these cases and periodic inspection of the underlying skin is advised.

There are reports of transient inhibition of spontaneous respiration in unconscious patients with previously available units when the anterior electrode was placed too low on the abdomen.

---

**WARNING!** This device must not be connected to internal pacemaker electrodes.

---

## Pediatric Pacing

Pacing can be performed on pediatric patients weighing 55 lb. (25 kg) or less using ZOLL pediatric hands-free therapy electrodes. Prolonged pacing (in excess of 30 minutes), particularly in neonates, can cause burns. Periodic inspection of the underlying skin is recommended.

## Intended Use — SpO<sub>2</sub> Monitoring

The R Series pulse oximeter, with the Masimo<sup>®</sup> SET<sup>®</sup> technology and the LNCS<sup>®</sup> series of oximeter sensors, is indicated for the continuous, noninvasive monitoring of arterial oxygen saturation (SpO<sub>2</sub>) and pulse rate during both no motion and patient motion conditions for adult patients, and no motion conditions for pediatric and neonatal patients in a hospital environment.

### SpO<sub>2</sub> Contraindications for Use

See the *R Series Pulse Oximetry (SpO<sub>2</sub>)* insert (ZOLL part number 9650-0901-01) for disclosures of any contraindications for use of the pulse oximeter monitoring feature.

## Intended Use — EtCO<sub>2</sub> Monitoring

The ZOLL R Series EtCO<sub>2</sub> option with Respironics Novamatrix technology is indicated for the continuous noninvasive monitoring of end tidal carbon dioxide (EtCO<sub>2</sub>) and respiration rate in patients requiring ventilator support, in-hospital transport, or anesthesia. The R Series EtCO<sub>2</sub> option with Respironics Novamatrix technology supports two methods for continuous measurement of end tidal carbon dioxide (EtCO<sub>2</sub>) and respiration rate.

The first method uses the CAPNOSTAT 5 Mainstream CO<sub>2</sub> sensor attached to an airway adapter that connects to an endotracheal tube, mask or disposable mouthpiece.

The second method uses the LoFlo CO<sub>2</sub> module to monitor both non-intubated and intubated patients using specially designed sampling cannulas and airway adapters.

The R Series EtCO<sub>2</sub> option is designed to monitor adult, pediatric, and neonatal patients.

The following substances can influence CO<sub>2</sub> measurements made with the CAPNOSTAT 5 CO<sub>2</sub> mainstream sensor or the LoFlo sidestream module:

- elevated oxygen levels
- nitrous oxide
- halogenated agents

The R Series EtCO<sub>2</sub> option provides settings for high oxygen and/or nitrous oxide compensation. Halogenated anesthetic agents alter CO<sub>2</sub> readings, but the R Series unit will monitor CO<sub>2</sub> within specifications when these agents are present at normal clinical levels. The presence of Desflurane in the exhaled breath beyond normal values (5%) may positively bias measured carbon dioxide values by up to an additional 3 mmHg.

The R Series EtCO<sub>2</sub> option is intended for use only with the ZOLL/Respironics Novamatrix CAPNOSTAT 5 Mainstream CO<sub>2</sub> Sensor and mainstream airway adapters, the LoFlo CO<sub>2</sub> Module, nasal and nasal/oral sampling cannula sets, and sidestream on-airway adapters.

The R Series EtCO<sub>2</sub> option can be used on adult patients (21 years of age and older) and on pediatric patients, as described in the following table:

Pediatric Subpopulation	Approximate Age Range
Newborn (neonate)	Birth to 1 month of age
Infant	1 month to 2 years of age
Child	2 to 12 years of age
Adolescent	12-21 years of age

### EtCO<sub>2</sub> Contraindications for Use

See the *R Series End Tidal Carbon Dioxide (EtCO<sub>2</sub>)* insert (ZOLL part number 9650-0915-01) for disclosures of any contraindications for use of the EtCO<sub>2</sub> monitoring feature.

## Intended Use — NIBP

The ZOLL R Series NIBP option is indicated for the non-invasive measurement of arterial blood pressure for resting patients in critical care and in-hospital transport.

The R Series NIBP option is designed to measure blood pressure for adult patients (21 years of age and older) and for pediatric patients, as described in the following table:



Pediatric Subpopulation	Approximate Age Range
Newborn (neonate)	Birth to 1 month of age
Infant	1 month to 2 years of age
Child	2 to 12 years of age
Adolescent	12-21 years of age

### NIBP Contraindications for Use

See the *R Series Non-Invasive Blood Pressure (NIBP)* insert (ZOLL part number 9650-0914-01) for disclosures of any contraindications for use of the NIBP monitoring feature.

## ECG Monitoring

The patient's ECG is monitored by connecting the patient to the unit via a 3- or 5-lead patient cable, hands-free therapy electrodes, or through paddles. Five seconds of ECG is presented on the display along with the following information:

- averaged heart rate, derived by measuring R to R intervals
- lead selection - I, II, III, aVR, aVL, aVF, V (with ECG cable), PADDLES or PADS, P1, P2, P3 (when using OneStep Pacing cable with OneStep Complete electrodes).

P1, P2, and P3 are non-standard ECG leads derived from electrodes within particular OneStep electrodes. While ECG signals acquired from these leads are appropriate for rhythm assessment and determining electrical capture during pacing, they should not be used for ECG morphological evaluation. Attach conventional ECG electrodes for diagnostic purposes.

- ECG size relative scale factor - x0.5, x1, x1.5, x2, x3
- other operational prompts, messages, and diagnostic codes

Monitoring or diagnostic ECG bandwidth is selectable.

## Recorder Function

The strip recorder is provided to document events. The strip recorder normally operates in the delay mode (6 seconds) to ensure the capture of ECG information immediately preceding critical events. The recorder may be activated manually by pressing the **RECORDER** button. It is activated automatically whenever a defibrillation **SHOCK** is delivered, a heart rate alarm occurs, or the rhythm analysis function is activated. The strip recorder may also be configured not to print during these events.

## Paddles and Electrodes

The R Series will defibrillate, cardiovert, and monitor ECG using either defibrillation paddles or hands-free therapy electrodes.

The pacer version of the R Series will pace using ZOLL hands-free therapy electrodes.

**ENERGY SELECT**, **CHARGE** and **SHOCK** controls are located on the paddles and front panel. When using hands-free therapy electrodes, you must use the controls on the front panel of the unit. To switch between paddles and hands-free therapy electrodes, remove the OneStep cable from the apex paddle and connect the hands-free therapy electrodes to the cable.

The Advisory function cannot be activated unless hands-free therapy electrodes are attached to the OneStep cable and used as the ECG monitoring lead.

The R Series can monitor the patient's ECG while pacing without the need for a separate ECG cable and ECG electrodes. This also allows demand pacing when separate ECG electrodes are either not connected, or unavailable. OneStep pacing capability requires the OneStep Pacing cable along with OneStep Pacing electrodes, or OneStep Complete electrodes.

**Note:** The ZOLL OneStep electrodes, MFE Pads, Pediatric MFE Pads, Stat-padz<sup>®</sup>, and ECG electrodes are disposable, single-use items.

You should always check the expiration date on the electrode packaging. Do not use expired electrodes, which might result in false patient impedance readings and affect the level of delivered energy, or cause burns.



This symbol on the electrode package is accompanied by the expiration date.

The R Series defibrillator reads and reports the expiration date for all OneStep electrodes (except for OneStep Basic). When these electrodes exceed their expiration date, the Code Readiness indicator will change to a red "X."

**Note:** ZOLL electrodes contain no hazardous materials and may be disposed of in general trash unless contaminated with pathogens. Use appropriate precautions when disposing of contaminated electrodes.

When the patient is less than 8 years old or weighs less than 55 lb. (25 kg), use ZOLL pediatric defibrillation electrodes. Do not delay therapy to determine the patient's exact age or weight.

## Batteries

R Series products use an easily replaced rechargeable lithium-ion battery pack (the ZOLL *SurePower* battery pack). A new, fully charged battery pack typically delivers more than 5 hours of ECG monitoring. Use of other functions (such as the defibrillator, printer, or pacemaker) reduces this time.

When a *LOW BATTERY* message appears on the display and the unit emits two beeps in conjunction with the displayed message, the battery must be replaced and recharged.

You can charge the battery by either of the following methods:

- **Internal charging** — plug the R Series into an AC power supply to automatically begin charging the installed battery pack. The front panel battery indicator operates as follows:

When the indicator is:	It means:
Steady yellow	Battery is charging
Steady green	Battery is charged

When the indicator is:	It means:
Alternating yellow and green	No battery is installed or a battery charging fault has been detected.
Not lit	The defibrillator is not connected to AC mains.

**Note:** Upon power up, it takes approximately 45 seconds for the LEDs on the battery to accurately display run time.

- **External charging** — use the ZOLL SurePower Battery Charger to charge the battery pack and test the battery's capacity. For details, refer to the *ZOLL SurePower defibrillator battery Operator's Manual*.

## Code-Ready System

The R Series defibrillator's Code-Ready system tests the defibrillator whenever the unit is turned on, periodically during operation, whenever manual testing is initiated by the operator, and automatically, at pre-configured intervals.

The code readiness indicator on the front panel shows the result of the most recent readiness check. Also, OneStep Pacing, CPR or Complete electrodes provide an interface that communicates the electrode's expiration date and condition to the defibrillator.

The Defib Test Log stores the results for as many as 1000 defibrillator tests in internal memory. Each log entry shows the time and date of the defibrillator test. The Defib Test Log can be printed on the stripchart or transferred to a personal computer for printing and archiving.

## Safety Considerations



All operators should review these safety considerations before using the R Series.

R Series products are high-energy defibrillators capable of delivering 200 joules. To completely deactivate the unit, turn the Mode Selector to OFF.

To manually disarm a charged (or charging) defibrillator, do one of the following:

- Turn the Mode Selector to **OFF**, **MONITOR**, or **PACER**.
- Change the selected defibrillator energy.

For safety, the R Series unit automatically disarms if left charged for more than either 60 or 120 seconds (user configurable) if the **SHOCK** button is not pressed.

## Warnings

### General

Federal (U.S.A.) law restricts this defibrillator to use by or on the order of a physician.

Only appropriately trained, skilled personnel who are familiar with equipment operation should perform emergency defibrillation. The prescribing physician should determine what training, such as Advanced Cardiac Life Support (ACLS) or Basic Life Support (BLS) certification, is appropriate.

Only skilled personnel trained in Advanced Cardiac Life Support (ACLS) and who are familiar with equipment operation should perform synchronized cardioversion. The precise cardiac arrhythmia must be determined before attempting defibrillation.

These operating instructions describe the functions and proper operation of the R Series products. They are not a substitute for a formal patient care training course. Operators should obtain formal training from an appropriate authority before using this defibrillator for patient care.

Proper operation of the unit and correct electrode placement is critical to obtaining optimal results. Operators must be thoroughly familiar with proper device operation.

The use of external pacing/defibrillation electrodes or adapter devices from sources other than ZOLL is not recommended. ZOLL makes no representations or warranties regarding the performance or effectiveness of its products when used with pacing/defibrillation electrodes or adapter devices from other sources. Defibrillator failures attributable to the use of pacing/defibrillation electrodes or adapters not manufactured by ZOLL might void ZOLL's warranty.

Do not disassemble the unit. A shock hazard exists. Refer all problems to authorized service personnel.

Follow all recommended maintenance instructions. If a problem occurs, obtain service immediately. Do not use the defibrillator until it has been inspected by appropriate personnel.

The R Series unit might not perform to specifications when stored at the upper or lower extreme limits of storage temperature and then immediately put into use.

Avoid using the R Series adjacent to, or stacked on, other equipment. If unavoidable, verify that the R Series operates normally in this configuration before clinical use.

The R Series should be installed and put into service according to the EMC information in Appendix A of this manual.

Assess the Wi-Fi performance for the possibility of RFI in your environment of use.

If multiple devices are transmitting simultaneously to the same access point, Wi-Fi data transfer will be slowed down. If the access point is too overloaded, data transmission failures can occur.

The use of accessories, transducers, and cables other than those specified in this manual and related R Series option manual inserts may result in increased emissions or decreased immunity of the R Series.

Do not use or place the unit in service if the Code Readiness indicator (at the upper right of the front panel) displays a red “X”.

Carefully route patient cables to avoid tripping over them, or inadvertently pulling the unit onto the patient.

Always inspect the unit for damage if it has been dropped.

To avoid risk of electric shock, this equipment must only be connected to a supply mains with protective earth.

Do not modify this equipment without authorization from the manufacturer.

Ensure that the unit is always positioned so as to allow unobstructed access to and detachment of the power cord from the unit to AC mains.

MR Unsafe: Keep the R Series defibrillator away from magnetic resonance imaging (MRI) equipment.

### **ECG Analysis, Defibrillating, Pacing and CPR**

Prior to attempting synchronized cardioversion, ensure the ECG signal quality is good and that sync markers are displayed above each QRS complex.

Do not use the unit in advisory mode during patient movement. A patient must be motionless during ECG rhythm analysis. Do not touch the patient during analysis. If transporting the patient in the hospital, cease all movement before beginning ECG analysis.

ECG rhythm analysis does not warn of patient asystole, which is not a shockable rhythm.

The ECG rhythm analysis function might not reliably identify ventricular fibrillation in the presence of an implanted pacemaker. Inspection of the electrocardiogram and clinical evidence of cardiopulmonary arrest should be the basis for any treatment of patients with an implanted pacemaker.

Implanted pacemakers might cause the heart rate meter to count the pacemaker rate during incidents of cardiac arrest or other arrhythmias. Dedicated pacemaker detection circuitry may not detect all implanted pacemaker spikes. Check the patient's pulse; do not rely solely on heart rate meters. Patient history and physical examination are important factors in determining the presence of an implanted pacemaker. Pacemaker patients should be carefully observed.

Do not place electrodes directly over an implanted pacemaker.

The R Series unit detects ECG electrical signals only. It does not detect a pulse (effective circulatory perfusion). Always verify pulse and heart rate by physical assessment of the patient. Never assume that the display of a nonzero heart rate means that the patient has a pulse.

To avoid possible damage to the R Series unit, turn off pacing before defibrillating the patient with a second defibrillator.

Do not use the unit's ECG-out signal as a synchronization pulse for another defibrillator or cardioverter.

Place the patient on a firm surface before performing CPR.

### **Battery**

Do not operate the unit without a battery. Always have a source of available backup power for all anticipated use environments. A fully charged spare battery or ready access to AC mains power from a local wall outlet can provide this backup power.

Test battery packs regularly. A battery that does not pass the ZOLL charger's capacity test might cause the R Series unit to shut down unexpectedly.

When the warning *LOW BATTERY* appears, plug the R Series unit into a power source or install a fully charged battery pack. When the warning *REPLACE BATTERY* appears, immediately replace the battery pack with a fully charged pack or plug the R Series unit into a power source, as unit shut down due to a low battery condition is imminent.

If mistreated, a battery pack might explode. Do not disassemble a battery pack or dispose of it in fire.

## **Operator Safety**



Do not use R series products in the presence of oxygen-rich atmospheres, flammable anesthetics, or other flammable agents (such as gasoline). Using the unit in such environments might cause an explosion.

Do not use the unit near or within standing water. Electrical safety might be compromised when the defibrillator is wet.

Never discharge the unit with the defibrillation electrodes or paddles shorted together or in open air.

Do not discharge the defibrillator except as indicated in the instructions. Discharge the defibrillator only when defibrillation electrodes or paddles are properly applied to the patient.

To avoid risk of electrical shock, do not touch the gelled area of the hands-free therapy electrodes during pacing or defibrillation.

To avoid risk of electrical shock, do not allow electrolyte gel to accumulate on hands or paddle handles.

To avoid risk of electrical shock, do not allow patient connectors to contact other conductive parts, including earth.

For defibrillation using paddles, use only high-conductivity electrolyte gel specified for such use by the manufacturer.

When using paddles for defibrillation, use your thumbs to operate the **SHOCK** buttons. Doing so avoids inadvertent shock to the operator and unintentional depression of an **ENERGY SELECT** button, which causes the defibrillator to disarm. Keep your hands and fingers away from the paddle plates.

The use of accessory equipment that does not comply with the equivalent safety requirements of the R Series defibrillator could reduce the level of safety of the combined system. When choosing accessory equipment, consider the following:

- Use of the accessory in the patient vicinity.
- Evidence that the safety certification of the accessory has been performed in accordance with the appropriate IEC (EN) 60601-1 and/or IEC (EN) 60601-1-1 harmonized national standards.

Always check that the equipment functions properly and is in proper condition before use.

Disconnect all electro-medical equipment that is not defibrillation-protected from the patient prior to defibrillation.

Before discharging the defibrillator, warn everyone to **STAND CLEAR** of the patient.

Do not touch the bed, patient, or any equipment connected to the patient during defibrillation. A severe shock can result. To avoid hazardous pathways for the defibrillation current, do not allow exposed portions of the patient's body to touch any metal objects, such as a bed frame.

When the R Series is performing a Code Readiness test, as indicated on the display, do not touch the connected paddles, electrodes, or OneStep cable connector.

## Patient Safety



This equipment should be connected to only one patient at a time.

Use only OneStep Pediatric electrodes to defibrillate patients under 8 years of age in Advisory modes. Use of adult electrodes, or pediatric electrodes other than OneStep Pediatric electrodes, can result in the delivery of excessive energy doses.

Neonatal and pediatric defibrillation energy level settings should be based on site-specific clinical protocols.

To ensure patient safety, connect the R Series only to equipment with galvanically isolated circuits.

Use only high-quality ECG electrodes. ECG electrodes are for rhythm acquisition only; you cannot use ECG electrodes for defibrillation or pacing.

Do not use therapy or ECG electrodes if the gel is dried, separated, torn or split from the foil; patient burns may result from using such electrodes. Poor adherence and/or air pockets under therapy electrodes can cause arcing and skin burns.

Check the expiration date on the electrode packaging. Do not use electrodes after their expiration date.

Excessive body hair or wet, diaphoretic skin can inhibit electrode coupling to the skin. Clip excess hair and dry any moisture from the area where an electrode is to be attached.

Therapy electrodes should be replaced periodically during continuous pacing. Consult electrode directions for proper replacement instructions.

Prolonged pacing (more than 30 minutes), particularly in neonates or adults with severely restricted blood flow, may cause burns. Periodically inspect the skin under the electrodes.

Carefully route the patient cables to reduce the possibility of patient entanglement or strangulation.

To avoid electrosurgery burns at monitoring sites, ensure proper connection of the electrosurgery return circuit so that a return path cannot be made through monitoring electrodes or probes.

During electrosurgery, observe the following guidelines to minimize electrosurgery unit (ESU) interference and provide maximum operator and patient safety:

- Keep all patient monitoring cables away from earth ground, ESU knives, and ESU return wires.

- Use electrosurgical grounding pads with the largest practical contact area.

Always ensure proper application of the electrosurgical return electrode to the patient.

Check electrical leakage levels before use. Leakage current may be excessive if more than one monitor or other piece of equipment is connected to the patient.

Do not use the ZOLL OneStep Pacing cable (**REF** 1009-0913-02) or the ZOLL Multi-Function Cable (**REF** 1009-0913-03) in a 220/240 VAC 60Hz power environment. Patient leakage current may be excessive.

Do not place the unit in contact with a patient. Burns may result.

## Cautions

If the unit is to be stored longer than 90 days, remove the battery pack.

Do not sterilize the defibrillator, or its accessories unless the accessories are labelled as sterilizable.

Do not immerse any part of the defibrillator in water.

Do not use ketones (such as acetone or MEK) on the defibrillator.

Avoid using abrasives (including paper towels) on the display window.

To protect the unit from damage during defibrillation, for accurate ECG information, and to protect against noise and other interference, use only internal current-limiting ECG cables specified or supplied by ZOLL.

For continued safety and EMI performance, use only the line cord supplied by ZOLL.

Dispose of battery packs in accordance with national, regional and local regulations. Battery packs should be shipped to a reclamation facility for recovery of metal and plastic compounds as the proper method of waste management.

## Restarting the Defibrillator

Certain events require the R Series products to be restarted after they shut off or become inoperative (for example, when the battery runs down and the unit shuts off).

In such a case, always try to restore defibrillator operation as follows:

1. Turn the Mode Selector to **OFF**.
2. If necessary, replace a depleted battery with a fully charged pack, or connect the defibrillator to AC mains.
3. Turn the Mode Selector to the desired operating mode to restart the unit.

This sequence is necessary to restart the defibrillator and can also be used to clear some fault messages when immediate use of the defibrillator is required.

If restarted after a shutdown period of 10 seconds or more, the unit restores all settings (such as ECG lead, ECG size, and alarm state and limits) to their power-up default values. After restoring device operation, you might need to reinstate previously selected, non-default settings.



## FDA Tracking Requirements

U.S. Federal Law (21 CFR 821) requires the tracking of defibrillators. Under this law, owners of this defibrillator must notify ZOLL Medical Corporation if this product is

- received
- lost, stolen, or destroyed
- donated, resold, or otherwise distributed to a different organization

If any such event occurs, contact ZOLL Medical Corporation in writing with the following information:

1. Originator's organization – Company name, address, contact name, and contact phone number
2. Model number, and serial number of the defibrillator
3. Disposition of the defibrillator (for example, received, lost, stolen, destroyed, distributed to another organization), new location and/or organization (if known and different from originator's organization) – company name, address, contact name, and contact phone number
4. Date when the change took effect

Please address the information to:

**ZOLL Medical Corporation**  
**Attn: Tracking Coordinator**  
**269 Mill Road**  
**Chelmsford, MA 01824-4105**

Fax: (978) 421-0025

Telephone: (978) 421-9655

## Notification of Adverse Events

As a health care provider, you may have responsibilities under the Safe Medical Devices Act (SMDA), for reporting to ZOLL Medical Corporation, and possibly to the FDA, the occurrence of certain events.

These events, described in 21 CFR Part 803, include device-related death and serious injury or illness. In addition, as part of our Quality Assurance Program, ZOLL Medical Corporation requests to be notified of device failures or malfunctions. This information is required to ensure that ZOLL Medical Corporation provides only the highest quality products.

## Software License

**Note:** Read this Operator's Guide and License agreement carefully before operating any of the R Series products.

Software incorporated into the system is protected by copyright laws and international copyright treaties as well as other intellectual property laws and treaties. This software is licensed, not sold. By taking delivery of and using this system, the Purchaser signifies agreement to and acceptance of the following terms and conditions:

1. **Grant of License:** In consideration of payment of the software license fee which is part of the price paid for this product ZOLL Medical Corporation grants the Purchaser a non-exclusive license, without right to sublicense, to use the system software in object-code form only.
2. **Ownership of Software/Firmware:** Title to, ownership of and all rights and interests in the system software and all copies thereof remain at all times vested in the manufacturer, and Licensors to ZOLL Medical Corporation and they do not pass to purchaser.
3. **Assignment:** Purchaser agrees not to assign, sublicense or otherwise transfer or share its rights under the license without the express written permission of ZOLL Medical Corporation.
4. **Use Restrictions:** As the Purchaser, you may physically transfer the products from one location to another provided that the software/firmware is not copied. You may not disclose, publish, translate, release or distribute copies of the software/firmware to others. You may not modify, adapt, translate, reverse engineer, decompile, crosscompile, disassemble or create derivative works based on the software/firmware.

### NO IMPLIED LICENSE

Possession or purchase of this device does not convey any express or implied license to use the device with replacement parts which would, alone, or in combination with this device, fall within the scope of one or more of the patents relating to this device.

## Service

The R Series does not require periodic recalibration or adjustment. Appropriately trained and qualified personnel should, however, perform periodic tests of the defibrillator to verify proper operation.

If a unit requires service, contact the ZOLL Technical Service Department.

For customers In the U.S.A.	For customers outside the U.S.A.
Telephone: 1-800-348-9011 1-978-421-9655  Fax: 1-978-421-0010	Call the nearest authorized ZOLL Medical Corporation representative.  To locate an authorized service center, contact the International Sales Department at  ZOLL Medical Corporation 269 Mill Road Chelmsford, MA 01824-4105  Telephone: 1-978-421-9655

When requesting service, please provide the following information to the service representative:

- Unit serial number
- Description of the problem
- Department using the equipment and name of the person to contact
- Purchase order to allow tracking of loan equipment
- Purchase order for a unit with an expired warranty
- Sample ECG or other stripcharts demonstrating the problem (if available and applicable), less any confidential patient information.

**Returning a unit for service**

Before sending a unit to the ZOLL Technical Service Department for repair, obtain a service request (SR) number from the service representative.

Remove the battery pack from the unit. Pack the unit with its cables and battery in the original containers (if available) or equivalent packaging. Be sure the assigned service request number appears on each package.

For customers	Return the unit to
In the U.S.A.	ZOLL Medical Corporation 269 Mill Road Chelmsford, MA 01824-4105  Attention: Technical Service Department ( <i>SR number</i> )  Telephone: 1-800-348-9011
In Canada	ZOLL Medical Canada Inc. 1750 Sismet Road, Unit #1 Mississauga, ON L4W 1R6  Attention: Technical Service Department ( <i>SR number</i> )  Telephone: 1-866-442-1011
In other locations	The nearest authorized ZOLL Medical Corporation representative.  To locate an authorized service center, contact the International Sales Department at  ZOLL Medical Corporation 269 Mill Road Chelmsford, MA 01824-4105  Telephone: 1-978-421-9655

## The ZOLL Serial Number

Each ZOLL product displays a serial number that contains information about that product. From left to right, ZOLL serial numbers are structured as follows:

- A two-character product code
- A three-character date-of-manufacture code
- A product serial number of six or more alphanumeric characters

The product code for the R Series defibrillator is AF.

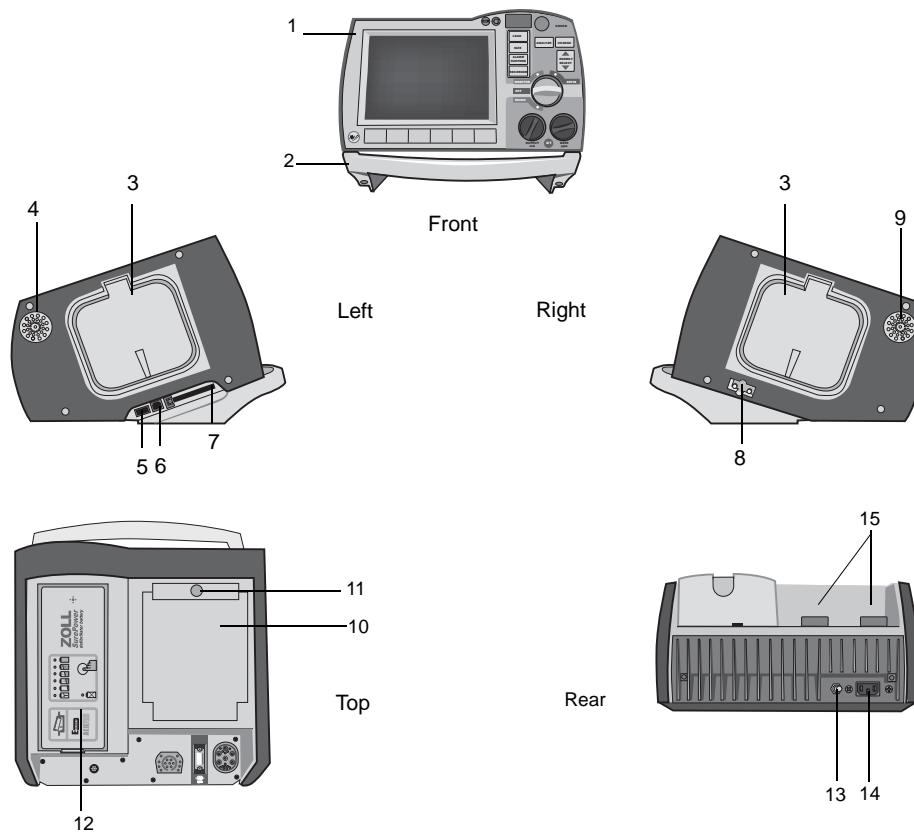
The first two characters of the date-of-manufacture code give the last two digits of the year (for example, “06” appears for products manufactured in 2006). The last character of the date-of-manufacture code gives the month in which the product was manufactured. The month appears in the form of a single alphanumeric character: “A” for January, “B” for February, “C” for March, and so on through “L” for December.

The product serial number is a unique set of alphanumeric characters that ZOLL assigns to each individual unit.

# Chapter 2

## Product Overview

### Defibrillator Controls and Indicators

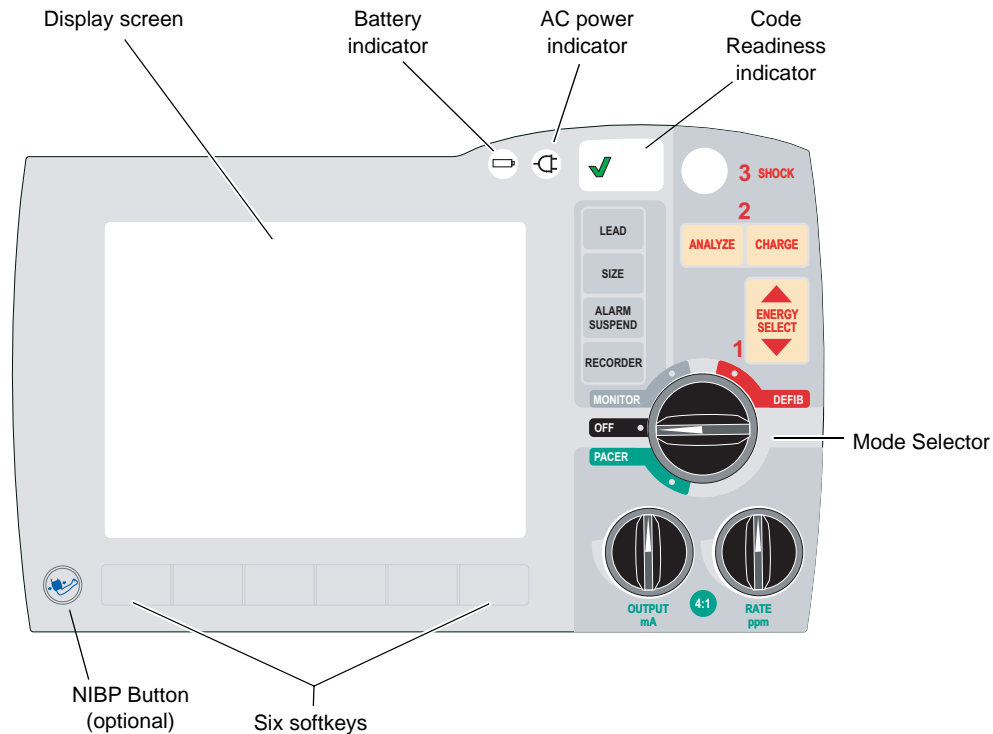


**Table 2-1. R Series Unit Features**

	<b>Item</b>	<b>Description</b>
1	Front panel	Includes the display screen and primary controls.
2	Handle	Integrated carrying handle.
3	External paddle well	Holds paddles when not in use. Allows defib self-test when paddles are stowed in their respective wells.
4	Beeper	Emits R-wave detection beeps, defib charge Ready tones, and alarm tones.
5	USB host connector (Optional)	(Reserved for future use — do not connect to any equipment.)
6	USB device connector	For connecting the R Series defibrillator to a USB device. For details, refer to “Event Records and Reports” on page 10-1.
7	Data card slot	Holds a compact flash card for copying data stored in the device’s internal memory. Accepts a CF memory card or a WiFi card.
8	Defibrillator test port	When not using OneStep electrodes or paddles, connect the patient end of a OneStep cable to this port to allow device checks.
9	Speaker	Issues voice prompts.
10	Paper Compartment	Holds the paper for the stripchart printer.
11	RELEASE button	Allows access to the paper compartment.
12	Battery compartment	Holds a rechargeable lithium ion battery pack.
13	Grounding post	Earth-grounded terminal provided for the convenient connection of biomedical test equipment requiring an equipotential ground. This terminal has no clinical function and should not be used for electrical safety purposes.
14	AC mains connector	For connecting the device to an AC power source.
15	Patient connectors	For details, refer to “Patient Cables and Connectors” on page 2-7.

## The Front Panel

The front panel of the R Series device includes the display screen, softkeys, battery indicator, AC power indicator, Code Readiness indicator, **SHOCK** button, and control panel. The control panel configuration varies slightly depending on the model. See Figure 2-1.





**Figure 2-1. R Series Front Panel**

Table 2-2 describes the controls and indicators that appear on the front panel.

**Table 2-2. R Series Controls and Indicators**

Control or Indicator	Description
Display screen	Shows therapeutic settings, physiological waveforms, and other information for each monitored parameter, messages, time, and softkey labels.
Battery indicator	Indicates battery status: Steady yellow: Battery is charging. Steady green: Battery is charged. Alternating yellow and green: No battery is installed, or there is a battery charging fault.
Indicator for AC power	Illuminated when the unit is plugged into an alternating current (AC) power source.
Code Readiness indicator	Shows the status of the unit, based on its most recent Readiness check: <ul style="list-style-type: none"> <li>A green “✓” indicates the unit is ready for therapeutic use.</li> <li>A red “X” indicates the unit’s Readiness is compromised and that it may not be ready for therapeutic use.</li> </ul>

**Table 2-2. R Series Controls and Indicators (continued)**

Control or Indicator	Description
Mode Selector	Selects the mode of operation (available options depend on model): <ul style="list-style-type: none"> <li>• OFF — Unit is powered off.</li> <li>• MONITOR — Physiological monitoring (ECG and other options)</li> <li>• DEFIB — Manual or advisory defibrillation</li> <li>• PACER — Noninvasive external pacing</li> </ul>
ENERGY SELECT Buttons	Two sets of up-down arrow buttons control the selection of defibrillator energy, one set located on the front panel and the other located on the sternum paddle.
CHARGE Button	Charges the defibrillator to the selected energy. In addition to the <b>CHARGE</b> button on the front panel, there is one located on the apex paddle handle.
SHOCK Button	The front panel <b>SHOCK</b> button is only active when using OneStep electrodes, hands-free therapy electrodes (see “R Series Accessories” on page B-1 for a list), external autoclavable paddles, or internal defibrillation paddles without a discharge button. The <b>SHOCK</b> button illuminates when the device is charged and ready.  To discharge the defibrillator when using paddles (internal or external) with discharge buttons, press and hold the <b>SHOCK</b> buttons on the paddles.
ANALYZE Button	Initiates ECG analysis to determine whether or not a shockable rhythm is present.
LEAD Button	Selects the ECG source for display and printing. Pressing this button sequentially selects ECG signals derived from each of the following lead configurations: I, II, III, aVR, aVL, aVF, PADDLES, or PADS, P1, P2, and P3 (when using OneStep Pacing electrodes, or OneStep Complete electrodes with OneStep Pacing cable) for display. The PADS or PADDLES lead setting is automatically selected when the defibrillator powers up in DEFIB or MONITOR mode with either hands-free therapy electrodes or paddles attached to the OneStep cable. Lead II or P3 (OneStep Pacing) is automatically selected when the R Series is powered up in PACER mode. Pads or Paddles monitoring is not available in PACER mode.
SIZE Button	Selects the relative amplitude scale factor for the displayed ECG waveform. Available scale factors are x0.5, x1, x1.5, x2 and x3
ALARM SUSPEND Button	Activates, deactivates or audibly suspends all alarm functions. A bell symbol (  ) appears on the display when alarms are enabled. When alarms are either audibly or permanently disabled, an “X” appears across the bell (  ) symbol.
RECORDER Button	Starts or stops the stripchart recorder. You can switch the unit to diagnostic ECG bandwidth (0.05 - 150Hz) by pressing and holding the <b>RECORDER</b> button. Diagnostic bandwidth is maintained as long as the <b>RECORDER</b> button is held down. When the <b>RECORDER</b> button is released, the unit reverts to standard monitoring bandwidth.
PACER OUTPUT mA (optional)	When pacing is selected, this control sets the amount of current delivered. The selected current setting is indicated on the display.
PACER RATE ppm (optional)	When pacing is selected, this control sets the rate (pulses per minute) at which the pacemaker will operate. The selected pace rate setting is indicated on the display.



**Table 2-2. R Series Controls and Indicators (continued)**

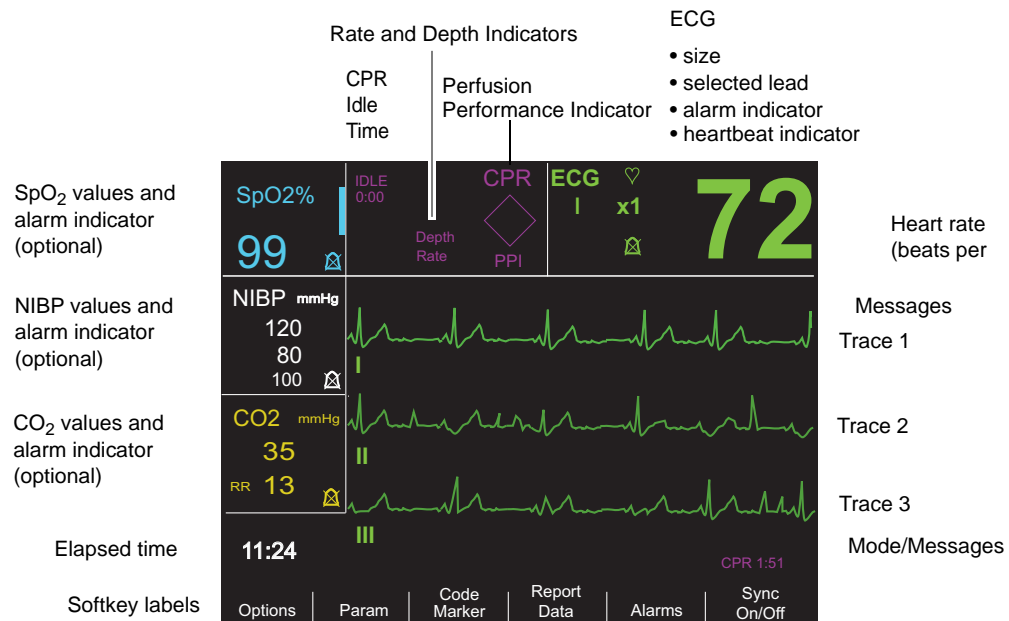
Control or Indicator	Description
4:1 Button (optional)	This button is used to determine a patient's underlying ECG rhythm. While depressed, this button causes pacing stimuli to be delivered at $\frac{1}{4}$ of the indicated ppm setting. When the button is released, normal pacing resumes.
NIBP Button (optional)	Allows you to start single, auto, or STAT non-invasive blood pressure measurements as described in the option insert <i>Non-Invasive Blood Pressure</i> (part number 9650-0914-01). Your unit has this button only if you ordered this configuration.
Softkeys	Six unlabeled buttons located directly below the display control different functions depending on the operating mode of the unit.  Labels for the softkeys appear at the bottom of the display directly above each softkey to indicate its function.
Charge Indicator Light (not shown)	Located on the apex paddle, this light turns on when the defibrillator is charged and ready.

## Display Screen

The front panel includes a color display which shows:

- The elapsed time (since the unit was turned on).
- The ECG trace, selected lead, size, heartbeat indicator, and alarm status.
- The selected energy, charging status, and delivered energy for defibrillation and synchronized cardioversion.
- The output current and stimulus rate for pacing.
- The measured SpO<sub>2</sub> percent saturation, signal strength, plethysmographic trace (if applicable), and alarm status indicators for optional SpO<sub>2</sub> monitoring.
- Non-invasive blood pressure (NIBP) readings: diastolic, systolic, and mean, plus alarm status indicators (optional; refer to the insert *Non-Invasive Blood Pressure (NIBP)*, part number 9650-0914-01).
- The patient's carbon dioxide level, respiration rate and capnogram (if applicable), and alarm status indicators for CO<sub>2</sub> monitoring (optional; refer to the insert *End Tidal Carbon Dioxide (EtCO<sub>2</sub>)*, part number 9650-0915-01).
- Messages and prompts.
- Labels above the softkeys (appropriate to the context).
- Perfusion Performance Indicator™ and Release Bar.
- CPR Rate and Depth.

Figure 2-2 shows the layout of parameter values, waveforms, system data, and softkey labels.



**Figure 2-2. R Series Display Screen (shown with optional SpO<sub>2</sub>, NIBP and CO<sub>2</sub> monitoring)**

**Color coding**

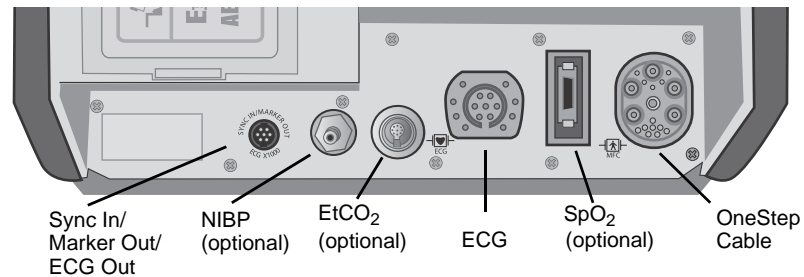
To differentiate information for various parameters, the unit displays each type of information in a specific user-configurable color.

**Messages**

During operation, a fault or error message is displayed when a fault is detected. If this occurs, turn the unit off and then on and recheck operation. If the fault persists, contact your authorized ZOLL agent as described on page 1-21.

## Patient Cables and Connectors

The back of the unit includes a set of connectors for patient cables.



**Figure 2-3. Patient Cable Connectors**

Connector	Description
OneStep Cable	For connecting paddles or ZOLL hands-free therapy and pacing electrodes using either OneStep or OneStep Pacing cables.
ECG	For connecting 3- or 5-lead ECG cable or OneStep Pacing cable's ECG cable.
Sync In / Marker Out / ECG x1000	Connector for <ul style="list-style-type: none"> <li>An incoming defibrillator synchronization signal from an external patient monitor.</li> <li>Output of R wave marker to an external patient monitor.</li> <li>ECG signal output for use with other equipment such as patient monitors and radio telemetry equipment (1 V/cm of displayed ECG signal).</li> </ul>
NIBP	(Optional) For connecting blood pressure cuff cable.
EtCO <sub>2</sub>	(Optional) For connecting CO <sub>2</sub> monitor cable.
SpO <sub>2</sub>	(Optional) For connecting pulse oximeter cable.

### OneStep Cables

The R Series ships with either a OneStep, or OneStep Pacing cable.

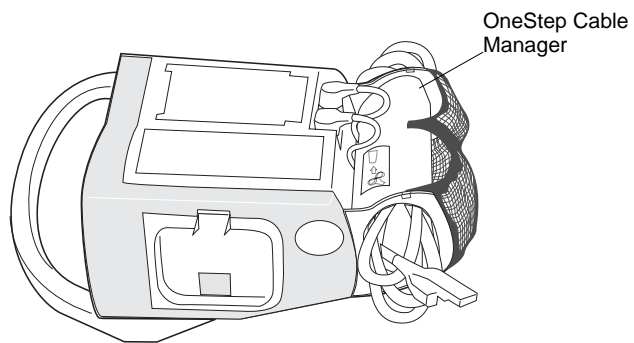
The OneStep Pacing cable has an additional connector that plugs into the rear panel ECG connector. This cable is used with OneStep Pacing electrodes or OneStep Complete electrodes for external pacing and ECG monitoring. Alternatively, you can disconnect the OneStep Pacing cable from the ECG connector and use a 3- or 5-lead ECG cable.



**Figure 2-4. OneStep Cables**

**OneStep Cable Manager (Optional)**

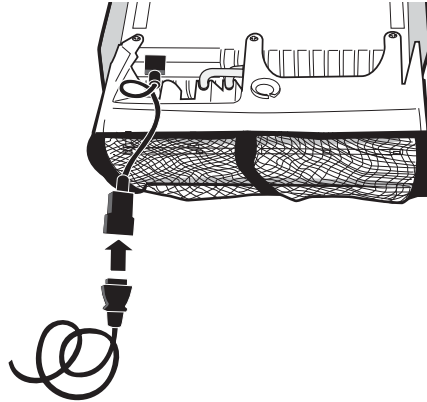
As an option, the OneStep Cable Manager is available to store and organize cables.



**Figure 2-5. The R Series with the Optional OneStep Cable Manager (Side View)**

## Power Cord

The AC power cord is used to operate the R Series unit when battery power is not being used. An additional extension cord is available for use when the cable organizer accessory is attached to the unit. The extension cord plugs into the main AC power cord as shown below.



## External Paddles



Paddles are defibrillation-proof Type BF equipment.

The external paddles on the R Series device are used for defibrillation and synchronized cardioversion.

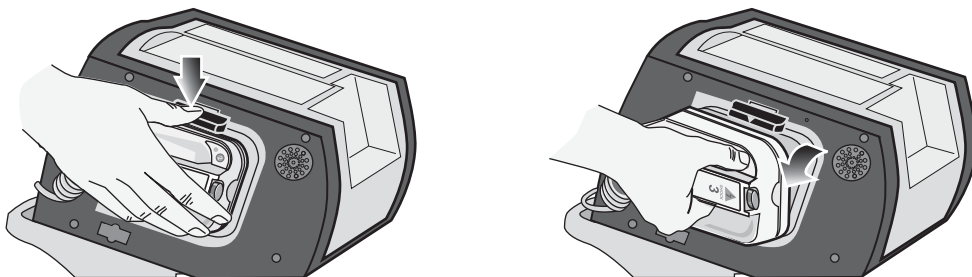
---

**Caution** You cannot use paddles for ECG analysis or pacing.

---

Defibrillation paddles can be used for ECG monitoring when it is not practical to apply ECG electrodes. Press the **LEAD** button to select PADDLES as the ECG source.

The paddles are stowed in wells on either side of the unit. To release the paddles, grasp the handles and then press down on the latch button above each paddle.



**Figure 2-6. Releasing the Paddles**

Attach the OneStep cable from the R Series unit to the connector at the base of the apex paddle.

1. Align OneStep cable as shown.

2. Insert OneStep cable into APEX paddle.



Figure 2-7. Attaching the OneStep Cable to the APEX Paddle

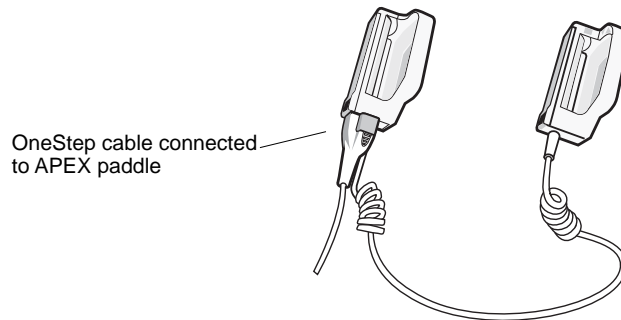


Figure 2-8. OneStep Cable Connected to APEX Paddle

If you need to detach the OneStep cable from the APEX paddles, push the **RELEASE** button (see Figure 2-9) in the direction of the arrow and unplug the OneStep cable.

Refer to Chapter 3, "Manual Defibrillation" before using paddles for defibrillation. The paddles include controls for selecting defibrillation energy, charging, delivering a shock, and turning the stripchart recorder on and off.

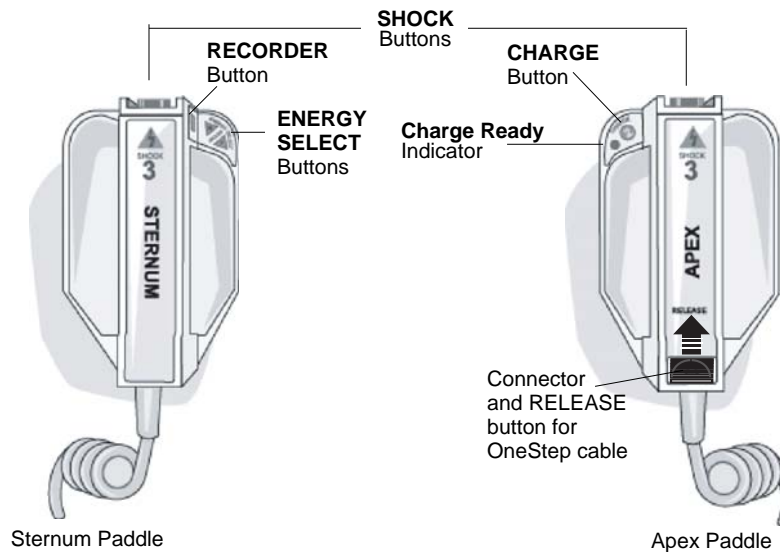
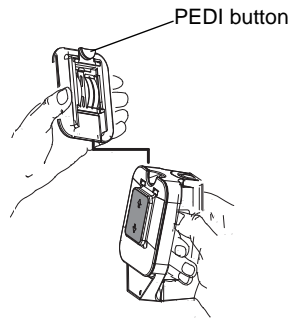


Figure 2-9. External Paddles

Pediatric-size electrodes are built into the paddle assembly beneath the standard electrode plates. The user must manually adjust energy settings to pediatric levels consistent with their institution’s protocols.



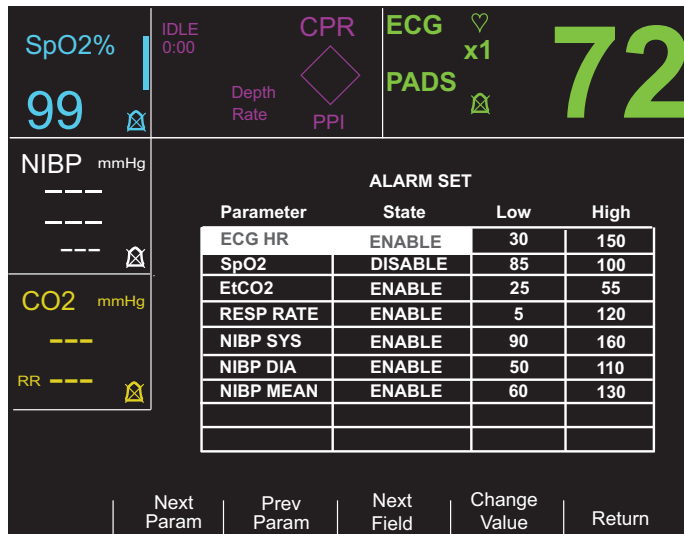
To expose the pediatric plate, press the PEDI button at the top of the paddle, then slide the Adult plate upward. Before replacing the Adult plate, be sure to clean the pediatric plate and surrounding area thoroughly. Slide the Adult plate onto the paddle until it locks into place.

**Figure 2-10. Pediatric Plate**

**Note:** The R Series defibrillator also supports ZOLL autoclavable internal handles for use during open chest defibrillation procedures.

## Working with Menus

For some functions, the screen shows a menu of options with related softkeys for navigating through the menus and making selections and entries.



**Figure 2-11. Example Display Screen**

On the display, highlighting indicates the currently selected item, that is, the item or value you are working with.

The following table summarizes some of the more common softkeys.

Softkey	Action
<b>Next Item</b> <b>Next Field</b>	Moves the highlighting down to the next item in a vertical list.
<b>Prev Item</b>	Moves the highlighting up to the previous item in a vertical list.
<b>Next Digit</b>	Moves the highlighting to the right in a series of letters or digits.
<b>Prev Digit</b>	Moves the highlighting to the left in a series of letters or digits.
<b>Inc</b> <b>Inc Digit</b>	Increases the highlighted value or digit. (For example, changes 2 to 3 or B to C).
<b>Dec</b> <b>Dec Digit</b>	Decreases the highlighted value or digit. (For example, changes 2 to 1 or B to A).
<b>Newer</b>	Moves the highlighting to the adjacent item with the more recent date or time.
<b>Older</b>	Moves the highlighting to the adjacent item with the older date or time.
<b>Enter</b>	Accepts the settings with the values currently shown.
<b>Return</b>	Displays the previous menu.
<b>Next Param</b>	Moves the highlighting to the next parameter.
<b>Prev Param</b>	Moves the highlighting to the previous parameter.
<b>Change Value</b>	Changes the value of the selected parameter.

## Defib Mentor Mode (Optional)

Defib Mentor™ mode is a nonclinical tutorial mode available when the Mode Selector is turned to MONITOR. When in this mode, the device displays a brief description of each front panel control's function when that control is activated.

**Note:** Do not run the Defib Mentor mode with a patient connected to the R Series unit.

To access Defib Mentor mode:

1. Turn the Mode Selector to **MONITOR**.
2. Press the **Options** softkey.
3. Press **MORE**.  
Additional options appear.
4. Press **Mentor**.
5. Press **Confirm Mentor Mode**.  
The unit is now in Defib Mentor Mode, a non-clinical operating mode.
6. Activate a front panel control (except the Mode Selector or the **Exit Mentor** softkey).  
A brief description of that control's function appears on the screen.

To exit Mentor mode, press the **Exit Mentor** softkey or turn the Mode Selector to **OFF**, **DEFIB**, or **PACER**.

**Note:** After 60 seconds of non use in the Mentor mode, the R Series returns to MONITOR mode.



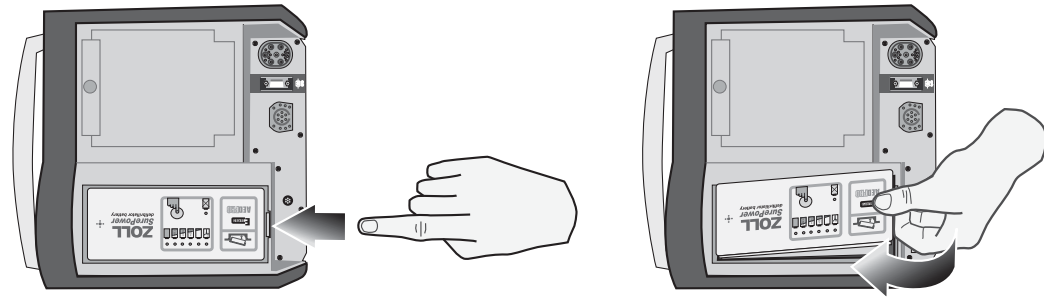
## Common Tasks

Follow the instructions in the subsequent sections for:

- “Replacing a Battery Pack” on page 2-13.
- “Adjusting Display Brightness” on page 2-13.
- “Using Code Markers” on page 2-14.

### Replacing a Battery Pack

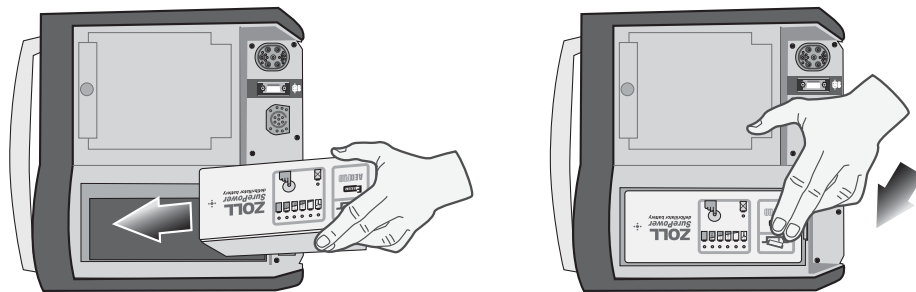
To remove a battery pack, press the tab on the end of the battery pack inward, and lift the battery pack out of the compartment.



**Figure 2-12. Removing a Battery Pack**

To install a battery pack:

1. Place the end of the battery pack opposite the tab into the end of the compartment closest to the front of the unit.
2. Lower the tabbed end of the battery pack into the compartment and press down on the tabbed end until it locks into place.



**Figure 2-13. Installing a Battery Pack**

### Adjusting Display Brightness

To adjust brightness:

1. Press the **Options** softkey.

2. Press the **High Bright** or **Low Bright** softkey to select high and low brightness.

**Note:** Brightness level affects battery run time. Selecting high bright will cause the battery charge to be depleted at a faster rate than when selecting low bright.

## Using Code Markers

Pressing the **CODE MARKER** softkey causes the unit to display a preconfigured list of clinical actions. Pressing the softkey associated with a particular action causes that action, and 6 seconds of ECG, to be recorded along with a date and time stamp in the Summary Report memory. You can supplement an event summary by manually adding code markers which itemize drugs or treatments administered to the patient.

Up to six Code Markers can be displayed on the screen at one time.



**Figure 2-14. Code Markers**

The right-most softkey is labeled MORE when there are more than six items on the code marker list. Press the MORE softkey to see the next set of Code Markers displayed above the softkeys.

Separate code marker lists are maintained for DEFIB, MONITOR, and PACER modes, thereby enabling the display of appropriate code markers for each particular protocol. (For information on configuring these code marker lists, refer to the *R Series Configuration Guide*.)

The code markers are removed from the display after 10 seconds. If no Code Marker softkey has been pressed during that time, a “default” event mark is stored in Summary Report memory.

# Chapter 3

## Manual Defibrillation

---



Paddles are a defibrillation-protected Type BF patient connection.



ECG leads are a defibrillation-protected Type CF patient connection.

### Emergency Defibrillation Procedure with Paddles

---

**WARNING!** To avoid risk of electrical shock, do not allow electrolyte gel to accumulate on hands or paddle handles.

When defibrillating with paddles, use your thumbs to operate the **SHOCK** buttons in order to avoid inadvertent operator shock. No portion of the hands should be near the paddle plates.

---

### Determine the Patient's Condition Following Local Medical Protocols

Verify:

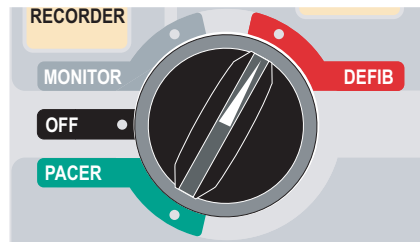
- Unconsciousness.
- Absence of breathing.
- Absence of pulse.

## Begin CPR Following Local Medical Protocols.

Request additional assistance.

### 1 Select DEFIB

Turn the Mode Selector to **DEFIB**. The unit automatically defaults to 120 joules or the preconfigured first shock energy selection.



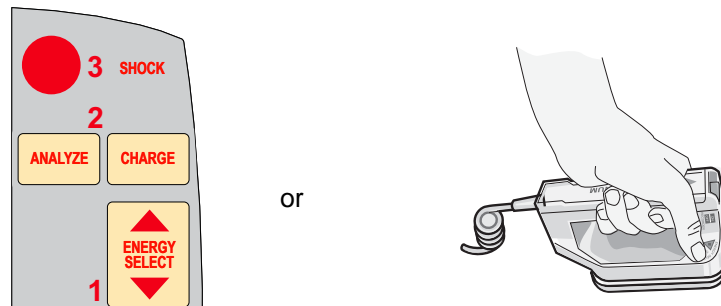
**Note:** Defibrillator PADDLES are selected as the ECG source when the instrument is turned to **MONITOR** or **DEFIB** with paddles connected to the OneStep cable.

### Energy Select

Look at the Display and verify the energy is appropriate. Unless internal handles are connected to the OneStep cable, the default energy selections for adult patients are:

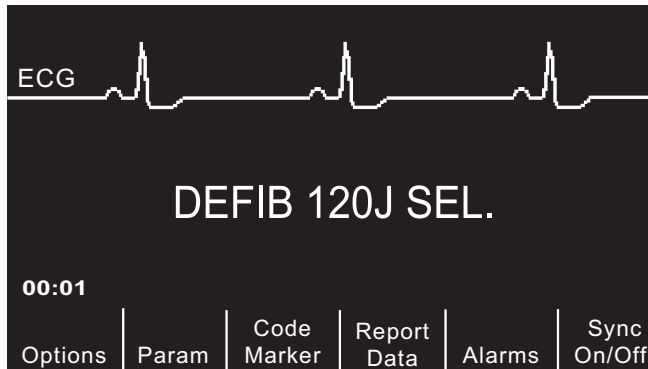
- Shock 1 - 120 joules
- Shock 2 - 150 joules
- Shock 3 - 200 joules

If medical protocol allows, you may select a different energy level using the up and down arrow buttons. One pair is located on the front panel of the unit; the other pair is located on the sternum paddle.



**Note:** Neonatal and pediatric defibrillator energy levels should be selected based on site-specific protocols.

The selected energy level is shown as *DEFIB XXXJ SEL.* on the display.



If you have configured Shocks 1, 2, and 3 to escalating energy levels (see the *R Series Configuration Guide* for instructions), the R Series automatically sets the energy to the preconfigured Energy Level: Shock 1, 2, 3 setting at power-up and after each of the first two shocks. The *ENERGY INCREMENTED* message will be displayed after Shocks 1 and 2 are delivered. Manually changing the energy level outside the preprogrammed sequence and delivering a shock disables the automatic escalation function.

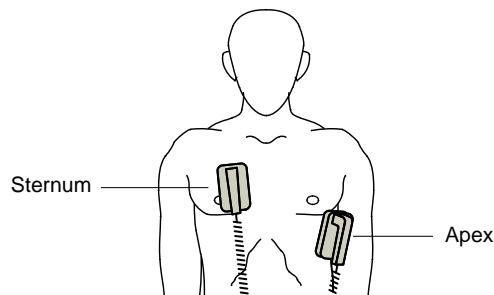
### Prepare Paddles

Release the paddles, apply a liberal amount of electrolyte gel to the electrode surface of each paddle, and rub the electrode surfaces together to evenly distribute the applied gel. (You can substitute electrode gel patches for the gel.)

### Apply Paddles to Chest

Apply the paddles firmly to the anterior wall of the chest. Place the sternum paddle to the right of the patient's sternum (patient's right), just below the clavicle.

Place the apex paddle on the chest wall, just below and to the left of the patient's left nipple, along the anterior-axillary line.



Rub the paddles against the skin to maximize the paddle-to-patient contact.

**WARNING!** Do not permit gel to accumulate between the paddle electrodes on the chest wall (gel bridge). This could cause burns and reduce the amount of energy delivered to the heart.

If using defibrillator gel pads, make sure that the size of the pad is large enough to cover the entire paddle electrode area.

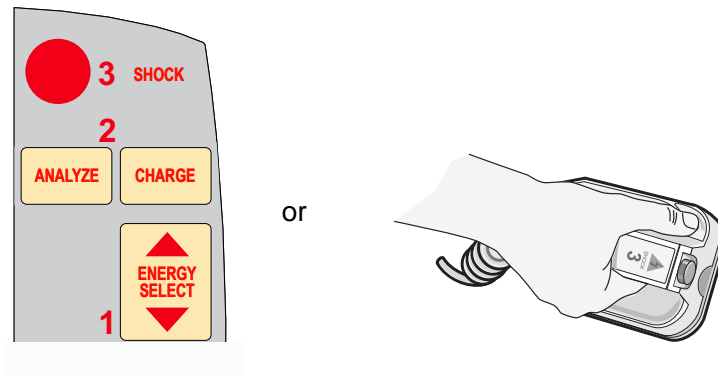
---

The paddles may be used for ECG monitoring in emergency situations when time does not allow connection of standard ECG monitoring electrodes.

If an ECG cable and ECG electrodes are in use, press the **LEAD** button to select the desired ECG lead.

## 2 Charge Defibrillator

Press the **CHARGE** button on the apex handle or on the front panel.



If both **SHOCK** buttons on the paddles are depressed when the **CHARGE** button is activated, the unit does not charge and a *RELEASE SHOCK BUTTON* message appears on the display.

To increase or decrease the selected energy after you have pressed the **CHARGE** button, use the defibrillator **ENERGY SELECT** buttons on either the sternum paddle or the defibrillator front panel.

---

**Caution** Changing the selected energy while the unit is charging or charged causes the defibrillator to disarm itself. Press the **CHARGE** button again to charge the unit to the newly selected energy level.

---

After charging to the selected energy, the charge indicator on the apex paddle lights. A distinctive charge ready tone sounds, and the message *DEFIB XXXJ READY* is displayed. The defibrillator is now ready to discharge.

### 3 Deliver Shock

---

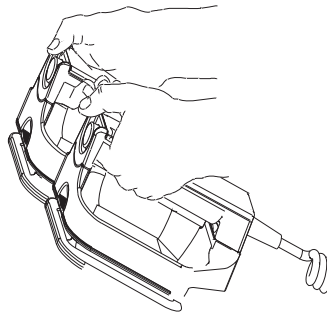
**WARNING!** Warn all persons in attendance of the patient to **STAND CLEAR** prior to defibrillator discharge.

**Do not touch the bed, patient, or any equipment connected to the patient during defibrillation. A severe shock can result. Do not allow exposed portions of the patient's body to come into contact with metal objects, such as a bed frame, as unwanted pathways for defibrillation current may result.**

---

Apply a force of 10 - 12 kilograms (22 - 26.4 pounds) to each paddle in order to minimize patient impedance and achieve optimal results.

Using your thumbs, simultaneously press and hold both **SHOCK** buttons (one on each paddle) until energy is delivered to the patient.



---

**Caution** Use only thumbs to depress the **SHOCK** buttons. Failure to do so could result in the inadvertent depression of the **ENERGY SELECT** buttons, causing the defibrillator to disarm itself.

---

Once the energy is delivered, the display simultaneously shows *XXXJ DELIVERED* and *DEFIB XXXJ SEL*. After approximately 5 seconds, the *XXXJ DELIVERED* message disappears, and the *DEFIB XXXJ SEL* message remains to indicate the selected energy level.

**Note:** If the defibrillator is not discharged within 60 seconds after reaching the selected energy level, the unit automatically disarms itself.

During the 10 seconds prior to disarming, the charge ready tone beeps intermittently. The charge ready tone then stops, the charge indicator light goes off, and the monitor message changes to *DEFIB XXXJ SEL*. Press the **CHARGE** button to recharge the unit.

## Autoclavable External Paddles

ZOLL Autoclavable External Paddles are available for use with manually operated ZOLL defibrillators when sterile conditions must be maintained during defibrillation.

# Emergency Defibrillation Procedure with Hands-Free Therapy Electrodes



ZOLL hands-free therapy electrodes are a defibrillation-protected Type BF patient connection.



ECG leads are a defibrillation-protected Type CF patient connection.

## Determine the Patient's Condition Following Local Medical Protocols

Verify:

- Unconsciousness.
- Absence of breathing.
- Absence of pulse.

## Begin CPR Following Medical Protocols

Request additional assistance.

## Prepare Patient

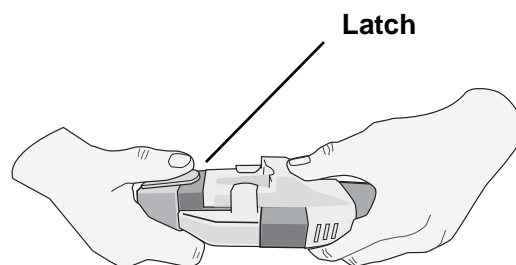
Remove all clothing covering the patient's chest. Dry chest if necessary. If the patient has excessive chest hair, clip or shave it to ensure proper adhesion of the electrodes.

Attach hands-free therapy electrodes according to instructions on the electrode packaging.

Ensure that the therapy electrodes are making good contact with the patient's skin and are not covering any part of the ECG electrodes.

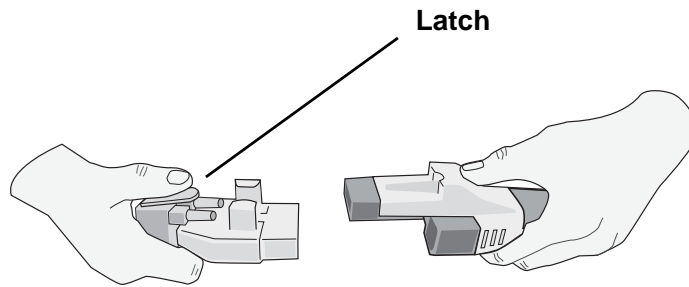
Connect the hands-free therapy electrodes to the OneStep cable if not preconnected.

When connecting a OneStep electrode to the OneStep cable, push the two connectors together until the latch clicks, as shown.





When disconnecting the OneStep electrode and OneStep cable, press down the latch with your thumb as shown.



If defibrillation electrodes are not making good contact with the patient's skin, the unit issues the messages *CHECK PADS* and *POOR PAD CONTACT* and does not allow delivery of energy. If a short circuit exists between the electrodes, the unit issues the message *DEFIB PAD SHORT*.

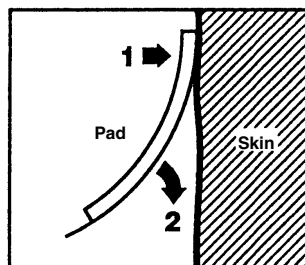
### Therapy Electrode Application

---

**WARNING!** Poor adherence and/or air under the therapy electrodes can lead to the possibility of arcing and skin burns.

---

1. Apply one edge of the pad securely to the patient.
2. Roll the pad smoothly from the applied edge to the other, being careful not to trap any air pockets between the gel and skin.



**Note:** If it is not possible to place the "BACK" electrode on the patient's back, place the electrodes in the standard apex-sternum positions. Effective defibrillation results, but pacing will usually be less effective.

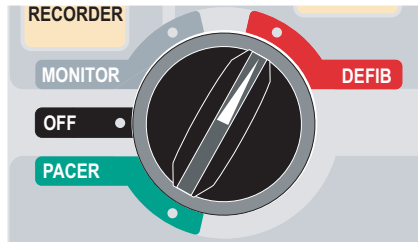
---

**WARNING!** Application of adult electrodes to a pediatric patient will result in the automatic selection of adult energy levels. If needed, manually adjust the energy settings based on site-specific protocols.

---

## 1 Select DEFIB

Turn the Mode Selector to DEFIB. The unit automatically defaults to 120 joules or the preconfigured first shock energy selection.



PADS are selected as the ECG source when the instrument is turned to MONITOR or DEFIB and paddles are not connected to the OneStep cable. You may select any of the other ECG leads by pressing the front panel **LEAD** button.

### Energy Select

Look at the display, and verify the selected energy is appropriate. The default energy selections for adult patients are:

- Shock 1 - 120 joules
- Shock 2 - 150 joules
- Shock 3 - 200 joules

When used with OneStep Pediatric electrodes, the default energy selections are:

- Shock 1 - 50 joules
- Shock 2 - 70 joules
- Shock 3 - 85 joules

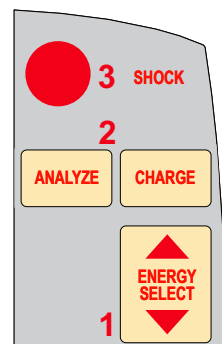
---

**WARNING!** When used with other pediatric defibrillation electrodes, defibrillator energies must be set manually based on site-specific institutional protocols for pediatric defibrillation.

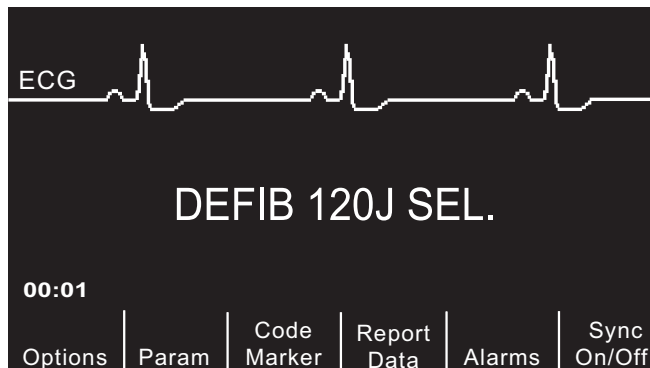
---

After the third shock, all subsequent shocks are delivered at the same energy as the third shock in both Adult and Pediatric modes.

If medical protocol allows, you may select a different energy level using the **ENERGY SELECT** buttons on the front panel.



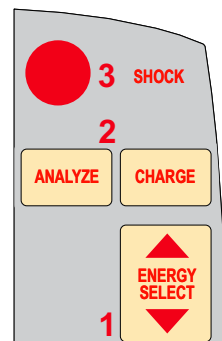
The selected energy level is shown as *DEFIB XXXJ SEL.* on the display.



If you have configured Shocks 1, 2, and 3 to escalating energy levels (see the *R Series Configuration Guide* for instructions), the R Series automatically sets the energy to the preconfigured Energy Level: Shock 1, 2, 3 setting at power-up and after each of the first two shocks. The *ENERGY INCREMENTED* message will be displayed after Shocks 1 and 2 are delivered. Manually changing the energy level outside the preprogrammed sequence and delivering a shock disables this function.

## 2 Charge Defibrillator

Press the **CHARGE** button on the front panel.



To increase or decrease the selected energy after you have pressed the **CHARGE** button, use the defibrillator **ENERGY SELECT** buttons.

---

**Caution** Changing the selected energy while the unit is charging or charged causes the defibrillator to disarm itself. Press the **CHARGE** button again to charge the unit.

---

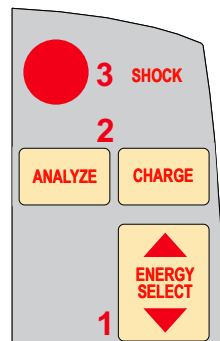
After charging to the selected energy, the **SHOCK** button on the front panel lights. A distinctive charge ready tone sounds and the *DEFIB XXXJ READY* is displayed. The defibrillator is now ready to discharge.

## 3 Deliver Shock

**WARNING!** Warn all persons in attendance of the patient to **STAND CLEAR** prior to defibrillator discharge.

**Do not touch the bed, patient, or any equipment connected to the patient during defibrillation. A severe shock can result. Do not allow exposed portions of the patient's body to come into contact with metal objects, such as a bed frame, as unwanted pathways for defibrillation current may result.**

Press and hold the **SHOCK** button until energy is delivered to the patient.



**Note:** If the defibrillator is not discharged within 60 seconds after reaching the selected energy level, the unit automatically disarms itself.

During the 10 seconds prior to disarming, the charge ready tone beeps intermittently. The charge ready tone then stops, the **SHOCK** button light goes off, and the monitor message changes to *DEFIB XXXJ SEL*. Press the **CHARGE** button to recharge the unit.

Once the energy is delivered, the display simultaneously shows *XXXJ DELIVERED* and *DEFIB XXXJ SEL*. After approximately 5 seconds, the *XXXJ DELIVERED* message disappears and the *DEFIB XXXJ SEL* message remains to indicate the selected energy level.

## Autoclavable Electrodes

ZOLL Autoclavable Internal Handles are designed for use with a manually operated ZOLL defibrillator to defibrillate the heart during open chest procedures. Two types of Autoclavable Internal Handles are available:

- Molded Autoclavable Internal handles with integrated electrode spoons
- Autoclavable Internal Handles with removable internal defibrillation electrodes

When these internal handles are used, the R Series defibrillator can operate only in Manual mode even if the unit supports Advisory mode. When an internal handle set is connected to the R Series, it automatically limits energy output to a maximum of 50 joules.

For step-by-step procedures for open chest defibrillation as well as important cleaning and sterilization information, refer to the *Autoclavable Internal Handle and Electrode Operator's Guide*.

# Chapter 4

## Advisory Defibrillation

---



ZOLL hands-free therapy electrodes are a defibrillation-protected Type BF patient connection.

When the Mode Selector is turned to DEFIB and hands-free therapy electrodes are used, the R Series can identify shockable rhythms using its built in ECG analysis capability. You must read the advisory messages, charge the defibrillator to the preconfigured or user-selected energy level (if automatic charge is disabled), and deliver treatment to the patient when required by protocol and patient condition.

The advisory function can be activated only when:

- Hands-free therapy electrodes are connected and selected as the ECG source.
- Hands-free therapy electrodes are properly connected to the patient.
- The Mode Selector is turned to **DEFIB**.

---

**WARNING!** Use only pediatric electrodes to defibrillate patients under 8 years of age in Advisory mode. Use of adult electrodes with pediatric patients can result in the delivery of excessive energy doses.

---

# Advisory Defibrillation Procedure

## Determine the Patient’s Condition Following Local Medical Protocols

Verify:

- Unconsciousness.
- Absence of breathing.
- Absence of pulse.

## Begin CPR Following Local Medical Protocols

Request additional assistance.

## Prepare Patient

Remove all clothing covering the patient’s chest. Dry chest if necessary. If the patient has excessive chest hair, clip or shave it to ensure proper adhesion of the electrodes.

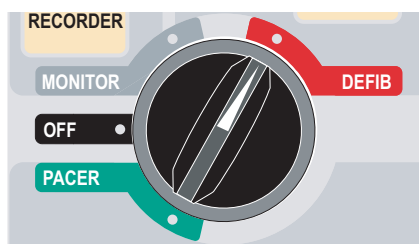
Attach hands-free therapy electrodes according to instructions on the electrode packaging and as described in “Therapy Electrode Application” on page 3-7.

Ensure that the electrodes are making good contact with the patient’s skin and are not covering any part of the ECG electrodes.

If therapy electrodes are not making good contact with the patient’s skin, the unit issues the messages *CHECK PADS* and *POOR PAD CONTACT* and does not allow delivery of energy. If a short circuit exists between the electrodes, the unit issues the message *DEFIB PAD SHORT*.

## 1 Select DEFIB

Turn the Mode Selector to **DEFIB**. The unit displays *DEFIB 120J SEL* on the monitor.



### Energy Select

The default energy selections for adult patients are:

- Shock 1 - 120 joules
- Shock 2 - 150 joules
- Shock 3 - 200 joules

When used with OneStep Pediatric electrodes, the default energy selections for pediatric patients are:

- Shock 1 - 50 joules
- Shock 2 - 70 joules
- Shock 3 - 85 joules

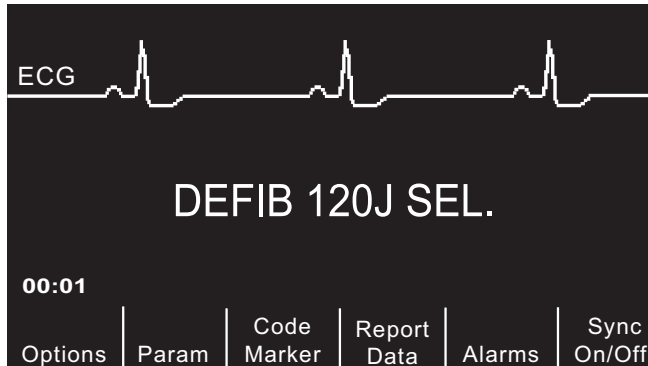
---

**WARNING! Use only OneStep Pediatric electrodes to defibrillate patients under 8 years of age in Advisory mode. Use of adult electrodes, or pediatric electrodes other than OneStep Pediatric electrodes, can result in the delivery of excessive energy doses.**

---

After the third shock, all subsequent shocks are delivered at the same energy as the third shock in both Adult and Pediatric modes.

If medical protocols allow, you may select a different energy level using the energy select up and down arrow buttons on the front panel. The new energy setting displays on the monitor.



If you have configured SHOCK 1, 2, and 3 to escalating energy levels, and then you manually change the energy level outside preconfigured SHOCK 1, 2, 3 sequence and deliver a shock, it disables the automatic energy escalation. See the Energy Level: Shock 1, 2, 3 section of the *R Series Configuration Guide* for more details.

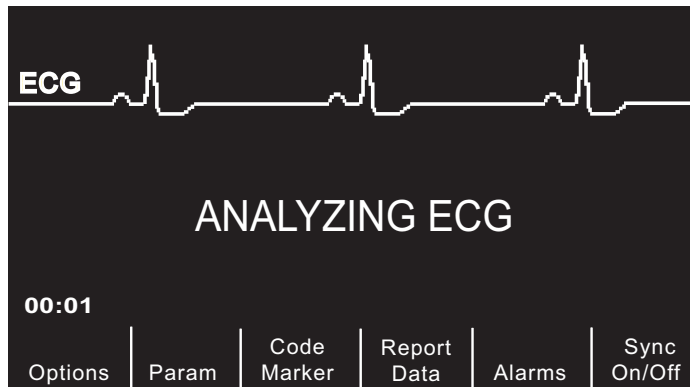
## 2 Press ANALYZE Button

---

**WARNING! Keep patient motionless during ECG analysis. Do not touch the patient during analysis. Cease all movement via stretcher before analyzing the ECG.**

---

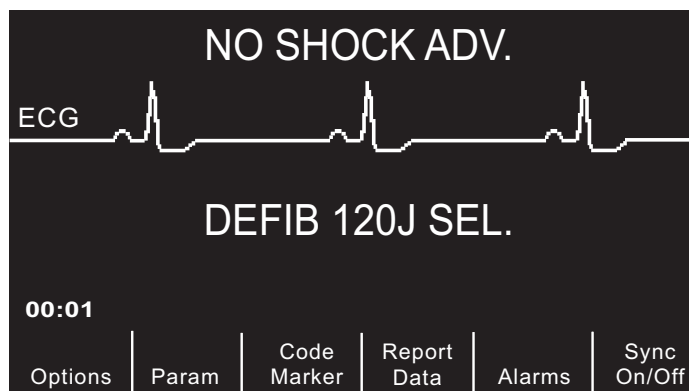
Press the **ANALYZE** button to begin the analysis of the patient’s ECG rhythm and to determine if a shockable rhythm is present.



An *ANALYZING ECG* message is displayed for 6 to 12 seconds while the patient’s ECG is analyzed. Once the analysis is completed, the unit indicates whether or not a shock is advised.

The analysis normally consists of three consecutive 3-second ECG rhythm analyses. If at least two of the three analyses determine that the patient has a shockable rhythm, the unit automatically charges to the preconfigured energy level and prompts the operator to shock the patient. If two or more of the three 3-second ECG analyses do not detect a shockable rhythm, the unit alerts the operator that no shock is advised.

**WARNING!** ECG rhythm analysis does not warn of patient asystole, which is not a shockable rhythm.



When a nonshockable rhythm is detected, the unit displays a *NO SHOCK ADV.* message. Follow the local protocols to continue CPR or other life support, and re-analyze the ECG at appropriate intervals.

**Note:** When a nonshockable rhythm is detected, the R Series does not prevent the user from manually defibrillating the patient.

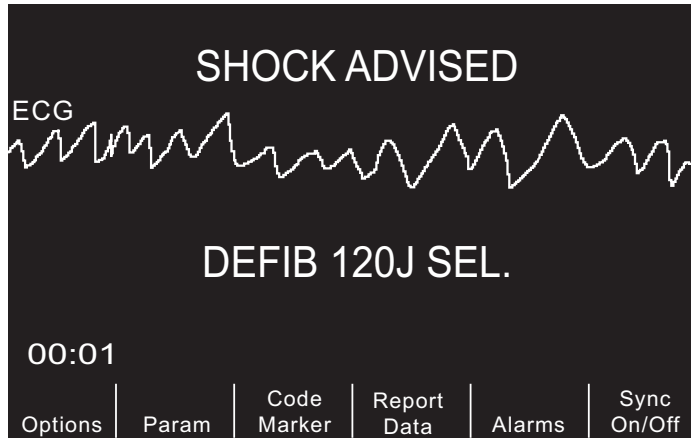
When a shockable rhythm is detected (ventricular fibrillation or wide-complex tachycardia with heart rate > 150), one of the following occur:

- Units with the automatic charge option enabled automatically charge to the preconfigured or user selected energy setting.



- Units with the automatic charge option disabled will alternately display the messages *SHOCK ADVISED* and *PRESS CHARGE*. Press the **CHARGE** button.

Regardless of the analysis result, the user can control the defibrillator manually. For example, the user can defibrillate the patient even if the advisory function issues a NO SHOCK ADV. message.



### 3 Press SHOCK

---

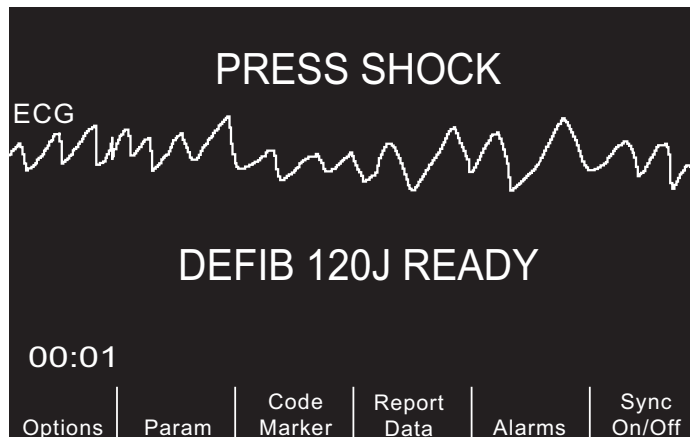
**WARNING!** Warn all persons in attendance of the patient to **STAND CLEAR** prior to defibrillator discharge.

**Do not touch the bed, patient, or any equipment connected to the patient during defibrillation. A severe shock can result. Do not allow exposed portions of the patient's body to come in contact with metal objects, such as a bed frame, as unwanted pathways for defibrillation current may result.**

---

Once the unit is charged to the selected energy, the **SHOCK** button illuminates and the *PRESS SHOCK* message is displayed. Simultaneously, the monitor displays the energy level to which the defibrillator is charged, *DEFIB XXXJ READY*.

**Note:** Rhythm analysis does not continue after the defibrillator is charged and ready once a decision to shock has been made. The R Series unit will not automatically disarm the defibrillator if the patient's rhythm reverts to a non-shockable rhythm before the shock has been delivered.



A continuous tone sounds for 50 seconds, followed by an intermittent beeping for 10 seconds. You must deliver the shock within this 60 second interval, or the defibrillator will disarm itself.

Press and hold the illuminated **SHOCK** button on the front panel until energy is delivered to the patient. An *XXXJ DELIVERED* message appears on the display for approximately 5 seconds.

Watch the patient or ECG response to verify that the shock has been delivered.

After the energy has been delivered to the patient, the display returns to *DEFIB XXX J SEL*.

### Perform CPR

Begin chest compressions and rescue breathing per local protocol.

### Repeat Analysis

Press the **ANALYZE** button to restart an ECG analysis and determine if additional shocks are required.

**Note:** Reanalysis of the ECG rhythm is inhibited for 3 seconds after each shock.

### Continue Patient Care

Continue patient care according to medical protocols.

---

## Advisory Function Messages

### **SELECT DEFIB MODE**

Displayed if the **ANALYZE** button is pressed, but the unit is not in the **DEFIB** mode. Turn the Mode Selector to **DEFIB** to enable the defibrillator and advisory capability.

### **SELECT PADS**

Displayed if the **ANALYZE** button is pressed while the device is operating in any ECG lead other than “PADS.” Press the **LEAD** button until “PADS” is selected.

### **REMOVE SYNC**

Displayed if the **ANALYZE** button is pressed while the device is in Sync mode. Turn off Sync mode by pressing the **Sync On/Off** softkey. Press the **ANALYZE** button again to initiate ECG rhythm analysis.

## Warning Messages

Warning messages prompt the operator to check the patient, the unit, the electrodes and/or connections.

### **NOISY ECG / RETRY ANALYSIS**

A *NOISY ECG* message alternating with a *RETRY ANALYSIS* message is displayed for 5 seconds when the unit detects a noisy ECG signal during ECG analysis. Check and adjust electrode placement and cable connections to help eliminate the noise source. Keep patient motionless during ECG analysis. Press the **ANALYZE** button again to begin ECG analysis.

### **CHECK PATIENT**

The unit has detected a shockable rhythm during continuous background ECG analysis (i.e., Smart Alarms™). The prompt is given only when the heart rate alarms are enabled and the unit detects a shockable rhythm. The screen message persists as long as a shockable rhythm is being detected. Press the **ANALYZE** button to begin ECG analysis.

**Note:** This CHECK PATIENT analysis function operates continuously when heart rate alarms are enabled and does not require pressing the **ANALYZE** button for operation.

### **CHECK PADS / POOR PAD CONTACT**

The therapy electrodes are not properly attached to the patient, or the cable connections have become loose.

Check that the therapy electrodes are making good contact with the patient’s skin and that all cables are securely connected. This voice prompt will not sound if the therapy electrodes were not previously connected to the patient.

(This page intentionally left blank.)

# Chapter 5

## Synchronized Cardioversion

---



Paddles are a defibrillation-protected Type BF patient connection.



ECG leads are a defibrillation-protected Type CF patient connection.

---

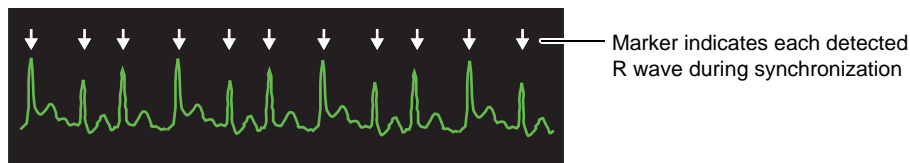
**WARNING!** Only skilled personnel trained in Advanced Cardiac Life Support and familiar with equipment operation should perform synchronized cardioversion. The precise cardiac arrhythmia must be determined before attempting defibrillation or cardioversion.

**Before attempting synchronized cardioversion, ensure that ECG signal quality is sufficient to minimize the risk of synchronizing on artifact.**

---

Certain arrhythmias, such as ventricular tachycardia, atrial fibrillation, and atrial flutter, require synchronizing the defibrillator discharge with the ECG R-wave to avoid the induction of ventricular fibrillation. In this case, a synchronizing (Sync) circuit within the defibrillator detects the patient's R-waves. When the **SHOCK** button (or buttons, if using paddles) is pressed and held, the unit discharges with the next detected R-wave, thus avoiding the vulnerable T-wave segment of the cardiac cycle.

When in the Sync mode, the unit displays markers (↓) above the ECG trace to indicate the points in the cardiac cycle (R waves) where discharge can occur.



Verify that markers are clearly visible on the monitor and their location is appropriate and consistent from beat to beat. If necessary, use the **LEAD** and **SIZE** buttons to establish settings that yield the most consistent Sync marker pattern.

The **Sync On/Off** softkey may be highlighted for clearer visibility, if desired. This is off by default. Refer to the *R Series Configuration Guide* for instructions on how to turn on the highlighting.



The synchronized cardioversion procedure for ZOLL hands-free therapy electrodes is identical to that for paddles with the exception of the **SHOCK** button location.

The R Series defibrillator supports two types of synchronized cardioversion:

- **Synchronized Cardioversion** — The R Series monitors the patient’s ECG and synchronizes shock delivery with this ECG source. For instructions, refer to “Synchronized Cardioversion Procedure” below.
- **Remote Synchronized Cardioversion** — An external device (such as a patient monitor) monitors the patient’s ECG and provides a synchronization pulse to the R Series’ Sync In/Marker Out connector. The R Series synchronizes shock delivery with these external pulses.

**Note:** When using the Remote Sync function, the procedure and displayed information are different. Make sure to follow the instructions for Remote Synchronized Cardioversion on page 5-5.

## Synchronized Cardioversion Procedure

### Determine the Patient’s Condition and Provide Care Following Local Medical Protocols

#### Prepare Patient

Remove all clothing covering the patient’s chest. Dry chest if necessary. If the patient has excessive chest hair, clip or shave it to ensure proper adhesion of the electrodes.

Attach ECG electrodes as described in “Monitoring Electrodes Attachment” on page 9-3.

A standard ECG cable and ECG electrodes are recommended for use during cardioversion. Hands-free therapy electrodes may be used as an ECG source. Signal quality will be equal to that of standard leads except immediately following a discharge when there may be more noise due to muscle tremors, especially if an electrode is not in complete contact with the skin.

Attach hands-free therapy electrodes according to instructions on the electrode packaging and as described in “Therapy Electrode Application” on page 3-7.

Ensure that the therapy electrodes are making good contact with the patient’s skin and are not covering any part of any other electrodes.

Connect the hands-free therapy electrodes to the OneStep cable if not preconnected.

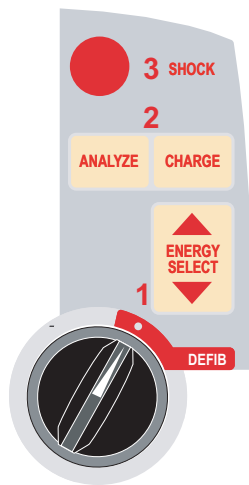
If therapy electrodes are not making good contact with the patient’s skin, the unit issues the messages *CHECK PADS* and *POOR PAD CONTACT* and does not allow delivery of energy. If a short circuit exists between the electrodes, the unit issues the message *DEFIB PAD SHORT*.

An *ECG LEAD OFF* condition prevents synchronized discharge if leads are selected as the ECG source. This condition does not prevent the use of the defibrillator; it simply prevents use in a synchronized manner.

If paddles are being used for synchronized cardioversion, refer to “Emergency Defibrillation Procedure with Paddles” on page 3-1 for preparing paddles, applying paddles, charging the defibrillator, and delivering a shock. Note, however, that synchronized discharge with paddles as an ECG source is discouraged since the artifact induced by moving the paddles may resemble an R-wave and trigger defibrillator discharge at the wrong time.

## 1 Select DEFIB

Turn the Mode Selector to **DEFIB**. Select the desired energy using the up and down arrow keys on the front panel (or sternum paddle if using paddles).



### Press the Sync On/Off softkey

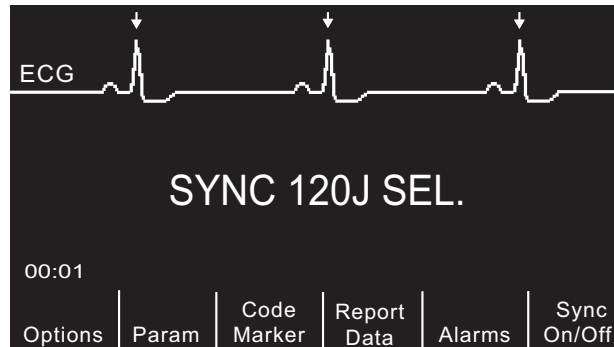
Your system will be in Sync mode once you press the **Sync On/Off** softkey if your R Series is not configured to support Remote Sync. However, if your R Series is configured to support Remote Sync, pressing the **Sync On/Off** softkey will cause two other softkeys to be displayed: **Remote Sync** and **Sync**. Press the **Sync** softkey to enter Sync mode.

The selected energy level is displayed on the monitor.

A Sync marker (↓) appears on the monitor above each detected R-wave to indicate where discharge will occur.

Verify that the markers are clearly visible on the monitor and their location is appropriate and consistent from beat to beat. If necessary, use the **LEAD** and **SIZE** buttons to establish settings that yield the best display.

A *SYNC XXXJ SEL.* message appears on the display. If *DEFIB XXXJ SEL.* appears, press the **Sync On/Off** softkey. (If your unit supports Remote Sync, you must also press the **Sync** softkey.) Two quick beeps sound.



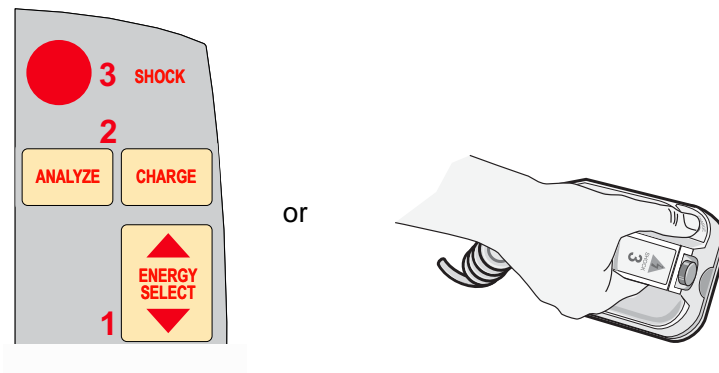
Unless otherwise configured, the unit automatically exits Sync mode after each shock and when the Mode Selector is moved to **MONITOR**, **PACER** or **OFF**.

To reactivate Sync mode, press the **Sync On/Off** softkey again. (If your unit supports Remote Sync, press the **Sync** softkey again.) Changing the selected energy levels does not cause the unit to leave Sync mode.

Note that the unit can be configured to stay in Sync mode after defibrillation, if desired. Refer to the *R Series Configuration Guide* for instructions.

## 2 Charge Defibrillator

Press the **CHARGE** button on the front panel or on the apex paddle handle.



To abort charging and increase or decrease the selected energy after the **CHARGE** button has been pressed, use the **ENERGY SELECT** buttons on either the defibrillator front panel or the sternum paddle. Press the **CHARGE** button again to charge the unit to the newly selected energy level.

After charging the unit to the selected energy, either the front panel **SHOCK** button or the APEX paddle charge indicator illuminates. A distinctive audible tone sounds and the *SYNC XXXJ READY* message is displayed.

The defibrillator is now ready to deliver therapy.



### 3 Deliver SHOCK

---

**WARNING!** Warn all persons in attendance of the patient to **STAND CLEAR** prior to defibrillator discharge.

**Verify that no one is in contact with the patient, monitoring cable or leads, bed rails, or any other potential current pathways.**

---

Verify that the ECG waveform is stable and that Sync markers appear over each R-wave.

Press and hold the illuminated **SHOCK** button on the front panel, (or simultaneously press and hold both paddle **SHOCK** buttons) until energy is delivered to the patient. The defibrillator will discharge with the next detected R wave.

**Note:** If the defibrillator is not discharged within 60 seconds after reaching the selected energy level, the unit automatically disarms itself. During the ten seconds prior to this internal disarm, the charge ready tone beeps intermittently. The charge ready tone then stops, and the defibrillator remains in Sync mode.

Once the energy is delivered, the display simultaneously shows *XXXJ DELIVERED* and *DEFIB XXXJ SEL*. After approximately 5 seconds, the *XXXJ DELIVERED* message disappears and the *DEFIB XXXJ SEL* message remains to indicate the selected energy level.

If additional countershocks are necessary, readjust the energy level as necessary, press the **Sync On/Off** softkey, followed by the **Sync** softkey (if your unit supports Remote Sync), and repeat. Note that *SYNC XXXJ SEL* must be displayed prior to pressing the **CHARGE** button.

If the **ANALYZE** button is pressed while the unit is in Sync mode, the unit displays the *REMOVE SYNC* message and does not allow ECG rhythm analysis until the unit is taken out of Sync mode.

## Remote Synchronized Cardioversion Procedure

The R Series may be configured to receive defibrillation synchronization pulses from a remote ECG monitoring device. See the *R Series Configuration Manual*. Be sure that the remote device is connected to the Sync In/Marker Out connector on the R Series unit. The remote device must have a Sync out connector and a cable must be provided to connect the two devices. Ensure the remote device conforms with the Sync In/Marker Out specifications (described in Appendix A, “Defibrillator Specifications”).

---

**WARNING!** A lethal arrhythmia may be induced through improper synchronization. Qualified personnel within the hospital should verify synchronization delay for the entire remote monitor and defibrillator system prior to clinical use. Synchronization delay for the system as a whole must not exceed 60 msec.

---

## Determine the Patient's Condition and Provide Care Following Local Medical Protocols

### Prepare Patient

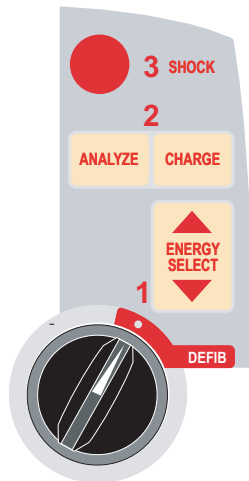
Prepare the patient as described in “Prepare Patient” on page 5-2.

Follow the instructions provided with the external monitoring device to prepare the patient for ECG monitoring and synchronization with a separate defibrillator.

### 1 Select DEFIB

Turn the Mode Selector to **DEFIB**.

Select the desired energy using the up and down arrow keys on the front panel (or sternum paddle if using paddles).



#### Press Sync On/Off softkey, then press the Remote Sync Softkey

The selected energy level is displayed on the monitor.

The words “REMOTE SYNC” are displayed in place of the ECG trace, and a *REMOTE SYNC XXXJ SEL* message appears on the display.

The ECG heartbeat indicator will flash with each synchronization pulse received from the remote monitoring device.

Unless otherwise configured, the unit automatically exits Sync mode after each shock, and if the Mode Selector is moved to **MONITOR, PACER** or **OFF**.

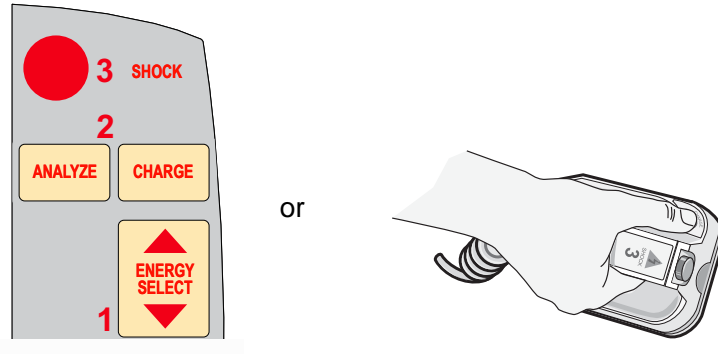
Press the **Sync On/Off, Remote Sync** softkey sequence again to reactivate Remote Sync mode. Changing the selected energy levels does not cause the unit to leave Remote Sync mode.

View the ECG trace on the remote device's display. Verify that Sync markers appear with each R-wave. The Sync markers will appear as described in the remote device's user manual.

**WARNING!** Verify the ECG waveform is stable and that a Sync marker appears only with R-waves. If Sync markers are not present on the remote device display, or do not appear to be nearly simultaneous with each R-wave, do not proceed with synchronized cardioversion.

## 2 Charge Defibrillator

Press the **CHARGE** button on the front panel or, if using paddles, on the apex paddle handle.



To abort charging and increase or decrease the selected energy after the **CHARGE** button has been pressed, use the **ENERGY SELECT** buttons on either the defibrillator front panel or the sternum paddle. Press the **CHARGE** button again to charge the unit.

After charging the unit to the selected energy, either the front panel **SHOCK** button or, the apex paddle charge indicator illuminates. A distinctive audible tone sounds and the energy ready *REMOTE SYNC XXXJ READY* message is displayed.

The defibrillator is now ready to deliver therapy.

## 3 Deliver SHOCK

**WARNING!** Warn all persons in attendance of the patient to **STAND CLEAR** prior to defibrillator discharge.

**Verify that no one is in contact with the patient, monitoring cable or leads, bed rails, or any other potential current pathways.**

Press and hold the illuminated **SHOCK** button on the front panel, or simultaneously press and hold both paddle **SHOCK** buttons until energy is delivered. The defibrillator will discharge with the next remote synchronization pulse.

**Note:** If the defibrillator is not discharged within 60 seconds after reaching the selected energy level, the unit automatically disarms itself. During the ten seconds prior to this internal disarm, the charge ready tone beeps intermittently. The charge ready tone then stops and the defibrillator remains in Remote Sync mode.

Once the energy is delivered, the display simultaneously shows *XXXJ DELIVERED* and *DEFIB XXXJ SEL*. After approximately 5 seconds, the *XXXJ DELIVERED* message disappears and the *DEFIB XXXJ SEL* message remains to indicate the selected energy level.

If additional countershocks are necessary, readjust the energy level as necessary, press the **Sync On/Off**, and then the **Remote Sync** softkeys and repeat. Note that *REMOTE SYNC XXXJ SEL* must be displayed prior to pressing the **CHARGE** button.

If the **ANALYZE** button is pressed while the unit is in Remote Sync mode, the unit displays the *REMOVE SYNC* message and disallows ECG rhythm analysis until the unit is taken out of Sync mode.

# Chapter 6

## Real CPR Help

---



Real CPR Help is defibrillation-proof Type BF equipment.

---

**WARNING!** The Real CPR Help function is fully functional *only* when using adult CPR electrodes. Do *not* use Adult CPR electrodes with patients under 8 years of age.

---

---

**WARNING!** Use *only* Pediatric CPR electrodes with patients under 8 years of age. The use of Pediatric CPR electrodes enables the R Series unit to display Idle Time and Compression Rate and Depth measurements. Pediatric CPR electrodes do *not* enable Real CPR voice prompts or any visual indication of ineffective CPR.

---

When used with OneStep CPR electrodes or OneStep Complete electrodes, the R Series unit can provide rescuers with feedback about the quality of CPR they are delivering to their patients. The way in which feedback is provided varies with respect to the operational mode and user configuration, but is derived from compression rate and depth measurements.

When applied according to package instructions, ZOLL OneStep CPR and OneStep Complete electrodes provide a chest compression sensor that is located between the rescuer's hands and the patient's lower sternum. This sensor monitors the rate and depth of chest compressions and sends this information to the R Series unit for processing and display.

The R Series defibrillator uses this information to provide feedback to the rescuer in one or more of the following forms:

- Perfusion Performance Indicator

- CPR Idle Time Display
- CPR Rate Metronome
- Voice prompts
- Chest Compressions Waveform display
- *FULLY RELEASE* display prompt (if configured)

## Real CPR Help Field

Whenever OneStep CPR, or OneStep Complete electrodes are connected to the R Series defibrillator, the unit illuminates the Real CPR Help field in the upper center portion of the display. This field includes the indicators described in the next sections.

### Perfusion Performance Indicator (Optional/Adult Only)

This diamond shaped figure provides a quick, overall indicator of how well the rescuer's combined rate and depth of chest compressions match the AHA/ERC recommendations for adult CPR.

Before chest compressions begin (and after each shock), the Perfusion Performance Indicator is displayed as a hollow outline. This index starts to fill from the center out as compressions begin, and becomes fully filled when consistent chest compression depth exceeding 1.5 or 2 inches, depending on the configuration, and rate exceeding 100 compressions per minute (cpm) are simultaneously achieved. Should the chest compression rate or depth begin to fall below the AHA/ERC recommended levels, the PPI will only partially fill to indicate the need for more vigorous efforts. Following the cessation of compressions, the PPI's fill level gradually decreases until a hollow outline is displayed after a short period of time.

When complete filling of the Perfusion Performance Indicator has not been achieved due to diminished compression rate or depth, and the CPR Dashboard is configured Off, the R Series will display the words RATE and/or DEPTH to assist the rescuer in determining whether chest compression rate or depth should be increased. When an appropriate rate or depth has been achieved, 100 cpm and 1.5 or 2 inches, respectively, one or both of these words will disappear from the display.

This feature is unavailable while using Pediatric CPR electrodes.

### CPR Idle Time Display

This display indicates the elapsed time in minutes and seconds since the last detected chest compression. When compressions are being delivered, this time display will be blanked. Three seconds following the cessation of compressions, the display will illuminate and show the elapsed time since the last detected compression. If no compressions have been delivered for more than 20 minutes, dashes (---) will be displayed in this time field.

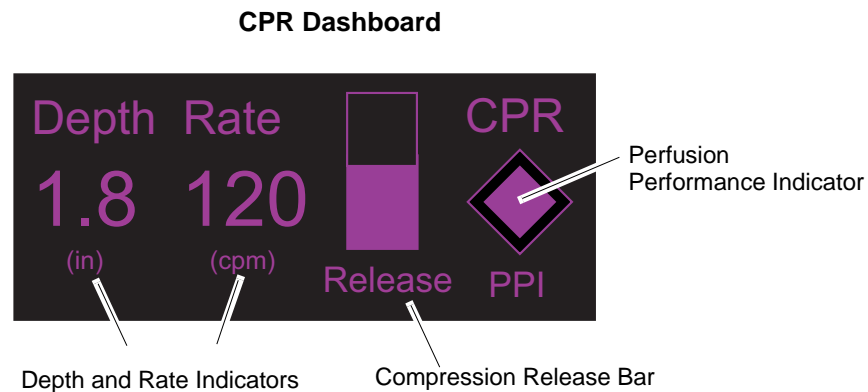
### CPR Rate and Depth Display

If the CPR Dashboard is configured On and the CPR Idle Time is not displayed, the Rate and Depth values are displayed in the default color; the same values are highlighted and change color if they are not within the AHA-recommended range of below 100 or over 120 compressions per minute. This feature is unavailable while using Pediatric CPR electrodes.

## Compression Release Bar (Adult only)

If the CPR Dashboard is configured On, the Compression Release Bar shows the release of the chest compression by the rescuer. When the release of the chest is properly administered (quickly and completely released), the bar will fill all the way to the top.

This feature is unavailable while using Pediatric CPR electrodes.



## CPR Metronome

The R Series unit includes a CPR metronome feature that can be used to encourage rescuers to perform chest compressions at the AHA/ERC recommended rate of 100 - 120 compressions per minute. This feature can be configured.

When activated, the metronome beeps at the AHA/ERC recommended rate to provide a compression rhythm for rescuers to follow. The metronome is silent when no chest compressions are being detected by CPR-equipped hands-free therapy electrodes.

When Manual and Advisory modes are configured to “Yes,” the metronome only beeps when chest compressions are detected and their rate falls below the AHA/ERC recommended levels. When compressions are being performed at 100 compressions per minute or higher, the metronome is silent. Should the detected compression rate fall below this level, the metronome will begin beeping until recommended compression rates are consistently achieved over several compression cycles. The metronome stops beeping approximately 2 seconds after the last chest compression is detected.

When Manual and Advisory modes are configured to “Continuous,” the metronome beeps as long as compressions are detected, even when they are being performed at 100 compressions per minute or higher. The metronome stops beeping approximately 2 seconds after the last chest compression is detected.

## Fully Release prompt

The R Series unit can be configured to display the text prompt FULLY RELEASE, which reminds rescuers to lift (fully release) their hands from the patient’s chest during compressions to allow full recoil.

By default, the FULLY RELEASE text prompt is not enabled.

This feature is unavailable while using Pediatric CPR electrodes.

## CPR Voice Prompts (Adult only)

The R Series unit can be configured to issue voice prompts related to the depth of chest compressions as feedback to rescuers performing CPR. Two voice prompts are available for this purpose:

- Push Harder
- Good Compressions

When chest compressions are detected but their depth is consistently less than 1.5 or 2 inches (3.8 or 5 cm), depending on the configuration, the defibrillator will issue the prompt “Push Harder” every 15 seconds. If the rescuer responds by increasing compression depth to more than 1.5 or 2 inches (3.8 or 5 cm), depending on the configuration, on a consistent basis, the unit will issue a “Good Compressions” prompt.

See the *R Series Configuration Guide* for information on enabling/disabling CPR voice prompts.

CPR Voice prompts are unavailable while using Pediatric CPR electrodes.

## Chest Compressions Bar Graph

The R Series unit can display a CPR compression bar graph computed from the CPR sensor signals. This bar graph, representing depth of compression, is presented on a displacement scale with a reference marker at 1.5 or 2.0 inches, depending on the configuration. When the full width of the trace is visible, the unit displays a minimum of 12 seconds of compression data.

## Displaying the CPR Bar Graph

To display the CPR displacement bar graph in the Trace 2 or 3 position:

1. Press the **Options** softkey, then press **Traces**.
2. Press either the **Trace 2** or **Trace 3** softkey.
3. Press **CPR**.

**Note:** The **CPR** softkey appears only when OneStep CPR or OneStep Complete electrodes are in use.



# Chapter 7

## See-Thru CPR (Optional)

---

**WARNING!** The See-Thru CPR filter works only when the R Series defibrillator is monitoring CPR.

The See-Thru CPR filter stops if:

- The unit is in pace mode.
- Patient impedance is invalid.
- OneStep CPR electrodes or OneStep Complete electrodes are no longer detected.

The See-Thru CPR filter will not remove all CPR artifact. Always stop CPR to verify the patient's ECG rhythm before making treatment decisions.

The See-Thru CPR filter does not operate during ECG rhythm analysis. Always stop chest compressions during ECG rhythm analysis to avoid incorrect results caused by the presence of CPR artifact.

**Diagnostic bandwidth is never applied to the See-Thru CPR waveform.**

---

See-Thru CPR enables the rescuer to see a close approximation of the patient's underlying ECG rhythm while performing CPR. See-Thru CPR is available if the R Series is monitoring CPR.

Chest compressions introduce *CPR artifact* into the ECG signal. See-Thru CPR uses a filter that relies on the correlation between CPR compressions, as detected by the ZOLL Onestep CPR or OneStep Complete electrodes, and the CPR artifact to remove much, but not all, of the artifact from the ECG signal. Under some conditions, residual noise after filtering can obscure the ECG rhythm, requiring the rescuer to stop CPR to assess the ECG. For example, in the case of asystole or low amplitude PEA, the residual artifact seen after filtering may look like fine ventricular fibrillation.

Because the filtered ECG signal may contain residual chest compression and/or filtering artifacts, *a rescuer should always follow the standard procedure of stopping CPR to assess the patient's ECG rhythm before determining treatment.*

## Using See-Thru CPR

To use See-Thru CPR

- The R Series unit must be monitoring CPR.
- OneStep CPR or OneStep Complete electrodes must be attached to the unit.

When chest compressions begin, the R Series unit *automatically* starts filtering the CPR artifact after detecting the first 3 to 6 compressions.

The filtered ECG, with the label “FIL,” may be displayed on the second or third trace (by selecting **FILT ECG** in the Trace2 or Trace3 menu). See-Thru CPR filtering continues as long as the OneStep CPR or OneStep Complete electrodes detect compressions and patient impedance is valid. When no compressions are detected or one of the conditions noted above occurs, See-Thru CPR filtering stops, and unfiltered ECG signals are displayed. When compressions resume, filtering automatically restarts after 3 to 6 chest compressions.

**Note:** There is a delay of approximately 1/16 second between the See-Thru CPR waveform and the Trace 1 ECG waveform.

If configured to display the CPR Dashboard, the R Series unit can also be configured to display the filtered ECG in Trace1. When the unit is configured to display the filtered ECG in Trace1, the softkey **Disable Filt ECG** appears, which you can press to disable display of the filtered ECG in Trace1 and replace it with the unfiltered ECG. When the unit displays the unfiltered ECG in Trace1, the softkey **Enable Filt ECG** appears, which can redisplay the filtered ECG in Trace1.

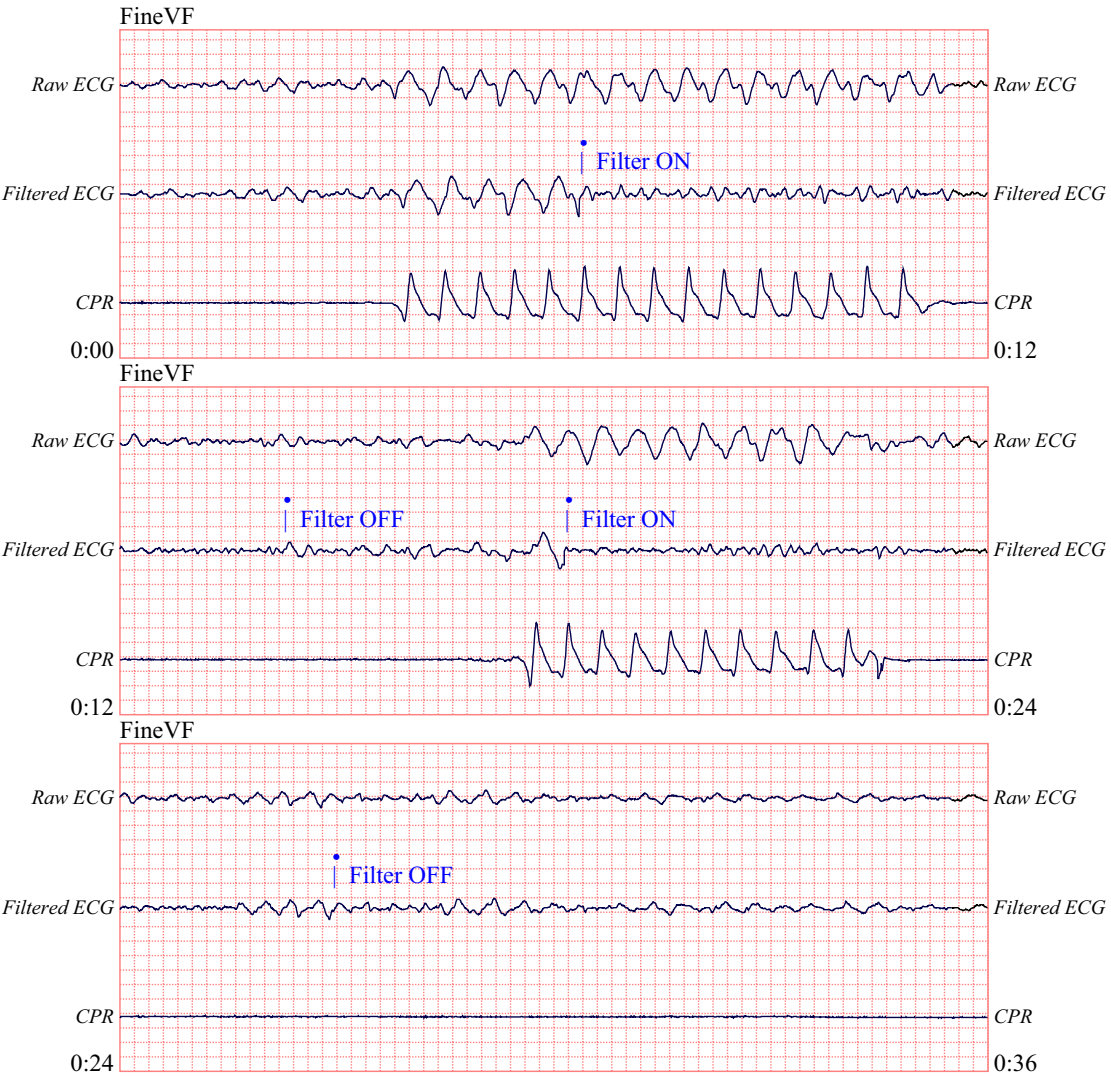
## Examples

The following examples show the effects of See-Thru CPR filtering on ECG signals contaminated with CPR artifacts.

Each example includes:

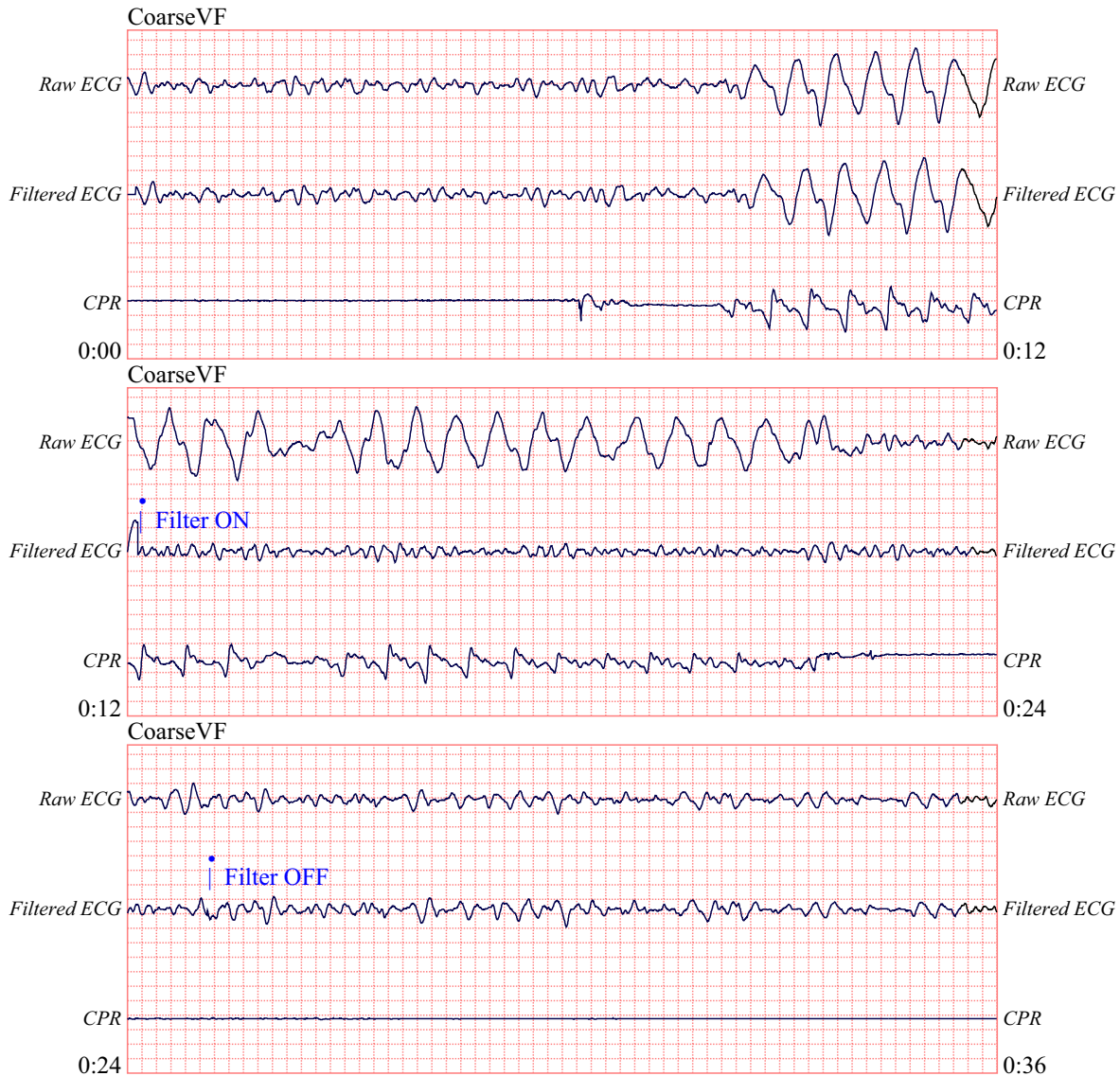
- ECG signal with CPR artifact.
- ECG signal after the See-Thru CPR filter has removed CPR artifact.
- Indication of the period during which See-Thru CPR is active.
- CPR signal to show when CPR activity occurred.

The following figure shows a patient in Fine VF. It is difficult for a rescuer to discern this rhythm during CPR compressions. When the CPR filter turns on, the Fine VF rhythm becomes more obvious.



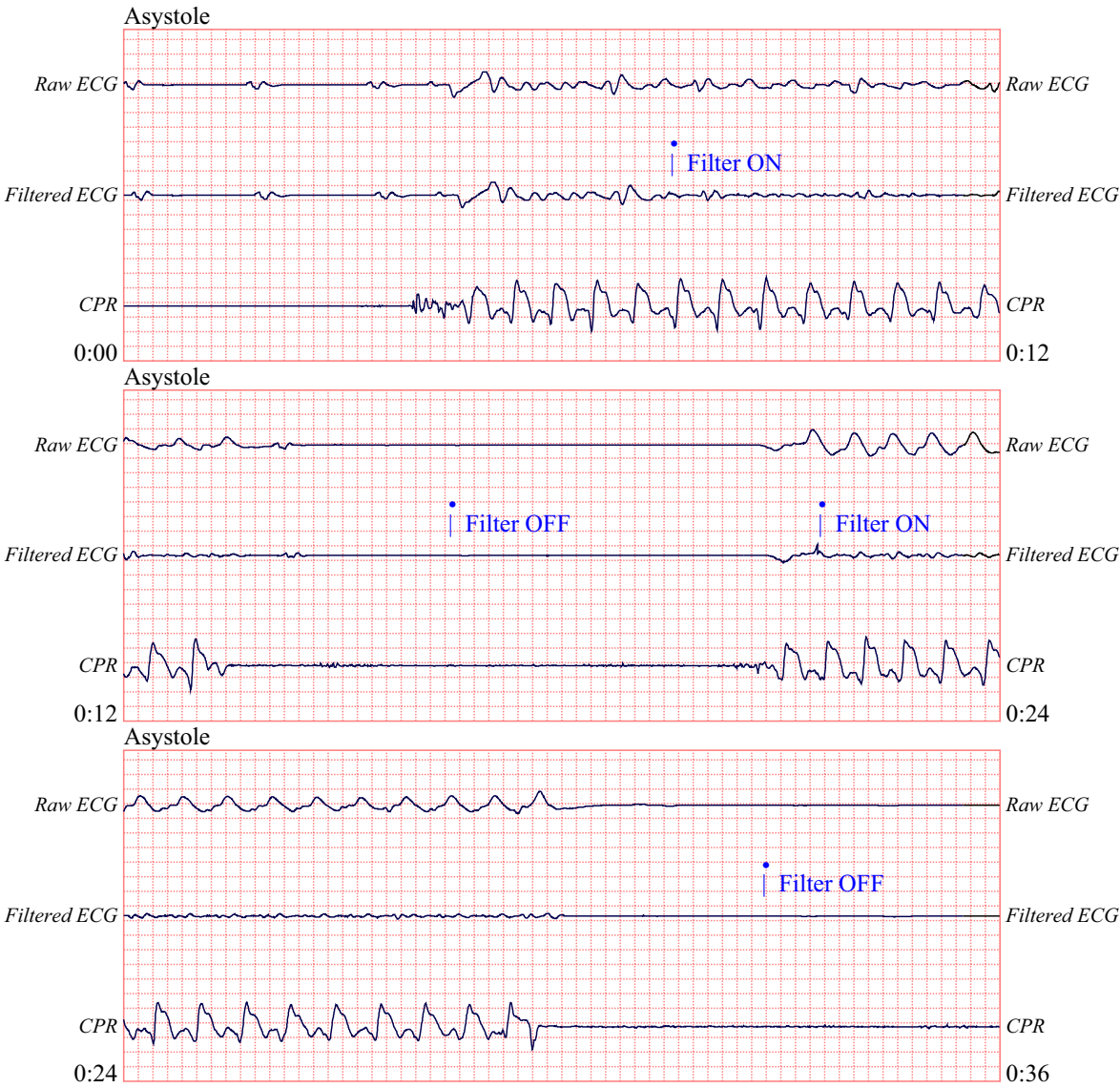
12.5 mm/sec, 5 mm/mV

The following figure shows a patient in VF, which, during compressions, is slightly more difficult to discern. When viewing this ECG, it is possible to view the underlying rhythm as the filter is able to reject all of the CPR artifact.



12.5 mm/sec, 5 mm/mV

The following figure shows a patient in PEA, which could easily be mistaken for Fine VF because enough of the compression artifact leaks through to distort this signal. When the CPR filter turns on, the PEA is still not obvious because of the left over ripples from the CPR signal. About 14 seconds into this chart, the rhythm changes to asystole, which could easily be mistaken for coarse VF. When the CPR filter turns on, the CPR compression ripples are still obvious, making the rhythm look like Fine VF.



12.5 mm/sec, 5 mm/mV

The following figure shows a patient with an organized rhythm where See-Thru CPR effectively filters out artifact created by CPR.



12.5 mm/sec, 5 mm/mV

# Chapter 8

## Noninvasive Temporary Pacing (Optional)

---



When ZOLL hands-free therapy electrodes are used, the patient connection is considered to be defibrillation-protected Type BF.



ECG leads are a defibrillation-protected Type CF patient connection.

---

**WARNING!** To avoid risk of electrical shock, do not touch the gelled area of the hands-free therapy electrodes while pacing.

Therapy electrodes should be replaced periodically. Consult electrode directions for specific recommendations.

Prolonged pacing (in excess of 30 minutes), particularly in neonates or adults with severely restricted blood flow, may cause burns. Periodic inspection of the underlying skin is recommended.

If the unit was NOT turned off and less than 10 minutes have elapsed since the pacing mode was last used, reactivating the pacer mode causes pacing to resume immediately at the previously selected mA and ppm settings.

---

## Noninvasive Temporary Pacing

R Series defibrillators with the pacer option contain a VVI demand pacemaker – a safe and effective design for Noninvasive Temporary Pacemakers.

Proper demand pacing requires a reliable, high quality surface ECG signal. For best results:

- Apply both standard ECG monitoring electrodes and hands-free pacing therapy electrodes (such as, OneStep electrodes or Stat-padz) to the patient,  
or
- Use OneStep Pacing electrodes, or OneStep Complete electrodes. These hands-free therapy pads include both ECG monitoring and pacing/defibrillation electrodes in a single pad assembly. They provide reliable ECG monitoring without the need to use separate ECG leads. With these electrodes you must also use the OneStep Pacing cable.

### Determine Patient Condition and Provide Care Following Local Medical Protocols.

#### Prepare the Patient

Remove all clothing covering the patient's chest. Dry chest if necessary. If the patient has excessive chest hair, clip it to ensure proper adhesion of the electrodes.

#### 1 Apply ECG Electrodes/Hands-Free Therapy Electrodes

The R Series supports two electrode configurations for pacing:

- **OneStep Pacing Configuration**

Simultaneous ECG monitoring and pacing can be performed with a single set of therapy electrodes when using OneStep Pacing electrodes or OneStep Complete electrodes along with a OneStep Pacing cable. The OneStep Pacing cable must be connected to both the MFC and ECG connectors of the R Series unit. Attach OneStep electrodes according to instructions on the electrode packaging. Then connect the electrodes to the OneStep Pacing cable.

- **Separate ECG Electrodes and Hands-free Therapy Electrodes Configuration**

Apply ECG electrodes, attach lead wires, and connect the ECG cable to the R Series rear panel (see page 9-3 for instructions on attaching ECG electrodes to the patient). Attach hands-free therapy electrodes according to instructions on the electrode packaging. Connect these therapy electrodes to the OneStep cable.

#### Therapy Electrode Application

---

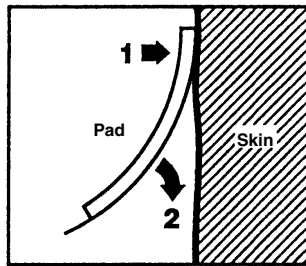
**WARNING!** Poor adherence and/or air under the therapy electrodes can lead to the possibility of arcing and skin burns.

---

1. Apply one edge of the pad securely to the patient.



- Roll the pad smoothly from the applied edge to the other, being careful not to trap any air pockets between the gel and skin.

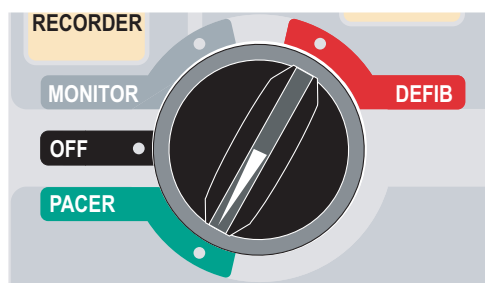


- Ensure that hands-free therapy electrodes are making good contact with the patient's skin and are not covering any part of any other ECG electrodes.
- If using OneStep Pacing electrodes or OneStep Complete electrodes, select ECG lead P1, P2, or P3; otherwise, select an appropriate ECG lead. Adjust ECG size for a clean, well-defined ECG signal.
- Verify proper R-wave detection. The heart-shaped symbol flashes with each R-wave when proper detection is taking place. Adjust ECG size for a clean, well-defined ECG signal.

**Note:** When the OneStep Pacing electrode configuration is used and the unit is switched to **PACER** mode, P3 is automatically selected as the ECG source. When separate ECG electrodes and hands-free therapy electrodes are used, Lead II is automatically selected as the ECG source.

While ECG signals acquired from P1, P2 or P3 are appropriate for ECG rhythm assessment and determining electrical capture during pacing, they should not be used for diagnostic purposes. Conventional ECG electrodes and cable should be used for this purpose.

## 2 Turn Selector Switch to PACER



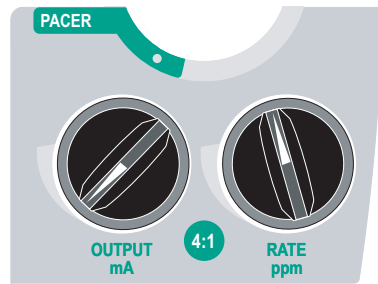
### Set the Pacer Output to 0 mA

If the unit has just been turned on, the **PACER OUTPUT** is automatically set to 0 mA.

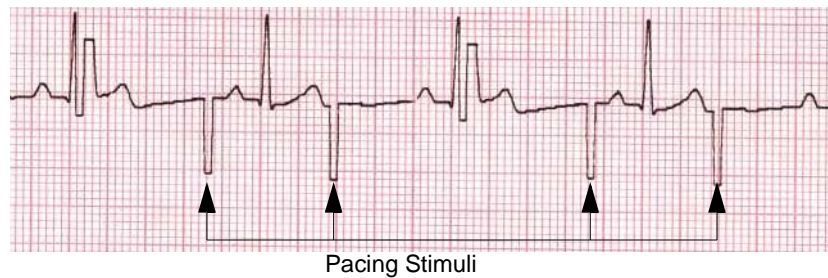
## 3 Set Pacer Rate

Set the **PACER RATE** to a value 10-20 ppm higher than the patient's intrinsic heart rate. If no intrinsic rate exists, use 100 ppm.

The pacer rate increments or decrements by a value of 2 ppm on the display when the knob is turned.

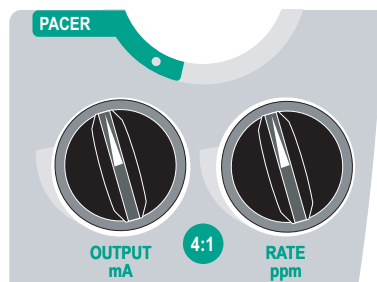


Observe the pacing stimulus marker on the display or stripchart (  $\square$  ) and verify that it is well-positioned in diastole.



#### 4 Set Pacer Output

Increase **PACER OUTPUT** until stimulation is effective (capture); the output mA value is displayed. The pacer output increments and decrements by a value of 2 mA on the display when the knob is turned.



**Note:** When the unit is switched out of PACER mode into DEFIB or MONITOR mode and then switched back to PACER mode, within 10 seconds the pacer settings remain unchanged.

If the unit is turned off for more than 10 seconds, the pacer's power up default settings are restored.

## 5 Determine Capture

It is important to recognize when pacing stimulation has produced a ventricular response (capture). Determination of capture must be assessed both electrically and mechanically in order to ensure appropriate circulatory support of the patient.

Electrical capture is determined by the presence of a widened QRS complex, the loss of any underlying intrinsic rhythm, and the appearance of an extended, and sometimes enlarged, T-wave.

Ventricular response is normally characterized by suppression of the intrinsic QRS complex.

---

**WARNING!** Determination of electrical capture should only be performed by viewing the ECG trace on the R Series display with its ECG connection directly attached to the patient. Use of other ECG monitoring devices might provide misleading information due to the presence of pacer artifacts.

---

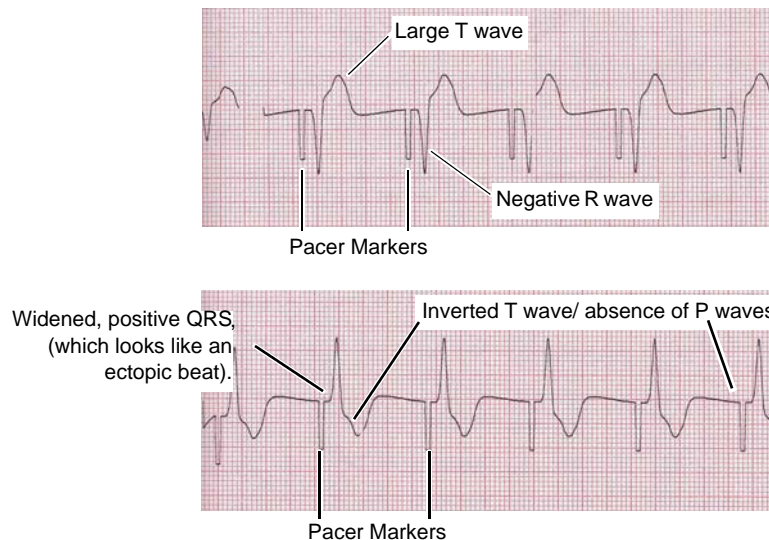
Mechanical capture is assessed by palpation of the peripheral pulse.

To avoid mistaking muscular response to pacing stimuli for arterial pulsations, use **ONLY** the following locations for palpating pulse during pacing:

- femoral artery
- right brachial or radial artery

### Effective pacing

The following ECG traces illustrate typical examples of effective pacing.



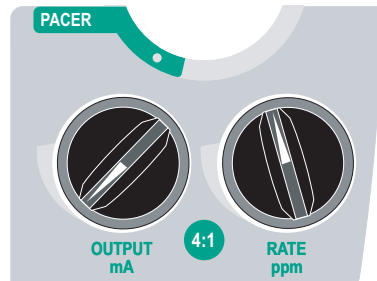
Changing ECG leads and size can sometimes be helpful in determining capture.

**Note:** The shape and size of the paced ECG waveforms can vary depending on the ECG lead configuration chosen; variation from patient to patient can be expected.

## 6 Determine Optimum Threshold

The ideal pacer current is the lowest value that maintains capture — usually about 10% above threshold. Typical threshold currents range from 40 to 80 mA. Location of the hands-free therapy or OneStep therapy electrodes affects the current required to obtain ventricular capture. Typically the lowest threshold is obtained when the position of the electrodes provides the most direct current pathway through the heart while avoiding large chest muscles. Lower stimulation currents produce less skeletal muscle contraction and are better tolerated.

### 4:1 Mode



Pressing and holding the 4:1 button temporarily withholds pacing stimuli, thereby allowing you to observe the patient's underlying ECG rhythm and morphology.

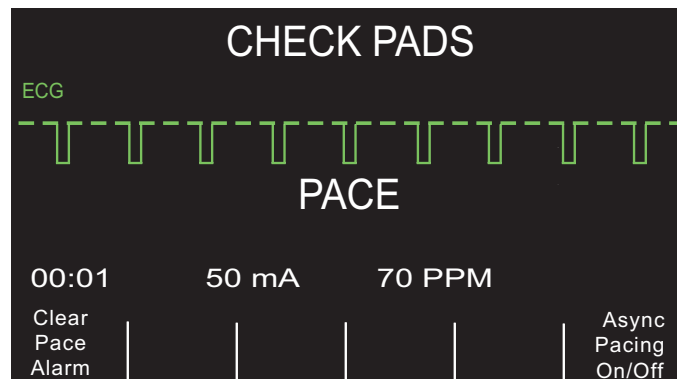
When depressed, this button causes pacing stimuli to be delivered at  $\frac{1}{4}$  of the indicated ppm setting.

### Pace Fault

If the unit is attempting to deliver pacing therapy and one of the following conditions occur, the messages *CHECK PADS* and *POOR PAD CONTACT* are alternately displayed on the screen and an audible alarm sounds:

- The OneStep cable is not connected to the device.
- The cable is defective.
- Therapy pads are not connected to the OneStep cable.
- The therapy pads are not making good skin contact.

The alarm will continue to sound until proper connections between the patient and pacer are achieved and the leftmost softkey (**Clear Pace Alarm**) is pressed.



---

## Special Pacing Applications

Noninvasive Temporary Pacing can be performed in the Cardiac Catheterization Lab either for emergency pacing or standby pacing. For pacing in X-ray and fluoroscopic applications, ZOLL Pro-padz® radiolucent hands-free therapy electrodes may be used.

Noninvasive Temporary Pacing can be performed in the Operating Room using ZOLL Pro-padz sterile hands-free therapy electrodes.

---

**Caution** Under certain conditions, it may not be possible to properly monitor or pace while electrosurgical apparatus is operating. Interference caused by use of electrosurgical apparatus may result in a *CHECK PADS* or *LEADS OFF* message. If a *CHECK PADS* message is present, the unit will not deliver energy. Observe the device carefully for evidence of proper operation.

---

### Standby Pacing

For certain patients at risk of developing symptomatic bradycardia, it may be advisable to use the unit in standby mode. When used in standby mode, the unit automatically provides pacing stimuli whenever the patient's heart rate drops below the pacer rate setting. Patient's ECG must be monitored using one of the two electrode configurations described on page 8-2. To use the device in standby mode:

1. Establish effective pacing (see instructions on previous pages). Note the mA output at capture and run an ECG stripchart to document ECG morphology during capture.
2. Set the mA output 10% higher than the minimum mA output necessary to effect consistent ventricular capture.
3. Turn the pacing rate (ppm) below the patient's heart rate. This suppresses pacing unless the patient's own rate drops below the pacer rate setting. The pacing rate should be set at a level sufficient to ensure adequate cardiac output.
4. Check the threshold periodically.

### Asynchronous Pacing

If ECG electrodes are not available or there is some circumstance that prevents or interferes with the surface ECG, the R Series delivers pacemaker pulses asynchronously.

Asynchronous pacing should be performed only in an emergency when no alternative is available. To pace asynchronously:

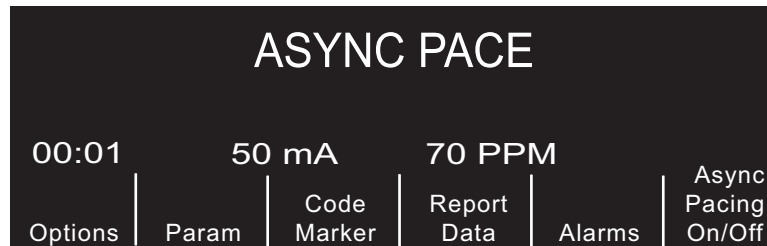
**Turn the Mode Selector to PACER.**

**Press the Async Pacing On/Off softkey.**

**Note:** If the pacer output is set to 8 mA or higher, pacing stimuli begin immediately at the set rate.

The display shows "ASYNC PACE" to indicate that asynchronous pacing has been activated. The annotation "ASYNC PACE" is also printed on the stripchart when activated by the

**RECORDER** button, and printed on the corresponding summary report. To return to demand pacing, press the **Async Pacing On/Off** softkey again. The display returns to “PACE.”



Pace stimuli are also delivered asynchronously whenever there is an *ECG LEAD OFF* condition. Due to the lead off condition, no ECG waveforms will be displayed when pacing by this method. Use other means to determine capture such as checking the patient’s pulse.

When asynchronously pacing with an *ECG LEAD OFF* condition, the rate and mA should be set at the known capture level or high enough (100mA) to presume capture.

## Pediatric Pacing

Noninvasive pacing of pediatric patients is performed in an identical manner to adult pacing. Smaller size pediatric therapy electrodes are available for patients weighing less than 55 lbs/25 kg. Continuous pacing of neonates can cause skin burns. If it is necessary to pace for more than 30 minutes, periodic inspection of the underlying skin is strongly advised. Carefully follow all instructions on electrode packaging.

# Chapter 9

## ECG Monitoring

---



ECG leads are a defibrillation-protected Type CF patient connection.

The R Series products can be used for either short- or long-term ECG monitoring.

R Series products have built-in circuitry to prevent damage to their ECG monitoring circuits during defibrillation. Monitoring electrodes, however, can become polarized during defibrillator discharge, causing the ECG trace to briefly disappear from the screen. High-quality silver/silver chloride (Ag/AgCl) electrodes minimize this effect. Circuitry in the unit returns the ECG trace to the display within a few seconds.

You can monitor a patient's ECG using an ECG patient cable, hands-free therapy electrodes, or through standard defibrillation paddles.

During ECG monitoring, the R Series displays the following information:

- Five seconds of ECG waveforms
- Heart Rate
- Heartbeat indicator
- ECG source lead (I, II, III, aVR, aVL, aVF, or V with ECG cable; PADS, or PADDLES)
- ECG size relative scale factor - x0.5, x1, x1.5, x2, x3
- Alarm indicator

Whenever more than one waveform is displayed, the selected ECG lead appears as the uppermost trace (unless the unit is configured for Filtered ECG).

**Caution** ECG electrodes embedded in OneStep Pacing and Complete resuscitation pads produce non-standard ECG monitoring lead vectors, designated P1, P2 and P3. While ECG signals acquired from these leads are appropriate for ECG rhythm assessment and determining electrical capture during pacing, they should not be used for ECG morphological evaluations. Attach conventional ECG electrodes for diagnostic purposes.

**Note:** Under certain clinical circumstances, the R Series heart rate counting system may respond to narrow, high-amplitude spikes in the ECG signal (e.g., 10 msec duration, 1 mV peak-to-peak amplitude) leading to miscounting of the patient's heart rate. Do not rely on heart rate meters if the ECG waveform contains narrow, high-amplitude spikes. If there is a question about the accuracy of heart rate counting, verify the patient's heart rate by taking his/her pulse.

## Preparations

Proper application and placement of electrodes is essential for high quality ECG monitoring. Good contact between the electrode and skin minimizes motion artifact and signal interference. Remove all clothing covering the patient's chest. Dry chest if necessary. If the patient has excessive chest hair, clip or shave it to ensure proper adhesion of the electrodes.

## Electrode Placement

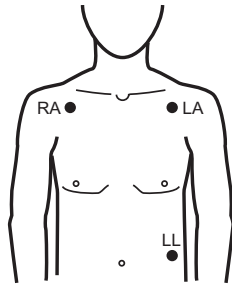
Depending upon local usage, the ECG leads are marked either RA, LA, LL, RL, and V or R, L, F, N and C. The following table shows the markings and color codes for the different lead sets.

IEC Color Coding	AHA Color Coding	Placement of Electrodes
R/Red Electrode	RA/White Electrode	Place near patient's right mid-clavicular line, directly below clavicle.
L/Yellow Electrode	LA/Black Electrode	Place near patient's left mid-clavicular line, directly below clavicle.
F/Green Electrode	LL/Red Electrode	Place between 6th and 7th intercostal space on patient's left mid-clavicular line.
N/Black*	RL/Green* Electrode	Place between 6th and 7th intercostal space on patient's right mid-clavicular line.
C/White* Electrode	V/Brown* Electrode	Single movable chest electrode.

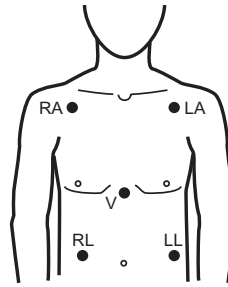
\* Not used for 3-lead monitoring



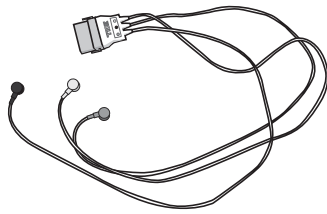
3-lead configuration



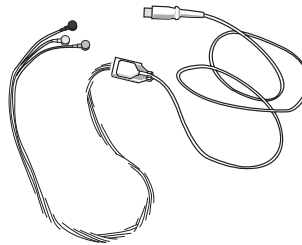
5-lead wire configuration



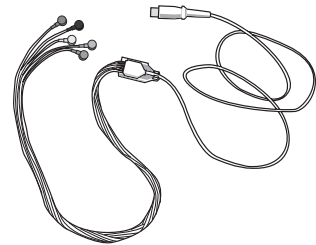
3-lead set



3-lead cable



5-lead cable



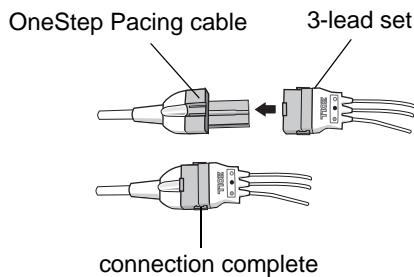
**Note:** Lead sets and lead cables are different accessories and are not interchangeable. For 5-lead monitoring, use a 5-lead cable.

**Note:** 3-lead cables are available with and without Electro Surgical Unit noise suppression. If the R Series unit is being used in the presence of an ESU, ablation device, or any other high electromagnetic noise emitting source, ZOLL recommends using the R Series 3-Lead ECG Cable, ESU Filtered (PN: 9500-000693) specifically designed to limit ESU artifact when monitoring heart rates.

## Monitoring Electrodes Attachment

Attach snap-on leads to electrodes and check for good contact between the electrode and the lead termination.

If you are using a 3-lead set, connect the end of the 3-lead set to a OneStep Pacing cable.



Peel the protective backing from the ECG electrode. Be careful to keep adhesive surface free of electrolyte gel.

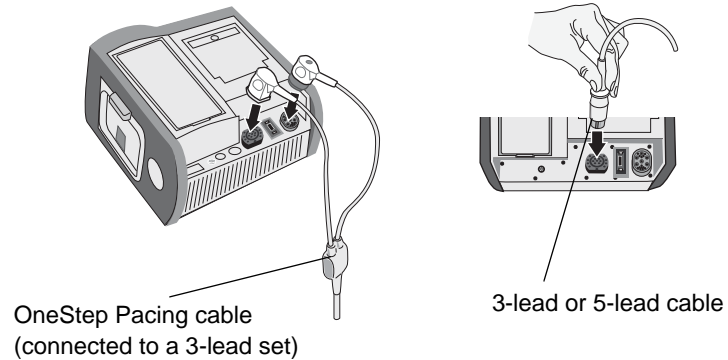
**Caution** Only use electrodes that are well within the expiration date indicated on the package.

---

Apply the ECG electrodes firmly to the patient's skin, pressing around the entire perimeter of the electrodes.

Plug the patient cable connector into the black ECG input connector (located on the rear panel of the instrument).

**Note:** If you are using a 3-lead set that is connected to a OneStep Pacing cable, plug the red connector into the red OneStep cable input connector on the device, and plug the connector (that is black inside) into the black ECG input connector on the device.



---

**Caution** To avoid electrosurgery burns at monitoring sites, ensure proper connection of the electrosurgery return circuit so that the return paths cannot be made through monitoring electrodes or probes.

---

During electrosurgery, observe the following guidelines to minimize ESU interference and provide maximum user and patient safety:

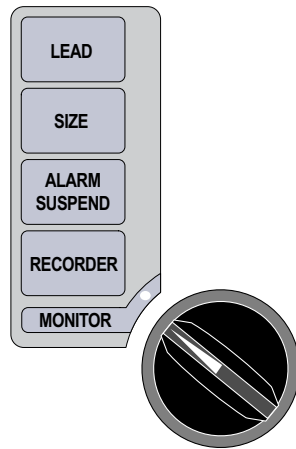
- Keep all patient monitoring cables away from earth ground, ESU knives, and ESU return wires.
- Use electrosurgical grounding pads with the largest practical contact area.

Always assure proper application of the electrosurgical return electrode to the patient.

# Monitoring the Patient's ECG

## Set the Controls

Set the Mode Selector to **MONITOR**, then press the **LEAD** button until the desired lead configuration is selected. The selected lead is indicated at upper right of the display.



If the unit displays the *ECG LEAD OFF*, *POOR LEAD CONTACT*, or *CHECK PADS* message, inspect the ECG electrodes or therapy electrodes, lead wires, and cables for proper connections.

If heart rate alarms are enabled with paddles selected, the unit displays the messages *SELECT LIMB LEADS* and *VF ALARMS OFF*. If you see these messages, select limb or precordial leads.

If you want to change the size of the displayed ECG waveform, press the **SIZE** button until the desired waveform size is displayed. Options are 0.5, 1, 1.5, 2, and 3 times the normal size.

If you want to shut off the heart rate beeper, press the **Options**, then the **QRS VOL OFF** softkeys. To turn it back on, press the **QRS VOL ON** softkey.

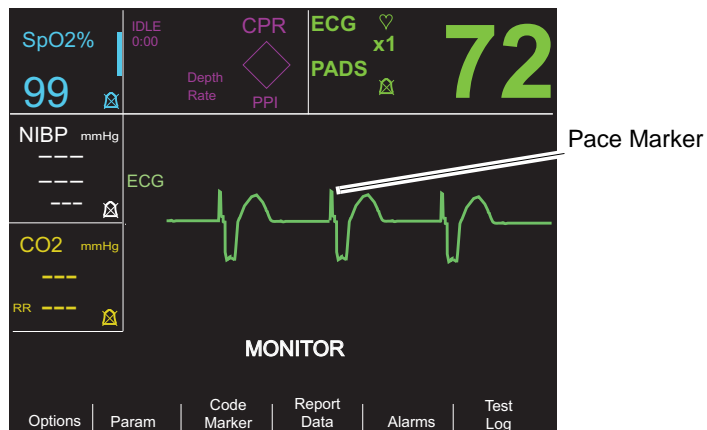
---

**WARNING!** **Implanted pacemakers may cause the heart rate meter to count pacemaker pulses during incidents of cardiac arrest or other arrhythmias. Pacemaker patients should be carefully observed. Check the patient's pulse; do not rely solely on heart rate meters. Dedicated pacemaker detection circuitry may not detect all implanted pacemaker spikes; patient history and physical exam are important in determining the presence of an implanted pacemaker.**

---


## Implanted Pacemakers

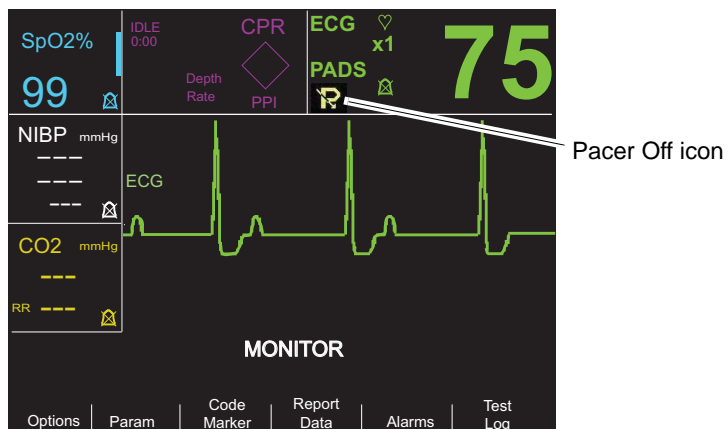
The R Series device can be configured to detect pacemaker signals from a patient with an implanted pacemaker and indicate their presence on the display. When pacemaker pulses are detected, the device displays a 5mm, vertical, solid line on the ECG trace.



To disable detection of pacemaker spikes:

1. Press the **Param** softkey.
2. Press **ECG**.
3. Press **Disable Pacer Detect**.

The Pacer Off icon () appears in the ECG field to indicate that detection and rejection of implanted pacemaker pulses by the heart rate detector is disabled. Do not disable the implanted pacemaker detector when monitoring patients known or suspected to have an implanted pacer. Disabling pacemaker pulse detection under these conditions can result in erroneously counting pacemaker pulses as R-waves leading to the display of inaccurate heart rates.



To re-enable detection of pacemaker spikes:

1. Press the **Param** softkey.
2. Press **ECG**.
3. Press **Enable Pacer Detect**.

---

## 5-Lead Monitoring

You can perform 5-lead ECG monitoring with the appropriate ECG patient cable. The 5-lead cable allows you to monitor the following ECG leads:

- I, II, III
- aVR, aVL, aVF
- V1

### Changing from 3-Lead Monitoring

To change from 3-lead to 5-lead monitoring, simply disconnect the 3-Lead ECG patient cable (or OneStep Pacing cable ECG connector) and connect the 5-lead ECG cable. Refer to the beginning of this section for appropriate preparations (i.e., placing electrodes, attaching electrodes, setting the controls, etc.).

If any ECG lead becomes disconnected during monitoring, an *ECG LEAD OFF* message appears on the display.

### Changing from 5-Lead ECG Monitoring

To change from 5-lead monitoring to 3-lead monitoring, you must power off the unit for at least 10 seconds, remove the 5-lead cable, connect the 3-lead cable, then power on the unit again. If you fail to shut the unit off for at least 10 seconds, the unit displays the *ECG LEAD OFF* message after you disconnect the 5-lead wire cable, even if leads from a 3 lead ECG cable are properly attached to the patient.

## Simultaneous 3-Lead Printing

The R Series unit can display and print three simultaneous ECG leads when using a 5 lead cable and an ECG lead is selected as the signal source (not PADS or PADDLES).

**Note:** This feature does not work with a 3 lead cable.

To display and print 3 simultaneous leads:

1. Press the **Options** softkey, then press the **Traces** softkey.
2. Press **3 Leads**.

Leads belong to two groups: limb leads (I, II and III) and augmented leads (aVR, aVL, and aVF). The selected lead is always displayed and printed in the Trace 1 uppermost position. The other two leads are displayed in the Trace 2 and 3 positions. For example, if aVL is the selected Trace 1 lead, the Trace 2 and 3 positions display aVR, and aVF respectively.

3 ECG leads will also be printed (when an ECG lead is selected) if the “Print 3 Leads When Leads are Sel.” configuration option is set to YES. Refer to the *R Series Configuration Guide* for instructions.

## See-Thru CPR Filter (Optional)

When OneStep CPR electrodes or OneStep Complete electrodes are in use, the R Series unit allows simultaneous display and printing of the selected ECG lead and the same ECG lead with CPR filtering applied. The CPR filter uses signals from the electrode’s CPR sensor to help reduce artifact in the ECG signal caused by mechanical compressions of the chest, thereby

providing a clearer view of the ECG during periods of CPR. For more detailed information on this feature, see Chapter 7, "See-Thru CPR (Optional)".

To apply the See-Thru CPR Filter to the selected ECG lead and display it:

1. Press the **Options** softkey, then press the **Traces** softkey.
2. Press the **Trace 2** or **Trace 3** softkey.
3. Press **Filt ECG**.

If Display Filtered ECG in Trace1 is configured, the unit displays the filtered ECG in Trace1. You can then switch between filtered and unfiltered ECG using the **Enable/Disable Filt ECG** softkey. With the unfiltered ECG displayed in Trace1, the user of the R Series unit can also enable the display of the filtered ECG in Trace2 or Trace3.

## Adding Traces to Be Displayed

The screen can display up to three traces simultaneously. The trace for the selected ECG lead always appears in the Trace 1 uppermost position.

If optional physiological monitoring parameters are installed in the unit, the operator can select applicable traces to appear in the second or third position.

To select the display for the second or third trace:

1. Press the **Options** softkey, then press **Traces**.
2. Press **Trace 2** or **Trace 3** to select the position.
3. Press the softkey for the parameter or other waveform to display in the selected position (or **Off** to clear that position).

**Note:** Trace 3 is not available while the unit is in Pacer mode.

## Printing the ECG on a Stripchart

The stripchart recorder documents the ECG trace with a 6 second delay at all times. To start the stripchart recorder, press the **RECORDER** button. The stripchart recorder runs continuously until you press the button again.

Each time the strip chart recorder is started, the time, date, ECG lead, size, and heart rate are printed on the top part of the paper. If the unit is pacing, the output current is also printed.

**Note:** Check the paper supply at the beginning of each shift and after each use to ensure adequate recording capability. A colored stripe on the paper means that the paper supply is low.

A *CHECK RECORDER* message appears on the display when the stripchart recorder is activated without paper. The stripchart recorder automatically shuts off when there is no paper.

After loading new paper, press the **RECORDER** button to start the strip chart recorder.

## Diagnostic Bandwidth

When using an ECG cable for monitoring, you can switch the unit to diagnostic bandwidth (0.05-150 Hz) by pressing and holding the **RECORDER** button depressed. Diagnostic bandwidth is maintained and printing continues as long as the **RECORDER** button is held down. The unit reverts to standard monitoring bandwidth when you release the **RECORDER** button.

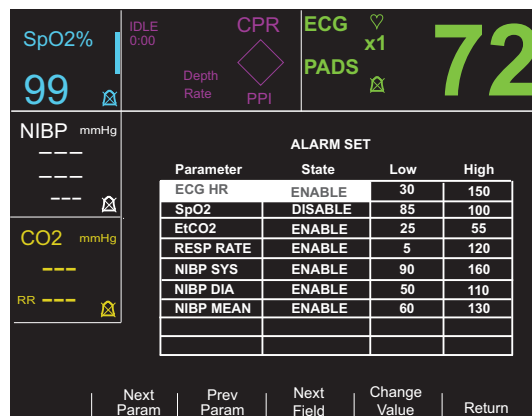
# Alarms

## Setting Alarm Limits

Unless configured otherwise, heart rate alarms are preset at 30 bpm (bradycardia) and 150 bpm (tachycardia). Refer to the *R Series Configuration Guide* for details on setting power-up alarm limits.

To set alarm parameters:

1. Press the **Alarms** softkey to view the Alarm Set screen and softkeys.



Each setting includes the alarm state (ENABLE, DISABLE, or AUTO) and the low and high limit of the acceptable range of values.

2. Press the **Next Param** or **Prev Param** softkey.

This scrolls the highlighted area among the different available vital signs.

If you want to change the state of the highlighted vital sign:

- a. Press the **Change Value** softkey.
- b. Press the **Inc >** or **Dec <** softkey to change the state value.
- c. Press the **Enter** softkey.

The State field can be set to three possible values, Enable, Disable, or Auto.

- Disable permanently turns off alarm processing for the selected physiological parameter.
- Enable causes alarm processing to operate whenever alarms are activated via the front panel **ALARM** key.
- Selecting AUTO sets the lower and upper alarm limits to 80% and 120% of the patient's currently measured heart rate, if valid measurements are present for the vital sign when the **Enter** softkey is pressed. (Refer to appropriate Operator's Guide parameter insert(s) for percentages associated with other parameters).

3. Press the **Next Field** softkey to move to the Low or High field for the highlighted vital sign; repeat steps 2a through 2c to change the Low or High value.

**Note:** To recalculate the Low and High limits for any parameter when these limits have previously been set using the AUTO State, follow the procedure above to select AUTO again, and then press the **Enter** softkey. The unit automatically resets the Low and High limits based upon the currently measured value of the selected physiological parameter.

4. Press the **Return** softkey to set all values and return to normal operating mode.

## Heart Rate Alarm Limits

The heart rate is displayed in the upper right-hand corner of the screen.

Unless configured otherwise, heart rate alarms are preset at 30 bpm (bradycardia) and 150 bpm (tachycardia). The low heart rate alarm limit range is 20 bpm to 100 bpm.

When the unit is monitoring a patient's heart rate via ECG, the range for the high heart rate alarm limit is 60 to 280 bpm with a default setting of 150 bpm. When the unit is monitoring a patient's pulse rate via pulse oximetry (SpO<sub>2</sub>), however, the unit automatically lowers the upper limit for the high heart rate alarm to 235 bpm. The unit restores the original high heart rate alarm limit when ECG monitoring resumes.

## Vital Sign Alarms

Each vital sign has associated high and low alarm limits. You can set alarm limits for patient heart rate and other optional monitoring parameters such as pulse oximetry (SpO<sub>2</sub>), non-invasive blood pressure (NIBP), or end-tidal carbon dioxide monitoring (EtCO<sub>2</sub>), if available.

The R Series unit has three levels of alarms:

- **High Priority** — Reflects physiological parameters that are out of bounds. When these alerts occur, the unit emits an audio tone at 2.86 KHz, highlights the alarming parameter, and flashes the associated alarm bell.
- **Medium Priority** — Reflects equipment- related, user correctable faults such as *LEAD OFF*. The unit emits a two beep audio tone and displays a message for a timed period.
- **Low Priority** — Informational message only; the unit emits a two beep audio tone and displays a message for a timed period.

## Suspending and Silencing Alarms

When a high priority alarm occurs, the unit emits a continuous alarm tone, highlights the value of the alarming parameter on the display, and flashes the bell icon associated with that parameter.

You can either suspend the alarm tone for 90 seconds or you can silence the alarm tone.

### Suspending Alarm Tones



To suspend an alarm tone for 90 seconds, press and release the **ALARM SUSPEND** button in *less than 1 second*. The alarm tone stops, the unit displays an “X” across the alarm's flashing bell icon, and the value for the alarming parameter remains highlighted. (If you press the **ALARM SUSPEND** button again, alarm processing is reactivated.)

After 90 seconds, if the physiological parameter remains at a value that triggers the alarm, the unit sounds the alarm tone again.



If the alarm condition clears (the physiological parameter returns to a value within range) after you suspend the alarm tone, the unit resets the alarm and displays the bell icon (no flashing, no “X”). The alarm parameter displays normally (no highlighting).



If a second, different alarm occurs after you suspend an alarm tone, you can suspend the alarm tone for that second parameter by pressing and releasing the **ALARM SUSPEND** button again. The unit behaves the same as described above for the first alarm. Suspending a second alarm does not alter the timing or processing of the previously suspended alarm.

### Silencing Alarm Tones



To silence the alarm tone, *press and hold down* the **ALARM SUSPEND** button for *between 1 and 3 seconds*. The alarm tone stops, the unit displays the alarm's bell icon in inverse video with an "X" across it, and the value of the alarm parameter remains highlighted. (If you press the **ALARM SUSPEND** button again, alarm processing is reactivated.)

The alarm tone will not sound again as long as the physiological parameter's value remains out of range.



If the alarm condition clears (the physiological parameter returns to a value within range) after you silence the alarm tone, the unit resets the alarm and displays the bell icon (no inverse video, no "X"). The alarm parameter value displays normally (no highlighting).

After the unit resets an alarm, should the physiological parameter again go out of range, it will trigger the alarm.

### Activating and Deactivating Alarm Processing



To deactivate all alarms on the R Series unit, *press and hold down* the **ALARM SUSPEND** button *for 3 seconds or longer*. The bell icons for all alarms will have an "X" through them to indicate that the alarms are deactivated. Alarm parameter values display normally (no highlighting).

To reactivate the alarms, press and release the **ALARM SUSPEND** button in *less than 1 second*.

## Smart Alarms

In **DEFIB** or **MONITOR** mode, ECG/heart rate alarm capabilities are enhanced with the defibrillation advisory feature called Smart Alarms. When alarms are operating, this feature triggers an audible alarm and displays the message *CHECK PATIENT* whenever the unit detects ventricular fibrillation or wide complex ventricular tachycardias. This message appears on the display and the stripchart recorder print out.

If alarms are operating in **PACER** mode, the unit displays *VF ALARMS OFF*, indicating that the Smart Alarms feature has been disabled.

The Smart Alarms feature is always disabled when augmented leads (aVR, aVL, aVF), V-leads, or PADDLES are selected for ECG monitoring. The messages *VF ALARMS OFF* and *SELECT LIMB LEADS* are alternately displayed when alarms are activated and augmented leads or V-leads are selected. These messages are displayed only the first time you select the augmented or V-leads. They are not redisplayed as you cycle through the lead selection.

## **Alarm Settings for Unattended Monitoring**

Alarms for all monitored parameters should be activated whenever a patient is left unattended. Alarm limits should be intentionally set to levels appropriate for detecting relevant changes in the patient's condition. Leaving alarm settings at their default levels or setting them to the extremes of their ranges may defeat the utility of the alarms even when they are activated.

# Chapter 10

## Event Records and Reports

---

The R Series defibrillator records important event information during operation. You can retrieve this information in various forms:

- **Summary Report** — Summary report allows you to store and later retrieve important ECG and event information. You can print summary report information in various formats. For more information about Summary Report and how to print a report, refer to the Summary Report section below.
- **Full Disclosure Recording** — Full Disclosure waveforms along with event information are stored and may be reviewed using ZOLL CodeNet Central software. For information about Full Disclosure Recording, refer to “Full Disclosure Recording” on page 10-8.
- **Incident Log** — The Incident log is an abbreviated list of all major events recorded in Summary Report. For more information about the Incident log and how to print it, refer to “Printing an Incident Log” on page 10-8.

### Summary Report

The R Series defibrillator automatically records defibrillation and cardioversion events, PACER mode information, heart rate alarms, and segments of ECG when the recorder is activated. Associated event information including device control settings, time, and date are also recorded.

The following events trigger Summary Report to automatically record information:

- Power is turned on.
- Stripchart recorder is turned on.
- Defibrillator shock is administered.
- Code markers entered.
- ECG rhythm analysis is initiated.
- VF alarm is triggered.

- Parameter alarm is triggered.
- Mode Selector is turned to PACER.

**Note:** Diagnostic bandwidth recordings are not included in Summary Report.

The unit stores and prints summary information in chronological order. The memory allocated for summary data can hold up to 350 defibrillation or 350 recorder-activated events. All event data remains in memory and is accessible until data is manually erased or until the preconfigured time interval has elapsed. (The time interval is specified in the Set Report Restart Delay parameter; see the *R Series Configuration Manual* for more information). A new patient record is automatically created when the unit has been turned off for a configurable time period of 5 minutes to 72 hours. When all memory for code summary is used, the unit issues the message *REPORT FULL*.

To continue recording the code event after the memory has been filled or to prepare the unit for a new code, the operator can erase the stored records. (Refer to “Erasing Summary Report and Full Disclosure” on page 10-9.)

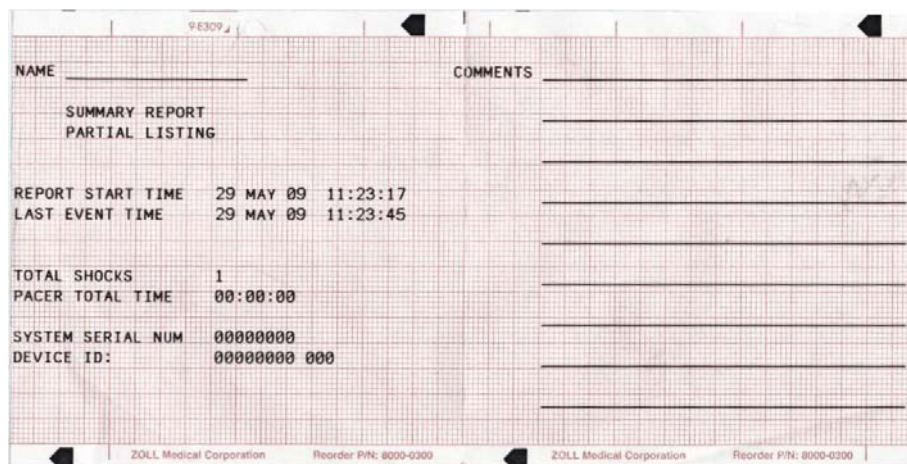
## Summary Report Formats

This section describes the information included with each type of summary report record.

Each summary report begins with an overview of all events currently stored in memory including:

- Date and time
- Report start time (either when the unit was turned on or, if data was manually erased, when subsequent recording began)
- Time of the last recorded event
- Total number of shocks delivered
- Cumulative pacing time
- Device ID
- System serial number

Space is provided for patient name and comments. On the last event recorded, the unit prints “SUMMARY COMPLETE” on the bottom left of the stripchart.



**Figure 10-1. Summary Report**

### Defibrillation Event Format

The summary report function records 6 seconds of pre-shock and 9 seconds of post-shock patient ECG data. Also recorded are joules selected, joules delivered, Sync if active (includes Sync markers), ECG lead, ECG size, patient current, defib impedance, actual time and date. The date/time printed on the top of the strip corresponds to the ECG data occurring 6 seconds before the event.

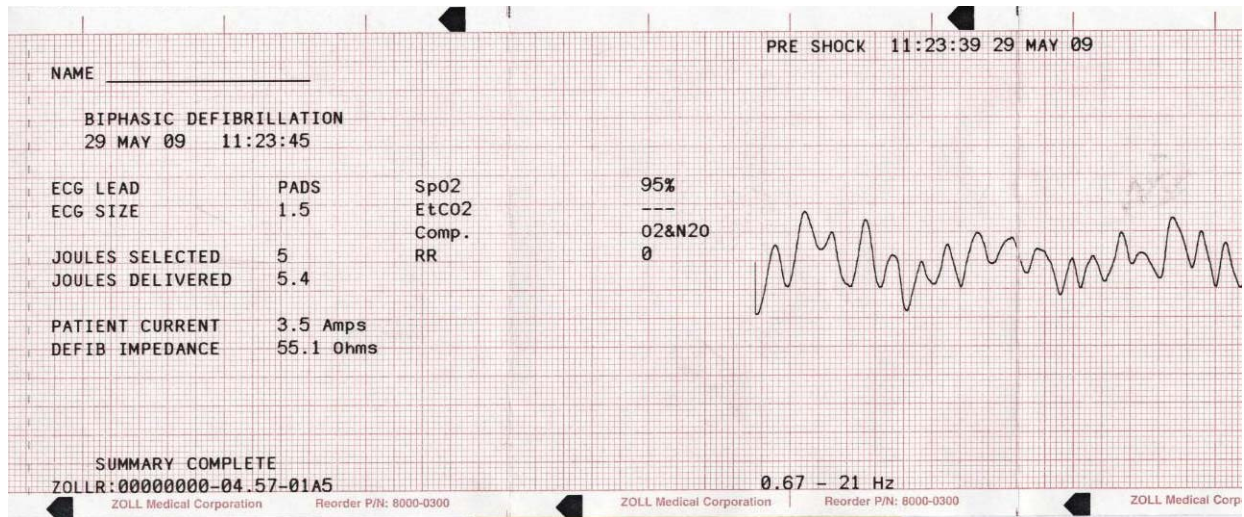


Figure 10-2. Defibrillation Event Format (Pre-Shock)

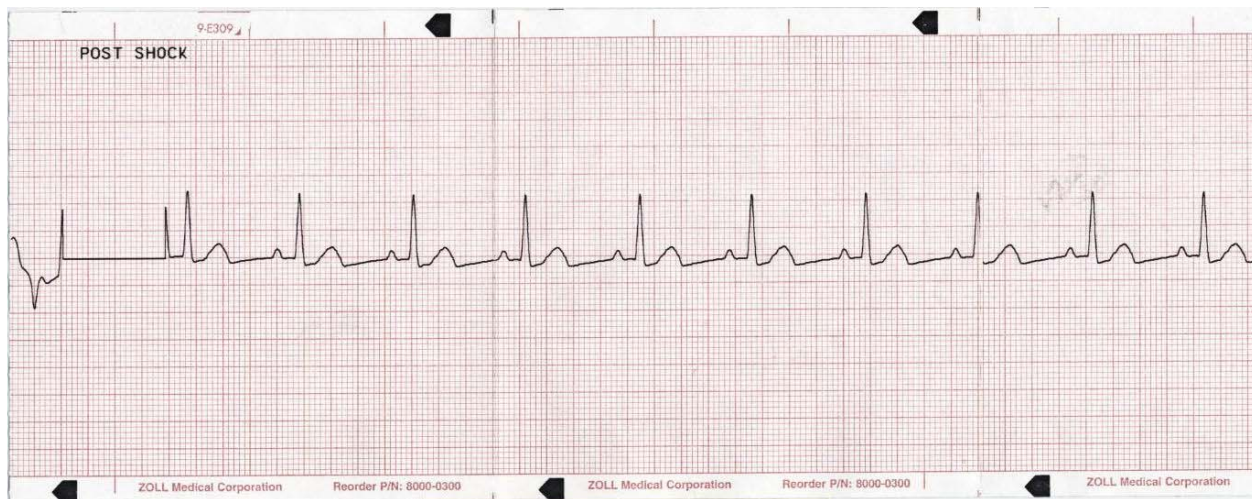


Figure 10-3. Defibrillation Event Format (Post Shock)

### Pacer Mode Selected Format

The summary report function records 6 seconds of pre-pace patient ECG data. Also recorded are the ECG lead, ECG size, patient's heart rate, pace rate, pace current, time and date. The date/time printed on the top of the strip corresponds to the ECG data occurring 6 seconds before the event.

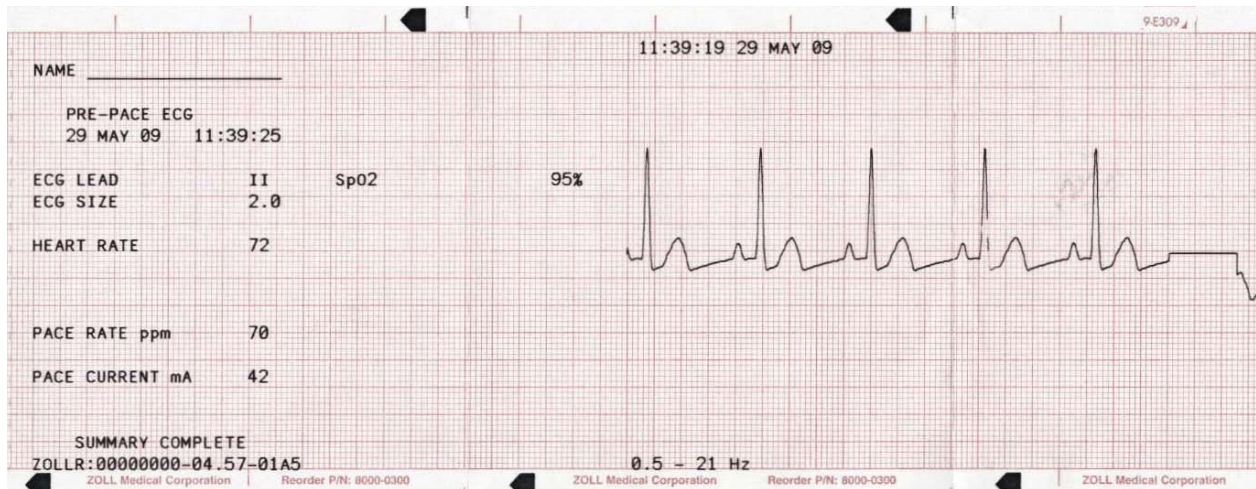


Figure 10-4. Pacer Mode Selected Format

After establishing a paced rhythm, turning the recorder on briefly records the paced rhythm for later reports. If Async pace is active, the annotation *ASYNC PACE* is also recorded and printed. The date/time printed on the top of the strip corresponds to the ECG data occurring 6 seconds before the event.

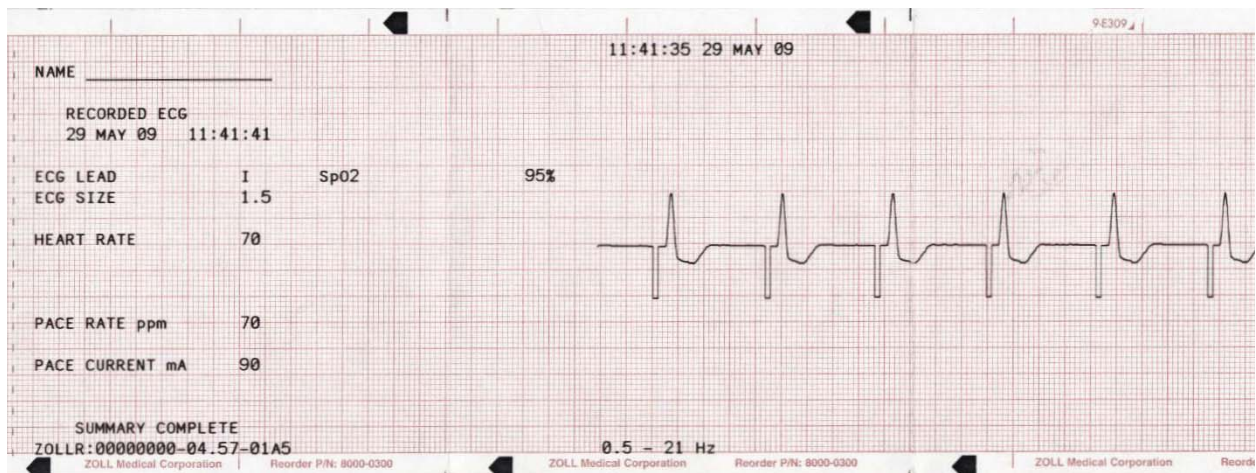


Figure 10-5. Pacer Mode Selected Format (Asynchronous Pacing)

### Heart Rate Alarm Activated Format

The summary report function records 6 seconds of pre-alarm patient ECG. Also recorded are the ECG lead, ECG size, patient's heart rate, actual event time, and date. The date/time printed on the top of the strip corresponds to the ECG data occurring 6 seconds before the event. If the pacer is on during this event, the pacing rate and pacing current are also recorded.

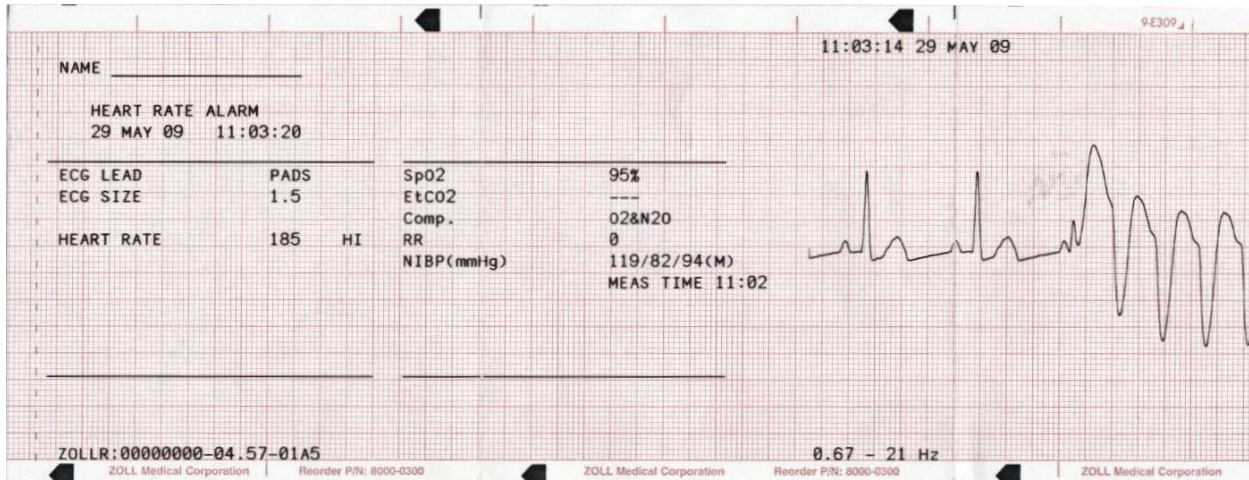


Figure 10-6. Heart Rate Alarm Activated Format

### VF Alarm Activated Format

The summary report function records 18 seconds of patient ECG data associated with each VF alarm. Also recorded are the ECG lead, ECG size, actual event time, the number of noise events, and the message *CHECK PATIENT*. The date/time printed on the top of the strip corresponds to the ECG data occurring 6 seconds before the event.

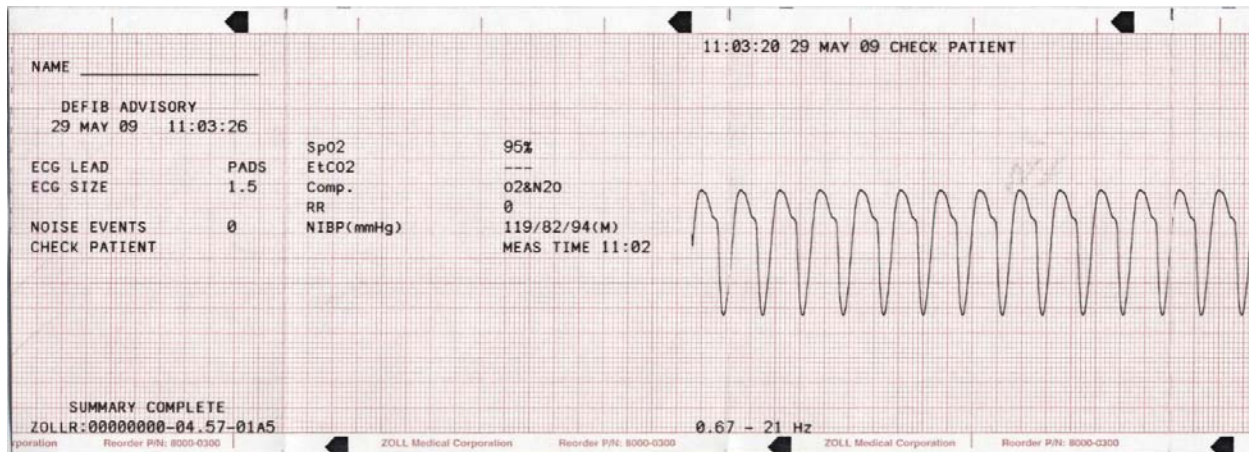


Figure 10-7. VF Alarm Activated Format

### Recorder On Format

The summary report function records 6 seconds of patient ECG prior to turning on the recorder. Also recorded are the ECG lead, ECG size, patient's heart rate, actual event time, and date. The date/time printed on the top of the strip corresponds to the ECG data occurring 6 seconds before the event. If the pacer is on during this event, the pacing rate and current are also recorded. If Async pace is active, the annotation *ASYNC PACE* is recorded.

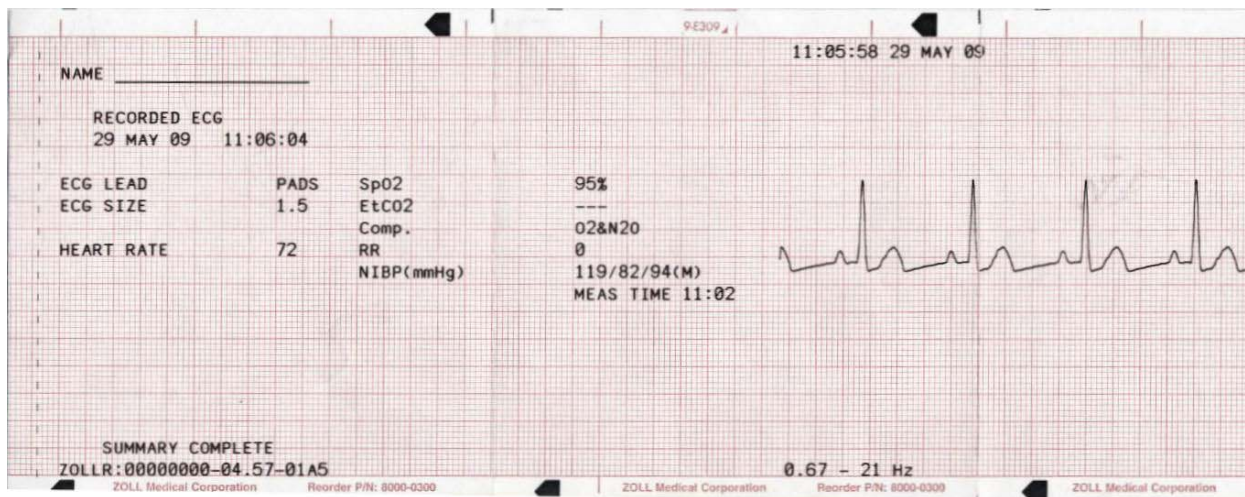


Figure 10-8. Recorder On Format

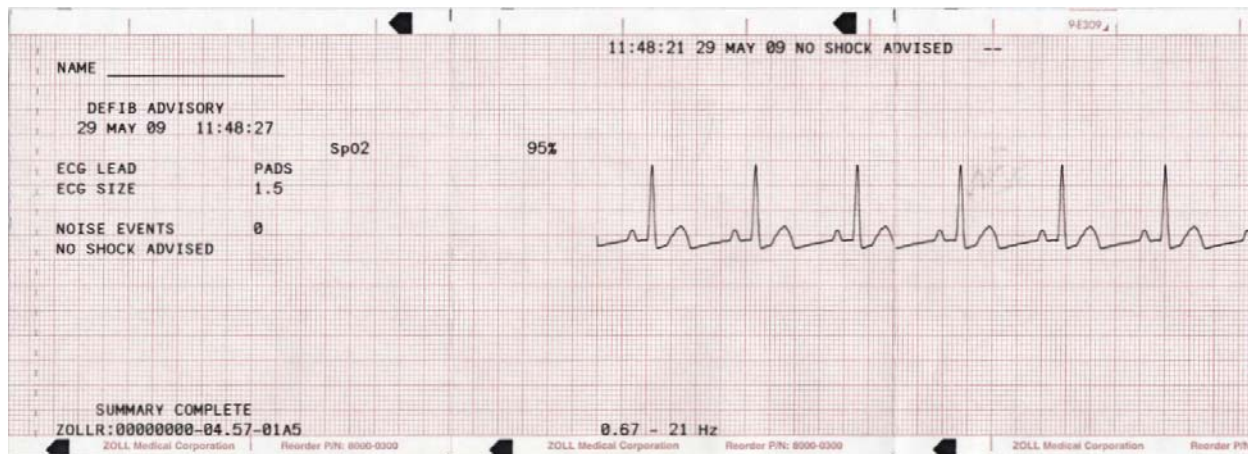
### Analyze Format

The summary report function records six seconds of pre analysis ECG, 12 seconds of ECG recorded during the analysis and the annotation *SHOCK ADVISED* or *NO SHOCK ADVISED*. The date/time printed on the top of the strip corresponds to the ECG data occurring 6 seconds before the analysis was started.

The analysis normally consists of three consecutive 3-second ECG rhythm analyses. Each segment is represented at the top of the strip with either an asterisk (\*) for shockable, or a dash (-) for non shockable. The unit automatically charges to the preconfigured energy level upon detection of the first shockable segment. If at least two of the three analyses determine that the patient has a shockable rhythm, the unit will prompt the operator to shock the patient. If two or more of the three 3-second ECG analyses do not detect a shockable rhythm, the unit alerts the operator that no shock is advised.



**Note:** If the first two segments are shockable, only two asterisks appear on the stripchart, and the third segment is not analyzed.



**Figure 10-9. Analyze Format**

In addition, the ECG rhythm analysis report can include the following annotations:

Annotation	Description
<i>POOR PAD CONTACT</i>	The hands-free therapy electrodes are improperly connected.
<i>ANALYSIS HALTED</i>	A fault condition occurred, or the operator pressed the <b>ANALYZE</b> button again.
<i>NOISY ECG</i>	Excessive noise was detected.
<i>SHOCK ADVISED</i>	A shockable rhythm was detected.
<i>NO SHOCK ADV.</i>	No shockable rhythm was detected.

## Printing the Entire Summary Report

To print all summary report data:

1. Press the **Report Data** softkey, then press **Print Chart**.
2. Press the **Print All** softkey.

The unit prints all stored code events and code markers in chronological order beginning with the oldest entry. If the stripchart recorder is on or the defibrillator is charged, summary report printing is disabled. To stop printing a report, press the **RECORDER** button or turn off the unit. You can print an unlimited number of copies of the report by repeating this procedure.

**Note:** Summary report printing is interrupted when a, ECG analysis is in progress, or the defibrillator is charging or charged. Also, if a summary report is printing and you press the **Report** softkey to print another type of report (such as the log report), the device stops printing the summary report and begins printing the selected report.

If the recorder is out of paper when the **Report Data** softkey and a corresponding print softkey are pressed, a *CHECK RECORDER* message appears on the display. Load paper and press the **Report Data** softkey again to select the report to print.

## Printing a Partial Summary Report

To print a partial summary report:

1. Press the **Report Data** softkey, then press **Print Chart**.
2. Press the **Print Range** softkey.
3. Use the **First Event**, **Prev. Event**, **Next Event** and **Last Event** softkeys to locate the event from which printing will start (all subsequent events are also printed).
4. Press the **Print** softkey.

The unit prints all records from the selected item to the most recent.

**Note:** The overview information (such as the number of shocks delivered) covers all stored summary data, not just the selected range.

## Full Disclosure Recording

Along with event information captured in Summary Report, R Series also records the full disclosure CPR sensor and parameter waveforms. The full disclosure recording on the unit can accommodate at least 6 hours of data.

Full disclosure recordings are erased at the same times as Summary Reports.

## Incident Logs

An incident log is an abbreviated list of all major events recorded in summary report. You can print an incident log that includes the following events and their time of occurrence.

- Unit powered on.
- Defibrillation advisory message issued (for example, *CHECK PATIENT* or *SHOCK ADVISED*)
- Shock delivered (and energy level)
- PACER mode selected
- Alarm triggered
- Stripchart printing started
- Code marker entered

In addition, the incident log lists the following:

- System serial number
- Device identification number
- Report start time (when the summary data was last erased)
- Time of the last recorded event
- Total number of shocks delivered
- Total cumulative pacing time

## Printing an Incident Log

To print an incident log, press the **Report Data** softkey, then press the **Print Log** softkey.

The log is printed on the stripchart, starting with the oldest entry.

# Erasing Summary Report and Full Disclosure

Summary information can be erased either manually or automatically.

## Manual Erasure

You can manually erase summary records and full disclosure data from memory in preparation for collecting data for a new patient.

**Note:** When the event summary memory and full disclosure memory are filled, data recording stops. You must erase the records to continue recording.

Make sure to print out any important summary records currently in memory. Transfer important full disclosure records to ZOLL CodeNet Central.

To manually erase stored data:

1. Press the **Report Data** softkey.
2. Press the **Erase** softkey, then the **Erase Report** softkey. To erase all reports stored in the unit, press **Erase All**.

## Automatic Erasure

Automatic erasure of summary report and full disclosure data occurs if the R Series unit has been turned off for a user-configurable period of 5 minutes to 72 hours.

## Formatting the Disk

The R Series uses an internal flash memory disk that stores the data in files similar in structure to those on a personal computer hard drive. Like a personal computer, there may be rare occasions when the internal disk requires formatting. For example, this may occur if all power (battery and ac) is removed while erasing a report. Under such a circumstance, the message *DISK FORMAT REQ.* will be displayed. Perform the following steps to format the flash memory disk. All patient data will be erased during this procedure. If possible, print out any important summary records currently in memory and transfer important full disclosure records to ZOLL CodeNet Central.

1. Press the **Report Data** softkey.
2. Press the **Erase** softkey, then the **Format Disk** softkey.
3. When you are ready, press the **Confirm Format** softkey.

The messages *FORMATTING DISK* and *DO NOT POWER OFF* will be displayed while the disk is formatting. This procedure may take several minutes to complete.

## Related Messages

Message	Description
<i>CHECK RECORDER</i>	The paper supply in the stripchart printer is exhausted.

<b>Message</b>	<b>Description</b>
<i>DISK FORMAT REQ.</i>	The internal flash memory disk file system has been corrupted. Follow the procedure in the previous section, "Formatting the Disk."
<i>DO NOT POWER OFF</i>	Do not remove power (both battery and AC) while the unit is erasing reports or formatting the disk.
<i>ERASING REPORT</i>	The unit is erasing the selected report data.
<i>FORMATTING DISK</i>	The internal flash memory disk is being formatted.

# Chapter 11

## File Transfer

---

This chapter describes procedures for transferring files from the R Series defibrillator to an external system, such as a personal computer or handheld device. It also explains how to remove, install and erase a Compact Flash card.

### Transferring Files to an External Device

You can transfer the following files from the R Series defibrillator to an external device:

- Device check, activity log, and full disclosure waveforms
- Defibrillator test information

The unit includes the following data transfer features:

- 802.11 Wi-Fi (optional)
- USB device connector (optional)
- Compact flash card slot

To retrieve and review event files, you need one of the following software packages installed on the receiving equipment:

- ZOLL CodeNet Central software
- ZOLL RescueNet Code Review software

To retrieve and review maintenance files, you need ZOLL Defib Dashboard software installed on the receiving equipment.

R Series defibrillators use the Microsoft Windows file structure for stored records. Files can be transferred to a properly equipped Windows-based personal computer or handheld device. With CodeNet Central software, the personal computer allows the user to access the files for review.

If configured, the unit can display a reminder to transfer files while in clinical mode. When turned off, the unit displays the message *TURN UNIT ON AND ENTER DATA TRANSFER MODE TO TRANSFER REPORT* for 15 seconds. This is turned off by default; see the *R Series Configuration Guide* to change this setting.

## Wi-Fi (Optional)

The R Series has an optional Wireless Ethernet function that transfers data files using the IEEE 802.11 protocol (Wi-Fi). This includes a ZOLL R Series Data COMM Card or ZOLL R Series Data COMM II card, and a protective guard that must be installed on the unit. See *R Series Data COMM Instructions for Use and Wi-Fi Guard Installation* (Part number 9652-000395) or *R Series Data COMM II Instructions for Use and Wi-Fi Guard Installation* (Part number 9652-000405) for instructions on how to install the Wi-Fi Guard.

Do not clean the Wi-Fi Data COMM or Data COMM II Card with isopropyl alcohol.

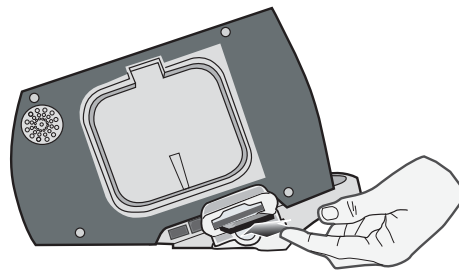
All file transfer operations are terminated when the defibrillator is switched to either Defib mode or Pacing mode, or powered off.

## Installing or Removing a Compact Flash Card

Before you begin, check the card and its connector to ensure that they are clean and undamaged.

### To install a compact flash card:

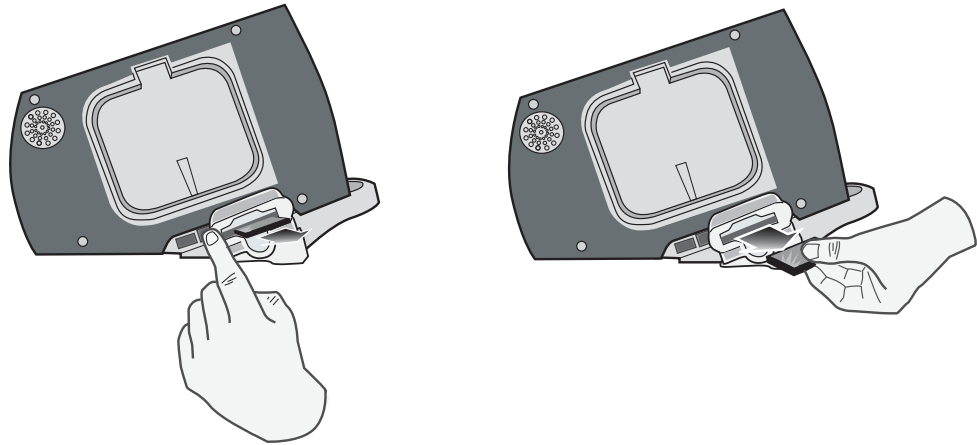
1. Insert the card, with its label side up, into the front slot on the lower left side of the unit.  
You can install a compact flash card while the unit is operating or while it is turned off.
2. Slide the card into the slot until it is firmly seated.



**Figure 11-1. Inserting Compact Flash Card**

**To remove a compact flash card:**

Press the release button and pull the card out of the slot.



**Figure 11-2. Removing a Compact Flash Card**

## Transferring a Full Disclosure File to a Compact Flash Card

Make sure that a compact flash card is installed in the slot on the left side of the device.

To transfer data to a compact flash card:

1. Turn the Mode Selector to **MONITOR**.
2. Press the **Report Data** softkey.
3. Press the **Transfer Mode** softkey.
4. Press the **Report to Card** softkey.

The message *TRANSFERRING DATA* is displayed. All data is transferred to the installed CF data card.

**Note:** Do not remove the CF card while files are transferring. Corruption may result on the data card.

When all files are transferred, the message *DATA TRANSFERRED* is displayed. You can now remove the CF card from the R Series unit.

To exit Data Transfer mode, press the **Exit Transfer** softkey.

## Transferring Device Check and Activity Log Files to a Compact Flash Card

Make sure that a compact flash card is installed in the slot on the left side of the device.

To copy the Code Readiness Log to a CF card:

1. Turn the mode selector to **MONITOR**.

2. Press the **Report Data** softkey.
3. Press the **Transfer Mode** softkey.
4. Press the **More** softkey.
5. Press the **Defib History to Card** softkey.

The message *TRANSFERRING DATA* is displayed. All data is transferred to the installed CF data card.

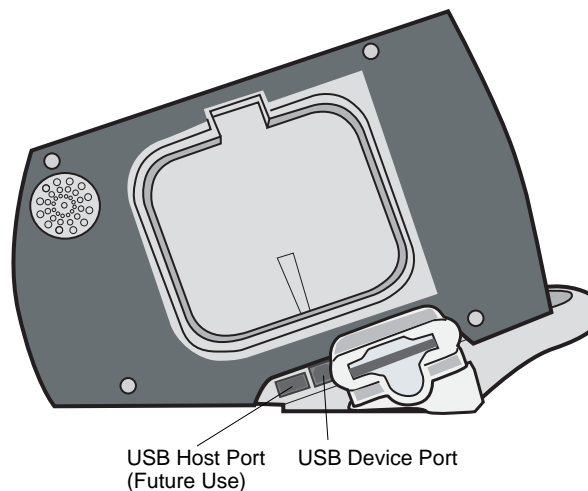
**Note:** Do not remove the CF card while files are transferring. Corruption may result on the data card.

When all files are transferred, the message *DATA TRANSFERRED* is displayed. You can now remove the CF card from the R Series unit.

To exit the Data Transfer mode, press the **Return** softkey and then the **Exit Transfer** softkey.

## Transferring Files Through the USB Port (Optional)

Before you begin, connect a USB cable from the Windows external device with USB host capability (for example, a Window PC), to the R Series defibrillator USB device port.



**Figure 11-3. USB Ports**

To transfer data through the USB port:

1. Turn the Mode Selector to **MONITOR**.
2. Press the **Report Data** softkey.
3. Press the **Transfer Mode** softkey.
4. Press the **More** softkey.
5. Press the **Enable USB** softkey.  
The R Series is now in USB Transfer Mode.
6. Initiate data transfer using ZOLL CodeNet Central.

To exit USB Transfer mode, press the **Disable USB** softkey or switch the Mode Selector to **DEFIB**, **PACER** or **OFF**.

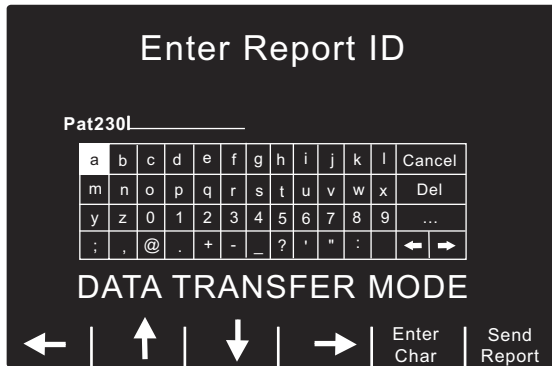


## Transferring Full Disclosure Files Through Wi-Fi (Optional)

Before you begin, ensure the Wi-Fi card is properly seated with the name R Series Data COMM or Data COMM II facing up in the compact flash slot. Make sure that the Wi-Fi guard has been attached.

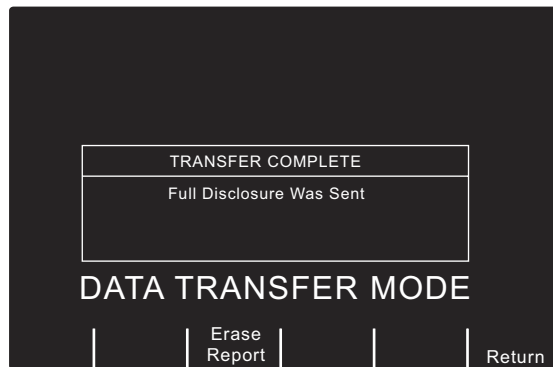
To transfer data through Wi-Fi:

1. Turn the Mode Selector to **MONITOR**.
2. Press the **Report Data** softkey.
3. Press the **Transfer Mode** softkey.
4. Press the **Report to Wi-Fi** softkey.
5. The Enter Report ID screen will appear, and you will be prompted to enter a unique report ID. Use the arrow keys to select the desired characters, then press the **Enter Char** softkey. Pressing the ... key will change the table to a different set of characters, including upper case letters. To cancel and return to the previous screen, use the arrow keys and select Cancel.



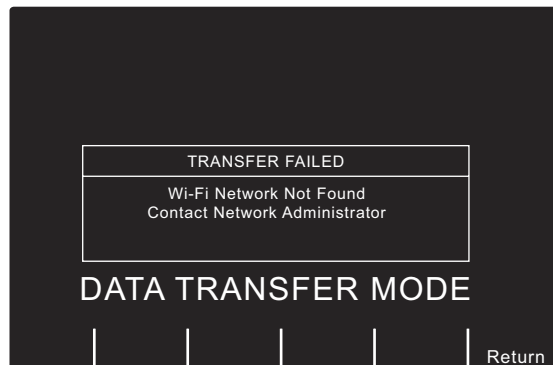
**Note:** Enable Report ID must be enabled in System Configuration mode for the report screen to appear (See the *R Series Configuration Guide*). If Enable Report ID is set to No, then the screen will not be displayed and the report will be sent immediately.

6. To send the report, press the **Send Report** softkey. The R Series is now in Wi-Fi Transfer Mode and a status text message box appears in the middle of the screen and describes the status of the file being sent. When the full disclosure file is transferred, the messages *TRANSFER COMPLETE* and *Full Disclosure Was Sent* are displayed.



7. To erase the report, press the **Erase Report** softkey. To keep the report and return to the Transfer Mode screen, press the **Return** softkey.

**Note:** If you are out of the range of an access point, the data will not be transferred and the message *Wi-Fi Network Not Found* is displayed. Press the **Return** softkey to return to the previous menu and try again.



To exit Wi-Fi/DataTransfer Mode, press the **Return** softkey and then the **Exit Transfer** softkey or switch the Mode Selector to **OFF**.

## Transferring Device Check and Activity Log Files Through Wi-Fi (Optional)

Before you begin, ensure the Wi-Fi card is properly seated with the name R Series Data COMM or Data COMM II facing up in the compact flash slot. Make sure that the Wi-Fi guard has been attached.

To transfer data through Wi-Fi:

1. Turn the Mode Selector to **MONITOR**.
2. Press the **Report Data** softkey.
3. Press the **Transfer Mode** softkey.
4. Press the **More** softkey.
5. Press the **Defib History to Wi-Fi** softkey.

The R Series is now in Wi-Fi Transfer Mode and a status text message box appears in the middle of the screen and describes the status of the files being sent. When the files are transferred, the messages *TRANSFER COMPLETE*, *Device Check Was Sent*, and *Activity Log Was Sent* are displayed.

**Note:** If you are out of the range of an access point, the data will not be transferred and the message *Wi-Fi Network Not Found* is displayed.

To exit Wi-Fi/DataTransfer Mode, press the **Return** softkey and then the **Exit Transfer** softkey or switch the Mode Selector to **OFF**.

## Related Wi-Fi Messages

Informational Message	Description
<i>INITIALIZING NETWORK</i>	A transfer has been initiated.
<i>CONNECTING TO THE NETWORK</i>	The association with the host network is being established.
<i>CONNECTING TO SERVER</i>	The unit is connecting to a remote system.
<i>TRANSFER IN PROGRESS</i>	The data transfer is in progress.
<i>WAITING FOR SERVER RESPONSE</i>	The unit is waiting for the final acknowledgment from a remote system.
<i>TRANSFER COMPLETE</i> <i>XX Was Sent</i>  XX=file type (Full Disclosure, Activity Log, or Device check)	The data transfer is complete (and lists the file type that was sent).
Error Message	Description/Action
<i>TRANSFER FAILED</i> <i>Wi-Fi Card Not Detected</i> <i>Verify Installation of Wi-Fi Card</i>	The transfer failed because no Wi-Fi card is installed in the CF slot, or the card was ejected from the slot during transmission.  <b>Action:</b> Make sure that the correct Wi-Fi card is properly installed in the unit.
<i>TRANSFER FAILED</i> <i>Wi-fi Card Not Configured</i> <i>Contact Network Administrator</i>	The Wi-Fi card's configuration data is corrupt or blank.  <b>Action:</b> Verify the configuration settings on the Wi-Fi card. Contact the Network Administrator for assistance.
<i>TRANSFER FAILED</i> <i>Invalid Wi-Fi configuration</i> <i>Error Number: N</i> <i>Contact Network Administrator</i>	The transfer failed because the Wi-Fi configuration was illegal. N indicates one of following error codes:  <i>N = 1: Local Static IP settings</i> <b>Action:</b> 1) If running in Static IP mode, make sure that the relevant static IP addresses are not 0.0.0.0. 2) Make sure the subnet mask is in the correct format.  <i>N = 2: Server Static IP address</i> <b>Action:</b> With DNS set to No, make sure that the IP addresses for the Full Disclosure Server and Defib History Server are not 0.0.0.0.  <i>N = 3: Server Name</i> <b>Action:</b> With DNS set to Yes, make sure that valid names exist for the Full Disclosure Server and the Defib History Server.  <i>N = 4: DNS IP address</i> <b>Action:</b> With DHCP set to No and DNS set to Yes, make sure that the DNS IP Address is not 0.0.0.0.  <i>N = 5: SSID</i> <b>Action:</b> Make sure that there is at least one valid SSID for each desired mode (infrastructure and data management server).

	<p>N = 6: Missing required configuration data for Network Profile 1 with Enterprise Authentication selected (Data COMM II only)</p> <p><b>Action:</b> Check the following:</p> <p>If Authentication Protocol is set to PEAP, make sure that the following are configured:</p> <ul style="list-style-type: none"> <li>• User Identity</li> <li>• User Password</li> </ul> <p>If Authentication Protocol is set to TLS, make sure that the following are configured:</p> <ul style="list-style-type: none"> <li>• User Identity</li> <li>• Private Key Password</li> <li>• Client Certificate</li> </ul> <p>N = 7: Missing required configuration data for Network Profile 2 with Enterprise Authentication selected (Data COMM II only)</p> <p><b>Action:</b> Same as above.</p> <p>N = 8: The Defib Upload Server's Username / Password are blank within the Full Disclosure and Defib History server configuration items (Data COMM II only)</p> <p><b>Action:</b></p> <p>If Full Disclosure Transfer Mode is set to Server, make sure that the Username (Full Disclosure) and Password (Full Disclosure) entries are valid.</p> <p>If Defib History Transfer Mode is set to Manual, Automatic, or Both, make sure that the Username (Defib History) and Password (Defib History) entries are valid.</p> <p>N = 9: Missing required certificate file for Network Profile 1 with Enterprise Authentication selected (Data COMM II only)</p> <p><b>Action:</b></p> <p>If Authentication Protocol is set to PEAP, make sure that a root certificate has been added (if not using the default ZOLL root certificate).</p> <p>If Authentication Protocol set to TLS, make sure that a root certificate has been added (if not using the default ZOLL root certificate) and that the correct client certificate has been configured.</p> <p>N = 10: Missing required certificate file for Network Profile 2 with Enterprise Authentication selected (Data COMM II only)</p> <p><b>Action:</b> Same as above.</p>
--	---

*Transferring Device Check and Activity Log Files Through Wi-Fi (Optional)*

<p><i>TRANSFER FAILED</i>  <i>Network Error: General</i>   <i>Error Number: NNNN</i>  <i>Contact Network Administrator</i></p>	<p>The transfer failed because of a general network Wi-Fi error. NNNN may indicate one of the following error codes:</p> <p>N = 7004  N = 7010  N = 7011  N = 7015  N = 7016  <b>Action:</b> Install another Data COMM card.</p> <p>N = 7500  N = 7501  N = 7502  N = 7503  N = 7504  N = 7505  N = 7506  N = 7507  <b>Action:</b> Install another Data COMM II card.</p> <p>N = 7017  <b>Action:</b> Make sure that the Defib Upload Server is running, is operational, and can be reached on the network.</p>
<p><i>TRANSFER FAILED</i>  <i>Network Error: Unknown [-7002]</i></p>	<p><b>Action:</b> Make sure that no illegal characters are used for the SSID names.</p>
<p><i>TRANSFER FAILED</i>  <i>Wi-Fi Card Failure</i>  <i>Error Number: -7009</i>  <i>Contact Network Administrator</i></p>	<p>The Wi-Fi card's configuration data is corrupt or cannot be read. (Data COMM only)</p> <p><b>Action:</b>  Install another Data COMM card. Contact the Network Administrator for assistance.</p>
<p><i>TRANSFER FAILED</i>  <i>Wi-Fi Network Not Found</i>  <i>Contact Network Administrator</i></p>	<p>The R Series could not associate with a Wi-Fi network.</p> <p><b>Action:</b></p> <ol style="list-style-type: none"> <li>1) Make sure that the configuration values for the SSID names are correct.</li> <li>2) Make sure that the R Series unit is within range of the wireless server.</li> <li>3) Contact the Network Administrator for assistance.</li> </ol>
<p><i>TRANSFER FAILED</i>  <i>Could Not Connect To Server</i>  <i>Contact Network Administrator</i></p>	<p>The R Series could not communicate with the DefibUpload Server.</p> <p><b>Action:</b></p> <ol style="list-style-type: none"> <li>1) Make sure that the DefibUpload Server is running, is operational, and can be reached on the network.</li> <li>2) If WEP is enabled, make sure that the WEP keys on the R Series and Access Point match (value and slot location).</li> <li>3) Make sure that the server port is correct.</li> </ol>

<p><i>TRANSFER FAILED</i>  <i>Network Error: DHCP</i>  <i>Contact Network Administrator</i></p>	<p>The DHCP request has failed.</p> <p><b>Action:</b></p> <ol style="list-style-type: none"> <li>1) If WEP is enabled, make sure that the WEP keys on the R Series and Access Point match (value and slot location).</li> <li>2) Make sure that the DHCP server is operational.</li> </ol>
<p><i>TRANSFER FAILED</i>  <i>Network Error: DNS</i>  <i>Contact Network Administrator</i></p>	<p>The DNS request has failed.</p> <p><b>Action:</b></p> <ol style="list-style-type: none"> <li>1) Make sure that the DNS server is running, operational, and properly configured.</li> <li>2) Make sure that the R Series configuration values pertaining to the server names (Full Disclosure and Defib History) are correct.</li> </ol>
<p><i>TRANSFER FAILED</i>  <i>Full Disclosure Service Not Available</i>  <i>Contact Network Administrator</i></p>	<p>The option to accept full disclosure files is not enabled on the server.</p> <p><b>Action:</b> Contact the Network Administrator for assistance.</p>
<p><i>TRANSFER FAILED</i>  <i>Defib History Service Not Available</i>  <i>Contact Network Administrator</i></p>	<p>The option to accept Defib History files is not enabled on the server.</p> <p><b>Action:</b> Contact the Network Administrator for assistance.</p>
<p><i>TRANSFER FAILED</i>  <i>Server Rejection</i>  <i>Contact Network Administrator</i></p>	<p>The server rejected the unit's request.</p> <p><b>Action:</b> Contact the Network Administrator for assistance.</p>
<p><i>TRANSFER FAILED</i>  <i>Unsupported Wi-Fi Card</i>  <i>Verify Installation of Wi-Fi Card</i></p>	<p>The card installed in the CF slot is not an R Series Data COMM or Data COMM II card.</p> <p><b>Action:</b> Make sure that the correct Wi-Fi card is properly installed in the unit.</p>
<p><i>TRANSFER FAILED</i>  <i>Unsupported Wi-Fi Card</i>  <i>Update Wi-Fi Card</i></p>	<p>The card installed in the CF slot is an incorrect version. (Data COMM II only)</p> <p><b>Action:</b> Install a Data COMM II card that is the latest version.</p>
<p><i>TRANSFER FAILED</i>  <i>Authentication Error</i></p>	<p>The encryption passphrase/key is incorrect.</p> <p><b>Action:</b> Contact the Network Administrator for assistance.</p>
<p><i>TRANSFER FAILED</i>  <i>Invalid Certificate</i>  <i>Contact Network Administrator</i></p>	<p>Could not associate to an SSID using WPA/WPA2 Enterprise security because one or more of the certificates is invalid or expired. (Data COMM II only)</p> <p><b>Action:</b> Contact the Network Administrator for assistance.</p>
<p><i>TRANSFER FAILED</i>  <i>Invalid Credentials</i>  <i>Contact Network Administrator</i></p>	<p>Could not associate to an SSID using WPA/WPA2 Enterprise security because one or more of the credentials were invalid. (Data COMM II only)</p> <p><b>Action:</b> Contact the Network Administrator for assistance.</p>

# Chapter 12

## Maintenance

---

Defibrillator equipment must be maintained to be ready for immediate use. The defibrillator should be tested daily. The R Series defibrillator gives you two readiness testing options:

- Automatic
- Manual

**Note:** Both automatic and manual test results are automatically recorded to internal memory.

Maintenance Frequency	
Visual Inspection	Once per day, inspect Code Readiness indicator.
Code Readiness Test (Automatic)	Once per day, unless configured Off, in which case, perform manual defibrillator testing daily.
Manual Defibrillator Testing	Once per week; daily if Code Readiness Test is configured Off.

When the R Series device ships from ZOLL, the Code Readiness indicator may show a red “X.” A manual readiness test should be performed (in addition to other site-specific tests such as HiPot and Leakage) prior to putting the device into service. Follow the procedure on page 12-3, and verify that the Code Readiness indicator displays a green “✓.”

# Routine Procedures

## Daily Visual Inspection

### Equipment

Ensure that the unit is clean (with no fluid spills) and free of visible damage.

Inspect all cables, cords, and connectors for good condition (no cuts, fraying or bent pins).

Check that the paddle surfaces are clean and free of electrolyte gel and other contaminants.

### Supplies and Accessories

Verify the presence, proper condition and quantity of all disposable supplies (such as ECG monitoring electrodes, electrode gel, stripchart paper, alcohol swabs, razors, and antiperspirant).

Ensure that two sets of ZOLL therapy pads are available in sealed packages. Check the expiration date on all ZOLL therapy pad packages.

### Batteries/External Power Supply

Check that a fully charged battery pack is installed in the unit.

Check that a fully charged spare battery pack accompanies the unit, or that the unit has ready access to a local AC mains power outlet.

### Code Readiness Status

Look at the ✓/x Code Readiness indicator on the R Series defibrillator. If the Code Readiness indicator displays a red “X” the unit is not ready for therapeutic use.

Should the automatic Code Readiness test fail, the R Series unit sets its Code Readiness indicator to a red “X”. If the failed unit is connected to AC power, it will also display a Code Readiness status report highlighting the defibrillator functions or accessories that are compromised. If the failed unit is not connected to AC power, only the red “X” will display. Connect the unit to AC power. Turn the unit to MONITOR mode, then press the **Test Log** softkey to determine the problem. Readiness test reports can be displayed and printed as described in “Code Readiness Log” on page 12-6.

Take corrective actions (for example, replace electrodes), or remove the unit from service, and consult “Troubleshooting” on page 13-1.

While a red “X” indicates the unit is not ready for therapeutic use, the device will not prevent a user from attempting to deliver therapy. An example of a condition in which therapy delivery may still be possible is when expired electrodes are connected to the device.



## Code Readiness Test

The R Series defibrillator performs Code Readiness tests automatically to verify its integrity and readiness for emergency use. These tests verify the following:

- Battery — Verifies that the battery state of charge is sufficient for at least one hour of continuous monitoring and ten shocks at maximum energy.
- Therapy Electrodes— Verifies that OneStep Pacing, CPR, or Complete electrodes are attached to the unit and have not expired.

**Note:** The Code Readiness system automatically verifies the integrity of the specific electrodes listed above. Other electrodes (including members of the OneStep family) should be verified manually for connection, condition, and expiration date.

- ECG circuitry — Verifies that the ECG signal acquisition and processing electronics are functional.
- Defibrillator charge and discharge circuitry — Verifies that the defibrillator electronics are functional and can charge and discharge at 30 joules through the patient cable and into paddles, OneStep electrodes, or the Test Port.
- Microprocessor hardware and software — Verifies the proper function of the microprocessor electronics and the integrity of software.
- CPR circuitry and sensor — Verifies that the Real CPR Help circuits are functional (when OneStep CPR or Complete electrodes are attached).

To prepare for Code Readiness tests, do the following:

1. Connect the R Series to AC mains.
2. Do one of the following:
  - Connect unopened OneStep electrodes to the OneStep cable, (Unopened OneStep electrodes act as a test port. The test port capability no longer functions once the electrode package is opened and electrodes are deployed.)
  - Connect the OneStep cable to paddles, and seat the paddles in the paddle wells, (Verify adult paddles are installed and pushed all the way into the paddle wells.)or
  - Connect the OneStep cable to the test port.

After the successful completion of the readiness check, the Code Readiness indicator displays a green check, indicating that the unit is ready for therapeutic use. If configured, the R Series will print a test record following automatic test completion.

The unit performs an automatic device check, if configured to do so, once per day at the configured time. For information, refer to the *R Series Configuration Guide*.

## Manual Defibrillator Testing

The following test performs:

- Power-on sequence check.
- **SHOCK** button and delivered energy check.
- Pacer check.
- Recorder check.

If a *LOW BATTERY* message appears during testing, the battery is close to depletion and should be replaced or recharged.

### Before you begin

1. Connect the R Series to AC mains.
2. Do one of the following:
  - Connect unopened OneStep electrodes to the OneStep cable, (Unopened OneStep electrodes act as a test port. The test port capability no longer functions once the electrode package is opened and electrodes are deployed.)
  - Connect the OneStep cable to paddles, and seat the paddles in the paddle wells, (Verify adult paddles are installed and pushed all the way into the paddle wells.)or
  - Connect the OneStep cable to the test port.

Follow the instructions in either the next section, “Procedure for Testing with Paddles,” or in “Defibrillator Testing with Hands-Free Therapy Electrodes” on page 12-5.

## Defibrillator Testing with Paddles

---

**WARNING!** When performing this check, use your thumbs to operate the **SHOCK** buttons in order to avoid inadvertent shock. No portion of the hand should be near the paddle electrode plates.

---

To test the manual defibrillation function using paddles:

1. Turn the unit off for at least 10 seconds.
  2. Turn the Mode Selector to **DEFIB**.

The unit emits a four-beep tone indicating successful completion of the power-on self-test. The ECG source is PADDLES, and ECG size is X1. “*DEFIB 120J SEL*” appears on the display. The ECG trace appears as a solid line while the paddles are seated in the paddle wells.
  3. Press the **ENERGY SELECT** buttons to set the energy to 30 joules.
  4. Press the **CHARGE** button on the apex handle.
  5. When the charge-ready tone sounds, press the **ENERGY SELECT** buttons to change the selected energy to 20 joules.

The defibrillator will disarm itself.
  6. Press the **ENERGY SELECT** buttons to reset the energy to 30 joules.
- Note:** For testing, the unit discharges the defibrillator only if the energy is set to 30 joules.
7. Press the **CHARGE** button.

When the charge-ready tone sounds, the message *DEFIB 30J READY* appears.

8. Press paddles firmly into their wells and using your thumbs, simultaneously press and hold the **SHOCK** buttons (one on each paddle) until the shock is delivered.

The unit displays the message *30J TEST OK* and prints a stripchart indicating *30J TEST OK* and the delivered energy.

If the message *30J TEST FAILED* appears, contact appropriate technical personnel or the ZOLL Technical Service Department.

## Defibrillator Testing with Hands-Free Therapy Electrodes

To test the manual defibrillation function using hands-free therapy electrodes:

1. Turn the unit off for at least 10 seconds.
2. Turn the Mode Selector to **DEFIB**.

The unit emits a four-beep tone indicating successful completion of the power-on self-test. The ECG source is PADS, and ECG size is X1. “DEFIB 120J SEL,” and *DEFIB PAD SHORT* appear on the display. The ECG trace appears as a solid line while the OneStep cable is connected to either the Test Port or OneStep electrodes.

3. Press the **ENERGY SELECT** buttons to set the energy to 30 joules.
4. Press the **CHARGE** button on the front panel.
5. When the charge-ready tone sounds, press the **ENERGY SELECT** buttons to set the energy to 20 joules.

The defibrillator will disarm itself.

6. Press the **ENERGY SELECT** buttons to reset the energy to 30 joules

**Note:** For testing, the unit discharges the defibrillator only if the energy is set to 30 joules.


7. Press the **CHARGE** button on the front panel.
8. When the Ready tone sounds, press the **SHOCK** button on the front panel until the shock is delivered.

The unit displays the message *30J TEST OK* and prints a stripchart indicating *30J TEST OK* and the delivered energy.

If the message *30J TEST FAILED* appears, contact appropriate technical personnel or the ZOLL Technical Service Department.

## Pacer Testing

1. Turn the Mode Selector to **PACER**.
2. Turn the **PACER RATE** control to 150 ppm, then press the **RECORDER** button.

On the stripchart, verify that pacing stimulus markers (  ) occur approximately every centimeter (10 small divisions or 2 large divisions).

3. Press and hold the **4:1** button.

The frequency of the pacing stimulus markers decreases, occurring approximately every 4 centimeters (40 small divisions or 8 large divisions).

4. Turn the **PACER OUTPUT** control to 0 mA.

There should be no *CHECK PADS* or *POOR PAD CONTACT* messages.

5. Disconnect the OneStep cable from the test port or OneStep electrodes, and slowly turn the **PACER OUTPUT** control to 16 mA or more.

The messages *CHECK PADS* and *POOR PAD CONTACT* appear alternately. The pace alarm sounds, and the **Clear Pace Alarm** softkey flashes.

6. Reconnect the OneStep cable, and press the **Clear Pace Alarm** softkey.

The messages *CHECK PADS* and *POOR PAD CONTACT* disappear, and the alarm tone stops.

## Recorder Check

1. Check the printer for an adequate supply of paper, then press the **RECORDER** button.
2. Press and hold the **SIZE** button for at least 2 seconds.

A calibration pulse of 1 mV appears on the display while the button is held. The amplitude of the calibration pulse is independent of the **SIZE** setting.

3. Inspect the recorder waveform for uniformity and darkness.
4. Inspect for uniformity of annotated characters and completeness of words.
5. Check the printer speed by verifying that the resulting waveform is:
  - 2.5 mm  $\pm$ 0.5 mm wide
  - 10 mm  $\pm$ 1.0 mm high

## Code Readiness Log

Each automatic and manual defibrillation test result is stored in internal non-volatile memory, the Code Log. A total of 1000 Code Readiness test records can be stored in internal memory. When the Code Readiness Log is full, the oldest records are erased on a first-in-first-out (FIFO) basis.

The Code Readiness Log can be transferred to an external computing device (see “Transferring Files to an External Device” on page 11-1).

If configured, the R Series prints a Code Readiness Test Report following the completion of each automatic defibrillator test.

To print the Code Readiness Log:

1. In **MONITOR** mode, press the **Report Data** softkey, then the **Test Log** softkey.  
A menu appears with the print options.
2. To print a specific test, use the **Prev Test** and **Next Test** softkeys to select the test, then press **Print Test**, or press **Print Test Log** to print the log of all of the tests.

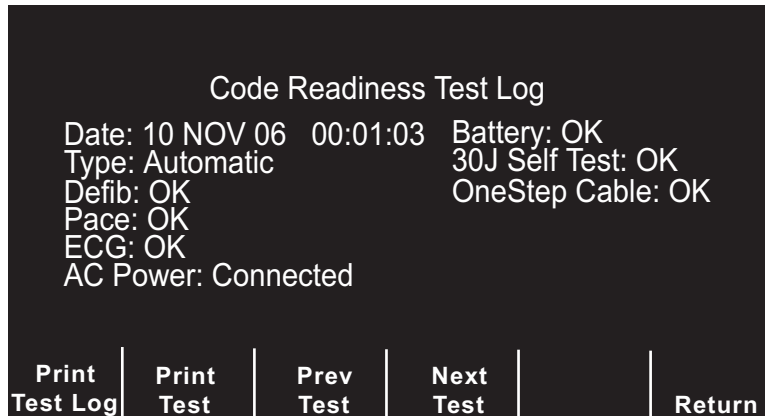


Figure 12-1. Code Readiness Test Log Print Display

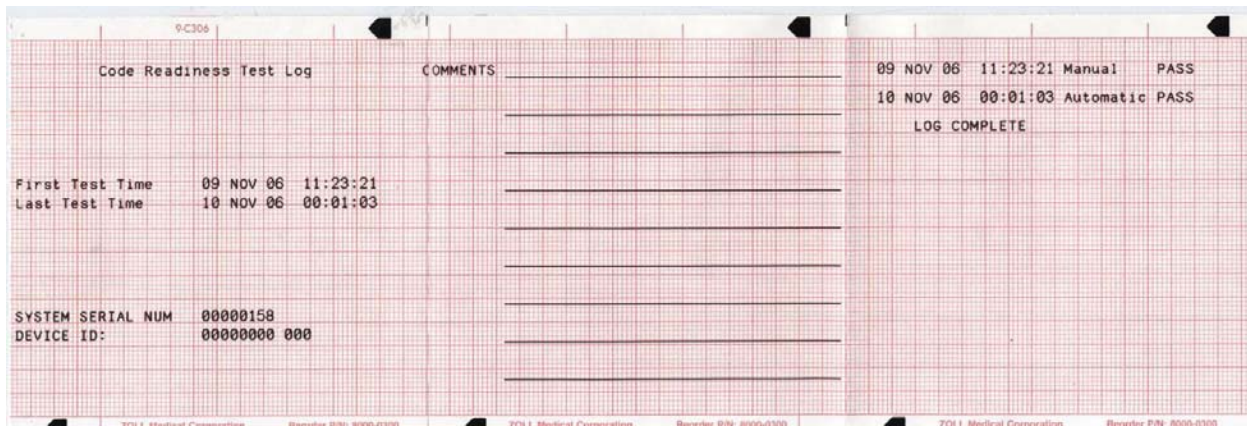


Figure 12-2. Code Readiness Test Log

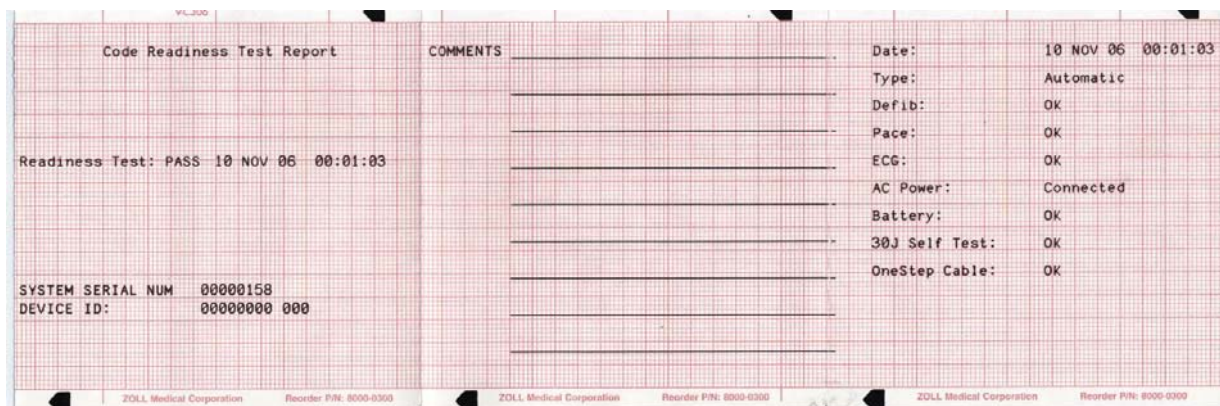


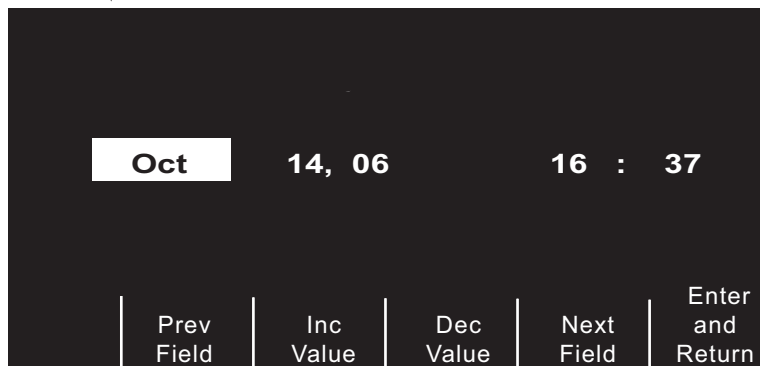
Figure 12-3. Code Readiness Test Report

## Setting Time and Date

To set the unit's time and date:

1. Set the Mode Selector to **MONITOR**.
2. Press the **Options** softkey.
3. Press **More**.
4. Press **Set Clock**.

The month field will be highlighted.



**Figure 12-4. Set Time Screen**

5. Press the **Inc Value** or **Dec Value** softkeys to select the appropriate month.
6. Press the **Next Field** softkey to set the selected month, and move the highlight to the next field (day).
7. Repeat steps 5 and 6 to set the correct day, year, hours, and minutes values.

**Note:** The last field does not automatically scroll (wrap) to the beginning. You must press the **Prev Field** softkey to enter the values for the previous field. If you need to make corrections, press the **Prev Field** softkey to move the highlight to the field previously entered.

8. Press the **Enter and Return** softkey to set all values and return to normal monitoring mode.

**Note:** The R Series unit may be configured to synchronize the time automatically with a data server in the Wi-Fi Data Transfer configuration settings. See the *R Series Configuration Guide* for more information.

## Cleaning the R Series Unit

R Series products and accessories are chemically resistant to most common cleaning solutions and noncaustic detergents. The following cleaning solutions are approved:

- 90% isopropyl alcohol (except on adapters, patient cable and Wi-Fi Data COMM Card)
- Soap and water
- Chlorine bleach solution of 30 milliliters per liter of water (except on Sync In/Marker Out connector, battery compartment pins and Wi-Fi cards)

ZOLL recommends cleaning the device, paddles, and cables with a soft damp cloth using the approved cleaning agents. The external printer parts should be cleaned with a damp, soft cloth only.

Do not immerse any part of the defibrillator (or its accessories) in water. Do not use ketones (such as acetone or MEK) on the defibrillator. Do not sterilize the defibrillator. Avoid using abrasives (including paper towels) on the display window.

Take special care to clean the defibrillation paddles after each use. The buildup of gel can interfere with ECG monitoring through the paddles, can adversely effect energy delivery and may reduce operator safety. Keep the paddle handles clean as well.

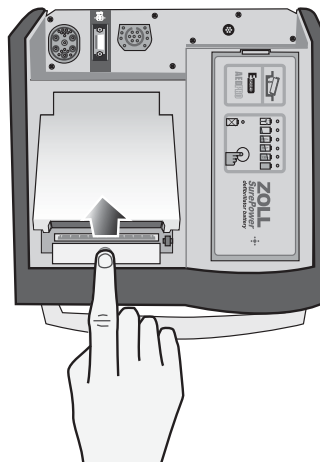
## Loading Stripchart Paper

The unit displays the message *CHECK RECORDER* when the printer is activated without paper or if the supply runs out during printing.

Use ZOLL stripchart paper (Part number 8000-0300).

To load paper into the stripchart printer:

1. Press the release button and allow the printer door to open, then remove any paper.

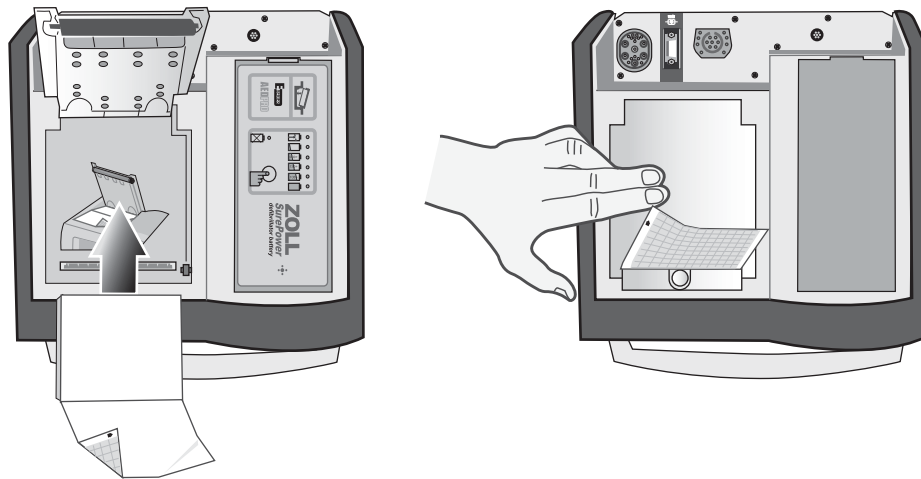


**Figure 12-5. Opening the Printer Door**

2. Refer to the illustration inside of the paper compartment for proper paper orientation, and place a new pad of stripchart paper in the tray.

**Note:** Paper feeds from the top of the stack with gridlines facing down.

3. Pull enough paper off the pad so that paper extends out of the unit when the printer cover is closed.
4. Close the printer cover by pressing down lightly on the edge of the cover next to the release button. Be sure the cover is flush with the top of the device.



**Figure 12-6. Inserting the Paper and Closing Printer Door**

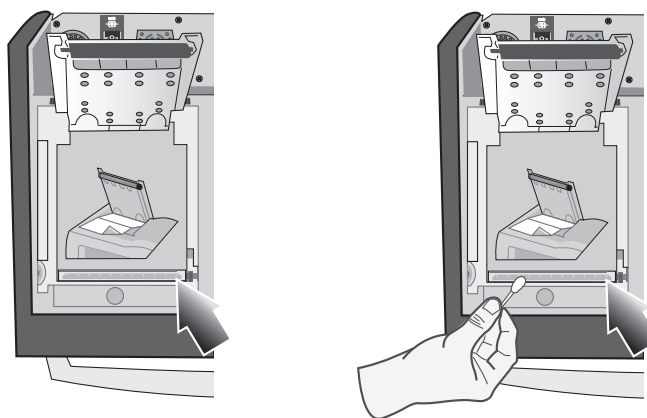
After the paper is loaded, press the **RECORDER** button to resume printing.

**Note:** To ensure you have loaded the paper properly, check to make sure the arrows printed on the red, grid side of the paper point upward.

## Cleaning the Print Head

To clean the recorder print head, perform the following steps:

1. Press the release button, and allow the printer door to open (see Figure 12-5); then remove any paper.
2. Locate the printhead along the front floor of the printer compartment, just below the release button.
3. Gently wipe the printhead with a cotton swab moistened with isopropyl alcohol, and dry any residual alcohol with another dry cotton swab.



**Figure 12-7. Cleaning the Print Head**

4. Place the paper back into the unit and close the cover (see Figure 12-6).



# Operator's Checklist for R Series Product

Recommended checks and procedures to be performed daily or weekly, depending on Automatic Test configuration.

Date \_\_\_\_\_

Location \_\_\_\_\_

Unit Serial Number \_\_\_\_\_

1. Condition	Remarks
Unit clean, no spills, clear of objects on top, case intact	
<b>2. Hands-free Therapy electrodes</b>	
1 set preconnected / 1 spare	
<b>3. Paddles</b>	
Paddles clean, not pitted	
Release from housing easily	
<b>4. Inspect cables for cracks, broken wires, connector</b>	
A ECG electrode cable, connector	
B Defibrillator paddle cables	
C OneStep cable, connector	
D Other patient cables	
<b>5. Batteries/External power supply</b>	
A Fully charged battery in unit	
B Fully charged spare battery available, or ready access to local AC mains	
<b>6. Disposable supplies</b>	
A Defib gel or gel patches	
B Hands-free therapy electrodes in <b>sealed</b> packages — 2 sets	
C ECG electrodes	
D Recorder paper	
E Alcohol wipes	
F Razors	
<b>7. Operational checks</b>	
<b>A Power On Sequence</b>	
Turn unit to MONITOR, 4-beep tone heard	
"MONITOR" message on display	
ECG size X 1	
"PADDLES" or "PADS" as lead selected	
<b>B Paddles</b>	
Paddles in holder: Set defib energy level to 30 joules, press paddles firmly into the side wells, and simultaneously press and hold both defib discharge buttons; "30J TEST OK" message on Recorder.	
<b>C Defibrillator</b>	
OneStep cable connected to test connector, or OneStep electrodes. Set defib energy level to 30 joules, press <b>SHOCK</b> button; "30J TEST OK" message on Recorder	
<b>D Pacer Operation (If installed)</b>	
OneStep cable not connected to Test Connector or OneStep electrodes	
Turn to PACER, set pacer rate to 150 ppm, press <b>RECORDER</b> button	
Pacer pulses occur over 2 large divisions (10 small divisions)	
Press <b>4:1</b> button, pulses occur every 8 large divisions	
Set PACER OUTPUT to 0 mA, no <i>CHECK PADS</i> message	
Set PACER OUTPUT to 16 mA, <i>CHECK PADS</i> message and alarm	
Reconnect OneStep cable to test connector, or OneStep electrodes. Press <b>Clear Pace Alarm</b> softkey; <i>CHECK PADS</i> message disappears and Pace alarm stops.	
<b>E Recorder</b>	
Press <b>RECORDER</b> button; Recorder runs. Press again; Recorder stops.	
Inspect Recorder printing	
<b>8. Please check the appropriate box after each use of this checklist.</b>	<b>Signature</b>
No action required	_____
Minor problem(s) corrected	
Disposable supplies replaced	
Major problem(s) identified — UNIT OUT OF SERVICE	

(This page intentionally left blank.)

# Chapter 13

## Troubleshooting

---

The troubleshooting information provided in this chapter is intended for use by nontechnical medical personnel during device operation. This chapter answers many of the common problems or questions that may arise during operation.

If trouble persists after consulting this guide, contact the appropriate technical personnel or ZOLL Technical Service Department. Refer to the *R Series Service Manual* for more detailed troubleshooting information.

### Code-Ready

Symptom	Recommended Action
1. Code Readiness indicator displays a red "X" while unit is turned off.	Turn the unit on. Print Code Readiness log as described on page 12-6. Follow messages and prompts to resolve the problem.
2. Code Readiness indicator displays a red "X" while unit is powered on.	Turn the unit off and then on again. Follow messages and prompts to resolve the problem.  Perform a Manual Defibrillator test as described in "Manual Defibrillator Testing" on page 12-3.  If the unit continues to fail, take it out of service and contact ZOLL Technical Service.

Symptom	Recommended Action
3. Pad Expired; Replace Pads	Check the expiration date on OneStep electrodes, and replace them if they are expired.
4. Poor Pad Condition; Replace Pads	OneStep electrode condition sensor indicates that the electrode gel has dried or aged beyond its specifications. The electrodes may no longer provide optimal therapy. Replace therapy electrodes. (If emergency defibrillation is required and spare hands-free therapy electrodes or paddles are not immediately available, it may be advisable to use the pads in question rather than delay therapy.)

## Monitor


Symptom	Recommended Action
1. Unit does not turn on or unexpectedly shuts off.	<ul style="list-style-type: none"> <li>• Check that battery pack is properly installed.</li> <li>• Verify the unit is plugged into AC power.</li> <li>• Replace battery pack with a fully charged battery pack.</li> </ul>
2. <i>X FAULT XX</i> message	<ul style="list-style-type: none"> <li>• A fault has been detected.</li> <li>• Attempt to clear the <i>X FAULT XX</i> message by turning the Mode Selector to <b>OFF</b> for more than 10 seconds, then back to the desired operating mode.</li> </ul> <p><b>Note:</b> Some settings (e.g. alarm settings, lead selection, ECG size) may need to be restored.</p>
3. <i>SET CLOCK</i> message	<ul style="list-style-type: none"> <li>• Set time and date information.</li> <li>• Verify that the internal lithium battery has been replaced within the last 5 years. Contact ZOLL Technical Service Department for assistance</li> </ul>
4. <i>ECG LEAD OFF</i> message	<ul style="list-style-type: none"> <li>• Check that ECG cable or OneStep Pacing cable is connected to patient and instrument.</li> <li>• Check that ECG electrodes or OneStep Pacing or Complete electrodes are making good contact and are not dried out.</li> <li>• If changing from 5-lead ECG patient cable to 3-lead ECG patient cable, remove the 5 lead cable then turn unit <b>OFF</b> for at least 10 seconds.</li> <li>• Replace ECG cable or OneStep cable.</li> </ul>
5. <i>POOR LEAD CONTACT</i> message	<ul style="list-style-type: none"> <li>• Check that ECG cable or OneStep Pacing cable is connected to patient and instrument.</li> <li>• Check that ECG electrodes or OneStep Pacing or Complete electrodes are making good contact and are not dried out.</li> <li>• If changing from 5-lead ECG patient cable to 3-lead ECG patient cable, remove the 5 lead cable then turn unit <b>OFF</b> for at least 10 seconds.</li> <li>• Replace ECG cable or OneStep cable.</li> </ul>

Symptom	Recommended Action
6. Noisy ECG, artifact, wandering baseline	<ul style="list-style-type: none"> <li>Consider 1 – 21Hz filter bandwidth (see <i>R Series Configuration Manual</i>).</li> <li>Prepare the patient's skin prior to electrode attachment.</li> <li>Check for proper adhesion of electrodes to patient.</li> <li>Reduce or eliminate ECG artifact due to electrode or patient cable movement. Route cables so that they don't pull on electrodes or swing excessively.</li> <li>Ensure patient is motionless.</li> <li>Check for possible excessive radio frequency interference.</li> </ul>
7. Poor ECG signal amplitude, calibration pulse normal	<ul style="list-style-type: none"> <li>Select another lead.</li> <li>Apply new electrodes using different placement.</li> </ul>
8. Inconsistent QRS beep or heart rate	<ul style="list-style-type: none"> <li>Select another lead.</li> <li>Alter ECG electrode placement.</li> </ul>
9. Sync marker is absent or inconsistent with QRS waveform on display and recorder	<ul style="list-style-type: none"> <li>Ensure device is in Sync mode.</li> <li>Ensure that device is NOT in Remote Sync mode.</li> <li>Change ECG lead selection.</li> <li>Alter ECG electrode placement.</li> <li>Paper too narrow. It should be 90 mm wide.</li> </ul>
10. No ECG trace or dashed line on display	<ul style="list-style-type: none"> <li>Device is in Remote Sync mode. Press the <b>Sync On/Off</b> softkey to exit Remote Sync mode.</li> </ul>

## Recorder

Symptom	Recommended Action
1. <i>CHECK RECORDER</i> message	<ul style="list-style-type: none"> <li>Recorder out of paper.</li> <li>Remove paper, check paper type, check recorder for paper jam, and reload paper.</li> <li>Recorder door is open.</li> <li>Paper is loaded upside down.</li> </ul>
2. Recorder makes stuttering sound when activated.	<ul style="list-style-type: none"> <li>Check recorder for paper jam.</li> </ul>
3. Light or poor quality printing	<ul style="list-style-type: none"> <li>Ensure correct paper is in use.</li> <li>Ensure paper is installed grid side against recorder print head.</li> <li>Recorder print head requires cleaning.</li> </ul>
4. Summary Report will not print when <b>Report/Print Chart</b> softkeys are activated.	<ul style="list-style-type: none"> <li>15 seconds have <b>not</b> elapsed since one of the events that trigger Summary Report to record have occurred. Wait 15 seconds, then try again.</li> </ul>

## Pacer

Symptom	Recommended Action
1. <i>CHECK PADS</i> message	<ul style="list-style-type: none"> <li>• Ensure therapy electrodes are connected to the OneStep cable.</li> <li>• Ensure electrode gel is not dry. Replace therapy electrodes if necessary.</li> <li>• Ensure good electrode-to-patient contact.</li> <li>• Check integrity of OneStep cable by plugging into test connector. <i>CHECK PADS</i> should disappear.</li> <li>• Ensure electrosurgical apparatus is not active.</li> </ul>
2. No stimulus marker (  ) is present on the ECG trace.	<ul style="list-style-type: none"> <li>• Ensure unit is in <b>PACER</b> mode.</li> <li>• Ensure <b>PACER RATE</b> (ppm) is set greater than patient heart rate.</li> </ul>
3. No ventricular capture beat appears after stimulus marker on ECG display.	<ul style="list-style-type: none"> <li>• Check patient's pulse.</li> <li>• Increase output current.</li> <li>• Ensure therapy electrodes are making good contact with the patient.</li> <li>• Select different ECG Lead configuration.</li> <li>• Review therapy electrode placement.</li> </ul>
4. Patient on "Standby" pacing gets paced intermittently.	<ul style="list-style-type: none"> <li>• Ensure proper ECG electrode or OneStep Pacing/Complete electrode connection and placement. If ECG lead wire comes off, pacer will automatically pace asynchronously.</li> <li>• Check ECG cable for damage.</li> <li>• Patient R-to-R interval varying. Pace rate close to patient's heart rate.</li> <li>• Verify rate is set appropriately.</li> </ul>
5. Heart rate display reads 0 with proper pacing capture displayed on ECG trace.	<ul style="list-style-type: none"> <li>• Check patient's pulse.</li> <li>• Select different ECG Lead configuration.</li> </ul>
6. Bedside/Central Station/Telemetry ECG display becomes erratic when pacing.	None, the patient monitor ECG inputs are overloaded by pacer signals. ECG can only be monitored by the R Series or pacing device while pacing.

## Defibrillator

Symptom	Recommended Action
1. Excessive artifact detected when using paddles as ECG source.	<ul style="list-style-type: none"> <li>• Ensure "PADDLES" is selected.</li> <li>• Firmly press paddles against patient skin.</li> <li>• Use gel on paddles.</li> <li>• Clean paddle surface.</li> <li>• Check and clean between adult and pediatric plate.</li> <li>• Check cable for damage.</li> <li>• Use ECG electrodes.</li> </ul>
2. Defibrillator will not charge (energy level does not increment on display).	<ul style="list-style-type: none"> <li>• Ensure that <b>SHOCK</b> button(s) on paddles or front panel are not stuck on.</li> <li>• Replace the battery pack.</li> </ul>
3. Charge time to 200 J exceeds 10 seconds.	<ul style="list-style-type: none"> <li>• Typical in a low battery condition (up to 20 seconds)</li> <li>• Plug device into AC power.</li> <li>• Install fully charged battery pack.</li> </ul>
4. Energy does not discharge when the <b>SHOCK</b> button(s) is pressed.	<ul style="list-style-type: none"> <li>• 60 seconds have elapsed in manual mode since initial charge ready. Energy was internally discharged.</li> <li>• Device is in Sync mode or Remote Sync mode and no QRS complex is detected.</li> <li>• Energy internally discharged because energy selection was changed during charge or after the device was ready.</li> <li>• Unit was not completely charged when <b>SHOCK</b> button(s) were pressed. Wait for <i>DEFIB XXXJ READY</i> message and ready tone.</li> <li>• Press and hold <b>SHOCK</b> button(s) until energy is delivered to the patient.</li> <li>• Pads or paddles not making good contact with patient.</li> </ul>
5. Unable to <b>SHOCK</b> when in Sync mode	<ul style="list-style-type: none"> <li>• Ensure <i>SYNC XXXJ SEL</i> is displayed on monitor.</li> <li>• Make sure ECG signals are displayed.</li> <li>• Check for Sync markers (arrow above R wave). If not present, change lead selection, or electrode placement.</li> <li>• Press and hold <b>SHOCK</b> button(s) until energy is delivered to the patient.</li> <li>• Alter ECG electrode placement.</li> </ul>

Symptom	Recommended Action
6. Unable to <b>SHOCK</b> when in Remote Sync mode	<ul style="list-style-type: none"> <li>• Ensure <i>REMOTE SYNC</i> is displayed in place of the ECG waveform and that <i>REMOTE SYNC XXXJ SEL.</i> is displayed.</li> <li>• Ensure that a remote device conforming with the Sync In/Marker Out specifications in Appendix A is properly connected.</li> <li>• Ensure that Sync markers appear with each R-wave on the remote device's display. If Sync markers are not present on the remote device's display or do not appear to be nearly simultaneous with each R-wave, do not proceed with synchronized cardioversion.</li> <li>• Press and hold <b>SHOCK</b> button(s) until energy is delivered to the patient.</li> </ul>
7. No apparent energy delivery to patient	<ul style="list-style-type: none"> <li>• Under certain circumstances, some patients will not show a physical reaction when energy is delivered.</li> <li>• Perform defibrillator self-test.</li> <li>• Check for <i>CHECK PADS</i> and <i>POOR PAD CONTACT</i> messages alternating on the monitor.</li> <li>• If hands-free therapy electrodes are used, ensure proper placement and contact.</li> <li>• Review the discharge stripchart for Joules/current delivered.</li> </ul>
8. <i>CHECK PADS</i> or <i>ATTACH PADS</i> message	<ul style="list-style-type: none"> <li>• Verify proper OneStep cable / hands-free therapy electrode connection by disconnecting and reconnecting the OneStep cable and hands-free therapy electrodes.</li> <li>• Ensure proper contact of hands-free therapy electrodes and that the patient does not have excessive hair beneath the electrodes.</li> <li>• OneStep cable is defective. If message persists, disconnect OneStep cable from therapy pads, and plug cable into test connector. <i>CHECK PADS</i> or <i>ATTACH PADS</i> should change to <i>DEFIB PAD SHORT</i> (Manual mode only).</li> <li>• Try using paddles to defibrillate.</li> <li>• Ensure electrosurgical apparatus is not active.</li> </ul>
9. <i>SELECT PADS</i> message	<ul style="list-style-type: none"> <li>• ECG Analysis will operate only when hands-free therapy electrodes are attached to the patient.</li> <li>• Disconnect paddle, and connect hands-free therapy electrodes for use in Advisory defibrillation.</li> <li>• Activate manual mode to use Paddles.</li> </ul>
10. <i>NOISY ECG</i> <i>RETRY ANALYSIS</i> message	<ul style="list-style-type: none"> <li>• Check for proper application and adhesion of hands-free therapy electrodes.</li> <li>• Check to make sure that nobody is touching the patient and that the patient is motionless.</li> </ul>



Symptom	Recommended Action
11. No 30J <i>TEST OK</i> message is displayed when performing a manual defibrillator self-test.	<ul style="list-style-type: none"> <li>• Check to make sure unit is set to 30 joules.</li> <li>• If testing with OneStep electrodes, make sure that the OneStep cable patient connector is firmly inserted into the electrode connector. Ensure the OneStep electrode package is sealed.</li> <li>• If testing with the Test Port, make sure the OneStep cable is firmly inserted into the Test Port.</li> <li>• If testing with paddles, make sure to press the paddles firmly into the paddle wells while discharging.</li> </ul>
12. <i>DEFIB MAINT. REQ.</i> message	<ul style="list-style-type: none"> <li>• Contact ZOLL Technical Service Department.</li> </ul>

## AC Charger

Symptom	Recommended Action
1. The Battery indicator is alternately illuminating green and yellow.	<ul style="list-style-type: none"> <li>• Verify battery is installed.</li> <li>• Turn unit <b>ON</b> to identify the fault condition.</li> <li>• Replace battery pack with a fully charged battery pack.</li> <li>• If problem persists, replace battery pack, unplug device from AC mains for more than 10 seconds and plug device back into AC mains.</li> </ul>
2. <i>LOW BATTERY</i> message appears on monitor when unit is plugged into AC mains.	<ul style="list-style-type: none"> <li>• Verify that the AC Power Indicator is illuminated.</li> <li>• If not, check AC power cord connection at the wall outlet and at the rear of the device.</li> <li>• Replace battery pack with a fully charged battery pack.</li> <li>• Unplug device from AC mains, and plug device back into AC mains.</li> <li>• Verify AC mains is working properly.</li> </ul>
3. Neither the Battery, nor AC Power indicator is illuminated when the device is plugged into AC mains.	<ul style="list-style-type: none"> <li>• Unplug device from AC mains, and plug device back into AC mains.</li> <li>• Verify AC mains is working properly.</li> </ul>

## CPR

<i>CHECK CPR PUCK</i> message is displayed.	<ul style="list-style-type: none"> <li>• No action is required. This is an informational message to indicate that default calibration values are being used for the CPR puck. The CPR values will be within the specification.</li> </ul>
---	---

(This page intentionally left blank.)

# Appendix A

# Specifications

---

This section describes the specifications for the R Series Defibrillator as well as the ECG rhythm analysis algorithm.

- “Defibrillator Specifications” on page A-2
- “Battery Pack Specifications” on page A-7
- “IEC 60601-1-2 Specifications” on page A-7
- “R Series Rectilinear Biphasic Waveform Characteristics” on page A-11
- “Clinical Trial Results for the Biphasic Waveform” on page A-23
- “ECG Rhythm Analysis Algorithm Accuracy” on page A-28

## Defibrillator Specifications

<b>General</b>	
Size (height • width • length)	8.2 in. • 10.5 in. • 12.5 in. with handle or 10.0 in. without handle 20.8 cm • 26.7 cm • 31.7 cm with handle or 25.4 cm without handle
Weight	13.6 lb (6.17 kg) with OneStep cable and battery pack 15.2 lb (6.89 kg) with paddles
Power (for R Series ALS, BLS and Plus models)	Battery: Rechargeable lithium ion battery pack  AC Power Requirements: 100-120 Vrms, 50/60 Hz 220-240 Vrms, 50 Hz AC Power Consumption: 275 VA maximum
Device classification	Class I and internally powered per EN 60601-1.
Design standards	Meets or exceeds applicable requirements of: IEC 60601-1: 2005 + CORR. 1 (2006) + CORR. 2 (2007) IEC 60601-2-4: 2010 (Third Edition) EN 61000-4-6, EN 61000-4-8, and EN 61000-4-11 as pertains to EN 60601-1-2. IEC 60601-2-27: 2011 (Third Edition) IEC 60601-2-49 (Second Edition): 2011 ISO 80601-2-55:2011 (First Edition) for use with IEC 60601-1: 2005 (Third Edition) + CORR.1 (2005) + CORR. 2 (2007) ISO 80601-2-61:2011 (First Edition) for use with IEC 60601-1: 2005 (Third Edition) + CORR.1 (2005) + CORR. 2 (2007)
Patient safety	All patient connections are electrically isolated.
<b>Environmental</b>	
Operating temperature	0°C to 40°C (32°F to 104°F)
Storage and shipping temperature	-20°C to 60°C (-4°F to 140°F)
Humidity	5% to 95% relative humidity, noncondensing
Vibration	IEC 68-2-6 and IEC 68-2-34
Shock	IEC 68-2-27, 50 g 6ms half sine
Operating pressure	594 to 1060 millibars (-1253 to 14046 ft.)
Particle and water ingress	IEC 529, IP 22
Electromagnetic compatibility (EMC)	CISPR 11 Class B - radiated and conducted emissions
Electromagnetic immunity	AAMI DF80; EN 61000-4-3 to 10 V/m
Electrostatic discharge	AAMI DF80; EN 61000-4-2
Conducted susceptibility	EN 61000-4-4, 61000-4-5, 61000-4-6

Display	
Screen type	High-resolution, liquid crystal display (LCD)
Screen size	6.5 inches (16.5 cm) diagonally
Display format	Nonfade moving bar display.
Sweep speed	25 mm/s
Viewing time	5 seconds 4 seconds with certain monitoring parameter options
Messages	ERASING REPORT, INSERT CARD, REPLACE BATTERY, LOW BATTERY, PERFORM CPR, NOISY ECG, RETRY ANALYSIS, CHECK PATIENT, ANALYSIS HALTED, PRESS ANALYZE, NO SHOCK ADV., SHOCK ADVISED, PRESS CHARGE, SELECT PADS, SELECT ECG LEADS, SELECT DEFIB MODE, VF ALARMS OFF, REMOVE SYNC, CHECK PADS, ATTACH PADS, POOR PAD CONTACT, DEFIB PAD SHORT, PADDLE FAULT, ECG LEAD OFF, USE PADDLE DISCHG, CANNOT CHARGE, RELEASE SHOCK, PRESS SHOCK, 30J TEST OK, TEST FAILED, PACER DISABLED, DEFIB DISABLED, SET PACE MA, CHECK RECORDER, ANALYZING ECG, FULLY RELEASE
Electrodes	
Hands-free therapy electrodes	<ul style="list-style-type: none"> <li>• OneStep electrodes</li> <li>• Pro-padz</li> <li>• Stat-padz</li> <li>• Pediatric Pedi-padz®</li> </ul>
Defibrillator	
Waveform	Rectilinear Biphasic
Energy selection (delivered to a 50Ω load)	<ul style="list-style-type: none"> <li>• <b>ADULT:</b> 1, 2, 3, 4, 5, 6, 7 8, 9, 10, 15, 20, 30, 50, 75, 100, 120, 150, 200 joules (through front panel buttons or paddle buttons)</li> <li>• <b>PEDIATRIC:</b> 1, 2, 3, 4, 5, 6, 7 8, 9, 10, 15, 20, 30, 50, 70, 85, 100, 120, 150, 200 joules (through OneStep pediatric electrodes only)</li> </ul>
Charge Time	<ul style="list-style-type: none"> <li>• Less than 7 seconds with a new, fully charged battery (first 15 charges to 200 joules), with or without AC power at rated mains voltage.</li> <li>• For the fifteenth discharge at maximum energy, the charge time is less than 10 seconds, with or without AC power at rated mains voltage. Depleted batteries result in a longer defibrillator charge time.</li> <li>• Less than 15 seconds when operating without a battery, using AC power alone at 90% of the rated mains voltage.</li> <li>• Less than 25 seconds from the initial power on, with a new, fully charged battery pack (depleted by up to fifteen 200 Joule discharges) or when operating without a battery, using AC power alone at 90% or 100% of the rated mains voltage.</li> <li>• Less than 30 seconds from initial power on and after rhythm analysis (advisory mode) with a new, fully charged pack (depleted by up to fifteen 200 J discharges) and using AC power at 90% of rated mains voltage.</li> </ul>
Patient Impedance Range	15 - 300 ohms
Energy display	Screen shows selected and delivered energy.

Synchronized mode	Synchronizes defibrillator discharge to the patient's R wave. SYNC is indicated on the display with R wave markers above the ECG waveform on the screen and stripchart. When ECG is monitored by the device, meets the DF-80:2003 requirement of 60ms maximum time delay between the peak of the R wave and the delivery of energy.
Charge controls	<b>CHARGE</b> button on front panel and apex paddle.
Paddles	Standard apex/sternum paddles. Adult plate slides off to expose smaller plate for pediatric patients.
Automatic Defibrillator Test	Verifies defibrillator charging and discharging without removing paddles from storage wells or with OneStep cable connected to the Test Port or OneStep electrodes.
Defibrillation advisory	Evaluates electrode connection and patient ECG to determine if defibrillation is required.  Shockable rhythms: <ul style="list-style-type: none"> <li>Ventricular fibrillation (VF) with amplitude &gt; 100 <math>\mu</math>V</li> <li>Wide-complex ventricular tachycardia (VT) with rates greater than 150 beats per minute (adult), or 200 beats per minute (pediatric).</li> </ul> Refer to "ECG Rhythm Analysis Algorithm Accuracy" on page A-28 for sensitivity and specificity performance.
<b>CPR Monitoring</b>	
Compression depth	0.75 to 3 inches $\pm$ 0.25 inches 1.9 to 7.6 cm $\pm$ 0.6 cm
Compression rate	50 to 150 compressions per minute
<b>ECG Monitoring</b>	
Patient connection	3-lead cable, 5-lead cable, paddles, or hands-free therapy electrodes
Input protection	Fully defibrillator-proof. Special circuitry prevents distortion of ECG during pacer pulse.
Implanted pacemaker spike display	Dedicated circuitry detects most implanted pacemaker spikes and provides standard display marker of spike on ECG trace.
Implanted Pulses Detected	$\pm$ 2 mV to $\pm$ 700mV amplitude, 0.1ms to 2ms width, with a recharge constant of 0 to 100ms.  <b>Note:</b> The pacemaker pulse rejection capability for the R Series with pacemaker pulses alone includes pulses between +/-2mV and +/-700mV amplitude, with widths between 0.1ms and 2ms and overshoot from 0 to 100ms.  The pacemaker pulse rejection capability for the R Series with pacemaker pulses and a normally paced QRS and T wave includes pulses between +/-2mV and +/-700mV amplitude, with widths between 0.1ms and 2ms and overshoot from 0 to 100ms.  The pacemaker pulse rejection capability for the R Series with pacemaker pulses with an ineffectively paced QRS pattern includes pulses between +/-2mV and +/-700mV amplitude, with widths between 0.1ms and 2ms and overshoot from 0 to 100ms.  The R Series is not capable of rejecting A-V Sequential pacemaker pulses.
Bandwidth	0.5 Hz to 21 Hz standard; 0.05 Hz to 150 Hz diagnostic 0.5 Hz to 40 Hz, and 1 Hz to 21 Hz as configurable options

Lead selection	I, II, III, aVR, aVL, aVF, V, PADS, PADDLES, INTL PADDLES P1, P2, P3 with OneStep Pacing electrodes
ECG size relative scale factor	x0.5, x1, x1.5, x2 or x3 Current value shown on display.
Heart rate range	30 to 300 beats per minute
Heart rate accuracy	±5%
Heart rate alarm	Screen icon indicates activated/deactivated status. User selectable.  Tachycardia: 60 to 280 beats per minute Bradycardia: 20 to 100 beats per minute
Tall T-wave Rejection	≤ 0.8 mV
Heart Rate Averaging	The R Series averages the interval between the last 6 detected beats. On startup, the R Series averages the rate between detected beats once two beats are detected, until a full 6 beats have been received. The rate is updated every beat. After this condition is met, the meter is updated every beat with an average of the last 6 beats.  If a period of time greater than 5 seconds elapses without a beat detected, the heart rate meter reports a rate of 0 bpm, which is repeated every 5 seconds.
Accuracy and Response Time to Irregular Rhythm	Averaging over 5 R-R intervals, per AAMI EC 13:2002: <ul style="list-style-type: none"> <li>• Ventricular bigeminy (Figure 3a) - 80.5 bpm</li> <li>• Slow alternating ventricular bigeminy (Figure 3b) - 60.5 bpm</li> <li>• Slow alternating ventricular bigeminy (Figure 3c) - 120.5 bpm</li> <li>• Bidirectional systoles (Figure 3d) - 93.3 bpm</li> </ul>
Response Time to Change in Heart Rate	<ul style="list-style-type: none"> <li>• 3 seconds maximum for a step increase from 80 bpm to 120 bpm</li> <li>• 6 seconds maximum for a step decrease from 80 bpm to 40 bpm</li> </ul>
Time to Alarm for Tachycardia	from NSR 80 to VT 195 at 1 mV: 4 seconds from NSR 80 to VT 195 at 2 mV: 4 seconds from NSR 80 to VT 195 at 4 mV: 4 seconds from NSR 80 to VT 206 at 0.5 mV: 4 seconds from NSR 80 to VT 206 at 1 mV: 4 seconds from NSR 80 to VT 206 at 2 mV: 4 seconds
Leads Off Sensing	A DC current of 0.04 uA per lead wire is supplied to the patient.
Active Noise Suppression	The sum of all leadwire currents is returned via the active noise suppression leadwire: <ul style="list-style-type: none"> <li>• 0.08 uA DC in 3 lead mode</li> <li>• 0.16 uA DC in 5 lead mode</li> </ul>
<b>Pacemaker option</b>	
Type	VVI demand; asynchronous (fixed rate) when used without ECG leads or in asynchronous (Async) pacing mode
Pulse type	Rectilinear, constant current
Pulse duration	40 ms ±2 ms
Pulse amplitude (output)	Variable 0 mA to 140 mA ±5% or 5 mA, whichever is greater Increments/decrements by a value of 2 mA
Pacing rate	30 to 180 pulses per minute (ppm) ±1.5% Increments/decrements by a value of 2 ppm
Output protection	Fully defibrillator-protected and isolated

<b>Recorder and Stripchart Printer</b>		
Paper	80 mm thermal (grid width) 90 mm (paper width)	
Speed	25 mm/s	
Delay	6 seconds	
Annotations	Time, date, defibrillation energy, heart rate, pacer output, QRS synchronization marker, ECG size, ECG lead, alarm, defibrillator test result, analyze ECG, diagnostic bandwidth  Messages: <i>ANALYSIS HALTED, NOISY ECG, SHOCK ADVISED, NO SHOCK ADV.</i>	
Printing method	High-resolution, thermal array print head	
Printout modes	Manual or automatic; user-configurable	
<b>Data card</b>		
Type	Compact flash card	
<b>Sync in / Marker out / ECG out</b>		
Sync In	0-5 V (TTL Level) pulse, active high, 5 to 15 msec in duration, no closer than 200 ms apart. Energy transfer begins within 25 ms of the leading edge of the external sync pulse.	<div style="text-align: center;"> <p><b>R Series Connector Pinout</b></p> </div> <p>SWITCHCRAFT CONXALL 17982-7SG-300 Mating Connector: SWITCHCRAFT CONXALL 16982-7PG-522</p>
Marker Out	0-5 V (TTL Level) pulse, active high, 10 ms in duration, the leading edge of the pulse occurs within 35 ms of the peak of the R-wave)	
ECG Out	1.0 V/cm of deflection on stripchart recorder  <25 ms delay from patient ECG input	
<b>Wi-Fi Card</b>		
ZOLL R Series Data COMM	Model: 802.11 abgn Wireless LAN Compact Flash Card	



## Battery Pack Specifications

Type	Rechargeable lithium ion
Weight	1.7 lb (0.77 kg)
Nominal voltage	10.6 V
Recharge time	4 hours or less within R Series.
Operating time	For a new, fully charged battery at 20°C: <ul style="list-style-type: none"> <li>• 100 defibrillator discharges at maximum energy (200 joules), or</li> <li>• 4 hours of continuous ECG monitoring, or</li> <li>• 3.5 hours of continuous ECG monitoring and pacing at 60 mA, 80 pulses per minute</li> </ul>
Low battery indicator	The message <i>LOW BATTERY</i> is displayed on the screen when there is approximately 15 minutes of ECG monitoring time left on the battery. Two-beep low battery tone sounds once a minute until just before shutdown when the unit beeps twice every 2 seconds.  The time from display of the message <i>LOW BATTERY</i> or <i>REPLACE BATTERY</i> until the defibrillator shuts down varies depending on the battery age and condition.
Battery Shelf Life	3 months before retest and recharge

## IEC 60601-1-2 Specifications

This section provides specification tables for the R Series as per IEC 60601-1-2.

## Electromagnetic Emissions Declaration

Guidance and manufacturer's declaration — electromagnetic emissions for the R Series.

Emissions test	Compliance	Electromagnetic environment – guidance
RF Emissions CISPR 11	Group 1	The R Series uses RF energy for its internal function only. Therefore, its RF emissions are very low and are not likely to cause any interference in nearby electronic equipment.
RF Emissions CISPR 11	Class B	The R Series is suitable for use in all establishments, including domestic establishments and those directly connected to the public low-voltage power supply network that supplies buildings used for domestic purposes.
Harmonic Emissions IEC 61000-3-2	Class A	
Voltage Fluctuations/ Flicker Emissions IEC 61000-3-3	Complies	
Medical electrical equipment requires special precautions regarding electromagnetic compatibility and must be installed and put into service in accordance with the EMC information provided in this document.		

## Electromagnetic Immunity Declaration (EID)

Guidance and manufacturer's declaration — electromagnetic immunity for the R Series.


The ZOLL R Series device is intended for use in the electromagnetic environment specified below. Operation outside of this environment could result in the misinterpretation of the ECG rhythms or CPR signals, interference to the display or audio messages, or the inability to provide defibrillation therapy. The operator of the unit must ensure that it is used in this environment.

The ZOLL R Series defibrillator's essential performance energy delivery (defibrillation, pacing, ECG rhythm analysis, ECG, CPR feedback, SpO<sub>2</sub>, EtCO<sub>2</sub> and NIBP) is clinically acceptable, and the R Series defibrillator meets basic safety when operated in the electromagnetic environment specified in the following table.

The R Series is intended for use in the electromagnetic environment specified below. Operation outside of this environment could result in the misinterpretation of the ECG rhythms or CPR signals, interference to the display or audio messages, or the inability to provide defibrillation therapy.			
Immunity test	IEC 60601 test level	Compliance level	Electromagnetic environment – guidance
Electrostatic discharge (ESD) IEC 61000-4-2	±6 kV contact ±8 kV air	±6 kV contact ±8 kV air	The relative humidity should be at least 30%.
Electrical fast transient/burst IEC 61000-4-4	±2 kV for power supply lines ±1 kV for input/output lines	±2 kV for power supply lines Not applicable	Mains power quality should be that of a typical commercial or hospital environment.
Surge IEC 61000-4-5	±1 kV differential mode ±2 kV common mode	±1 kV differential mode ±2 kV common mode	Mains power quality should be that of a typical commercial or hospital environment.
Voltage dips, short interruptions and voltage variations on power supply input lines IEC 61000-4-11	<5% $U_T$ (>95% dip in $U_T$ ) for 0.5 cycle 40% $U_T$ (60% dip in $U_T$ ) for 5 cycles 70% $U_T$ (30% dip in $U_T$ ) for 25 cycles <5% $U_T$ (>95% dip in $U_T$ ) for 5 seconds	<5% $U_T$ (>95% dip in $U_T$ ) for 0.5 cycle 40% $U_T$ (60% dip in $U_T$ ) for 5 cycles 70% $U_T$ (30% dip in $U_T$ ) for 25 cycles <5% $U_T$ (>95% dip in $U_T$ ) for 5 seconds	Mains power quality should be that of a typical commercial or hospital environment. If the user of the R Series requires continued operation during power mains interruptions, it is recommended that the R Series be powered by an uninterruptible power supply or a battery.
Power frequency (50/60 Hz) magnetic field IEC 61000-4-8	30 A/m	30 A/m	Power frequency magnetic fields should be at levels characteristic of typical location in a typical commercial or hospital environment.
NOTE 1: $U_T$ is the AC mains voltage prior to the application of the test level.			
NOTE 2: ESD discharges may cause screen flickers, brief screen black outs and in rare occasions a device reset.			
NOTE 3: The use of accessories and cables other than those specified in the accessories section of this document may result in increased emissions or decreased immunity of the R Series defibrillator.			
NOTE 4: Certain areas in the hospital environment may control the relative humidity below 30%. In such areas the risk of ESD discharges may be higher than the levels in the R Series tested specifications. Operators should be aware of these conditions and take appropriate action.			

## Electromagnetic Immunity

Guidance and manufacturer's declaration – electromagnetic immunity.

The functions of the R Series are intended for use in the electromagnetic environment specified below. Operation outside of this environment could result in the misinterpretation of the ECG rhythms or CPR signals, interference to the display or audio messages, or the inability to provide defibrillation therapy.			
Immunity test	IEC 60601 test level	Compliance level	Electromagnetic environment – guidance
Conducted RF IEC 61000-4-6	3 Vrms 150 kHz to 80 MHz outside ISM bands <sup>a</sup>	3 Vrms	Portable and mobile RF communications equipment should be used no closer to any part of the R Series, including cables, than the recommended separation distance calculated from the equation applicable to the frequency of the transmitter.  <b>Recommended separation distance</b>  $d = 1.2 \sqrt{P}$  $d = 1.2 \sqrt{P}$
	10 Vrms 150 kHz to 80 MHz in ISM bands <sup>a</sup>	10 Vrms	
	Radiated RF IEC 61000-4-3 (ECG monitoring from Leads & PADS)	10 V/m 80 MHz to 2.7 GHz	
Radiated RF IEC 61000-4-3 (EtCO <sub>2</sub> , SpO <sub>2</sub> , NIBP, and all other functions)	3 V/m 80 MHz to 2.7 GHz	3 V/m <sup>d</sup>	$d = 1.2 \sqrt{P}$ 80 MHz to 800 MHz $d = 2.3 \sqrt{P}$ 800 MHz to 2.7 GHz  where P is the maximum output power rating of the transmitter in watts according to the transmitter manufacturer and d is the recommended separation distance in meters. <sup>b</sup> Field strengths from fixed RF transmitters, as determined by electromagnetic site survey, <sup>c</sup> should be less than the compliance level in each frequency range. <sup>d</sup> Interference may occur in the vicinity of equipment marked with the following symbol:  
NOTE 1: At 80 MHz and 800 MHz, the higher frequency range applies.			
NOTE 2: These guidelines may not apply in all situations. Electromagnetic propagation is affected by absorption and reflection from structures, objects, and people.			

a. The ISM (industrial, scientific, and medical) bands between 150 kHz and 80 MHz are 6.765 MHz to 6.795 MHz; 13.553 MHz to 13.567 MHz; 26.957 MHz to 27.283 MHz; and 40.66 MHz to 40.70 MHz.

b. The compliance levels in the ISM frequency bands between 150 kHz and 80 MHz and in the frequency range 80 MHz to 2.7 GHz are intended to decrease the likelihood that mobile/portable communications equipment could cause interference if it is inadvertently brought into patient areas. For this reason, an additional factor of 10/3 is used in calculating the recommended separation distance for transmitters in these frequency ranges.

- c. Field strengths from fixed transmitters, such as base stations for radio (cellular/cordless) telephones and land mobile radios, amateur radio, AM and FM radio broadcast and TV broadcast cannot be predicted theoretically with accuracy. To assess the electromagnetic environment due to fixed RF transmitters, an electromagnetic site survey should be considered. If the measured field strength in the location in which the R Series is used exceeds the applicable RF compliance level above, the R Series should be observed to verify normal operation. If abnormal performance is observed, additional measures may be necessary, such as reorienting or relocating the R Series.
- d. Over the frequency ranges 150 kHz to 80 MHz field strength should be less than 10 V/m, as shown within the compliance column to the left.

## Recommended Separation Distances from RF Equipment for the R Series Functions

Recommended separation distances between portable and mobile RF communications equipment and the R Series.

The functions of the R Series are intended for use in the electromagnetic environment in which radiated RF disturbances are controlled. The customer or user of the R Series can help prevent electromagnetic interference by maintaining a minimum distance between portable and mobile RF communications equipment (transmitters) and the R Series as recommended below, according to the maximum output power of the communications equipment.				
Rated maximum output power of equipment (in watts)	Separation distance according to frequency of transmitter (in meters)			
	150 kHz to 80 MHz outside ISM bands	150 kHz to 80 MHz in ISM bands	80 MHz to 800 MHz	800 MHz to 2.7 GHz
	$d = 1.2 \sqrt{P}$	$d = 1.2 \sqrt{P}$	$d = 1.2 \sqrt{P}$	$d = 2.3 \sqrt{P}$
0.01	0.12	0.12	0.12	0.23
0.1	0.38	0.38	0.38	0.73
1	1.2	1.2	1.2	2.3
10	3.8	3.8	3.8	7.3
100	12	12	12	23
For transmitters rated at a maximum output power not listed above, the recommended separation distance $d$ in meters can be determined using the equation applicable to the frequency of the transmitter, where $P$ is the maximum output power rating of the transmitter in watts according to the transmitter manufacturer.				
NOTE 1: At 80 MHz and 800 MHz, the separation distance for the higher frequency range applies.				
NOTE 2: The ISM (industrial, scientific, and medical) bands between 150 kHz and 80 MHz are 6.765 MHz to 6.795 MHz; 13.553 MHz to 13.567 MHz; 26.957 MHz to 27.283 MHz; and 40.66 MHz to 40.70 MHz.				
NOTE 3: An additional factor of 10/3 is used in calculating the recommended separation distances for transmitters in the ISM frequency bands between 150 kHz and 80 MHz and in the frequency range 80 MHz to 2.7 GHz to decrease the likelihood that mobile/portable communications equipment could cause interference if it is inadvertently brought into patient areas.				
NOTE 4: These guidelines may not apply in all situations. Electromagnetic propagation is affected by absorption and reflection from structures, objects, and people.				

## R Series Rectilinear Biphasic Waveform Characteristics

Table A-1 shows the characteristics of the R Series Rectilinear Biphasic™ waveform when discharged into 25 ohm, 50 ohm, 100 ohm, 125 ohm, 150 ohm and 175 ohm loads at the maximum energy setting of 200 joules.

**Table A-1. R Series Rectilinear Biphasic Waveform Characteristics**

	200 J discharged into					
	25Ω	50Ω	100Ω	125Ω	150Ω	175Ω
<b>First phase</b>						
Maximum initial current	31.4 A	30.4 A	19.7 A	19.4 A	16.7 A	15.6 A
Average current	27.1 A	24.9 A	17.5 A	16.2 A	14.4 A	13.2 A
Duration	6 ms	6 ms	6 ms	6 ms	6 ms	6 ms
<b>Interphase duration</b> (between first and second phases)	200 μs	200 μs	200 μs	200 μs	200 μs	200 μs
<b>Second phase</b>						
Initial current	29.2 A	18.8 A	15.1 A	13.2 A	12.1 A	11 A
Average current	14.7 A	13 A	12.5 A	11.3 A	10.7 A	9.9 A
Duration	4 ms	4 ms	4 ms	4 ms	4 ms	4 ms

**Table A-2. Delivered Energy at Every Defibrillator Setting into a Range of Loads**

Selected Energy	Load							Accuracy
	25Ω	50Ω	75Ω	100Ω	125Ω	150Ω	175Ω	
1 J	1 J	1 J	1 J	1 J	1 J	1 J	1 J	±3 J
2 J	1 J	2 J	2 J	2 J	2 J	2 J	2 J	±3 J
3 J	2 J	3 J	3 J	3 J	3 J	3 J	3 J	±3 J
4 J	3 J	4 J	4 J	5 J	5 J	5 J	4 J	±3 J
5 J	3 J	5 J	6 J	6 J	6 J	6 J	6 J	±3 J
6 J	4 J	6 J	7 J	7 J	7 J	7 J	7 J	±3 J
7 J	5 J	7 J	8 J	8 J	8 J	8 J	8 J	±3 J
8 J	5 J	8 J	9 J	9 J	10 J	9 J	9 J	±3 J
9 J	6 J	9 J	10 J	11 J	11 J	11 J	10 J	±3 J
10 J	7 J	10 J	12 J	12 J	12 J	12 J	12 J	±3 J
15 J	10 J	16 J	17 J	18 J	18 J	18 J	17 J	±3 J
20 J	14 J	21 J	23 J	24 J	24 J	24 J	23 J	±15%
30 J	21 J	32 J	35 J	36 J	37 J	36 J	35 J	±15%
50 J	35 J	54 J	59 J	61 J	62 J	61 J	59 J	±15%
70 J	49 J	76 J	83 J	85 J	87 J	86 J	83 J	±15%
75 J	53 J	81 J	89 J	91 J	93 J	92 J	89 J	±15%
85 J	60 J	92 J	101 J	104 J	106 J	104 J	101 J	±15%
100 J	71 J	109 J	119 J	122 J	125 J	123 J	119 J	±15%
120 J	85 J	131 J	143 J	147 J	150 J	147 J	143 J	±15%

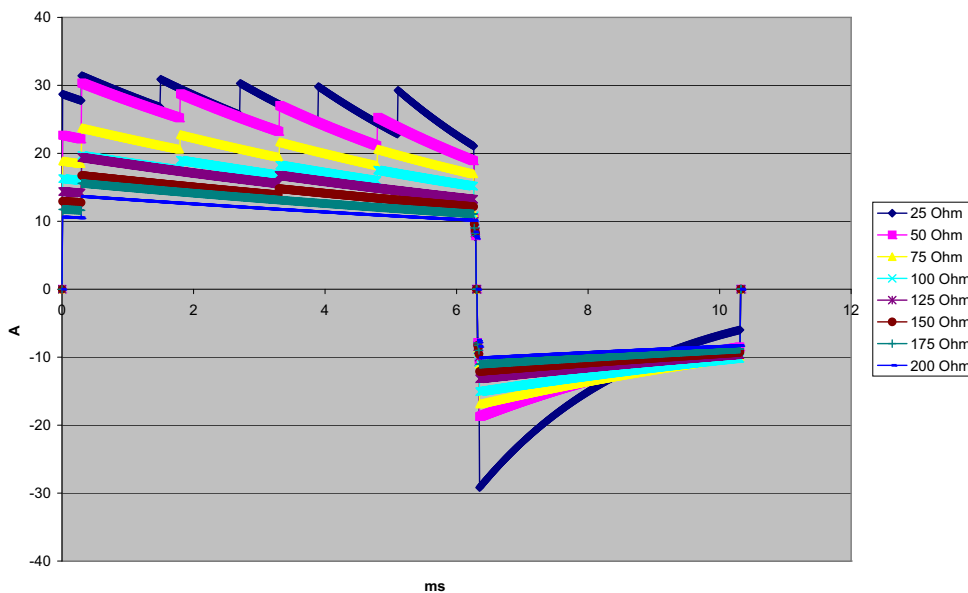
**Table A-2. Delivered Energy at Every Defibrillator Setting into a Range of Loads**

Selected Energy	Load							Accuracy
	25Ω	50Ω	75Ω	100Ω	125Ω	150Ω	175Ω	
150 J	107 J	164 J	180 J	183 J	188 J	184 J	179 J	±15%
200 J	142 J	230 J	249 J	253 J	269 J	261 J	260 J	±15%

The R Series Rectilinear Biphasic waveform employs the same first and second phase timing, similar first and second phase currents/voltages, and essentially the same mechanisms for controlling defibrillation waveshape as the ZOLL M Series<sup>®</sup> defibrillator. The M Series and R Series defibrillation waveforms are considered substantially equivalent.

Figures A-1 through A-21 show the Rectilinear Biphasic waveforms that are produced when the R Series defibrillator is discharged into loads of 25, 50, 75, 100, 125, 150, and 175 ohms at each energy setting.

The vertical axis shows the current in amperes (A); the horizontal axis shows the duration of time in milliseconds (ms).



**Figure A-1. Rectilinear Biphasic Waveform at 200 Joules**

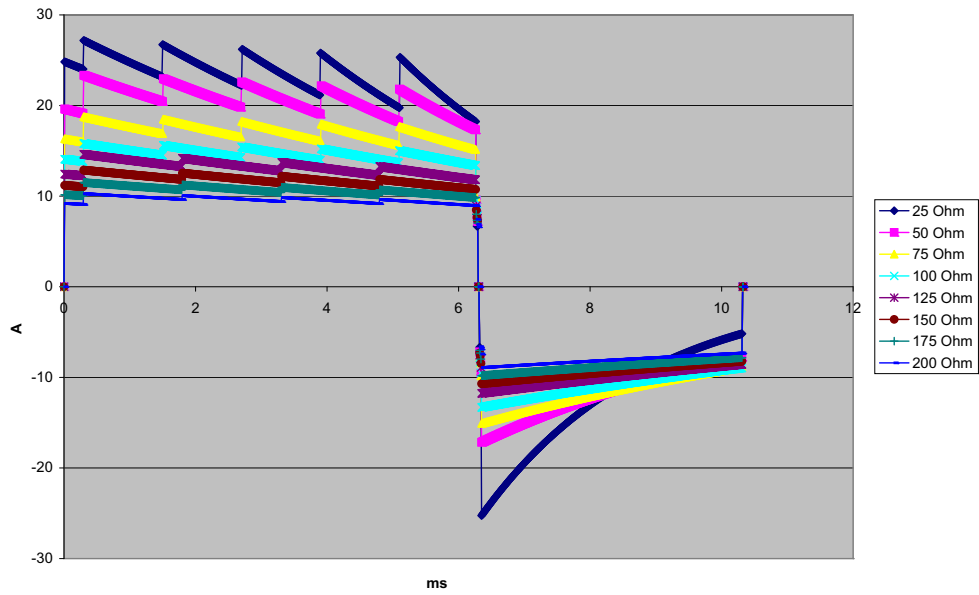


Figure A-2. Rectilinear Biphasic Waveform at 150 Joules

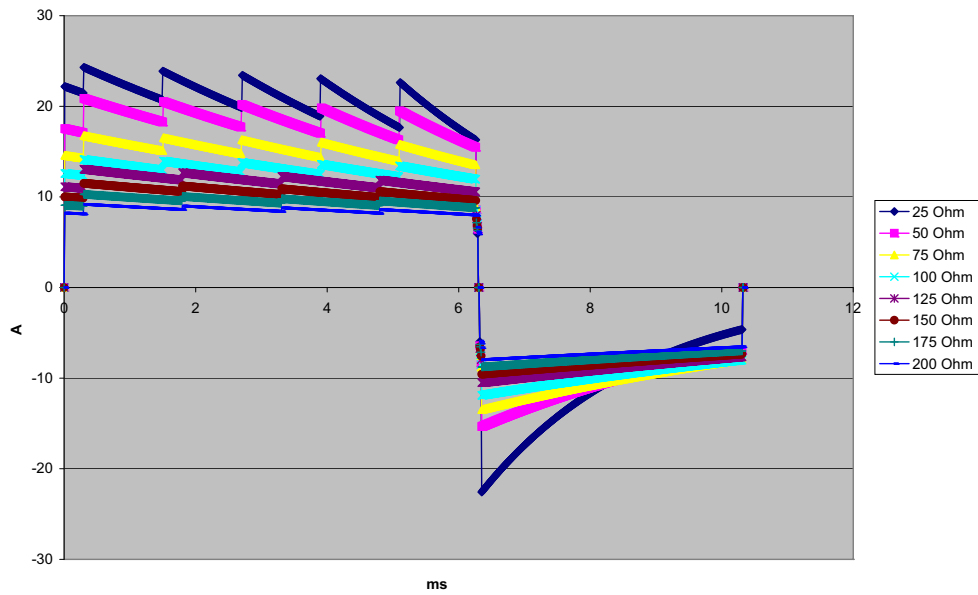


Figure A-3. Rectilinear Biphasic Waveform at 120 Joules

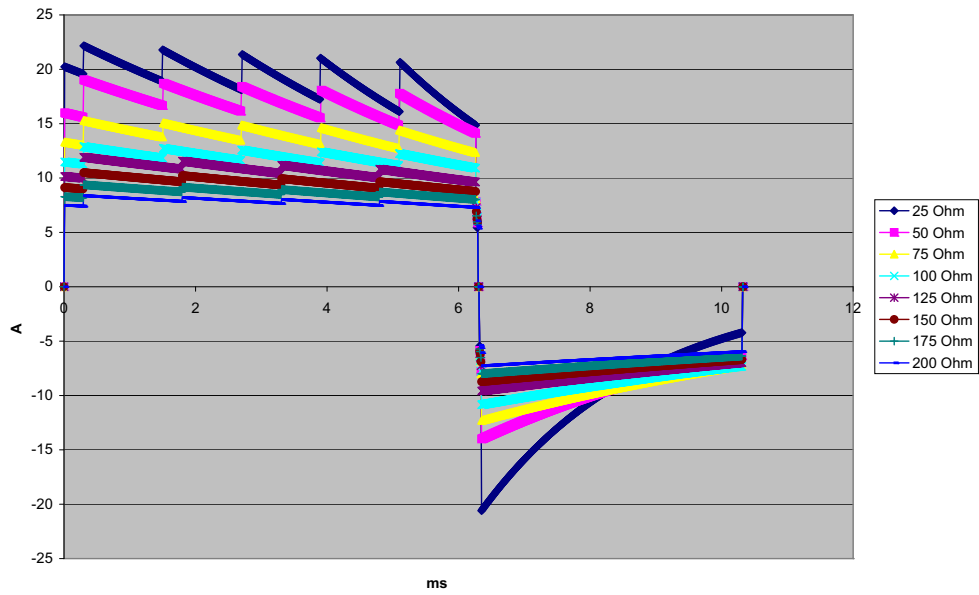


Figure A-4. Rectilinear Biphasic Waveform at 100 Joules

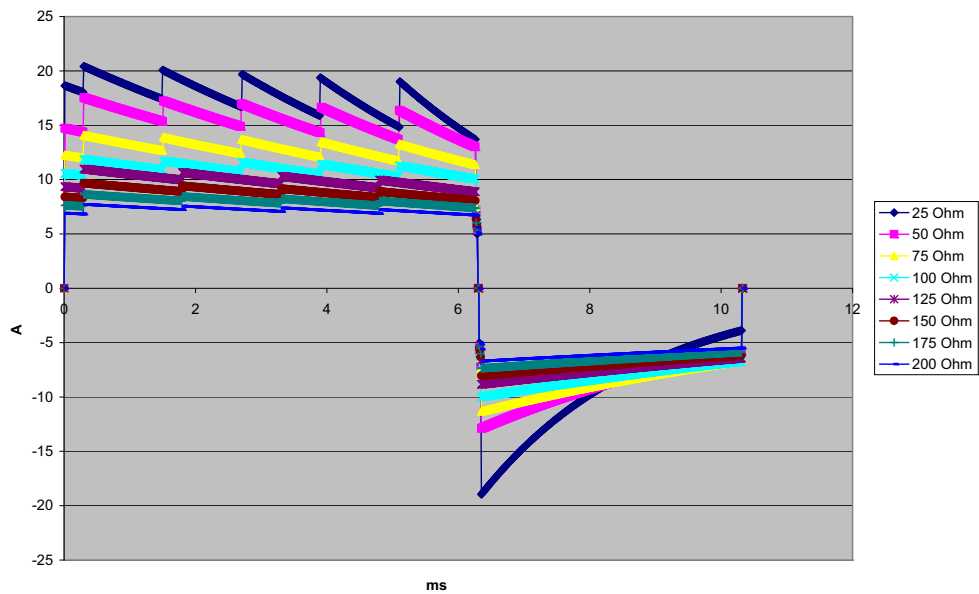


Figure A-5. Rectilinear Biphasic Waveform at 85 Joules



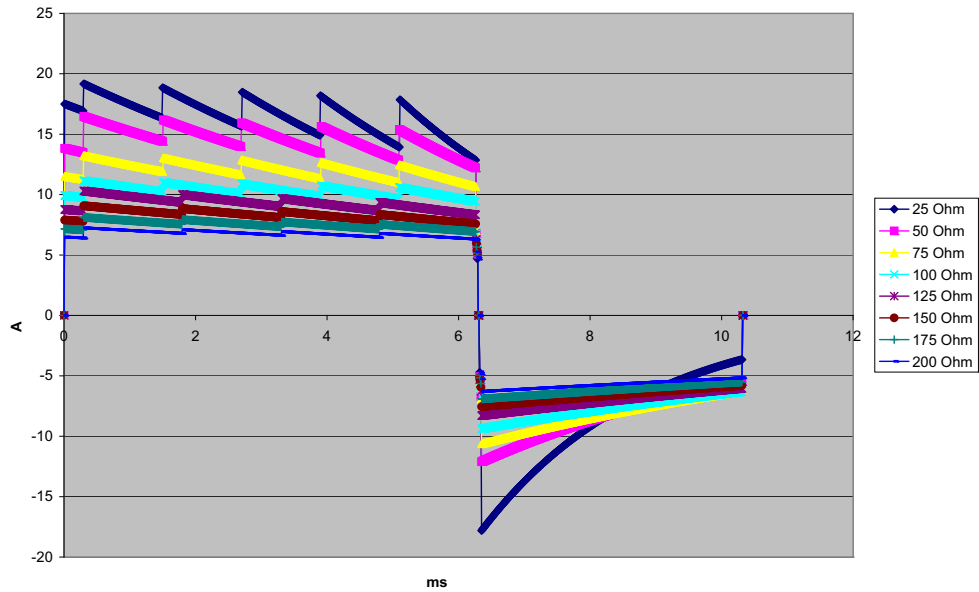


Figure A-6. Rectilinear Biphasic Waveform at 75 Joules

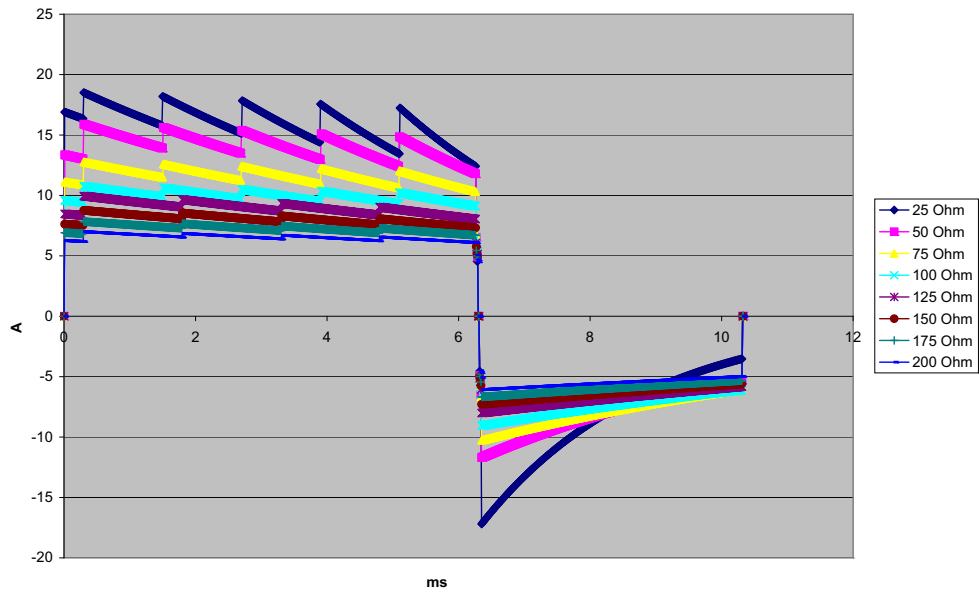


Figure A-7. Rectilinear Biphasic Waveform at 70 Joules

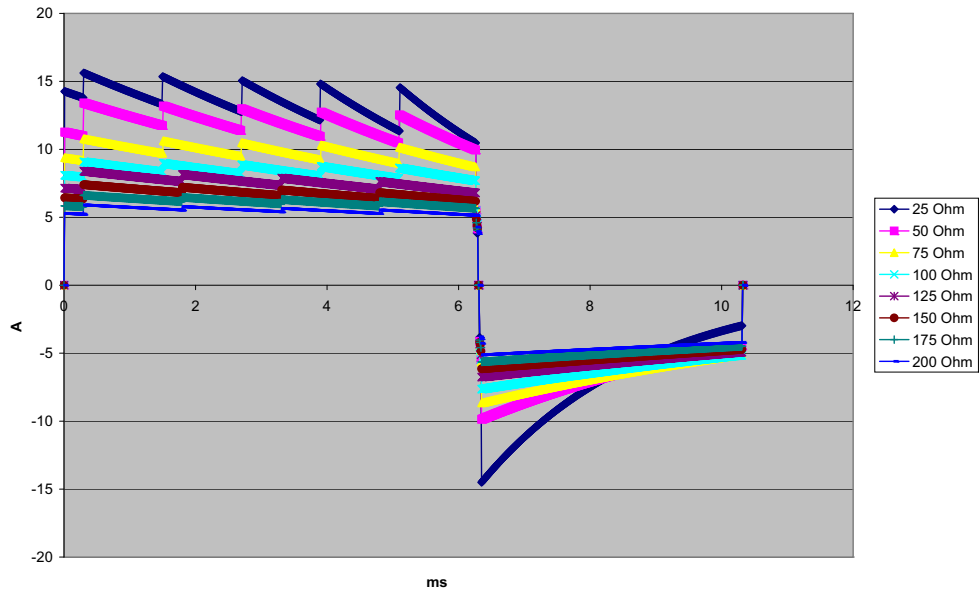


Figure A-8. Rectilinear Biphasic Waveform at 50 Joules

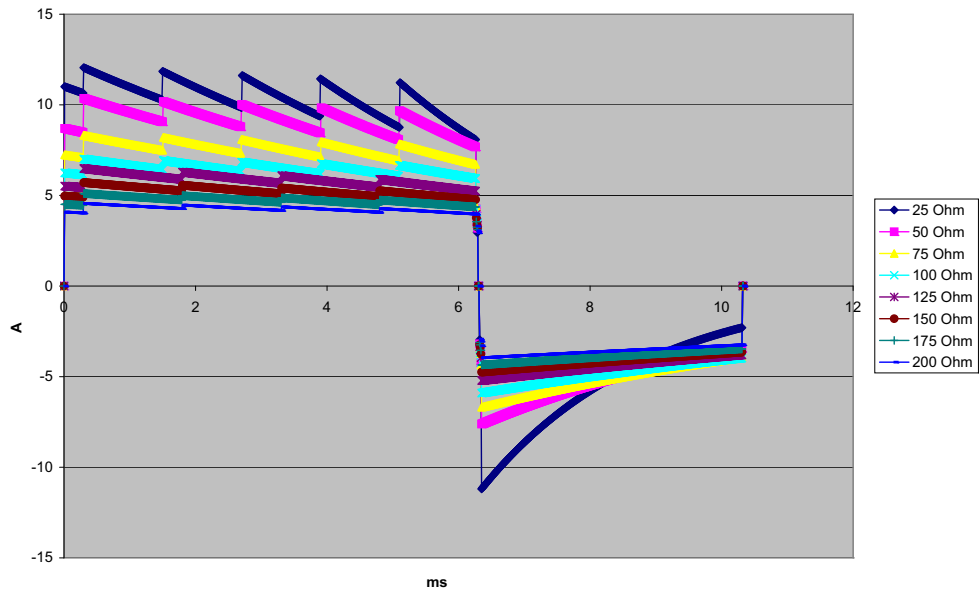


Figure A-9. Rectilinear Biphasic Waveform at 30 Joules

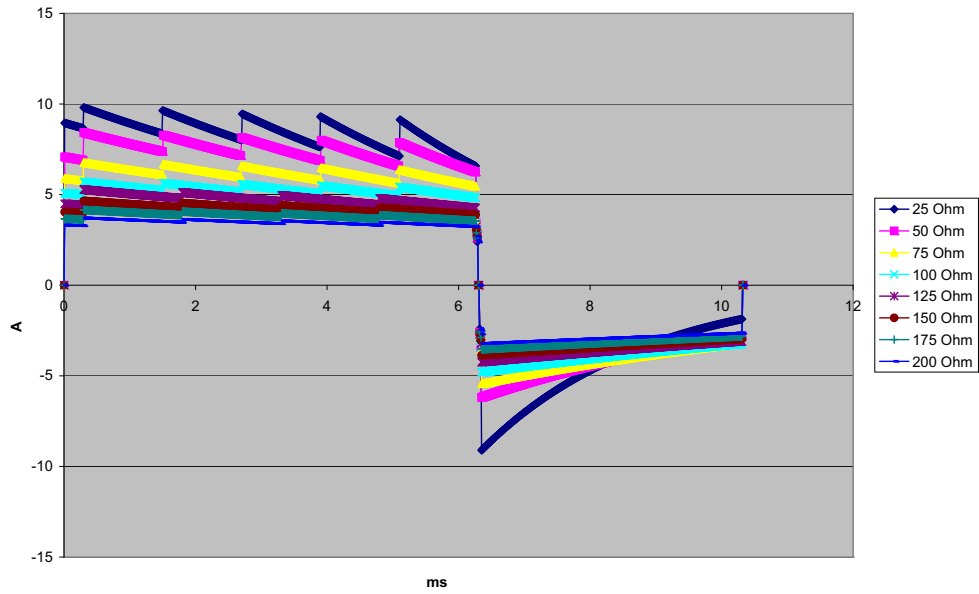


Figure A-10. Rectilinear Biphasic Waveform at 20 Joules

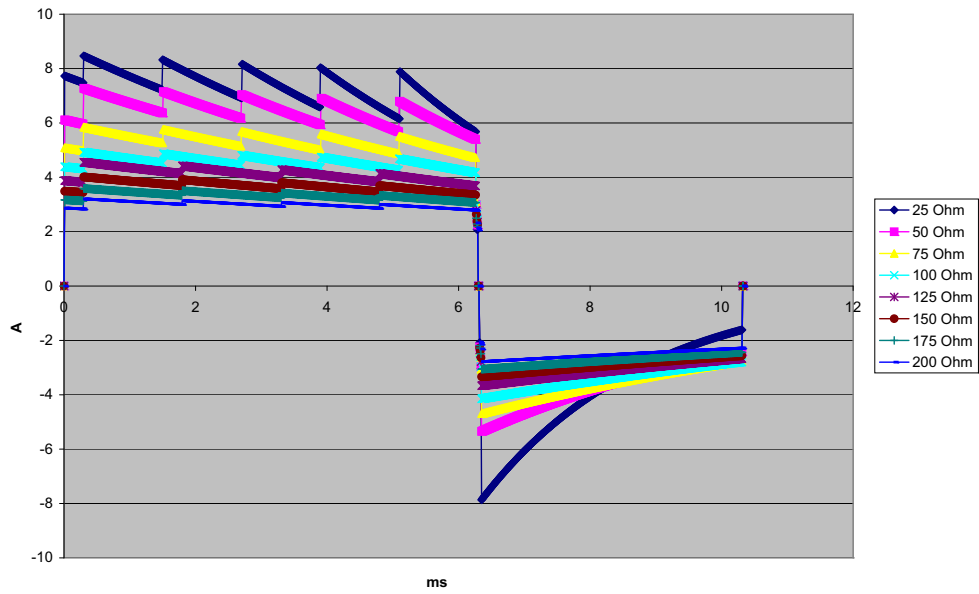


Figure A-11. Rectilinear Biphasic Waveform at 15 Joules

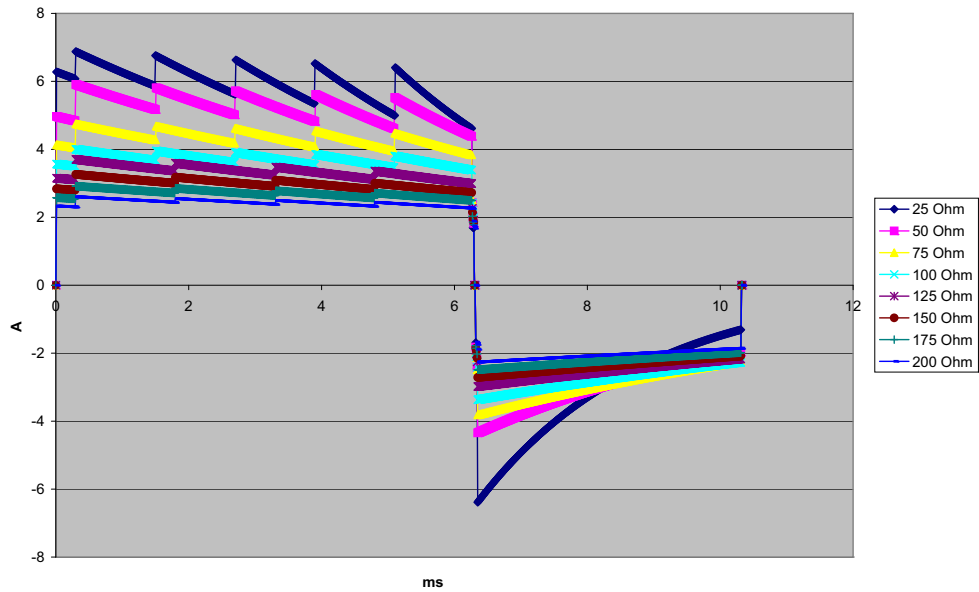


Figure A-12. Rectilinear Biphasic Waveform at 10 Joules

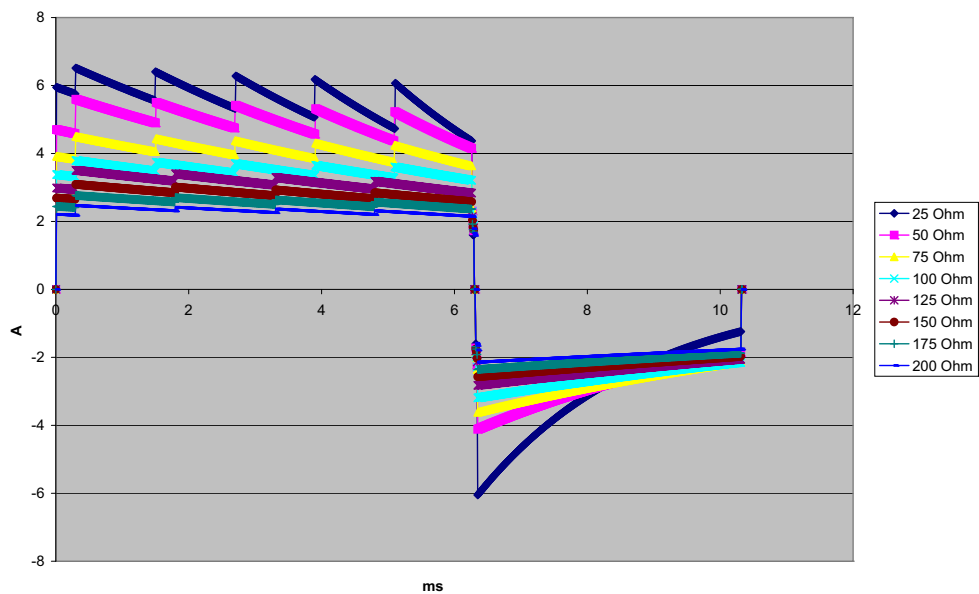


Figure A-13. Rectilinear Biphasic Waveform at 9 Joules

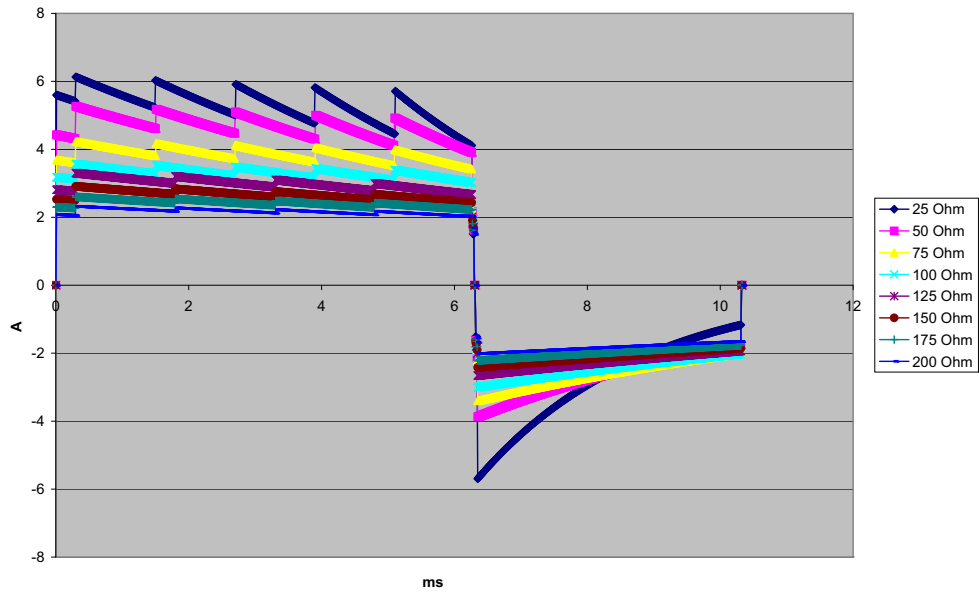


Figure A-14. Rectilinear Biphasic Waveform at 8 Joules

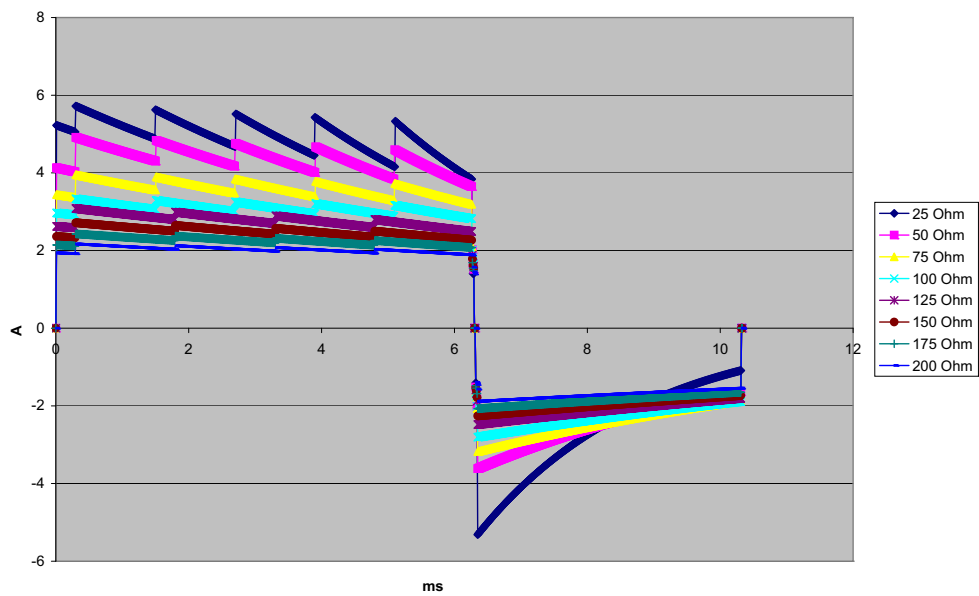


Figure A-15. Rectilinear Biphasic Waveform at 7 Joules

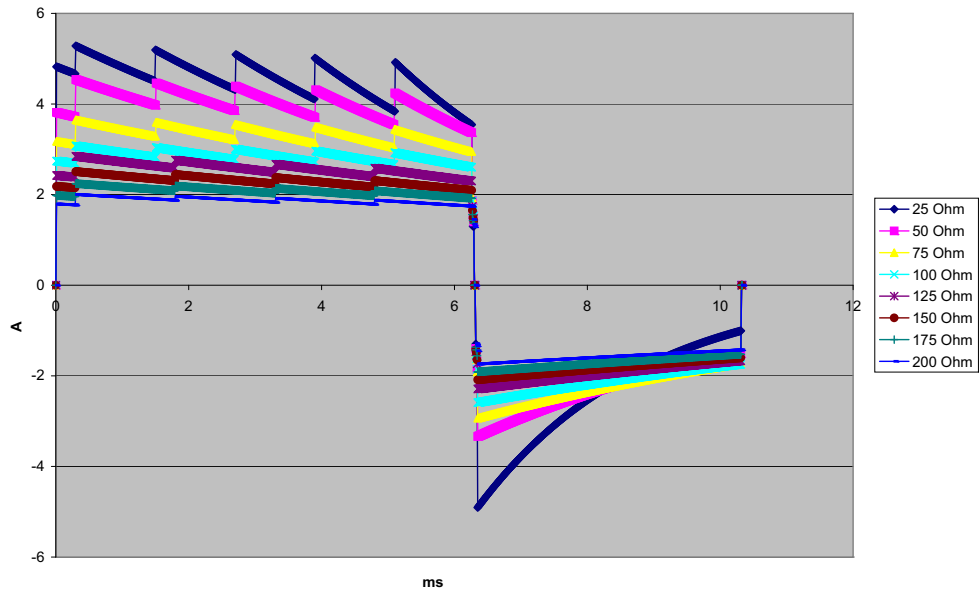


Figure A-16. Rectilinear Biphasic Waveform at 6 Joules

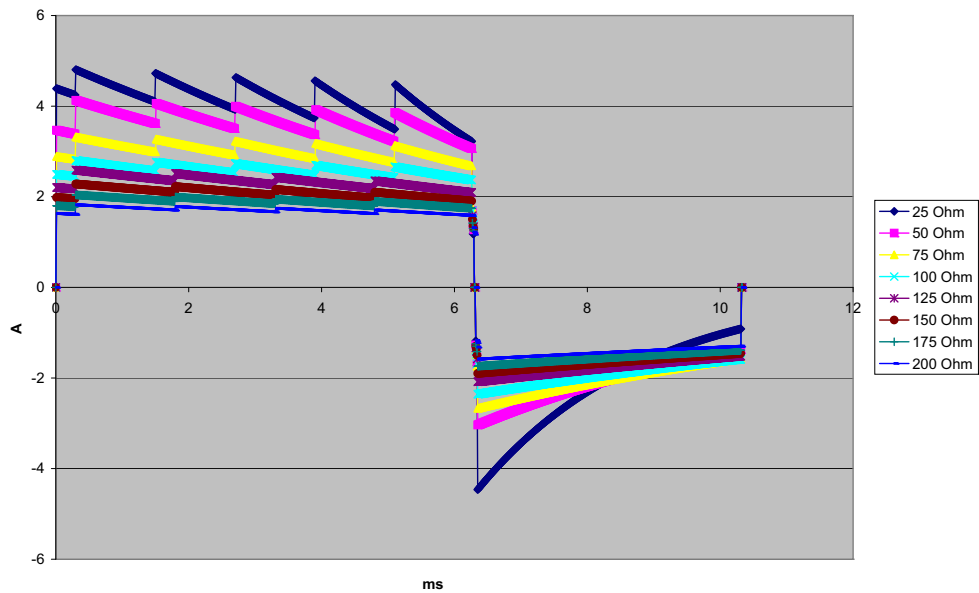


Figure A-17. Rectilinear Biphasic Waveform at 5 Joules

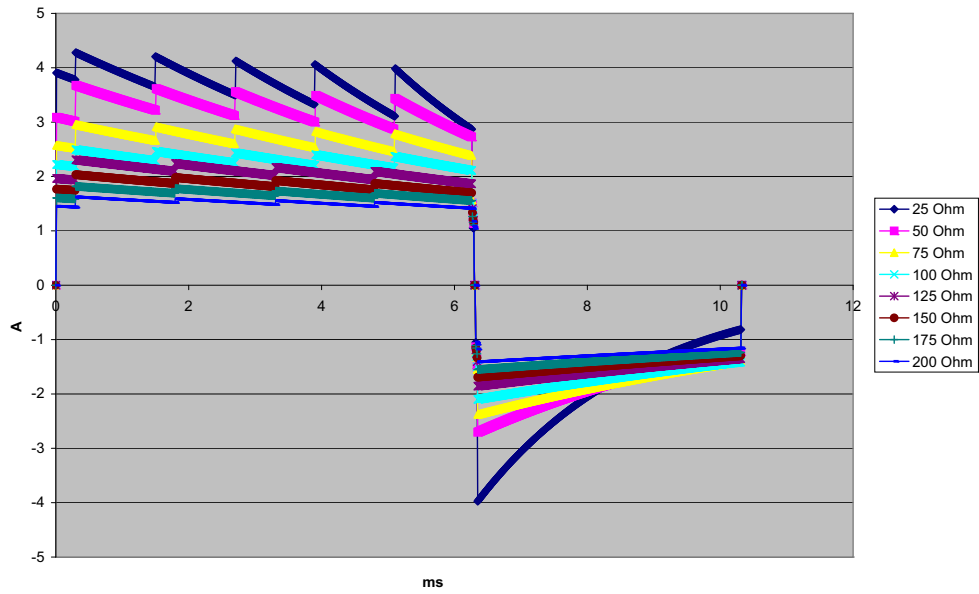


Figure A-18. Rectilinear Biphasic Waveform at 4 Joules

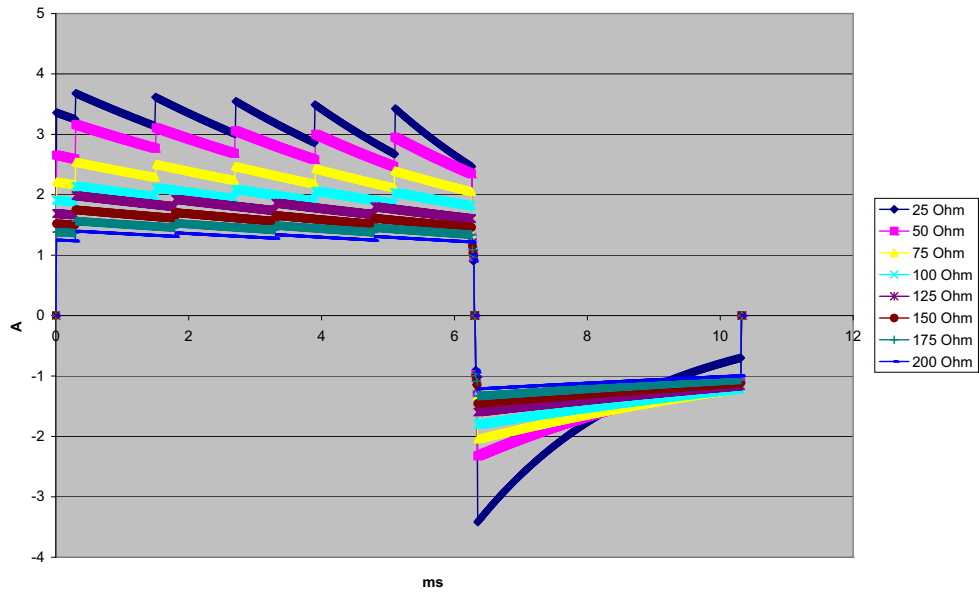


Figure A-19. Rectilinear Biphasic Waveform at 3 Joules

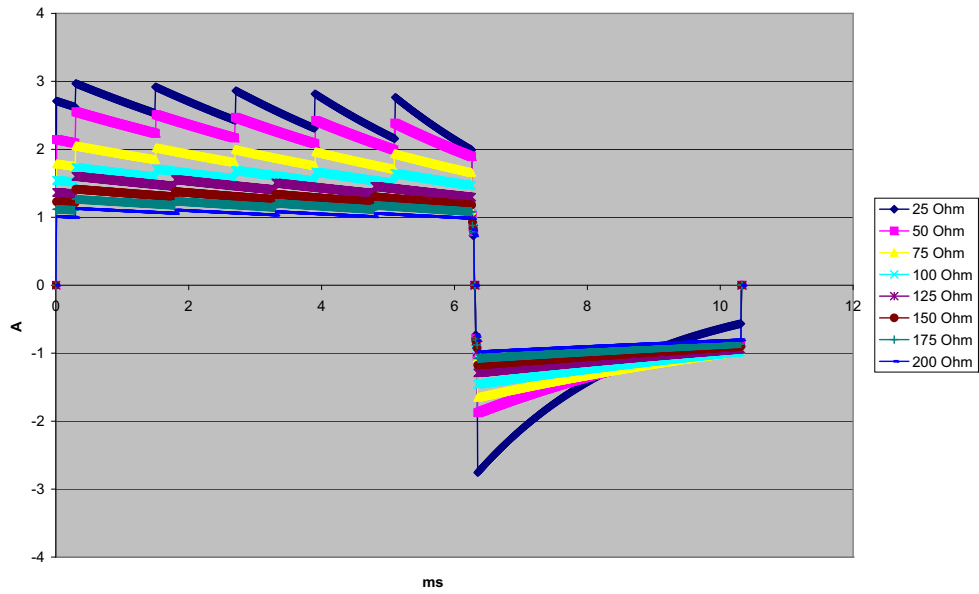


Figure A-20. Rectilinear Biphasic Waveform at 2 Joules

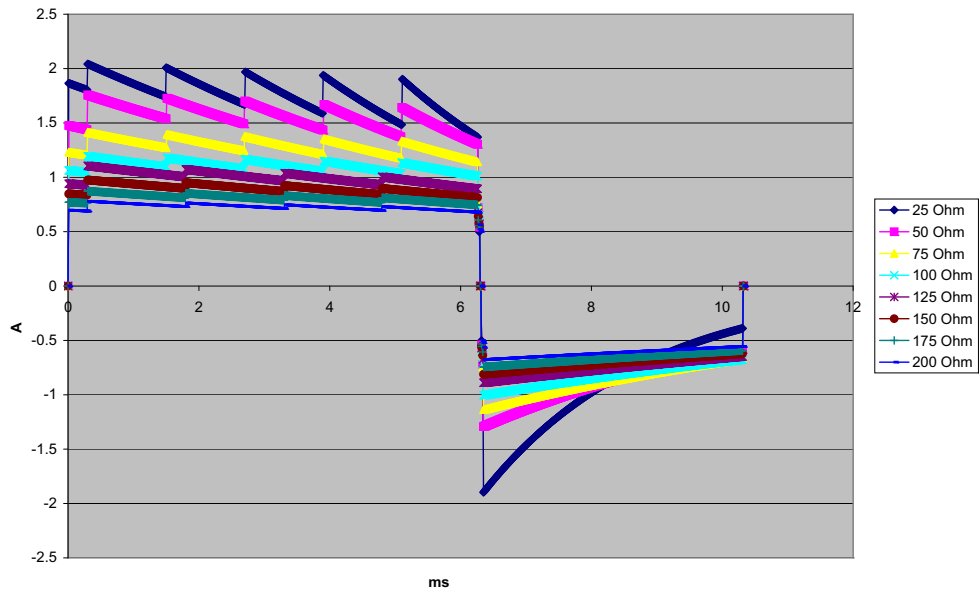


Figure A-21. Rectilinear Biphasic Waveform at 1 Joule



## Clinical Trial Results for the Biphasic Waveform

The efficacy of the ZOLL Rectilinear Biphasic waveform has been clinically verified during a study of defibrillation of Ventricular Fibrillation (VF) and Ventricular Tachycardia (VT). A feasibility study was performed initially for defibrillation of VF/VT (n=20) on two separate groups of patients to ensure waveform safety and energy selection. Subsequently, a separate, multicenter, randomized clinical trial was performed to verify the waveform's efficacy. A description of this study is provided below. The study was performed using ZOLL defibrillation systems consisting of ZOLL defibrillators, the ZOLL Rectilinear Biphasic waveform, and ZOLL defibrillation electrodes.

### Randomized Multicenter Clinical Trial for Defibrillation of Ventricular Fibrillation (VF) and Ventricular Tachycardia (VT)

**Overview:** The defibrillation efficacy of the ZOLL Rectilinear Biphasic waveform was compared to a monophasic damped sine waveform in a prospective, randomized, multicenter study of patients undergoing ventricular defibrillation for VF/VT during electrophysiological studies, ICD implants, and test. A total of 194 patients were enrolled in the study. Ten patients who did not satisfy all protocol criteria were excluded from the analysis, leaving a study population of 184.

**Objectives:** The primary goal of this study was to compare the first shock efficacy of the 120 J rectilinear biphasic waveform with a 200 J monophasic waveform. The secondary goal was to compare all shock (three consecutive 120, 150, and 170 joules) efficacy of the rectilinear biphasic waveform with that of a monophasic waveform (three consecutive 200, 300, and 360 joules). A significance level of  $p=0.05$  or less was considered statistically significant using Fischer's Exact test. Also, differences between the two waveforms were considered statistically significant when the customary 95% or AHA-recommended 90%<sup>1</sup> confidence interval between the two waveforms was greater than 0%.

**Results:** The study population of 184 patients had a mean age of  $63\pm 14$  years. Of these, 143 patients were male. There were no adverse events or injuries related to the study.

The first shock, first induction efficacy of biphasic shocks at 120 J was 99% versus 93% for monophasic shocks at 200 J ( $p=0.0517$ , 95% confidence interval of the difference of  $-2.7\%$  to  $16.5\%$  and 90% confidence interval of the difference of  $-1.01\%$  to  $15.3\%$ ).

Successful defibrillation with rectilinear biphasic shocks was achieved with 58% less delivered current than with monophasic shocks ( $14\pm 1$  amperes versus  $33\pm 7$  amperes,  $p=0.0001$ ).

The difference in efficacy between the rectilinear biphasic and the monophasic shocks was greater in patients with high transthoracic impedance (greater than 90 ohms). The first shock, first induction efficacy of biphasic shocks was 100% versus 63% for monophasic shocks for patients with high impedance ( $p=0.02$ , 95% confidence interval of the difference of  $-0.0217\%$  to  $0.759\%$  and 90% confidence interval of the difference of  $0.037\%$  to  $0.706\%$ ).

---

1. Kerber RE, et al., "Automated External Defibrillators for Public Access Defibrillation: Recommendations for Specifying and Reporting Arrhythmia Analysis Algorithm Performance, Incorporating New Waveforms, and Enhancing Safety," *Circ J Am Heart Assoc.* 1997;95:1677-1682.

"... the task force suggests that to demonstrate superiority of an alternative waveform over standard waveforms, the upper boundary of the 90% confidence interval of the difference between standard and alternative waveforms must be  $<0\%$  (ie, alternative is greater than standard)."

A single patient required a second biphasic shock at 150 joules to achieve 100% efficacy versus six patients for whom monophasic shocks of up to 360 joules were required for 100% total defibrillation efficacy.

**Conclusion:** The data demonstrate the equivalent efficacy of low energy rectilinear biphasic shocks compared to standard high energy monophasic shocks for transthoracic defibrillation for all patients at the 95% confidence level. The data also demonstrate the superior efficacy of low energy rectilinear biphasic shocks compared to standard high energy monophasic shocks in patients with high transthoracic impedance at the 90% confidence level. There were no unsafe outcomes or adverse events due to the use of rectilinear biphasic waveform.

## Pre-Clinical Study

To support pediatric usage for the ZOLL Rectilinear Bi-Phasic Waveform, ZOLL submitted pre-clinical data to the FDA as part of a 510(k) submission for its R Series device (cleared by the FDA under K060559). The protocol for this pre-clinical study, along with a summary of the results, have been submitted to FDA under R Series PMA application (P160022). A summary of this study is presented below.

To demonstrate the safety and efficacy of our Rectilinear Bi-Phasic Waveform when used to treat pediatric VF patients, ZOLL conducted a study using a porcine model of pediatric patients less than 8 years of age. This study included 18 piglets in three (3) size groups (two (2) animals weighing 4 kg, eight (8) animals weighing 8 kg, and eight (8) animals weighing 16 kg) and compared the defibrillation dose/response curves observed using proposed biphasic waveform with those observed using a standard monophasic damped sine wave (DSW) defibrillator to treat short duration (~ 30 seconds) ventricular fibrillation. The study demonstrated that the biphasic waveform defibrillates pediatric pigs with equal efficacy but lower energy (on a Joules/kg basis) than traditional monophasic damped sine wave defibrillators. To confirm the safety of the proposed biphasic waveform in pediatric patients, we studied and compared measures of cardiac function before and after both DSW and Rectilinear Bi-Phasic Waveform defibrillation shocks over a range of relevant energies. The study demonstrated that the biphasic defibrillation produced equivalent or milder disturbances of cardiac function when compared to traditional DSW defibrillation at the same energies.

Another animal study compared the ZOLL rectilinear biphasic (RLB) waveform to a biphasic truncated exponential (BTE) waveform. The study, using an immature porcine model (n=21), was a prospective, randomized, controlled design to determine the dose response curves for the RLB and BTE defibrillation waveforms. A weight range from 4 to 24 Kg for an animal represented a pediatric patient. The weight ranging from 4 to 8 Kg represented a patient less than 1 year old (infant subgroup), and the weight range from 16 to 24 Kg represented a pediatric patient between the ages of 2 and 8 years (young children subgroup).

The ZOLL RLB waveform demonstrated a superior capability to defibrillate a porcine pediatric model with < 90% of the D50 energy required for a BTE waveform (D50 energy: RLB  $25.6 \pm 15.7$  J, BTE  $28.6 \pm 17.0$  J,  $P = 0.0232$ ; D90 energy: RLB  $32.6 \pm 19.1$  J, BTE  $37.8 \pm 23.2$  J,  $P = 0.0228$ ).

The ECG ST segment changes (mV) and LV pressure changes (dP/dt) following a defibrillation shock were compared between the RLB waveform to the BTE waveform. The RLB waveform had an average ST segment increase above baseline of  $0.138 \pm 0.136$  mV (N=401 shocks) compared to the BTE waveform's average increase of  $0.146 \pm 0.148$  mV (N=396 shocks). The RLB waveform had an average dP/dt at the 40 mmHg threshold (the point in time when an animal's blood pressure exceeded 40 mmHg spontaneously) of  $1987 \pm 411$  mmHg/s

(N=496 shocks) compared to the BTE waveform's average dP/dt of  $2034 \pm 425$  mmHg/s (N=496 shocks).

## Published Clinical Data

Additional clinical data was included with PMA application P160022 to support out-of-hospital use of ZOLL's Rectilinear Bi-Phasic defibrillation waveform. The data reported by Hess et al in Resuscitation (82 (2011) 685–689) is considered sufficient to support ZOLL's defibrillation waveform in the out-of-hospital environment. The resulting clinical paper, "Performance of a rectilinear biphasic waveform in defibrillation of presenting and recurrent ventricular fibrillation: A prospective multicenter study," was included with PMA application P160015. A summary of the study is presented below:

**Objectives:** The study tested the hypothesis that shock success differs with initial and recurrent episodes of ventricular fibrillation (VF).

**Methods:** From September 2008 to March 2010 out-of-hospital cardiac arrest patients with VF as the initial rhythm at 9 study sites were defibrillated by paramedics using a rectilinear biphasic waveform. Shock success was defined as termination of VF within 5 s post-shock. The study used generalized estimating equation (GEE) analysis to assess the association between shock type (initial versus defibrillation) and shock success.

**Results:** Ninety-four patients presented in VF. Mean age was 65.4 years, 78.7% were male, and 80.9% were bystander-witnessed. VF recurred in 75 (79.8%). There were 338 shocks delivered for initial (n = 90) or recurrent (n = 248) VF available for analysis. Initial shocks terminated VF in 79/90 (87.8%) and subsequent shocks in 209/248 (84.3%). GEE odds ratio (OR) for shock type was 1.37 (95% CI 0.68–2.74). After adjusting for potential confounders, the OR for shock type remained insignificant (1.33, 95% CI 0.60–2.53). The study observed no significant difference in ROSC (54.7% versus 52.6%, absolute difference 2.1%, p = 0.87) or neurologically intact survival to hospital discharge (21.9% versus 33.3%, absolute difference 11.4%, p = 0.31) between those with and without VF recurrence.

**Conclusions:** Presenting VF was terminated with one shock in 87.8% of cases. The study observed no significant difference in the frequency of shock success between initial versus recurrent VF. VF recurred in the majority of patients and did not adversely affect shock success, ROSC, or survival.

## Randomized Multi-Center Clinical trial for Cardioversion of Atrial Fibrillation (AF)

**Overview:** The defibrillation efficacy of ZOLL's Rectilinear Biphasic Waveform was compared to a monophasic damped sine waveform in a prospective randomized multi-center study of patients undergoing cardioversion of their atrial fibrillation. A total of 173 patients entered the study. Seven (7) patients who did not satisfy all protocol criteria were excluded from the analysis. ZOLL disposable gel electrodes with surface areas of 78 cm<sup>2</sup> (anterior) and 113 cm<sup>2</sup> (posterior) were used exclusively for the study.

**Objective:** The primary goal of the study was to compare the total efficacy of four consecutive rectilinear biphasic shocks (70J, 120J, 150J, 170J) with four consecutive monophasic shocks (100J, 200J, 300J, 360J). The significance of the multiple shocks efficacy was tested statistically via two procedures, the Mantel-Haenszel statistic and the log-rank test, significance level of p=0.05 or less was considered statistically significant. The data are completely

analogous to the comparison of two "survival" curves using a life-table approach where shock number plays the role of time.

The secondary goal was to compare the first shock success of rectilinear biphasic and monophasic waveforms. A significance level of  $p=0.05$  or less was considered statistically significant using Fisher Exact tests. Also, differences between the two waveforms were considered statistically significant when the 95% confidence interval between the two waveforms was greater than 0%.

**Results:** The study population of 165 patients had a mean age of  $66\pm 12$  years with 116 male patients.

The total efficacy of consecutive rectilinear biphasic shocks was significantly greater than that of monophasic shocks. The following table displays the Kaplan-Meier (product-limit) "survival" curves for each of the two waveforms. As all patients begin in the failure mode, the estimated life-table probabilities refer to the chance of still being in failure after the  $k^{\text{th}}$  shock ( $k=1,2,3,4$ ):

**Table A-3. Kaplan-Meier Estimate for the Probability of Shock Failure**

Shock #	Biphasic	Monophasic
0	1.000	1.000
1	0.318	0.792
2	0.147	0.558
3	0.091	0.324
4	0.057	0.208

As can be seen from the table, the Biphasic experience is superior over the entire course of shocks delivered. The one degree of freedom chi-square statistic for the Mantel-Haenszel test is 30.39 ( $p<0.0001$ ). Similarly, the log-rank test, also a one degree of freedom chi-square statistic, is 30.38 ( $p<0.0001$ ). The residual number of patients not successfully treated after four shocks is 5.7% for biphasic compared to 20.8% for monophasic.

There was a significant difference between the first shock efficacy of biphasic shocks at 70J of 68% and that of monophasic shocks at 100J of 21% ( $p=0.0001$ , 95% confidence interval of the difference of 34.1% to 60.7%).

Successful cardioversion with rectilinear biphasic shocks was achieved with 48% less delivered current than with monophasic shocks ( $11\pm 1$  vs.  $21\pm 4$  A,  $p<0.0001$ ).

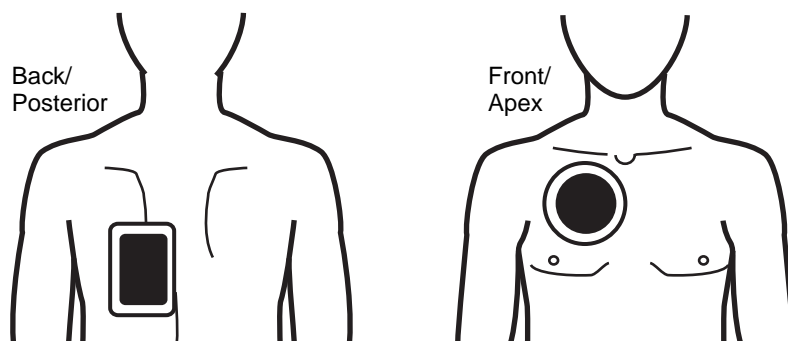
One half of the patients who failed cardioversion after four consecutive escalating monophasic shocks were subsequently successfully cardioverted using a biphasic shock at 170J. No patient was successfully cardioverted using a 360J monophasic shock after the patient had failed cardioversion with biphasic shocks.

**Conclusion:** The data demonstrate the superior efficacy of low energy rectilinear biphasic shocks compared to high energy monophasic shocks for transthoracic cardioversion of atrial fibrillation. There were no unsafe outcomes or adverse events due to the use of Rectilinear Biphasic Waveform.

## Synchronized Cardioversion of Atrial Fibrillation

Cardioversion of atrial fibrillation (AF) and overall clinical effectiveness is enhanced by proper pad placement. Clinical studies (refer to above) of the M Series Biphasic Defibrillator Waveform demonstrated that high conversion rates are achieved when defibrillation pads are placed as shown in the diagram below.

Recommended Anterior/Posterior Placement



Place the front (apex) pad on the third intercostal space, mid clavicular line on the right anterior chest. The back/posterior pad should be placed in the standard posterior position on the patient's left as shown.

## ECG Rhythm Analysis Algorithm Accuracy

Sensitivity and specificity are expressions of ECG rhythm analysis algorithm performance when compared to ECG interpretation by a clinician or expert. Sensitivity refers to the algorithm's ability to correctly identify shockable rhythms (as a percentage of the total number of shockable rhythms). Specificity refers to the algorithm's ability to correctly identify nonshockable rhythms (as a percentage of the total number of nonshockable rhythms).

The data in Table A-4 and Table A-5 summarize the accuracy of the ECG rhythm analysis algorithm as tested against ZOLL's ECG rhythm database. Rhythm sources included data records from ZOLL devices and public domain databases recorded with electrode systems and ECG signal processing characteristics similar to the R Series. Data records were of appropriate length to allow for satisfactory analysis.

The algorithm sequence takes approximately 9 seconds and proceeds as follows:

- Divides the ECG rhythm into 3-second segments
- Filters and measures noise, artifact, and baseline wander
- Measures baseline content ("waviness" at the correct frequencies – frequency domain analysis) of signal
- Measures QRS rate, width, and variability
- Measures amplitude and temporal regularity (autocorrelation) of peaks and troughs
- Determines if multiple 3-second segments are shockable and then prompts the operator to treat the patient

**Table A-4. Clinical Performance Results (Adult Patients)**

Rhythms	Sample Size	Performance Goals	Observed Performance	90% One-sided Lower Confidence Limit
<b>Shockable</b>		<b>Sensitivity</b>		
Coarse VF	536	>90%	100.0%	99.4%
Rapid VT	80	>75%	98.8%	99.2%
<b>Nonshockable</b>		<b>Specificity</b>		
NSR	2210	>99%	99.6%	99.8%
AF, SB, SVT, heart block, idioventricular, PVCs	819	>95%	100.0%	99.6%
Asystole	115	>95%	100.0%	97.4%
<b>Intermediate</b>				
Fine VF	69	Report only	94.2%	87.2%
Other VT	28	Report only	100.0%	89.9%

Table A-5. Clinical Performance Results (Pediatric Patients)

Rhythms	Sample Size (9 second records)	Performance Goals	Observed Performance	90% One-sided Lower Confidence Limit
<b>Shockable (49 patients)</b>		<b>Sensitivity</b>		
Coarse VF	49	>90%	100.0%	93.1%
Rapid VT	79	>75%	100.0%	96.3%
<b>Nonshockable (155 patients)</b>		<b>Specificity</b>		
NSR	208	>99%	100.0%	98.6%
AF, SB, SVT <sup>a</sup> , heart block, idioventricular, PVCs	348	>95%	99.4%	98.2%
Asystole	29	>95%	100.0%	90.2%
<b>Intermediate (16 patients)</b>				
Fine VF	0	Report only	—	—
Other VT	44	Report only	81.8%	89.6%

a. 161 of the 348 abnormal rhythm records were SVT (72 patients). The SVT heart rates ranged from 152 to 302 beats per minute.

Arrhythmia performance is reported according to the article, Kerber RE, Becker LB, Bourland JD, Cummins RO, Hallstrom AP, Michos MB, Nichol G, Ornato JP, Thies WH, White RD, Zuckerman BD. “Automated External Defibrillators for Public Access Defibrillation: Recommendations for Specifying and Reporting Arrhythmia Analysis Algorithm Performance, Incorporating New Waveforms, and Enhancing Safety,” *Circ J Am Heart Assoc.* 1997;95:1677-1682.

## References

Young KD, Lewis RJ. “What is confidence? Part 2: Detailed definition and determination of confidence intervals”. *Ann Emerg Med.* September 1997;30:311-318.

Beyer WH. Percentage Points, F-Distribution Table. *CRC Standard Mathematical Tables.* 28<sup>th</sup> ed. Boca Raton, Fla: CRC Press; 1981:573.





# Appendix B

## R Series Accessories

---

The following accessories are compatible for use with R Series products. To order any of these items, contact your local ZOLL representative.

SPU = Single Patient Use

<b>Electrodes/Pads, Paddles, and Connectors</b>
OneStep resuscitation electrodes
OneStep Basic Pacing/defibrillation electrodes with Monitor while Pace (MWP)
OneStep resuscitation electrodes with CPR (anterior/posterior)
OneStep resuscitation electrodes with CPR (anterior/anterior)
OneStep Complete
OneStep pediatric resuscitation electrodes (1 or 8 pair/box)
OneStep pediatric resuscitation electrodes with CPR (1 or 8 pair/box)
Adult, Multi-Function Pacing/Defibrillation Stat-padz (12 pair/box)
Pediatric, Multi-Function Pacing/Defibrillation Pedi-padz
External Paddle Assembly Apex/Sternum with built in pediatric electrodes
External autoclavable paddles
Internal autoclavable handles, no switch
Internal autoclavable handles, with switch
Molded autoclavable internal handles, no switch
Molded autoclavable internal handles, with switch

<b>Cables</b>
OneStep Cable (100-240V, 50/60Hz)
OneStep Pacing Cable (100-240V, 50Hz)
AAMI 3-Lead Wire ECG Patient Cable (6' or 12')
AAMI 3-Lead Wire ECG Patient Cable, ESU
IEC 3-Lead ECG Patient Cable
AAMI 5-Lead Wire ECG Patient Cable
IEC 5-Lead Wire ECG Patient Cable
Power Cord Extension Cable (12")
AC power cord
<b>Batteries and Chargers</b>
SurePower Charger
SurePower Battery
<b>SpO<sub>2</sub> Sensors and Cables</b>
LNCS Amtx Single use sensor for patients > 30 kg
LNCS Pmtx Single use sensor for Pediatrics and Slender Adults 10-50 kg
LNCS Inf-L Single use sensor for Infants 3-20 kg
LNCS Neo-L Single use sensor for Neonates < 3 kg
LNCS NeoPt-L Single use sensor for Neonates < 1 kg (Pre-term)
LNCS DCI Reusable sensor for Adults and Pediatrics > 30 kg
LNCS DCIP Reusable sensor for Pediatrics 10-50 kg
LNC-4 4' Reusable Patient Cable
LNC-10 10' Reusable Patient Cable
LNC Ext LNC Extension Cable, DB-9 Termination, 4ft
LNCS-to-LNOP Adapter Cable, LNCS Sensor to LNOP Patient Cable
LNOP DC-12 LNOP Adult Reusable Direct Connect 12' Cable
<b>EtCO<sub>2</sub> Sensors and Cables</b>
<b>Mainstream</b>
CAPNOSTAT 5 CO <sub>2</sub> Sensor and Cable
SPU Pediatric/Adult Airway Adapter
SPU Neonatal/Pediatric Airway Adapter

Reusable Adult Airway Adapter
Reusable Neonatal/Pediatric Airway Adapter
SPU Pediatric/Adult Airway Adapter with Mouthpiece
CAPNO <sub>2</sub> mask, Large Adult
CAPNO <sub>2</sub> mask, Standard Adult
CAPNO <sub>2</sub> mask, Pediatric
<b>Sidestream</b>
LoFlo Module and Cable
SPU Nasal CO <sub>2</sub> Sampling Cannula, Adult
SPU Nasal CO <sub>2</sub> Sampling Cannula, Pediatric
SPU Nasal CO <sub>2</sub> Sampling Cannula, Infant/neonate
SPU Oral/Nasal CO <sub>2</sub> Sampling Cannula, Adult
SPU Oral/ Nasal CO <sub>2</sub> Sampling Cannula, Pediatric
SPU Nasal CO <sub>2</sub> Sampling with O <sub>2</sub> Delivery Cannula, Adult
SPU Nasal CO <sub>2</sub> Sampling with O <sub>2</sub> Delivery Cannula, Pediatric
SPU Oral/Nasal CO <sub>2</sub> Sampling with O <sub>2</sub> Delivery Cannula, Adult
SPU Oral/Nasal CO <sub>2</sub> Sampling with O <sub>2</sub> Delivery Cannula, Pediatric
SPU Adult/Pediatric Airway Adapter Kit (ET tube sizes > 4.0 mm)
SPU Adult/Pediatric Airway Adapter Kit with Nafion tubing (ET tube sizes > 4.0 mm)
SPU Pediatric/Infant Airway Adapter Kit (ET tube sizes ≤ 4.0 mm)
SPU Pediatric/Infant Airway Adapter Kit with Nafion tubing (ET tube sizes ≤ 4.0 mm)
<b>NIBP Cuffs and Hoses</b>
Thigh, reusable: 38 to 50 cm (14.96 to 19.69 in.)
Large Adult, reusable: 31 to 40 cm (12.20 to 15.75 in.)
Adult, reusable: 23 to 33 cm (9.06 to 12.99 in.)
Small Adult, reusable: 17 to 25 cm (6.69 to 9.84 in.)
Child, reusable: 12 to 19 cm (4.72 to 7.48 in.)
Neonate #5, disposable: 8.0 cm to 15.0 cm (3.1 to 5.9 in.)
Neonate #4, disposable: 7.0 to 13.0 cm (2.8 to 5.1 in.)
Neonate #3, disposable: 6.0 to 11.0 cm (2.4 to 4.3 in.)
Neonate #2, disposable: 4.0 to 8.0 cm (1.6 to 3.1 in.)
Neonate #1, disposable: 3.0 to 6.0 cm (1.2 to 2.4 in.)
Air hose with pneumatic fittings 3 m (9.8 ft.)
Air hose with pneumatic fittings 1.5 m (4.9 ft.)
<b>Miscellaneous</b>
Recorder Paper, 80mm Fan Fold (10 or 20 pkgs)
R Series Data COMM Card
R Series Data COMM II Card

(This page intentionally left blank.)

# Appendix C

## Wi-Fi Radio Module Information

---

If this defibrillator contains an optional low power Wi-Fi radio module, it transmits information between the defibrillator and a wireless network (infrastructure mode). The module complies with the following standards:

- Part 15 of the FCC Rules. Operation is subject to the following two conditions: (1) this device may not cause harmful interference, and (2) this device must accept any interference received including interference that may cause undesired operation (of the radio function).
- RSS 247 of Industry & Science Canada. Operation is subject to the following two conditions: (1) this device may not cause harmful interference, and (2) this device must accept any interference received including interference that may cause undesired operation (of the radio function).

**Note:** “Harmful interference” is defined by the FCC as follows: Any emission, radiation or induction that endangers the functioning of a radio navigation service or of other safety services; or seriously degrades, obstructs or repeatedly interrupts a radiocommunications service operating in accordance with FCC rules.

Changes or modifications to Wi-Fi settings on R Series wireless communication accessories not expressly approved by the administrator responsible for compliance could void the user’s authority to operate the equipment.

The user is cautioned to maintain 8 inches (20 cm) of space from the product to ensure compliance with FCC requirements.

FCC/IC/EU: This device is limited to indoor use in the 5150 MHz to 5250 MHz band.

Radio	Frequency Range (MHz)	Output Power (EIRP) (dBm / Watts)
802.11a/b/g/n	2412 - 2472 5180 - 5320 5500 - 5700	14.8 dBm / 0.03 W 15.4 dBm / 0.035 W 15.3 dBm / 0.034 W

(This page intentionally left blank.)

**ZOLL**

R Series®  
Pulse Oximetry (SpO<sub>2</sub>)

The issue date for the R Series Pulse Oximetry (SpO<sub>2</sub>) guide (**REF** 9650-0901-01 Rev. F) is December, 2017. If more than three years have elapsed since this date, contact ZOLL Medical Corporation to determine if additional product information updates are available.

ZOLL, OneStep and R Series are trademarks or registered trademarks of ZOLL Medical Corporation.

All other trademarks and registered trademarks are property of their respective owners.

Copyright © 2017 by ZOLL Medical Corporation. All rights reserved.



## Indication of use

The R Series system is indicated for the continuous, noninvasive monitoring of arterial oxygen saturation (SpO<sub>2</sub>) and pulse rate during both no motion and patient motion conditions for adult patients, and no motion conditions for pediatric and neonatal patients in a hospital or prehospital environment.

## Contraindications for Use

There are no known contraindications for the use of the SpO<sub>2</sub> monitor.

## General Information

Federal (U.S.A.) law restricts this defibrillator to sale by or on the order of a physician.

---

# Pulse Oximetry (SpO<sub>2</sub>)

---

## Product Description

The R Series<sup>®</sup> pulse oximeter continuously and noninvasively measures the oxygen saturation of arteriolar hemoglobin at a peripheral site (e.g., foot, toe, or finger). It is used to monitor patients at risk of developing hypoxemia. SpO<sub>2</sub> monitoring provides information about the circulatory and respiratory systems and supplies details of oxygen transportation in the body. This option is widely used because it is noninvasive, continuous, easily applied, and painless.

The oximeter sensor contains two emitters that transmit red and infrared light through the monitored site. This light passes through the patient's tissues and is received by a photodetector in the sensor. Because oxygen-saturated blood absorbs light differently than unsaturated blood, the amount of red and infrared light absorbed by blood flowing through the monitored site can be used to calculate the ratio of oxygenated hemoglobin to total hemoglobin in arterial blood. The monitor displays this ratio as percent SpO<sub>2</sub>. Normal values typically range from 95% to 100% at sea level.

The quality of SpO<sub>2</sub> measurements depends on the correct size and application of the oximetry sensor, adequate blood flow through the sensor site, and the sensor's exposure to ambient light. For correct placement and location of the sensors, refer to the *Directions for Use* contained in all LNCS<sup>®</sup> oximetry sensor packages.

## How to Use This Insert

This insert supplements your defibrillator's *R Series Operator's Guide* and describes how to set up, use, and maintain the R Series pulse oximeter. Keep this insert with your defibrillator's *R Series Operator's Guide* and all other inserts for R Series options.

Your defibrillator's *R Series Operator's Guide* provides information that users need for the safe and effective use and care of R Series products. Important safety information related to use of the R Series pulse oximeter appears in "Safety Considerations" on page 3. Additional important safety information is packaged with each oximetry sensor.

## SpO<sub>2</sub> Intended Use

The R Series pulse oximeter, with the Masimo<sup>®</sup> SET<sup>®</sup> technology and the LNCS series of oximeter sensors, is indicated for the continuous noninvasive monitoring of functional oxygen saturation of arterial hemoglobin (SpO<sub>2</sub>) and pulse rate.

The R Series pulse oximeter is indicated for use with adult, pediatric, and neonatal patients during both no-motion and motion conditions, and for patients who are well or poorly perfused, in hospitals, hospital-type facilities, and mobile environments.

Oxygen saturation measurements derived from pulse oximetry are highly dependent on patient conditions and proper placement of the sensor. Patient conditions such as smoke inhalation might result in erroneous oxygen saturation readings. If the accuracy of any reading is in doubt, verify the reading using another clinically accepted method, such as arterial blood gas measurements.

The R Series Pulse Oximetry option is intended for use only with ZOLL/Masimo LNCS sensors.

## Measurement Complications

If the accuracy of any reading is suspect, first check the patient's vital signs by alternate means and then check the R Series Pulse Oximeter for proper functioning.

Inaccurate measurements may be caused by:

- Incorrect sensor application or use.
- Significant levels of dysfunctional hemoglobins (for example, carboxyhemoglobin or methemoglobin).
- Intravascular dyes, such as indocyanine green or methylene blue.
- Exposure to excessive illumination, such as surgical lamps (especially those with a xenon light source), bilirubin lamps, fluorescent lights, infrared heating lamps, or direct sunlight.
- Excessive patient movement.
- Patient conditions, such as smoke inhalation.
- Venous pulsations.
- Certain nail aberrations, nail polish, fungus, and so on.
- Placement of a sensor on a limb with restricted blood flow, a blood pressure cuff, an arterial catheter, or an intravascular line.

A weak pulse signal on the display might indicate a poorly applied sensor or a poorly chosen monitoring site. Loss of pulse signal can occur when:

- The sensor is applied too tightly.
- There is excessive illumination from light sources, such as a surgical lamp, a bilirubin lamp, or sunlight.
- A blood pressure cuff is inflated on the limb used for the oximeter sensor.
- Excessive patient movement.
- The patient has hypotension, severe vasoconstriction, or hypothermia.
- An arterial occlusion exists proximal to the sensor.
- The patient is in cardiac arrest or shock.

## SPO<sub>2</sub> Connector and Sensors

The SpO<sub>2</sub> connector is located on the rear panel of the R Series unit. Use only ZOLL or Masimo accessories and sensors with the R Series Pulse Oximetry option.

Each sensor is designed for application to a specific anatomical site on patients within a certain weight range. To ensure optimal performance, use an appropriate sensor, apply it as described in the sensor's *Directions for Use*, and always observe all warnings and cautions.

---

# Safety Considerations

## Warnings



### General

Carefully read your defibrillator's *R Series Operator's Guide*, these operating instructions, and the *Directions for Use* that accompany the Masimo oximeter sensors.

Only qualified personnel should operate the R Series pulse oximeter.

Do not use the pulse oximeter as an apnea monitor.

Do not immerse the R Series defibrillator, cables, or sensors in water, solvents, or cleaning solutions.

Consider a pulse oximeter an early warning device. When a trend toward patient deoxygenation is indicated, blood samples should be analyzed by a laboratory co-oximeter to completely understand the patient's condition.

If an alarm occurs while audible alarms are suspended, only visual alarm indicators are provided.

Interfering substances: Carboxyhemoglobin and methemoglobin can erroneously alter SpO<sub>2</sub> readings. The level of change is approximately equal to the amount of carboxyhemoglobin or methemoglobin present. Dyes or any substance containing dyes that alter arterial pigmentation might cause erroneous readings.

Do not use the R Series pulse oximeter or oximeter sensors during magnetic resonance imaging (MRI). Induced current could cause burns. The pulse oximeter might affect the MRI image and the MRI unit might interfere with the accuracy of oximetry measurements.

Carefully arrange patient cabling to reduce the possibility of patient entanglement or strangulation.

Use only the line cord supplied by ZOLL Medical Corporation for continued safety and EMC performance.

### Oximeter sensors

Use only ZOLL/Masimo LNCS oximeter sensors. Other manufacturers' sensors might not perform properly with the R Series oximeter.

Tissue damage can result from incorrect application or use of a sensor (for example, wrapping the sensor too tightly, applying supplemental tape, failing to periodically inspect the sensor site). To ensure skin integrity, correct positioning, and sensor adhesion, inspect the sensor site as directed in the *Directions for Use* provided with the sensor.

Do not use damaged sensors or cables.

Do not use a sensor with exposed optical components.

Do not sterilize a sensor by irradiation, steam, or ethylene oxide. Refer to the cleaning instructions in the *Directions for Use* for reusable LNCS sensors.

Do not allow the sensor to remain on the same site for a prolonged period, especially when monitoring neonates. Check the application site at regular intervals (at least every 2 hours) and change the site if any compromise in skin quality occurs.

Do not attach the oximeter sensor to a limb being monitored with a pressure cuff or with restricted blood flow.

A poorly applied sensor might give incorrect saturation readings. A weak pulse signal on the display might indicate a poorly applied sensor or a poorly chosen monitoring site.

Choose a site with sufficient perfusion to ensure accurate oximetry values.

Certain nail aberrations, nail polish, fungus, and so on might cause inaccurate oximetry readings. Remove any nail polish or move the sensor to an unaffected digit.

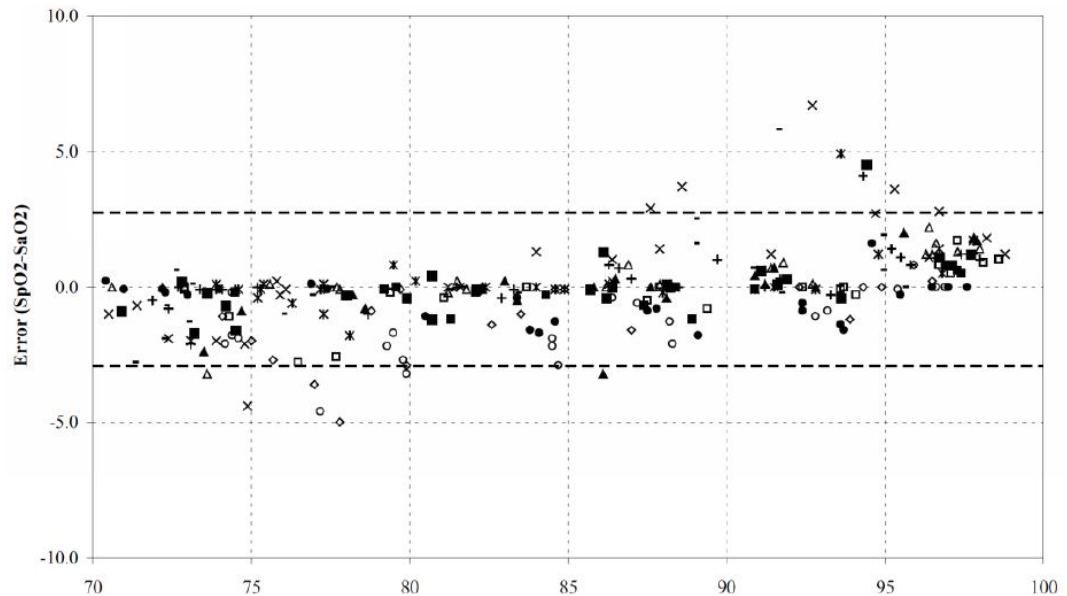
Exposure to high ambient light from surgical lamps (especially those with a xenon light source), bilirubin lamps, fluorescent lights, infrared heating lamps, or direct sunlight can affect the accuracy of oximetry readings. To prevent interference from ambient light, ensure that the sensor is properly applied. If necessary, cover the sensor with opaque material.

Do not attempt to recycle, recondition or reprocess disposable sensors or patient cables. This could damage the electrical components, leading to patient harm.

## SpO<sub>2</sub> Accuracy Specifications

Accuracy testing for SpO<sub>2</sub> was performed on healthy adult subjects. The tables below provides A<sub>RMS</sub> (Accuracy Root Mean Square) values measured using the Masimo Rainbow SET Technology.

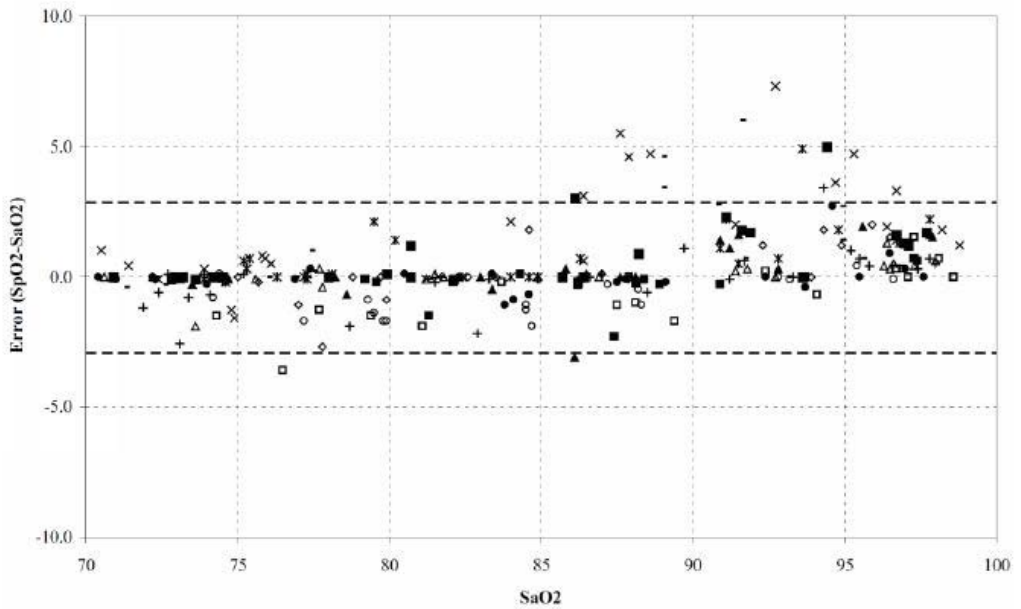
### Masimo LNCS Sensors, Adult and Pediatric



MEASURED $A_{RMS}$ VALUES	
Range	$A_{RMS}$
90-100%	1.64%
80-90%	1.07%
70-80%	1.55%

Overall Claimed Accuracy Value	
Range	$A_{RMS}$
70-100%	$\pm 2\%$

**Masimo LNCS Sensors, Infant, Neonate, and Neonate (Pre-Term)**

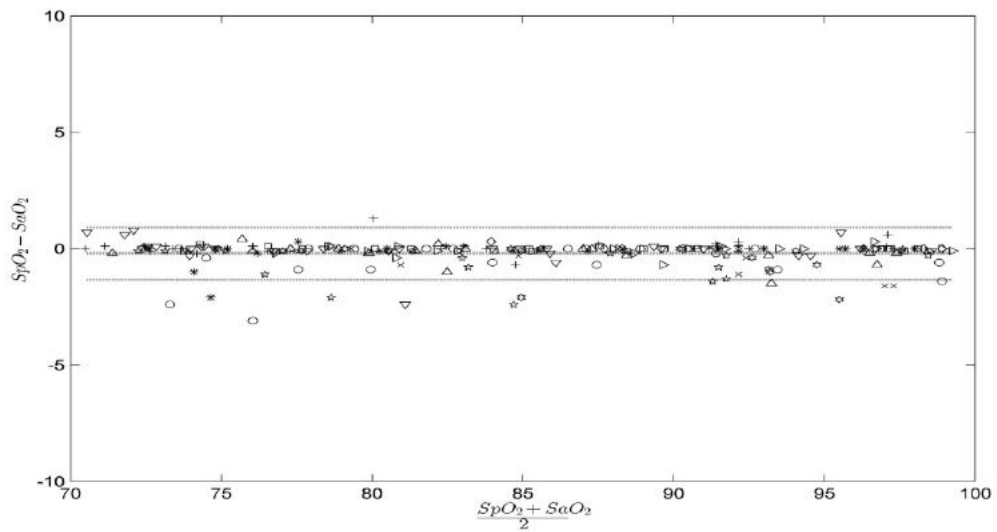


MEASURED $A_{RMS}$ VALUES	
Range	$A_{RMS}$
90-100%	1.85%
80-90%	1.44%
70-80%	0.89%

Overall Claimed Accuracy Value			
Range	A <sub>RMS</sub>		
	Inf	Neo*	Neo Pt*
70-100%	± 2%	± 2% Adult ± 3% Neonatal	± 3%

\*The saturation accuracy of the Neonate and Preterm sensors were validated on adult volunteers and 1% was added to account for the properties of fetal hemoglobin.

**Masimo DCI/DCIP Sensors**



MEASURED A <sub>RMS</sub> VALUES	
Range	A <sub>RMS</sub>
90-100%	0.60%
80-90%	0.54%
70-80%	0.67%

Overall Claimed Accuracy Value	
Range	A <sub>RMS</sub>
70-100%	± 2 %



## Selecting a Sensor and Cable

When selecting a sensor, consider the patient's weight, the adequacy of perfusion, the available sensor sites, and the anticipated duration of monitoring. For more information, refer to the following table or contact ZOLL Medical Corporation. Select an appropriate sensor, apply it as directed, and observe all warnings and cautions presented in the *Directions for Use* accompanying the sensor.

Sensor	Type	Patient Weight
LNCS Aadx	Single Use	Adults > 30 kg
LNCS Pdx	Single Use	Pediatrics and Slender Adults 10 - 50 kg
LNCS Neo-L	Single Use	Neonates < 3 kg
LNCS NeoPt-L	Single Use	Neonates < 1 kg
LNCS Inf-L	Single Use	Infant 3 - 20 kg
LNCS DCI	Reusable	Adults and Pediatrics > 30 kg
LNCS DCIP	Reusable	Pediatrics 10 - 50 kg

ZOLL offers two reusable patient cables for use with Masimo oximeter sensors.

ZOLL Part Number	Item
8000-0298	4 foot (1.2 m) patient cable
8000-0293	10 foot (3.0 m) patient cable

## Selecting a Sensor Application Site

Choose a site that is well perfused and restricts a conscious patient's movements the least. The ring finger or middle finger of the nondominant hand is preferred.

Alternatively, you can use the other digits on the nondominant hand. Be sure the sensor's detector is fully covered by flesh. You can use the great toe or long toe (next to the great toe) on restrained patients or patients whose hands are unavailable.

To prevent interference from ambient light, ensure that the sensor is properly applied, and cover the sensor site with opaque material, if required. Failure to take this precaution in high ambient light conditions may result in inaccurate measurements.

Do not select an SpO<sub>2</sub> sensor site on the same arm/leg as an NIBP cuff. Inflation of the cuff will cause the SpO<sub>2</sub> values to read incorrectly.

## Applying a Reusable DCI Sensor

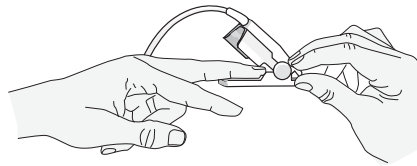
**Note:** These instructions describe how to apply a reusable DCI sensor. For all other reusable sensors, refer to the sensor packaging for application instructions.

**Note:** The reusable sensor is not intended for use on the thumb or across a child's hand or foot.

Select a monitoring site (see previous section), then apply the reusable DCI sensor as follows:

1. Place the selected digit over the sensor window, making sure that the sensor cable runs over the top of the patient's hand.

The fleshiest part of the digit must cover the photodetector window in the lower half of the DCI sensor.

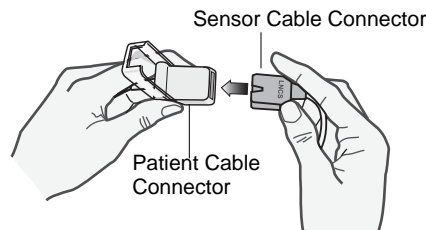


2. On finger sites, make sure the tip of the finger touches the raised digit stop inside the sensor. If the fingernail is long, it may extend over and past the finger stop.

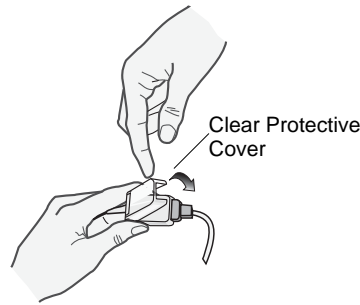


**Note:** With smaller digits, the digit may not need to be pushed all the way to the stop to completely cover the detector window.

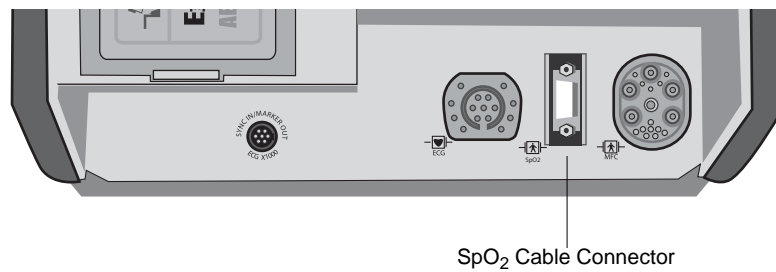
3. Check the sensor position to ensure that the top and bottom halves of the DCI sensor are parallel. To ensure accurate data, you must have complete coverage of the detector window (see previous figure).
4. Lift the clear plastic protective cover from the female end of the patient cable, then plug the sensor cable's male connector all the way into the patient cable connector.



5. Lower the clear plastic protective cover over the connection to secure it.



6. Connect the SpO<sub>2</sub> patient cable to the SpO<sub>2</sub> connector on the rear panel of the R Series unit.



## Applying a Single-Use Sensor

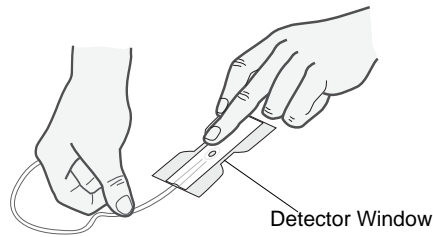
You can use a disposable LNCS sensor for SpO<sub>2</sub> monitoring. Do not wrap the adhesive too tightly as this can cause venous pulsations that could lead to inaccurate saturation measurements.

You can reapply a disposable sensor to the same patient if the emitter and photodetector windows are clear and the adhesive still adheres to the skin. To rejuvenate the adhesive, wipe it with an alcohol pad and then allow the sensor to thoroughly air dry before placing it on the patient.

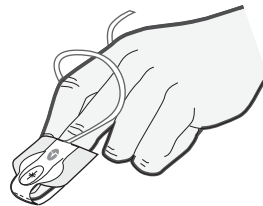
**Note:** LNCS Aidx sensors are not intended for use across a child's hand or foot. For instructions on proper application of neonatal sensors, refer to the *Directions for Use* included with each LNCS sensor.

1. Open the pouch and remove the sensor.
2. Holding the sensor with the tan printed side downward, bend the sensor backward and remove the backing material.

3. Orient the sensor so that the digit can be attached to the detector side of the sensor first.

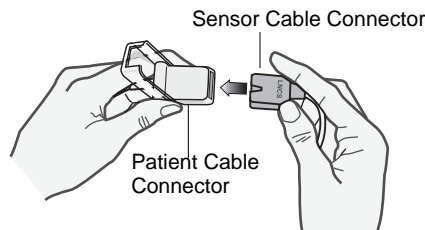


4. Press the detector onto the fleshy part of the finger near the tip of the finger. To ensure accurate data, you must have complete coverage of the detector window.
5. With the emitter positioned over the fingernail, secure the wings around the finger.

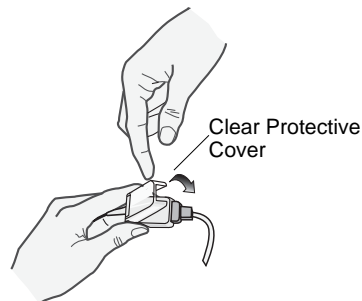


When positioned properly, the:

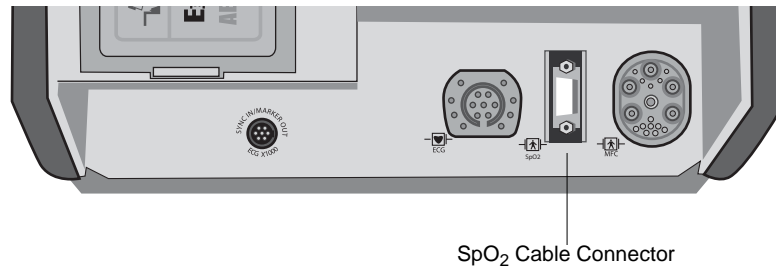
- emitter and photodetector are vertically aligned
  - digit completely covers the photodetector window
  - connector tab is located on the top side of the finger
6. Lift the clear plastic protective cover from the female end of the patient cable, then plug the sensor cable's male connector all the way into the patient cable connector.



7. Lower the clear plastic protective cover over the connection to secure it.



8. Connect the SpO<sub>2</sub> patient cable to the SpO<sub>2</sub> connector on the rear panel of the R Series unit.



## Cleaning and Reuse of Sensors

Reusable sensors can be cleaned as follows:

1. Disconnect the sensor from the patient cable.
2. Wipe the entire sensor clean with a 70% isopropyl alcohol moistened pad.
3. Allow the sensor to air dry before returning it to use.

## Cleaning and Reuse of Patient Cables

Patient cables can be cleaned as follows:

1. Disconnect the sensor from the patient cable (if attached).
2. Disconnect the cable from the rear of the R Series unit.
3. Wipe the cable clean with a 70% isopropyl alcohol moistened pad.

Allow the cable to dry before using it.

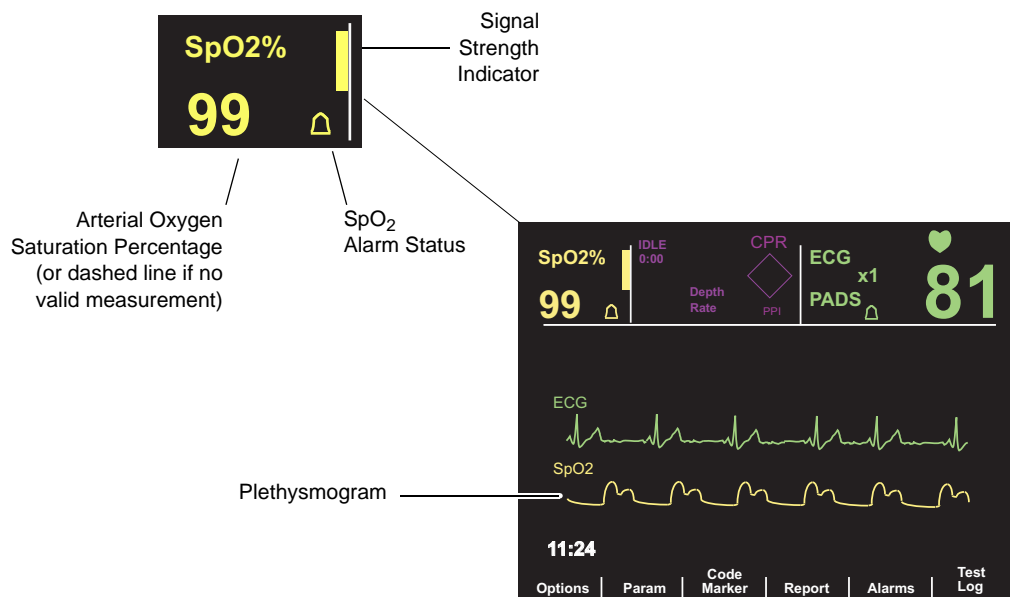
## How SpO<sub>2</sub> Information is Displayed

The R Series pulse oximeter displays the following information in the SpO<sub>2</sub> area:

- SpO<sub>2</sub> value (arterial oxygen saturation percentage)
- SpO<sub>2</sub> alarm indicator
- Signal strength indicator (the bar rises and falls to indicate the relative change in the pulsatile signal)

The display optionally includes the normalized plethysmogram below the ECG trace. The R Series pulse oximeter calculates oxygen saturation and updates the display once per second.

**Note:** If you are using the Plus or BLS models, you will see the SpO<sub>2</sub> value, the alarm indicator, and the signal strength indicator while in AED or Manual mode. To see the normalized plethysmogram, the unit must be in Manual mode.



## Monitoring a Patient

To set up the pulse oximeter:

1. Attach the sensor to the patient, and plug the sensor cable into the patient cable (refer to “Applying a Reusable DCI Sensor” on page 9 or “Applying a Single-Use Sensor” on page 10.)
2. Ensure the patient cable is connected to the unit.
3. Turn the Mode Selector to the following:
  - MONITOR for ALS models.
  - ON for Plus or BLS models. Press the **Manual Mode** softkey, and then the **Confirm** softkey to enter the Manual mode of operation.

When the unit obtains measurements for arterial oxygen saturation, numeric values replace the dashed lines on the display.

4. If the pulse indicator shows a weak signal, check the oximeter sensor or apply it to a more appropriate site.

If necessary, enable SpO<sub>2</sub> alarms and adjust the alarm limits. Refer to “Setting SpO<sub>2</sub> Alarms” on page 16.

**Note:** If ECG leads are not attached to the patient, the unit uses SpO<sub>2</sub> pulse measurements for displaying the heart rate (HR) in the ECG area. In this case, the heartbeat indicator does not flash.

**Note:** If the unit displays the message *SPO2 COMM ERROR* shortly after powering on, the SpO<sub>2</sub> monitoring subsystem has failed. Contact ZOLL Technical Service.

## Adjustable SpO<sub>2</sub> Settings

The pulse oximeter includes several settings which you can adjust when the unit is in clinical mode:

- Sensitivity level
- Measurement averaging period
- Plethysmogram display
- SpO<sub>2</sub> alarm state and limits (SpO<sub>2</sub> and pulse rate)

Any change you make to one of these settings remains in effect until changed again or until the unit is turned off for at least 10 seconds. When restarted, the unit reinstates its configured default settings, which can differ from the factory defaults. (For the factory default values, refer to “Default Settings for the SpO<sub>2</sub> Option” on page 17.)

To access the SpO<sub>2</sub> monitoring functions:

1. Turn the Mode Selector to the following:
  - MONITOR for ALS models.
  - ON for Plus or BLS models. Press the **Manual Mode** softkey, and then the **Confirm** softkey to enter the Manual mode of operation.
2. Press the **Param** softkey.

Softkey labels for the SpO<sub>2</sub> functions appear: **Sens** (used to adjust the SpO<sub>2</sub> sensitivity), and **Average** (used to adjust the SpO<sub>2</sub> averaging period). Follow instructions in the two subsequent sections.

## Setting the SpO<sub>2</sub> Sensitivity

The **Sens** softkey allows you to select either Normal or High sensitivity for SpO<sub>2</sub> monitoring. Normal sensitivity is recommended for most patients.

Under very low perfusion conditions, such as severe hypotension or shock, high sensitivity might provide more accurate measurements.

**Note:** With high sensitivity, SpO<sub>2</sub> measurements are more easily contaminated by artifact; carefully and continuously observe the patient.

To set the SpO<sub>2</sub> sensitivity level:

1. Press the **Sens** softkey.  
The **Normal** and **High** softkeys appear.
2. Press the softkey for the preferred SpO<sub>2</sub> sensitivity, then press the **Return** softkey.

## Setting the SpO<sub>2</sub> Averaging Period

The R Series provides three different time periods over which SpO<sub>2</sub> values are averaged:

- 4 seconds
- 8 seconds (factory default)
- 16 seconds

The averaging period is rarely changed from the 8-second default setting. For high-risk patients with rapidly changing SpO<sub>2</sub> conditions, use 4-second averaging. The 16 second setting should be used only when the 8-second setting (default) is inadequate due to extremely high artifact conditions.

To set the SpO<sub>2</sub> averaging period:

1. Press the **Average** key.  
The following softkeys appear: **4 secs, 8 secs, 16 secs**.
2. Press the softkey for the preferred averaging period, then press the **Return** softkey.

## Displaying the Plethysmogram

When pulse oximetry is in use, the unit can display a plethysmogram below the ECG in either the second or third trace position in MONITOR and DEFIB mode (for ALS models) or ON mode (for Plus and BLS models), or in the second trace position in PACER mode (for all models).

The amplitude of the plethysmogram remains constant for all saturation levels (see the *R Series Operator's Guide* for instruction on how to adjust the amplitude of the waveform using the SIZE button). The shape of the waveform itself is variable.

To display or remove the plethysmogram:

1. From one of the following modes:
  - MONITOR, DEFIB or PACER mode for ALS models
  - ON or PACER mode for Plus or BLS models
2. Press the **Options** softkey.
3. Press **Traces**.
4. Press **Trace 2** in PACER mode, or press either **Trace 2** or **Trace 3** in DEFIB or MONITOR mode (for ALS models) or ON mode (for Plus or BLS models) to select the position.
5. To display the plethysmogram in the selected position, press **SpO<sub>2</sub>**. To remove the trace from the display, press **Off**.
6. When you are finished, press **Return** twice to return to the main menu.

The third waveform disappears in DEFIB mode (for ALS models) or ON mode (for Plus or BLS models) under the following conditions:

- When the **CHARGE** button is pressed
- When the **ANALYZE** button is pressed
- When the **ENERGY SELECT** button is pressed
- While synchronization is enabled



## Setting SpO<sub>2</sub> Alarms

The R Series pulse oximeter provides operator-programmable alarms for arterial oxygen saturation and pulse rate. These are high-priority alarms, indicated visually by flashing the associated bell symbol and parameter values and audibly by a continuous tone.

**Note:** Once the arterial oxygen saturation reaches the high or low limit, there is a 4 second delay until the alarm occurs.

For the low and high alarm limit ranges and factory default values, refer to “Specifications” on page A-1 of your defibrillator’s *R Series Operator’s Guide*.

**Note:** When monitoring heart rate via pulse oximetry rather than ECG electrodes, the tachycardia alarm limit is automatically lowered to 235 if it was previously set to a higher value. The unit restores the higher setting when ECG monitoring resumes.

### SpO<sub>2</sub> Automated Alarm Limits

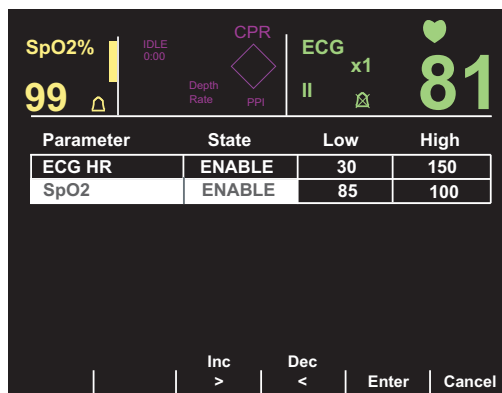
When the SpO<sub>2</sub> alarm state is set to AUTO, the unit calculates the low and high limits for arterial oxygen saturation as follows:

SpO <sub>2</sub> Alarm Limit (AUTO State)	Calculation
Low	95% of the patient’s current saturation measurement
High	105% of the patient’s current saturation measurement (up to 100%)

To use AUTO alarm limits, ensure that the unit is making valid SpO<sub>2</sub> measurements from the patient.

To set SpO<sub>2</sub> alarm limits:

- Using the procedure “Setting Alarms for Monitored Parameters” in your defibrillator’s *R Series Operator’s Guide*, select the parameter SpO<sub>2</sub>.



- Follow procedures in the Alarm section of your defibrillator’s *R Series Operator’s Guide* to enable or disable processing and/or set alarm limits.

For information on configuring different alarm default values, refer to the *R Series Configuration Guide*.

## Weekly Test Procedure

Perform the following procedure weekly to ensure that the pulse oximeter is functioning properly.

Use a reusable oximeter sensor for this procedure and test the pulse oximeter as follows:

1. Attach a reusable SpO<sub>2</sub> sensor to your finger and connect the patient cable to the SpO<sub>2</sub> connector.
2. Turn the Mode Selector to the following:
  - MONITOR for ALS models.
  - ON for Plus or BLS models. Press the **Manual Mode** softkey, and then the **Confirm** softkey to enter the Manual mode of operation.

The monitor displays the pulse signal indicator and the arterial oxygen saturation percentage.

3. Manually measure your pulse and compare it with the displayed pulse rate.  
The displayed pulse rate should be comparable to your measured pulse.
4. Observe the plethysmogram and verify that the wave repeats at the pulse rate.  
If the unit is not displaying the waveform, refer to “Displaying the Plethysmogram” on page 15.
5. With SpO<sub>2</sub> alarms enabled, raise the low SpO<sub>2</sub> limit to generate an alarm, suspend the alarm tone, and then reset the low limit. (For instructions, refer to “Setting SpO<sub>2</sub> Alarms” on page 16.)  
When the alarm occurs, the unit emits a continuous alarm tone, highlights the SpO<sub>2</sub> value, and flashes the associated bell symbol.
6. Lower the high SpO<sub>2</sub> limit to generate an alarm, suspend the alarm tone, and then reset the high limit. (For instructions, refer to “Setting SpO<sub>2</sub> Alarms” on page 16.)  
When the alarm occurs, the unit emits a continuous alarm tone, highlights the SpO<sub>2</sub> value, and flashes the associated bell symbol.
7. Remove the sensor from your finger without disconnecting the patient cable.  
The unit emits two beeps and displays the message: *CHECK SPO2 SENSOR*.
8. Replace the sensor on your finger and wait for the SpO<sub>2</sub> value to reappear.
9. Unplug the patient cable from the unit.  
The unit emits two beeps and displays the message: *CHECK SPO2 SENSOR*.

## Default Settings for the SpO<sub>2</sub> Option

The table below lists the factory default settings for SpO<sub>2</sub> monitoring and the range of values available for each parameter. Unless changed by the user, these default settings will always

appear after the unit is powered-up. See the *R Series Configuration Guide* for instructions on changing power-up defaults.

Parameter	Factory Default Setting	Possible Values
Averaging period	8 seconds	<ul style="list-style-type: none"> <li>4 seconds</li> <li>8 seconds</li> <li>16 seconds</li> </ul>
Sensitivity level	Normal	<ul style="list-style-type: none"> <li>Normal</li> <li>High</li> </ul>
SpO <sub>2</sub> low saturation limit	85%	50% to 100% or OFF
SpO <sub>2</sub> high saturation limit	OFF (appears as: ---)	50% to 100% or OFF
Low Heart Rate Alarm Limit	30 beats per minute	20 to 100 beats per minute
High Heart Rate Alarm Limit	150 beats per minute	60 to 280 beats per minute (ECG) 60 to 235 beats per minute (SpO <sub>2</sub> )

## SpO<sub>2</sub> Accessories

The following table describes each of the SpO<sub>2</sub> accessories.

Item	Description	REF
LNCS Adtx	Single use sensor for Adult patients > 30 kg	8000-0320
LNCS Pdtx	Single use sensor for Pediatrics and Slender Adults 10 - 50 kg	8000-0321
LNCS Inf-L	Single use sensor for Infants 3 - 20 kg	8000-0322
LNCS Neo-L	Single use sensor for Neonates < 3 kg	8000-0323
LNCS NeoPt-L	Single use sensor for Neonates < 1 kg (Pre-term)	8000-0324
LNCS DCI	Reusable sensor for Adults and Pediatrics > 30 kg	8000-0294
LNCS DCIP	Reusable sensor for Pediatrics 10 - 50 kg	8000-0295
LNC-4	4' Reusable Patient Cable	8000-0298
LNC-10	10' Reusable Patient Cable	8000-0293
LNC Ext	LNC Extension Cable, DB-9 Termination, 4ft	8000-0325
LNCS-to-LNOP	Adapter Cable, LNCS Sensor to LNOP Patient Cable	8000-0327
LNOP DC-12	LNOP Adult Reusable Direct Connect 12' Cable	8000-0296

## Messages and Troubleshooting

Message or Symptom	Possible Causes	Recommended Action
<i>SPO2 AMBIENT LIGHT</i>	Excessive ambient light	Relocate the sensor, reduce the ambient light, or shield the sensor from the light.
<i>SPO2 PULSE SEARCH</i>	Sensor cannot detect a pulse.	Normal behavior immediately after applying the sensor. If this message persists beyond 10 seconds, reposition or relocate the sensor, or increase perfusion.

Message or Symptom	Possible Causes	Recommended Action
<i>CHECK SPO2 SITE</i>	Insufficient perfusion at the sensor site	Reposition or relocate the sensor, or increase perfusion.
<i>CHECK SPO2 SENSOR</i>	An inappropriate sensor site, poor application of the sensor, no patient cable plugged in, or motion is causing invalid SpO <sub>2</sub> readings.	Reposition or relocate the sensor, or increase perfusion.  Ensure that the cable is plugged into the unit.  Cease motion.
Dashes appear in place of the SpO <sub>2</sub> saturation percentage.	Excessive ambient light, inadequate perfusion, high signal artifact, or a defective or disconnected sensor or patient cable	Reposition or relocate the sensor, reduce the ambient light, shield the sensor from the light, or increase perfusion.  Check the cable and sensor.
Message: <i>SPO2 COMM ERROR</i>	The pulse oximeter subsystem is not communicating with the defibrillator.	Turn unit off and then back on to see if message clears. If message persists, contact ZOLL Technical Service.

## Specifications

The following specifications apply to the R Series pulse oximeter only. For information about the R Series defibrillator and batteries, refer to your defibrillator's *R Series Operator's Guide*.

General	
Saturation range (%SpO <sub>2</sub> )	1% to 100%
Saturation resolution	1%
Saturation accuracy *  <b>Note:</b> R Series defibrillators are designed to work with the Masimo LNCS series of sensors and are dependent on their specifications. Refer to Masimo LNCS sensor labeling for accuracy information.	<p><u>During no-motion conditions</u></p> <p>Adults/pediatrics: 70% to 100%, ±2% 0% to 69%, unspecified</p> <p>Neonates: 70% to 100%, ±3% 0% to 69%, unspecified</p> <p><u>During motion conditions</u></p> <p>All patients: 70% to 100%, ±3% 0% to 69%, unspecified</p>
Saturation alarm limits	On/Off displayed on monitor; operator-selectable.  Low limit: 70% to 98% High limit: 72% to 100%
SpO <sub>2</sub> Wavelength *  <b>Note:</b> Information about wavelength range can be especially useful to clinicians.	Nominal Red LED Wavelength: 660 nanometers Nominal Infrared LED Wavelength: 905 nanometers
Energies (Radiant Power) of light for LNCS Sensors at 50 mA pulsed	Minimum: 0.13 mW Maximum: 0.79 mW

Pulse rate range	25 to 240 beats per minute
Pulse rate resolution	1 beat per minute
Pulse rate accuracy	<u>During no-motion conditions</u> 25 to 240 beats per minute, $\pm 3$ beats per minute <u>During motion conditions</u> 25 to 240 beats per minute, $\pm 5$ beats per minute
Pulse rate alarm limits	On/Off displayed on monitor; operator-selectable. Low limit: 20 to 100 beats per minute High limit: 60 to 235 beats per minute
Biocompatibility	Patient-contacting material meets requirements of ISO 10993-1, Biological Evaluation of Medical Device, Part I, for external surfaces, intact surfaces, and short-term exposure.
<b>Environmental</b>	
Temperature	Operating: 0°C to 40°C Storage and shipping: -20°C to 60°C <b>Note:</b> The defibrillator might not perform to specifications if stored at the upper or lower temperature extreme and then put to immediate use.
Electromagnetic immunity	EN60601-2-4; IEC 1000-4-3 to 18 V/m
Software Hazards	Minimized by compliance with EN14971

**Note:** The Pulse Oximetry Option is calibrated for functional saturation.

**Note:** Because R Series pulse oximeter measurements are statistically distributed, only about 68% of these measurements can be expected to fall within plus or minus one standard deviation of the value measured by a CO-oximeter.

\* The accuracy of the R Series pulse oximeter can only be verified by comparing its measurements to those obtained with a CO-oximeter. Pulse oximeter functional testers cannot be used to verify the accuracy of the oximeter or its sensors.



**ZOLL**<sup>®</sup>

R Series<sup>®</sup>  
Non-Invasive Blood Pressure  
(NIBP)

The issue date for the R Series Non-Invasive Blood Pressure guide (REF 9650-0914-01 Rev. C) is December, 2017.

Copyright © 2017 by ZOLL Medical Corporation. All rights reserved. ZOLL and R Series are trademarks or registered trademarks of ZOLL Medical Corporation.

SunTech Advantage is a registered trademark of SunTech Medical Group.

All other trademarks and registered trademarks are property of their respective owners.



## Non-Invasive Blood Pressure Monitoring (NIBP) Indication of Use

The R Series system is indicated for the non-invasive measurement of arterial blood pressure for resting patients in critical care and in-hospital transport. The NIBP feature is indicated to measure blood pressure for patients from newborn (neonate) to adult.

### NIBP Contraindications for Use

There are no known contraindications for the use of the NIBP monitor.

### General Information

Federal (U.S.A.) law restricts this defibrillator to sale by or on the order of a physician.



# Non-Invasive Blood Pressure (NIBP)

---

## Product Description

The Non-Invasive Blood Pressure (NIBP) option on the R Series<sup>®</sup> unit gives you the ability to take a single blood pressure measurement, STAT measurements (automatically repeated measurements over a 5 minute period), or automatic measurements at repeating pre-selected intervals. The blood pressure information (including the patient's systolic, diastolic and mean blood pressure values) is shown on the R Series monitor in the NIBP display area, on the left side of the screen.

For R Series BLS/Plus models, the NIBP option can only be used while the unit is in Manual mode.

## How To Use This Manual

This insert describes how to set up and use the R Series NIBP option. Important safety information relating to the general use of the R Series NIBP option appears in "Safety Considerations" on page 2.

Before attempting to use the NIBP option, you must read and understand all the information contained in the *R Series Operator's Guide*, which provides information that operators need for the safe and effective use and care of the R Series unit.

Thoroughly read the Safety Considerations and Warnings sections in both the *R Series Operator's Guide* and the relevant inserts before operating your R Series product.

## SunTech CE Contact

Direct all cuff, hose, and NIBP questions with regards to the Declaration of Conformity with European Union Directives to the authorized representative for SunTech:

SunTech Medical Instruments Ltd.  
Oakfield Industrial Estate  
Stantom Harcourt Road  
Eynsham, Witney  
OX8 ITS  
UK

## Safety Considerations

### General NIBP Safety



- Read the *R Series Operator's Guide* and this manual insert before use.
- Ensure that the R Series NIBP option is operated by qualified personnel only.
- Consult a physician for the proper interpretation of pressure measurements.
- Do not use on patients known to be susceptible to bruising.
- Use caution when using on elderly hypertensive patients, as such patients may be more susceptible to bruising.
- Route patient hoses carefully to avoid patient entanglement, strangulation or compression of hose.
- Do not select a cuff inflation pressure that exceeds the patient's expected systolic pressure by more than 30-40 mmHg (4.0-5.3 kPa). The factory-installed default adult cuff inflation pressure is 160 mmHg (21.3 kPa) for adult patients, 120 mmHg (16.0 kPa) for pediatric patients, and 90 mmHg (12.0 kPa) for neonatal patients.
- Keep patient, hose and cuff as still as possible during measurement. Patient movement or vibrations from outside sources, particularly moving vehicles, can degrade measurement accuracy.
- Check patient regularly for signs of skin irritation or impaired circulation in the monitored limb.
- Do not use the NIBP option on a patient when the R Series unit is connected to an ECG simulator.
- If an alarm occurs while the audible alarm indicators are disabled, alarms do not sound; rather only the visual alarm indicators are displayed.
- If the accuracy of measurements is suspect, first check the patient's vital signs by alternate means. Then check the cuff, hose and R Series NIBP option for proper functioning.
- The cuff, hose, and fitting are defibrillation-protected. Using the NIBP option introduces no risk for shock due to defibrillation. The cuff and hose are non-conductive. Using the NIBP option introduces no risk for burns due to electrosurgery.
- Cuff safety and effectiveness have not been proven on pregnant women.
- Do not attach the cuff to a limb being used for IV infusions or any other intravascular access, therapy or an arterio-venous (AV) shunt. The cuff inflation can temporarily block blood flow, potentially causing harm to the patient.
- Applying the cuff over a wound can cause further injury.
- For patients that have had a mastectomy, cuff should be applied to opposite arm.
- Blood pressure measurements can be affected by the position of the patient, physiologic condition, activity level, improper cuff size/application, environment and use outside of the operating instructions detailed in this manual.
- The NIBP module may not operate correctly if used or stored outside the relevant temperature or humidity ranges described in the specifications on page 28.

### Cuff and Hose Safety

- Only use cuffs, hoses, and connectors supplied or specified by ZOLL.
- Ensure that the hose is not kinked or obstructed before taking measurement.

- Do not use damaged cuffs, hoses, or connectors.
- Ensure proper cuff selection and placement to avoid inaccurate measurements or patient injury.
- Position the cuff so it is level with the heart during measurement.
- Do not attach the cuff to a limb being used for IV infusion, SpO<sub>2</sub> monitoring, or other monitoring equipment. Cuff inflation might block the infusion, causing harm to the patient or inaccurate SpO<sub>2</sub> measurements.
- Do not repeat NIBP measurements (particularly STAT measurements) at intervals less than 3-5 minutes over an extended period of time. Rapidly repeating measurement can impair circulation in the monitored limb.
- Do not sterilize or immerse the cuffs or hoses.

---

(This page intentionally left blank.)

---

## NIBP Intended Use

The ZOLL R Series NIBP option is intended to be used for the non-invasive measurement of arterial blood pressure for resting patients in critical care and in-hospital transport.

The R Series NIBP option is designed to measure blood pressure for adult patients (21 years of age and older) and for pediatric patients, as described in the following table:

Pediatric Subpopulation	Approximate Age Range
Newborn (neonate)	Birth to 1 month of age
Infant	1 month to 2 years of age
Child	2 to 12 years of age
Adolescent	12-21 years of age

## What Can I Do With the NIBP Option?

With the NIBP option you can do the following in **MONITOR**, **PACER**, or **DEFIB (ON for BLS/Plus units, then select **Manual**) mode**:

- Take a single blood pressure measurement.
- Take a STAT measurement (as many measurements – up to 10 – as possible within 5 minutes).
- Take repeated measurements at user-programmable intervals.
- Immediately abort any measurement in progress by pressing one button.
- Set the cuff inflation pressure to adjust automatically based on the previously measured systolic value.
- Display systolic, diastolic and mean blood pressure on the screen.
- Configure alarms to go off when the unit detects blood pressure values above or below user-programmable limits.
- Display a history of NIBP measurements taken in the last 4 hours.

## How Do I Use the NIBP Option?

To take safe and accurate blood pressure measurements using the R Series NIBP option, you must perform the following steps, each of which corresponds to a subsequent section in this document. Read each section carefully before you use the R Series NIBP option.


1. Select the proper size cuff.
2. Connect the hose to the R Series unit and to the cuff.
3. Apply the cuff to the patient.
4. Display the NIBP menu.
5. Select the correct patient type (if the current setting is not appropriate).
6. Set the cuff inflation pressure (if the current setting is not appropriate).
7. Configure alarms (if the current settings are not appropriate).
8. Take blood pressure measurement(s).
9. Read the display.

---

**WARNING!** Do not use the NIBP option without proper training. Setting initial inflation pressure too high can result in serious injury to the patient. Patient movement, very low pulse volume, or vibration from outside sources can influence the accuracy of blood pressure measurements.

---

## How Does the NIBP Option Work?

The patient blood pressure cuff and hose connect to the R Series unit through the NIBP connector on the rear panel of the unit. The **NIBP** button (  ) on the front panel of the R Series allows you to initiate and terminate non-invasive blood pressure measurements, whose values display in the NIBP area of the monitor. You can also initiate and terminate Auto or STAT mode measurements using the softkeys on the NIBP menu.

The ZOLL R Series NIBP Option non-invasively measures arterial blood pressure and pulse rate in resting adult, neonate and pediatric patients. By incorporating the SunTech Medical Advantage OEM BP A+ R-wave Motion Tolerance Module into the R Series Defibrillator/Monitor/Pacemaker devices, the option facilitates the ability to monitor and assess the physiological characteristics of the indicated patient populations.

The NIBP module measures the oscillometric pulses transmitted through the blood pressure cuff and hose, and calculates the blood pressure measurements accordingly. The pressure measurement cycle takes approximately 30 seconds and proceeds as follows:

1. The cuff inflates to a preconfigured pressure (configured default value for adult patients is 160 mmHg), above the patient's systolic blood pressure, to occlude blood flow through the arteries in the monitored limb.
2. The cuff deflates incrementally, allowing blood to flow through the cuff and into the monitored limb.
3. As blood flows past the partially deflated cuff, it produces pressure oscillations that are transmitted to the R Series unit through the hose.
4. The R Series unit measures the oscillometric pulses and uses them to calculate the corresponding systolic, diastolic, and mean blood pressure, as well as the patient's pulse rate.
5. The NIBP option automatically adjusts the blood pressure measurement procedure in response to certain error conditions such as:

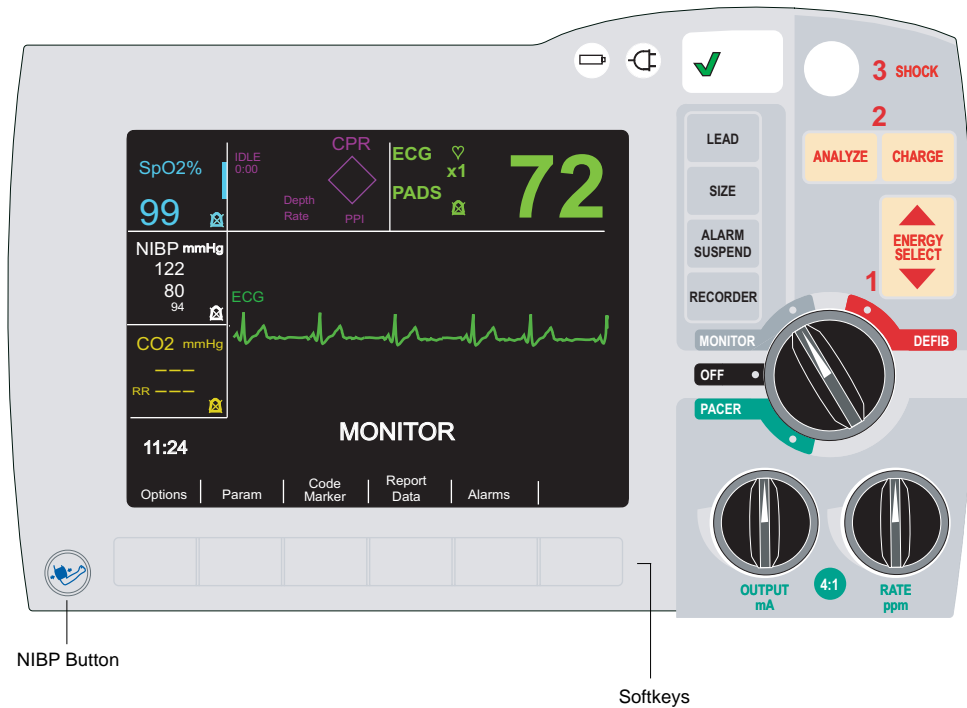
Condition	Adjustment/Response
The unit cannot detect systolic pressure	The unit automatically increases the cuff inflation pressure and completes the blood pressure measurement
The unit cannot detect systolic, diastolic or mean pressure after 3 minutes	The unit aborts the blood pressure measurement and deflates the cuff
The unit detects a fault	The unit displays a corresponding error message on the monitor and aborts the measurement



# How Do I Read the Display?

After each measurement, the NIBP display area displays measured systolic, diastolic, and mean blood pressure values.

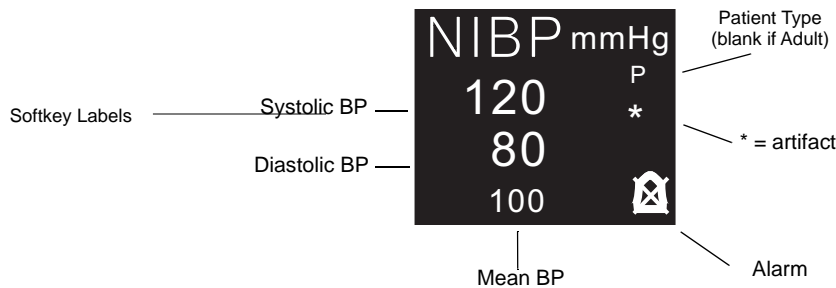
To facilitate quick reaction in emergency situations, you can control certain NIBP features by pressing the NIBP button (👤) at the lower left-hand corner of the unit. To access other NIBP features, you must press a softkey with the appropriate softkey label.



**Note:** Depending on the options included in your R Series unit, your display may differ slightly from the illustrations in this insert.



The NIBP display area on the left side of the monitor screen consists of:

- Symbols that represent the status of blood pressure measurements.
- Numbers that represent the measurement values (refer to the following figure).



When taking a reading, the screen will display only the current cuff pressure.

The symbols below show the current status or action being taken.

Display Symbols	Status
NIBP	Idle, or taking a single measurement
STAT alternating with NIBP	Taking a STAT measurement
AUTO alternating with NIBP	Taking an Auto measurement
	Alarms enabled
	Alarms disabled
P	Pediatric Patient Type
N	Neonatal Patient Type
*	Artifact indicator

The artifact indicator is shown when the R Series unit detects artifact in the signal. Under such circumstances, the displayed pressure values may be inaccurate. Perform additional blood pressure measurements before taking clinical action. If you repeatedly obtain artifact, use alternate techniques to obtain blood pressure prior to taking clinical action.

Note that the R Series default unit of measure is millimeters of mercury (mmHg), but you can configure the R Series to display kilopascals (kPa). Refer to the *R Series Configuration Guide* for information on configuring alternate units of measure.

## Preparing to Take Measurements

The following sections describe how to prepare to take measurements.

### Selecting the Proper Size Cuff

The NIBP option comes with a cuff that inflates to cut off the patient's blood flow and then deflates slowly to allow the blood flow to resume gradually. To take accurate measurements, you must use the proper sized cuff. Bladder length should be at least 80 percent of the limb circumference, while the cuff width should be equal to 40 percent of the limb circumference.

Select the appropriate size cuff for the patient from the following table:

Limb Circumference	Cuff
38 to 50 cm (14.96 to 19.69 in.)	Thigh
31 to 40 cm (12.20 to 15.75 in.)	Large Adult
23 to 33 cm (9.06 to 12.99 in.)	Adult
17 to 25 cm (6.69 to 9.84 in.)	Small Adult
12 to 19 cm (4.72 to 7.48 in.)	Child
8.0 cm to 15.0 cm (3.1 to 5.9 in.)	Neonate #5
7.0 to 13.0 cm (2.8 to 5.1 in.)	Neonate #4
6.0 to 11.0 cm (2.4 to 4.3 in.)	Neonate #3
4.0 to 8.0 cm (1.6 to 3.1 in.)	Neonate #2
3.0 to 6.0 cm (1.2 to 2.4 in.)	Neonate #1

**Caution** You must use the 3 m hose when making neonatal NIBP measurements with the R Series. The 3 m hose (ZOLL Part No. 8000-0662) is standard on R Series units. Do not use the 1.5 m hose when making neonatal NIBP measurements; the cuff may not inflate, causing the unit to abort the NIBP measurement.

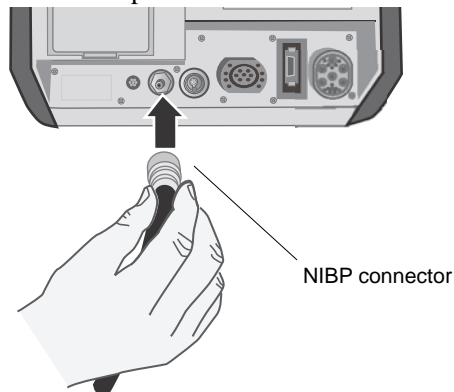
You can order additional cuffs and hoses from ZOLL Medical Corporation. See “NIBP Accessories” on page 24.

## Connecting the Hose

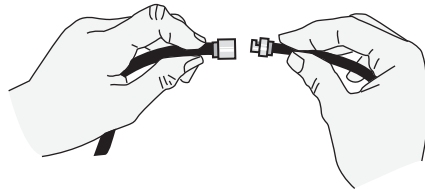
The NIBP option comes with a hose that has a plastic connector on one end and a metal connector on the other end; you must attach the hose to both the R Series unit rear panel using the metal connector and the cuff’s hose using the plastic connector. The cuff has its own short length of hose with a connector on the end. This connector fits into the end of the hose that is not connected to the R Series unit.

To connect the hose:

1. Insert the metal connector on the NIBP hose into the NIBP connector at the back of the R Series unit and push the connector until it snaps into place.



2. Insert the plastic connector on the NIBP hose into the cuff hose connector, and twist the connectors until they lock into place.



You can now apply the cuff to the patient.

## Applying the Cuff to the Patient

Using a cuff that is too small or is loosely applied results in values higher than the patient's actual blood pressure. Using a cuff that is too large results in values lower than the patient's actual blood pressure.

To apply the cuff to the patient:

1. Ensure the patient is sitting or lying down with the limb relaxed, extended, and placed on a smooth surface for support. If the patient is seated, they should have legs uncrossed, feet flat on the floor and back and arms supported. The patient should be comfortable, relaxed as much as possible and not talking during the NIBP measurement.
2. Place the cuff 2 to 5 cm above the elbow crease or 5 to 10 cm (1.9 to 3.9 in.) above the knee crease. The middle of the cuff should be at the level of the right atrium of the heart (heart level).

---

### Caution

Do not place the NIBP cuff on the same arm/leg as an SpO<sub>2</sub> sensor. Inflation of the cuff causes the SpO<sub>2</sub> monitor to read incorrectly. Also, do not attach the cuff to a limb being used for IV infusion. Cuff inflation might block the infusion, causing harm to the patient.

---

**Caution** Ensure that the cuff is at the same level as the right atrium of the heart. If the cuff is located below the patient's right atrium, the blood pressure measurements display false high readings. If the cuff is located above the patient's right atrium, the blood pressure measurements display false low readings.

---

3. Adjust the cuff so that the artery marker on the cuff is over the artery, pointing to the hand or foot.
4. Check that the cuff ends between the range lines marked on the cuff. If not, use a different size cuff.
5. Wrap the deflated cuff snugly around the limb without impeding blood flow.
6. Ensure that the hose is routed to avoid kinking or compression.

You can now access the NIBP features.

## Accessing NIBP Features

Unless you are sure that the NIBP patient type, cuff inflation and alarm settings are appropriate for the patient, display the NIBP menu before you take a blood pressure measurement. When you first turn on the R Series unit, the NIBP settings are at their default values.

While the factory-installed default settings are appropriate for most adult patients, do not assume the settings are at their default. A previous user may have:

- Changed the settings (if you did not turn on the R Series unit).
- Reconfigured the default settings.




Use the default settings unless they are clearly inappropriate for the patient. Any changes to these settings remain in effect until either the settings are again changed, or for 10 seconds after the R Series unit is turned off. If you have not received training on setting NIBP features, do not use the NIBP option.

To facilitate quick reaction during emergency situations, you can directly access many NIBP features without displaying the NIBP menu (see the following table).

---

**WARNING!** Do not start NIBP measurements unless you are sure that the cuff inflation and alarm settings are appropriate for the patient. Incorrect settings can result in patient injury or inaccurate measurements.

---

Task	Action
Taking a single measurement	Press the <b>NIBP</b> button (  ).
Taking STAT measurements	Press and hold the <b>NIBP</b> button (  ) for two seconds (if the NIBP Button Press and Hold configuration option is set to NIBP STAT), or see the next section, “Displaying the NIBP Menu.”
Taking automatic measurements	Press and hold the <b>NIBP</b> button (  ) for two seconds (if the NIBP Button Press and Hold configuration option is set to NIBP AUTO), or see the next section, “Displaying the NIBP Menu.”
Aborting measurement in progress	Press the <b>NIBP</b> button.
Changing NIBP settings	See “Displaying the NIBP Menu” on page 12.

## Displaying the NIBP Menu

Unless it is an emergency situation where quick reaction is essential, you should always check that the cuff inflation and alarm settings are set properly before taking a measurement. You can display the NIBP menu without leaving MONITOR, DEFIB or PACER mode. BLS/Plus units must be in Manual mode to display the NIBP menu.

To display the NIBP menu:

1. Press the **Param** softkey.

If the **Param** softkey label is not displayed, press the **Return** softkey until it is displayed.  
The R Series unit displays the Parameter menu:



2. Press the **NIBP** softkey.

The R Series unit displays the NIBP menu:



- **NIBP Stat:** Take a STAT blood pressure measurement, as many as possible (up to 10) in 5 minutes.
- **NIBP Auto:** Take an automatic blood pressure measurement at regular intervals (the default is 30 minutes)
- **NIBP PT. Type:** Select the patient type of Adult, Pediatric, or Neonatal
- **Settings:** Adjust the settings for Cuff Inflation or Auto Interval.
- **Trend:** View the patient trend data.

## Selecting the Patient Type

On R Series units, you can select a patient type for NIBP measurements: adult, pediatric, or neonate. The patient type setting determines the default cuff inflation pressure, as well as default alarm limits for high/low systolic, diastolic and mean blood pressure values. Unless configured otherwise, the R Series defaults to adult patient mode when initially powered on. See the *R Series Configuration Guide* for more information.

**Note:** When you change the patient type setting, the unit clears any currently displayed NIBP values from the display. You must reinitiate NIBP measurement to display new blood pressure values.

To change the Patient Type setting:

1. Press the **NIBP PT. Type** softkey from the NIBP menu. If the **NIBP PT. Type** softkey label is not displayed, see “Displaying the NIBP Menu” above.

The R Series displays the NIBP Patient menu. The current patient type setting is highlighted.



2. Press the **NIBP Adult**, **NIBP Ped**, or **NIBP Neonate** softkey to select the appropriate patient type setting.

The unit displays a Patient Type indicator in the NIBP display area (“P” for pediatric mode, or “N” for neonatal mode, blank for adult mode), and automatically updates the default cuff inflation pressure and default alarm settings accordingly.

**Note:** If you press the **Return** softkey, the R Series unit returns to the NIBP menu without changing the patient type setting.

## Selecting Cuff Inflation Settings

Before taking a measurement, ensure that the cuff inflation settings are appropriate for the patient. To measure a patient’s blood pressure, the cuff begins the measurement cycle by inflating to a pressure higher than the patient’s systolic blood pressure. This value is called the *cuff inflation pressure*. During an NIBP measurement, the R Series unit may increase the cuff inflation pressure over the initial value to obtain a systolic reading.

By default, the cuff inflation pressure for the first measurement after power-up is set as follows:

- 160 mmHg (21.3 kPa) for adult mode
- 120 mmHg (16.0 kPa) for pediatric mode
- 90 mmHg (12.0 kPa) for neonatal mode

Use the default setting unless it is clearly inappropriate. Any changes to this setting remain in effect until either the setting is changed or 10 seconds after the R Series unit is turned off (returning the setting to its default).

As a safety feature, the cuff can never be inflated to more than 300 mmHg (40.0 kPa) in adult or pediatric mode, and 150 mmHg (20.0 kPa) in neonatal mode.

### Setting Cuff Inflation Pressure

Before taking a measurement, check that the cuff inflation pressure is appropriate for the patient. The cuff inflation pressure options are:

Adult	Pediatric	Neonatal
120 mmHg (16.0 kPa)	80 mmHg (10.7 kPa)	60 mmHg (8.0 kPa)
140 mmHg (18.7 kPa)	90 mmHg (12.0 kPa)	70 mmHg (9.3 kPa)
160 mmHg (21.3 kPa)	100 mmHg (13.3 kPa)	80 mmHg (10.7 kPa)
180 mmHg (24.0 kPa)	110 mmHg (14.7 kPa)	90 mmHg (12.0 kPa)
200 mmHg (26.7 kPa)	120 mmHg (16.0 kPa)	100 mmHg (13.3 kPa)
220 mmHg (29.3 kPa)	130 mmHg (17.3 kPa)	110 mmHg (14.7 kPa)
240 mmHg (32.0 kPa)	140 mmHg (18.7 kPa)	120 mmHg (16.0 kPa)
260 mmHg (34.7 kPa)	150 mmHg (20.0 kPa)	130 mmHg (17.3 kPa)

See the *R Series Configuration Guide* for information on reconfiguring the cuff inflation pressure default setting.

---

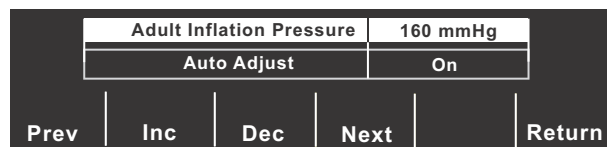
**WARNING! Do not set cuff inflation pressure too high, particularly for neonatal, pediatric, or frail patients. Serious injury can result.**

---

To set the cuff inflation pressure:

1. Press the **Settings** softkey, then the **Cuff Inflation** softkey from the NIBP menu. If the **Cuff Inflation** softkey is not displayed, see “Displaying the NIBP Menu” on page 12.

The R Series unit displays the Cuff Inflation menu:



2. Press the **Next** softkey if “Inflation Pressure” is not highlighted.
3. Press the **Inc** or the **Dec** softkey to select cuff inflation pressure.
4. Press the **Return** softkey to return to the NIBP menu.

The cuff inflation pressure is set.



## Auto Adjust

The R Series unit automatically adjusts the cuff inflation pressure for all subsequent measurements to 30 mmHg (4.0 kPa) greater than the systolic value of the previous measurement. This default setting is called *Auto Adjust*. For example, the cuff inflates to 180 mmHg for the first measurement and the unit obtains a systolic reading of 110 mmHg. For the next measurement, the cuff inflates to 140 mmHg (i.e.,  $110 + 30 = 140$ ).

If the Auto Adjust feature is set to OFF, the selected cuff inflation pressure is used for all measurements. If the Auto Adjust feature is set to ON, the selected cuff inflation pressure is used for the first measurement only.

## Turning Off Auto Adjust

You should turn off the Auto Adjust feature in situations where the R Series unit might inflate the cuff to levels that can cause discomfort or harm to the patient. For example, when the patient is:

- being transported over a very bumpy road
- moving the monitored arm
- a small child

When you turn the Auto Adjust feature off, the R Series unit repeats the same cuff inflation pressure for every measurement. Because this method does not readjust to the patient's previously measured blood pressure, do not use fixed cuff inflation pressures unless you have received the proper training.

To turn off Auto Adjust:

1. Press the **Cuff Inflation** softkey from the NIBP menu.

If the **Cuff Inflation** softkey is not displayed, see "Displaying the NIBP Menu" on page 12.

The R Series unit displays the Cuff Inflation menu:

Adult Inflation Pressure		160 mmHg		
Auto Adjust		On		
Prev	Inc	Dec	Next	Return

2. Press the **Next** softkey until Auto Adjust is highlighted.
3. Press the **Inc** softkey until Auto Adjust is set to OFF:

Adult Inflation Pressure		180 mmHg		
Auto Adjust		Off		
Prev	Inc	Dec	Next	Return

4. Press the **Return** softkey to return to NIBP menu.

The R Series unit repeats the selected cuff inflation pressure for every measurement.

## Setting Alarms

The R Series NIBP option includes blood pressure alarms for the measurements shown in the following table.

Before taking a measurement, ensure that all the NIBP alarms settings are appropriate for the situation. See the *R Series Operator's Guide* for instructions on setting alarms. When an NIBP or heart rate alarm is triggered, the unit automatically initiates a single blood pressure measurement. See the *R Series Configuration Guide* for instructions on how to enable/disable this automatic measurement.

Patient Type	Alarm Parameter		Default Setting	Range (increments of 5)
Adult	Systolic	High	160 mmHg (21.3 kPa)	80-260 mmHg (10.7-34.7 kPa)
		Low	90 mmHg (12.0 kPa)	40-140 mmHg (5.3-18.7 kPa)
	Diastolic	High	110 mmHg (14.7 kPa)	50-200 mmHg (6.7-26.7 kPa)
		Low	50 mmHg (6.7 kPa)	25-100 mmHg (3.3-13.3 kPa)
	Mean	High	130 mmHg (17.3 kPa)	60-220 mmHg (8.0-29.3 kPa)
		Low	60 mmHg (8.0 kPa)	30-120 mmHg (4.0-16.0 kPa)
Pediatric	Systolic	High	145 mmHg (19.3 kPa)	80-160 mmHg (10.7-21.3 kPa)
		Low	75 mmHg (10.0 kPa)	35-140 mmHg (4.7-18.7 kPa)
	Diastolic	High	100 mmHg (13.3 kPa)	50-130 mmHg (6.7-17.3 kPa)
		Low	35 mmHg (4.7 kPa)	20-100 mmHg (2.7-13.3 kPa)
	Mean	High	110 mmHg (14.7 kPa)	60-140 mmHg (8.0-18.7 kPa)
		Low	50 mmHg (6.7 kPa)	30-120 mmHg (4.0-16.0 kPa)
Neonate	Systolic	High	100 mmHg (13.3 kPa)	60-130 mmHg (8.0-17.3 kPa)
		Low	50 mmHg (6.7 kPa)	25-120 mmHg (3.3-16.0 kPa)
	Diastolic	High	70 mmHg (9.3 kPa)	30-105 mmHg (4.0-14.0 kPa)
		Low	30 mmHg (4.0 kPa)	20-100 mmHg (2.7-13.3 kPa)
	Mean	High	80 mmHg (10.7 kPa)	35-110 mmHg (4.7-14.7 kPa)
		Low	35 mmHg (4.7 kPa)	30-105 mmHg (4.0-14.0 kPa)

When the R Series unit is turned on, all alarm functions are disabled, and the alarm limits are set to their default values for the selected patient type. Any changes to these settings remain in effect until either the settings are changed for the patient type or for 10 seconds after the R Series unit is turned off. You can configure the default alarm limits at power-up; see the *R Series Configuration Guide* for more information.

### Setting Alarm Limits

You can change all the alarm limits using standard R Series procedures. See the *R Series Operator's Guide* for instructions on setting alarm limits.

You can set the alarm limits using the Auto function, or you can choose your own limits (see the preceding table). The Auto function sets the high limit to 30 mmHg (4.0 kPa) above and the low limit to 20 mmHg (2.7 kPa) below the last measurement.

### **Enabling, Disabling, and Suspending Alarms**

You can activate and deactivate all NIBP alarms, as well as disable audible NIBP alarm indicators, using standard R Series procedures; refer to the *R Series Operator's Guide* for instructions.

Changing the status of one NIBP alarm automatically sets all the other NIBP alarms to the same status. For example, if you enable the systolic alarm, all other NIBP alarms are automatically activated. Similarly, if you deactivate the diastolic alarm, all other NIBP alarms are automatically deactivated. Activating or deactivating NIBP alarms or disabling audible NIBP alarm indicators does not affect the status of other R Series alarms.

Suspending an NIBP alarm disables the audible indicators until after the completion of the next measurement. All visual alarm indicators remain active.

### **Triggering NIBP Measurements**

You can configure the R Series unit to take a single NIBP measurement after the heart rate alarm is triggered and/or the NIBP alarm is triggered. See the *R Series Configuration Guide* for further details.

## **Setting Motion Tolerance**

You can configure the R Series unit to compensate for motion tolerance during patient movement, such as on a moving stretcher. The motion tolerance option is not supported for neonatal patients. See the *R Series Configuration Guide* for details on how to change this setting.

## **Taking Measurements**

This section describes how to take each type of measurement (a single measurement, a STAT measurement, or an automatic measurement). You can take any type of measurement whether you are in MONITOR, DEFIB or PACER mode (ON for BLS/Plus models, in Manual mode only) except in the following cases:

- The defibrillator is charged or charging.
- The previous measurement occurred within 30 seconds in automatic interval measurement mode.

To immediately abort any measurement in progress and deflate the cuff, press the NIBP button. As a safety feature, the R Series unit does not take measurements within 30 seconds of another completed measurement when in automatic interval measurement mode.

If the R Series unit finds a fault, a message displays on the screen. See “Troubleshooting” on page 26 for a list of NIBP display messages and their corresponding corrective action.

**WARNING!** If the R Series unit takes a measurement but detects the presence of artifact in the signal (denoted by “\*” in the NIBP display area), the measurement may not be accurate. Under such circumstances, perform additional blood pressure measurements. If you repeatedly obtain artifact, use alternate techniques to determine blood pressure prior to taking clinical action.

---


When reading the blood pressure values on the display, keep in mind that the following conditions can influence NIBP measurements:

- Position of the patient
- Position of the cuff relative to the patient’s heart
- Physical condition of the patient
- Patient limb movements
- Convulsions or tremors
- Very low pulse volumes
- Premature ventricular beats
- Vibrations in the cuff or hose caused by moving vehicles
- Improper cuff size or application

**WARNING!** Do not begin NIBP measurements unless the patient type setting is appropriate for the patient. Taking NIBP measurements on a pediatric or neonatal patient while the unit is in adult mode can result in inaccurate measurements and injury to the patient. Taking NIBP measurements on an adult patient while in pediatric or neonatal mode can result in inaccurate measurements.

---

## Taking a Single Measurement

You can take a single measurement by pressing the NIBP button () unless the R Series defibrillator is charged or charging.

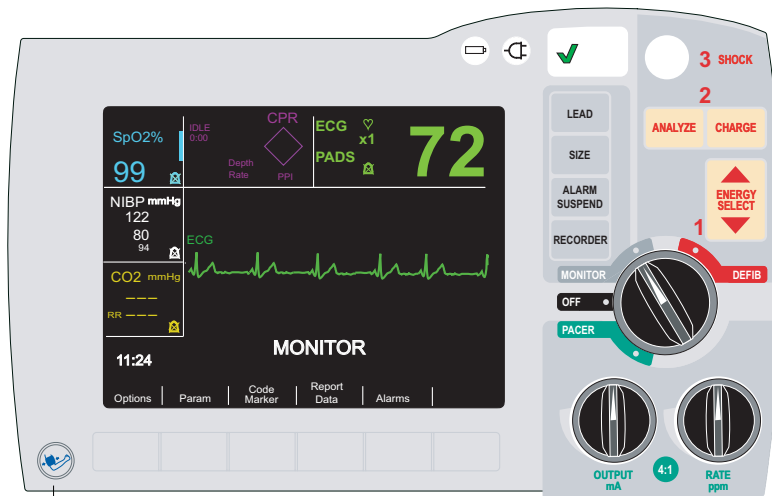
**Caution** Make sure that no measurement is being taken when you start a new measurement. If you press the NIBP button while the R Series unit is taking a measurement, the measurement aborts immediately and the cuff deflates.

---

**Caution** Before taking the first measurement, a period of at least 5 minutes should elapse to give time for blood pressure stabilization.

---

To take a single measurement, press the NIBP button on the R Series front panel.



NIBP Button

The R Series unit takes one blood pressure measurement.

## Taking STAT Measurements

You can set the R Series unit to take a STAT measurement, which consists of the unit taking as many blood pressure measurements as possible (up to 10) in five minutes. When the R Series unit finishes taking a measurement and the cuff deflates, it immediately starts another measurement.

Whenever practical, allow several minutes between STAT measurement sequences to restore full circulation to the monitored limb. Before initiating STAT measurements, allow the cuff pressure to deflate below 15 mmHg which will reset the adult mode safety pressure timer. In order to meet adult safety regulations, the safety timer will time out if the pressure does not drop down below 15 mmHg within 180 seconds regardless of how many measurements are performed within that time period.

---


**WARNING!** Repeated use of STAT measurements on the same patient over a short time interval can affect blood pressure readings, limit circulation to the limb, and cause injury to the patient.

---

You cannot set the R Series unit to take STAT measurements while the defibrillator is charged or charging. Charging the defibrillator aborts all STAT measurements and deflates the cuff.

### Starting STAT Measurements

To start STAT measurements, either:

- Press the **NIBP** button (  ) and hold for two seconds (if the unit is configured to do so), or
- Press the **NIBP Stat** softkey.

If the **NIBP Stat** softkey label is not displayed, see “Displaying the NIBP Menu” on page 12.

If the R Series unit is configured to automatically generate strips, it prints a history of the STAT measurements at the end of the 5-minute period.

**Caution** Before taking the first measurement, a period of at least 5 minutes should elapse to give time for blood pressure stabilization.

### Aborting STAT Measurements

You can abort STAT measurements at any time. Doing so terminates the current measurement and all subsequent measurements.

To abort STAT measurements, either:

- Press the **NIBP** button (  ), or
- Press the **NIBP Stat** softkey.

If the **NIBP Stat** softkey label is not displayed, see “Displaying the NIBP Menu” on page 12.

The R Series unit immediately aborts all measurements, and the cuff deflates.

## Taking Automatic Measurements

You can set the R Series unit to automatically take a series of measurements at selected intervals. For example, if you set the R Series unit to take an automatic measurement with an interval of 15 minutes, it immediately takes a measurement, waits 15 minutes, takes another measurement, waits another 15 minutes, and so on.

To take automatic measurements at set intervals, you must:

1. Set the measurement interval (if not set to desired value).
2. Start automatic measurements.

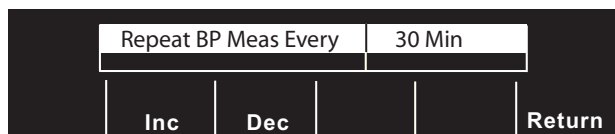
### Setting the Measurement Interval

Before you take automatic measurements, ensure that the measurement interval is properly set. The measurement interval is the time period between when one measurement starts and the next measurement starts. The measurement interval options (in minutes) are: 2.5, 3, 4, 5, 6, 7, 8, 9, 10, 15, 20, 30, 45, 60, 90, and 120.

When you turn on the R Series unit, the measurement interval is set to the default value of 30 minutes. To change the default, see the *R Series Configuration Guide*.

To set measurements intervals:

1. Press the the **Settings** softkey, then the **Auto Interval** softkey from the NIBP menu.  
If the **Settings** softkey is not displayed, see “Displaying the NIBP Menu” on page 12.  
The R Series unit displays the Auto Interval menu:




2. Press the **Inc** or the **Dec** softkey to scroll through the interval options.

3. Press the **Return** softkey to select the desired measurement interval and return to NIBP menu.

The measurement interval sets and remains until 10 seconds after the R Series unit is turned off, or the value is reset.

### Starting Automatic Measurements

To start automatic measurements, either:

- Press the **NIBP** button (  ) and hold for 2 seconds (if the unit is configured to do so), or
- Press the **NIBP Auto** softkey. If the **NIBP Auto** softkey label is not displayed, see “Displaying the NIBP Menu” on page 12.)

The R Series unit takes a measurement, and repeats subsequent measurements at the selected interval.

Note that if the defibrillator is charged or charging when the R Series unit is about to take an automatic measurement, it aborts the blood pressure measurement. All subsequent automatic measurements take place at their scheduled time.

**Note:** If it is necessary to replace the battery of the R Series unit and AC power is not connected during an automatic NIBP interval, the interval will be extended by the time it takes to replace the battery up to 10 seconds.

---

**Caution** Before taking the first measurement, a period of at least 5 minutes should elapse to give time for blood pressure stabilization.

---

### Taking an Additional Measurement

You can take an immediate measurement between the automatic measurements except when:

- The R Series unit is currently taking a measurement.
- The defibrillator is charged or charging.

To take an additional measurement, press the **NIBP** button (  ).

The R Series unit takes an extra measurement without altering the timing of the other measurements. It does not start a new automatic measurement unless 30 seconds have elapsed since the end of the previous completed measurement cycle. If the extra measurement completes less than 30 seconds before a scheduled measurement, the R Series unit omits the scheduled measurement.

### Aborting a Single Measurement

When the R Series unit is taking automatic measurements, you can stop a single blood pressure measurement by pressing the **NIBP** button.

The R Series unit immediately stops taking the measurement and deflates the cuff, but takes all subsequent automatic measurements at their selected interval.

### Stopping All Automatic Measurements


You can stop all upcoming blood pressure measurements. If the R Series unit is taking a measurement, it completes the current measurement, but does not take any subsequent measurements.

To stop automatic measurements, simply press the **NIBP Auto** softkey. (If the NIBP Auto softkey label is not displayed, see “Displaying the NIBP Menu” on page 12.)

## Aborting Measurements

You can immediately abort a blood pressure measurement at any time whether you are in MONITOR, DEFIB or PACER mode (ON for BLS/Plus models, in Manual mode only).

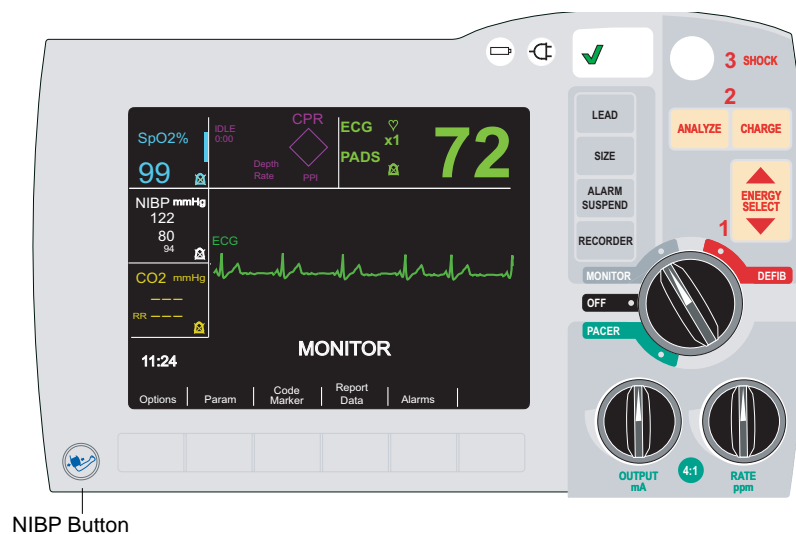
To abort the current measurement:

- Press the **NIBP** button (  ) on the R Series front panel.  
The R Series unit immediately stops taking the measurement, displays the *NIBP MEAS ABORTED* message, and deflates the cuff.

---

**WARNING!** Make sure that a measurement has already started before attempting to abort. If you press the NIBP button while a measurement is not being taken, the R Series unit starts a new measurement.

---



Note that:

- If you press the NIBP button while taking a STAT measurement, the R Series unit terminates all subsequent measurements.
- If you press the NIBP button while the R Series unit is taking an automatic measurement, it aborts the current measurement, deflates the cuff, and takes all subsequent measurements at the set interval.



## Viewing Trend Data

To view the patient's trend data over the past 4 hours, press the **Trend** softkey. The time, HR/PR, and readings will be displayed.

TIME	HR/PR	SpO2 %	NIBP mmHg		
			SYS	DIA	M
11:22	92	99	127	81	96
11:27	91	99	127	81	96
11:32	91	98	126	72	99
11:37	92	99	126	73	100
11:42	72	98	86	65	72 *
11:47	86	99	88	54	65
11:52	87	97	81	53	62
11:57	91	98	125	72	99
12:02	92	99	127	81	96

Print Older Newer Return

Measurements with alarm values are highlighted; an asterisk (\*) shows measurements that contain artifact.

Press **Older** to view previous entries if available; press **Newer** to return to newer entries. The screen updates automatically during automatic or STAT measurements.

Press the **Print** softkey to print the displayed measurements.

Press the **Return** softkey to return to the main menu.

The patient's trend data is cleared when the R Series unit remains off for more than 10 seconds.

## Printing Data

A strip recorder is provided with the R Series unit to document events and data. See the "Recorder Operation" section of the *R Series Operator's Guide* for instructions on how to record data. If you have already taken NIBP measurements, press the RECORDER button to print a stripchart that includes the following values for the currently displayed measurement:

- Systolic blood pressure
- Diastolic blood pressure
- Mean blood pressure
- Pulse rate
- Time of measurement

## Checkout Procedure

Perform the following checkout procedure daily to ensure that the NIBP option is functioning properly. This daily checkout procedure also ensures that medical personnel maintain familiarity with the proper use of the NIBP option.

For more specific instructions on how to accomplish each step listed below, refer to the related section in this manual.

Perform the daily checkout procedure as follows:

1. Select the proper size cuff, as described in “Selecting the Proper Size Cuff” on page 8.
2. Connect the hose to the R Series unit and to the cuff, as described in “Connecting the Hose” on page 9.
3. Apply the cuff to a human test subject, as described in “Applying the Cuff to the Patient” on page 10.
4. Set the cuff inflation pressure (if current setting is not appropriate), as described in “Setting Cuff Inflation Pressure” on page 14.
5. Take a blood pressure measurement.  
During cuff inflation, inspect cuff, hoses, and connectors for air leakage. If a leak is present, correct, replace, or service item.
6. Verify that the unit displays no error messages.
7. Verify that the displayed blood pressure values are correct.
8. With alarms enabled, verify that the patient alarms are functional by adjusting the high and low limits and repeating the above blood pressure measurement. Check that the unit:
  - emits a continuous audio tone, and
  - highlights the alarming parameter’s value and flashes the alarm symbol on the display.
9. Visually inspect hose, hose connector, and cuffs for signs of damage. If damaged, replace the damaged item.

## Cleaning the Hose and Reusable Cuffs

You can clean the hose and reusable cuffs by wiping the surface with a damp cloth and disinfecting with a mild disinfectant solution. Blow dry air through the hose before use; likewise, ensure the reusable cuff is dry before use.

## NIBP Accessories

The following accessories can be used with the R Series NIBP option:

<b>NIBP CUFFS</b>		
<b>Cuffs</b>	<b>Limb Circumference</b>	<b>REF</b>
Thigh (Reusable)	38 to 50 cm (14.96 to 19.69 in.)	8000-1654
Large Adult (Reusable)	31 to 40 cm (12.20 to 15.75 in.)	8000-1653
Adult (Reusable)	23 to 33 cm (9.06 to 12.99 in.)	8000-1651
Small Adult (Reusable)	17 to 25 cm (6.69 to 9.84 in.)	8000-1650
Child (Reusable)	12 to 19 cm (4.72 to 7.48 in.)	8000-1655
Neonate #5 (Disposable)	8.0 cm to 15.0 cm (3.1 to 5.9 in.)	8000-0644

<b>NIBP CUFFS</b>		
<b>Cuffs</b>	<b>Limb Circumference</b>	<b>REF</b>
Neonate #4 (Disposable)	7.0 to 13.0 cm (2.8 to 5.1 in.)	8000-0643
Neonate #3 (Disposable)	6.0 to 11.0 cm (2.4 to 4.3 in.)	8000-0642
Neonate #2 (Disposable)	4.0 to 8.0 cm (1.6 to 3.1 in.)	8000-0641
Neonate #1 (Disposable)	3.0 to 6.0 cm (1.2 to 2.4 in.)	8000-0640

<b>NIBP HOSES</b>		
<b>Hoses</b>	<b>Length (m)</b>	<b>REF</b>
Air hose with pneumatic fittings	3 m (9.8 ft.)	8000-0662
Air hose with pneumatic fittings	1.5 m (4.9 ft.)	8000-0655

## Troubleshooting

The following table lists the error messages and problems associated with the NIBP option and the associated corrective action(s). Read this section carefully. For further assistance, call ZOLL Technical Service at 1-800-348-9011. International customers should call the nearest authorized ZOLL Medical Corporation representative.

Message/Symptom	Problem	User Action
--- (dashed lines in NIBP field)	No NIBP measurement has been taken. The last measurement taken has expired after 120 minutes. The patient type has been changed.	None, normal operation.  Repeat NIBP measurement.
CALIBRATE NIBP	NIBP calibration is incomplete or failed	Recalibrate NIBP. (See the <i>R Series Service Manual</i> for details).
NIBP COMM ERROR	There is a communication problem with the NIBP module.	Cycle power and retry. If problem persists, return for service.
NIBP FAULT	No communication from the NIBP module. NIBP module failed self-test.	Cycle power, and retry. If the problem persists, return for service.
NIBP MEAS ABORTED	Cuff inflation pressure is set too high for attached cuff. Inflation is too fast. R Series is unable to find systolic value for 180 seconds. Defibrillator is charged or charging. User initiated abort.	Verify that you are using proper size cuff. Check for cuff and hose blockages. Confirm that the unit was not charging. If the problem persists, return for service.
NIBP NOT READY	The defibrillator is charged or charging in progress. NIBP module is performing power-up self-test.	Wait until the unit discharges before taking the next measurement. Wait for more than 10 seconds after power-up before taking blood pressure measurements.
NIBP OUT OF RANGE	The data from the NIBP module is out of range.	Measure patient's blood pressure with other equipment. Check cuff fit and positioning. Switch cuff to other arm. If problem persists, return for service.
REPEAT NIBP MEAS	The unit exceeded the maximum number of inflation attempts. The unit exceeded the 180-second measurement time limit.	Check cuff and hose. Repeat NIBP measurement.

Message/Symptom	Problem	User Action
REPEAT NIBP MEAS alternating with <i>CHECK CUFF/HOSE</i>	Blood pressure cuff or hose is not installed correctly. Cuff or hose is faulty. Hose kinked or disconnected. Inflation rate too fast or too slow.	Check cuff connection to hose. Check hose connection to unit. Check for kinked hose or air leaks in the hose. If problem persists, replace cuff then hose.
REPEAT NIBP MEAS alternating with <i>NIBP ARTIFACT</i>	The unit is unable to detect systolic, diastolic or mean blood pressure due to excessive motion or vibration.	Take a single blood pressure measurement. Keep patient as still as possible. Insulate patient, cuff and hose from vibrations as much as possible.
<i>REPEAT NIBP MEAS</i> alternating with <i>NIBP SIGNAL WEAK</i>	There is a weak or no oscillometric signal.	Check cuff fit and positioning. Check hose connection to unit. Check for kinked hose. Increase cuff inflation pressure if clinically appropriate.
SYSTEM FAULT	Communication problem with the NIBP module.	Cycle power, and retry. If problem persists, return for service.
NIBP box displays a large "X"	Communication problem with the NIBP module.	Cycle power, and retry. If problem persists, return for service.
NIBP M.T. OFF	The NIBP motion tolerance feature is not functioning properly.	If problem persists, return for service.
False high reading	Cuff too small. Cuff not centered over brachial artery. Cuff too loose. Patient's limb below level of heart.	Select larger cuff. Readjust cuff. Reapply cuff or select smaller cuff. Raise patient's limb to heart level.
False low reading	Cuff too large. Limb above level of heart.	Select smaller cuff. Lower patient's limb to heart level.

## Specifications

Principle of Operation	Oscillometric																														
Warm-up Time	Operational in less than 10 seconds																														
Regulatory Standards	ANSI/AAMI SP10-2002; EN 1060-1: 1996 Specification for Non-invasive sphygmomanometers; EN 1060-3: 1997; EN 60601-2-30: 2000																														
NIBP Measurement Range	<table> <tr> <td>Systolic</td> <td>Adult: 40 – 260 mmHg; 5.3 – 34.6 kPa Pediatric: 40 – 160 mmHg; 5.3 – 21.3 kPa Neonatal: 40 – 130 mmHg; 5.3 – 17.3 kPa</td> </tr> <tr> <td>Diastolic</td> <td>Adult: 20 – 200 mmHg; 2.7 – 26.7 kPa Pediatric: 20 – 120 mmHg; 2.7 – 16.0 kPa Neonatal: 20 – 100 mmHg; 2.7 – 13.3 kPa</td> </tr> <tr> <td>Mean</td> <td>Adult: 30 – 220 mmHg; 4.0 – 29.3 kPa Pediatric: 30 – 133 mmHg; 4.0 – 17.7 kPa Neonatal: 30 – 110 mmHg; 4.0 – 14.6 kPa</td> </tr> </table>	Systolic	Adult: 40 – 260 mmHg; 5.3 – 34.6 kPa Pediatric: 40 – 160 mmHg; 5.3 – 21.3 kPa Neonatal: 40 – 130 mmHg; 5.3 – 17.3 kPa	Diastolic	Adult: 20 – 200 mmHg; 2.7 – 26.7 kPa Pediatric: 20 – 120 mmHg; 2.7 – 16.0 kPa Neonatal: 20 – 100 mmHg; 2.7 – 13.3 kPa	Mean	Adult: 30 – 220 mmHg; 4.0 – 29.3 kPa Pediatric: 30 – 133 mmHg; 4.0 – 17.7 kPa Neonatal: 30 – 110 mmHg; 4.0 – 14.6 kPa																								
Systolic	Adult: 40 – 260 mmHg; 5.3 – 34.6 kPa Pediatric: 40 – 160 mmHg; 5.3 – 21.3 kPa Neonatal: 40 – 130 mmHg; 5.3 – 17.3 kPa																														
Diastolic	Adult: 20 – 200 mmHg; 2.7 – 26.7 kPa Pediatric: 20 – 120 mmHg; 2.7 – 16.0 kPa Neonatal: 20 – 100 mmHg; 2.7 – 13.3 kPa																														
Mean	Adult: 30 – 220 mmHg; 4.0 – 29.3 kPa Pediatric: 30 – 133 mmHg; 4.0 – 17.7 kPa Neonatal: 30 – 110 mmHg; 4.0 – 14.6 kPa																														
NIBP Measurement Accuracy	Per AAMI SP10 +/- 5 mmHg (0.7 kPa) mean difference; 8 mmHg (1.1 kPa) standard deviation <sup>a</sup>																														
NIBP Measurement Resolution	1 mmHg; 0.13 kPa																														
NIBP Measurement Cycle Time	Typical: 30 seconds Worst Case: 180 seconds																														
Pulse Rate Range	30 – 220 pulses per minute																														
Pulse Rate Accuracy	±2% or ±3 bpm, whichever is greater																														
Pulse Rate Resolution	1 bpm (beats per minute)																														
Alarm Limits	<table> <tr> <td rowspan="3">Systolic</td> <td>Adult</td> <td>High 80 – 260 mmHg; Low 40 – 140 mmHg;</td> <td>High 10.7 – 34.7 kPa Low 5.3 – 18.7 kPa</td> </tr> <tr> <td>Pediatric</td> <td>High 80 – 160 mmHg; Low 35 – 140 mmHg;</td> <td>High 10.7 – 21.3 kPa Low 4.7 – 18.7 kPa</td> </tr> <tr> <td>Neonatal</td> <td>High 60 – 130 mmHg; Low 25 – 120 mmHg;</td> <td>High 8.0 – 17.3 kPa Low 3.3 – 16.0 kPa</td> </tr> <tr> <td rowspan="3">Diastolic</td> <td>Adult</td> <td>High 50 – 200 mmHg; Low 25 – 100 mmHg;</td> <td>High 6.7 – 26.7 kPa Low 3.3 – 13.3 kPa</td> </tr> <tr> <td>Pediatric</td> <td>High 50 – 130 mmHg; Low 20 – 100 mmHg;</td> <td>High 6.7 – 17.3 kPa Low 2.7 – 13.3 kPa</td> </tr> <tr> <td>Neonatal</td> <td>High 30 – 105 mmHg; Low 20 – 100 mmHg;</td> <td>High 4.0 – 14.0 kPa Low 2.7 – 13.3 kPa</td> </tr> <tr> <td rowspan="3">Mean</td> <td>Adult</td> <td>High 60 – 220 mmHg; Low 30 – 120 mmHg;</td> <td>High 8.0 – 29.3 kPa Low 4.0 – 16.0 kPa</td> </tr> <tr> <td>Pediatric</td> <td>High 60 – 140 mmHg; Low 30 – 120 mmHg;</td> <td>High 8.0 – 18.7 kPa Low 4.0 – 16.0 kPa</td> </tr> <tr> <td>Neonatal</td> <td>High 35 – 110 mmHg; Low 30 – 105 mmHg;</td> <td>High 4.7 – 14.7 kPa Low 4.0 – 14.0 kPa</td> </tr> </table>	Systolic	Adult	High 80 – 260 mmHg; Low 40 – 140 mmHg;	High 10.7 – 34.7 kPa Low 5.3 – 18.7 kPa	Pediatric	High 80 – 160 mmHg; Low 35 – 140 mmHg;	High 10.7 – 21.3 kPa Low 4.7 – 18.7 kPa	Neonatal	High 60 – 130 mmHg; Low 25 – 120 mmHg;	High 8.0 – 17.3 kPa Low 3.3 – 16.0 kPa	Diastolic	Adult	High 50 – 200 mmHg; Low 25 – 100 mmHg;	High 6.7 – 26.7 kPa Low 3.3 – 13.3 kPa	Pediatric	High 50 – 130 mmHg; Low 20 – 100 mmHg;	High 6.7 – 17.3 kPa Low 2.7 – 13.3 kPa	Neonatal	High 30 – 105 mmHg; Low 20 – 100 mmHg;	High 4.0 – 14.0 kPa Low 2.7 – 13.3 kPa	Mean	Adult	High 60 – 220 mmHg; Low 30 – 120 mmHg;	High 8.0 – 29.3 kPa Low 4.0 – 16.0 kPa	Pediatric	High 60 – 140 mmHg; Low 30 – 120 mmHg;	High 8.0 – 18.7 kPa Low 4.0 – 16.0 kPa	Neonatal	High 35 – 110 mmHg; Low 30 – 105 mmHg;	High 4.7 – 14.7 kPa Low 4.0 – 14.0 kPa
Systolic	Adult		High 80 – 260 mmHg; Low 40 – 140 mmHg;	High 10.7 – 34.7 kPa Low 5.3 – 18.7 kPa																											
	Pediatric		High 80 – 160 mmHg; Low 35 – 140 mmHg;	High 10.7 – 21.3 kPa Low 4.7 – 18.7 kPa																											
	Neonatal	High 60 – 130 mmHg; Low 25 – 120 mmHg;	High 8.0 – 17.3 kPa Low 3.3 – 16.0 kPa																												
Diastolic	Adult	High 50 – 200 mmHg; Low 25 – 100 mmHg;	High 6.7 – 26.7 kPa Low 3.3 – 13.3 kPa																												
	Pediatric	High 50 – 130 mmHg; Low 20 – 100 mmHg;	High 6.7 – 17.3 kPa Low 2.7 – 13.3 kPa																												
	Neonatal	High 30 – 105 mmHg; Low 20 – 100 mmHg;	High 4.0 – 14.0 kPa Low 2.7 – 13.3 kPa																												
Mean	Adult	High 60 – 220 mmHg; Low 30 – 120 mmHg;	High 8.0 – 29.3 kPa Low 4.0 – 16.0 kPa																												
	Pediatric	High 60 – 140 mmHg; Low 30 – 120 mmHg;	High 8.0 – 18.7 kPa Low 4.0 – 16.0 kPa																												
	Neonatal	High 35 – 110 mmHg; Low 30 – 105 mmHg;	High 4.7 – 14.7 kPa Low 4.0 – 14.0 kPa																												

Operating Time (with SpO <sub>2</sub> , EtCO <sub>2</sub> and NIBP options)	For a new, fully charged lithium ion battery pack at 20°C (68°F): <ul style="list-style-type: none"> <li>• 90 defibrillator discharges at maximum energy (200 J), or</li> <li>• 2.75 hours minimum of continuous ECG monitoring and blood pressure measurements once every 5 minutes, or 2.25 hours of continuous ECG monitoring/pacing at 60 mA, 70 beats per minute.</li> </ul>
Environmental	Operating Temperature: 0° to 40° C (32° to 104° F) Storage Temperature: -20° to 60° C (-4° to 140° F) Humidity: 5 to 95% relative humidity, non-condensing
Electromagnetic Immunity	AAMI DF-80; EN 61000-4-3: 2002, 10 V/m
Operating Pressure	594 to 1060 mBar

<sup>a</sup> Blood pressure measurements determined with this device are equivalent to those obtained by a trained observer using the cuff/stethoscope auscultation method, within the limits prescribed by the American National Standard, Electronic or Automated Sphygmomanometers (AAMI SP10). To receive a copy of the report containing the AAMI SP10 test results, contact ZOLL Technical Support at (800) 348-9011 or (978) 421-9655.







R Series®  
End Tidal Carbon Dioxide  
(EtCO<sub>2</sub>)

---

The issue date for the R Series End Tidal Carbon Dioxide (EtCO<sub>2</sub>) guide (**REF** 9650-0915-01 Rev. D) is December, 2017.

ZOLL and R Series are trademarks or registered trademarks of ZOLL Medical Corporation.

Copyright © 2017 by ZOLL Medical Corporation. All rights reserved.

CAPNOSTAT is a registered trademark, and CAPNO<sub>2</sub>mask and LoFlo are trademarks of Respirationics Novamatrix LLC.

Cidex is a registered trademark of Advanced Sterilization Products, a Johnson & Johnson Company.

Nafion is a registered trademark of DuPont.

System 1 is a registered trademark of the Steris Corporation.

All other trademarks and registered trademarks are property of their respective owners.

## Indication of use

The R Series system is indicated for the continuous noninvasive monitoring of end tidal carbon dioxide (EtCO<sub>2</sub>) and respiration rate in patients requiring ventilator support, in-hospital transport, or anesthesia. EtCO<sub>2</sub> Monitoring is indicated for in patients from newborn (neonate) to adult.

## Contraindications for Use

There are no known contraindications for the use of the EtCO<sub>2</sub> monitor.

## General Information

Federal (U.S.A.) law restricts this defibrillator to sale by or on the order of a physician.

---

---

# End-Tidal Carbon Dioxide (EtCO<sub>2</sub>)

---

## Product Description

R Series<sup>®</sup> units equipped with software revision 12.xx or higher support two End Tidal Carbon Dioxide (EtCO<sub>2</sub>) monitoring options for the continuous measurement of respiratory carbon dioxide (CO<sub>2</sub>) and respiration rate. These options use the same connector on the R Series unit and may be used interchangeably.

For R Series BLS/Plus models, these EtCO<sub>2</sub> options can only be used while the unit is in Manual mode.

The first option uses a unique, mainstream, solid-state, infrared sensor called the CAPNOSTAT<sup>®</sup> 5 Mainstream CO<sub>2</sub> Sensor. The CAPNOSTAT 5 CO<sub>2</sub> sensor is attached to an airway adapter that connects to an endotracheal (ET) tube or other airway and measures gases flowing through these breathing circuit components. A disposable mouthpiece may be connected to the adapter for monitoring non-intubated patients. A CAPNO<sub>2</sub>mask<sup>™</sup> is also available for use with non-intubated patients. This option provides for O<sub>2</sub> delivery while monitoring expired CO<sub>2</sub>.

The second option is a sidestream sampling system called the LoFlo<sup>™</sup> CO<sub>2</sub> Module. The LoFlo module contains a gas sampling pump, which draws small samples of gas from the patient's airway via a nasal/oral cannula or airway adapter, and passes these gases through a solid state infrared sensor (located away from the patient's airway) that measures CO<sub>2</sub>. While the sidestream system is typically used on non-intubated patients, it can also be used for EtCO<sub>2</sub> measurement on intubated infant, pediatric and adult patients. The sidestream system should not be used, however, on patients who cannot tolerate the 50ml/min removal of the sample gases from their breathing circuit. The sidestream module uses specially designed cannulas and airway adapters for sampling airway gases and passing them through an integrated sample cell, which connects to the LoFlo module's CO<sub>2</sub> sensor. These cannulas incorporate a filter and sample cell, providing maximum filtration of fluids and contaminants, and protecting the system from aspiration of these fluids.

In both systems, the CO<sub>2</sub> sensor generates infrared light and beams it through the airway adapter or sample cell to a detector on the opposite side. CO<sub>2</sub> from the patient, flowing through the mainstream airway adapter or sample cell, absorbs some of this infrared energy. The R Series unit determines CO<sub>2</sub> concentration in the breathing gases by measuring the amount of light absorbed by gases flowing through the airway or sample cell.

The R Series unit displays EtCO<sub>2</sub> (the concentration of carbon dioxide detected at the end of each exhalation) as a numerical value in millimeters of mercury (mmHg), percent (%), or kilopascals (kPa). In addition, the unit can display a capnogram. This capnogram is a valuable clinical tool that can be used to assess patient airway integrity and proper endotracheal (ET) tube placement. The unit calculates respiration rate by measuring the time interval between detected peaks of the CO<sub>2</sub> waveform. The technology differentiates between waveforms caused by breathing and those caused by cardiogenic oscillations and artifact.

## How to Use This Manual

This section explains how to set up and use the R Series End Tidal Carbon Dioxide option. Important safety information relating to general use of the R Series End Tidal Carbon Dioxide monitor appears in the “Safety Considerations” section of this manual.

The *R Series Operator’s Guide* provides information operators need for the safe and effective use and care of the R Series unit. It is important that persons using this device read and understand all the information contained therein.

Please read both safety considerations and warnings sections thoroughly before operating your R Series unit.

All CAPNOSTAT 5 sensor, LoFlo module, airway adapter and cannula questions with regards to the Declaration of Conformity with European Union Directives should be directed to the authorized ZOLL representative:

ZOLL International Holding B.V.  
Newtonweg 18  
6662 PV ELST  
The Netherlands  
+31 (0) 481 366410 Telephone  
+31 (0) 481 366411 Telefax

## Safety Considerations

### Warnings



#### General

Carefully read the *R Series Operator’s Guide* and these operating instructions before operating the EtCO<sub>2</sub> monitoring option.

Ensure that the R Series EtCO<sub>2</sub> option is operated by qualified personnel only.

Do not use the R Series EtCO<sub>2</sub> option as an apnea monitor.

Do not immerse the R Series unit, patient cables, or sensors in water, solvents, or cleaning solutions.

If the accuracy of any reading is suspect, first check the patient’s vital signs by alternate means and then check the R Series EtCO<sub>2</sub> option for proper operation.

If an alarm condition occurs while the alarms are suspended, the suspended alarm indications will only be visual displays and symbols. No audio alarm indications will occur.

Elevated oxygen levels, nitrous oxide, or halogenated agents contained in the breathing gases may degrade the accuracy of measurements made with the R Series EtCO<sub>2</sub> option. Activate oxygen compensation if O<sub>2</sub> levels in excess of 60% are introduced. Activate N<sub>2</sub>O compensation if nitrous oxide is introduced into the airway circuit.

Do not use the LoFlo module on patients who cannot tolerate the removal of 50ml/min of breathing gases from the airway.

The presence of Desflurane beyond 5% may positively bias the carbon dioxide reading by up to 3 mmHg. The presence of Xenon in the exhaled breath may negatively bias the reading by up to 5 mmHg.

Carefully route patient cabling to reduce the possibility of patient entanglement or strangulation.

Do not touch the bed, patient, or any equipment connected to the patient during defibrillation. A severe shock can result. Do not allow exposed portions of the patient's body to come in contact with metal objects, such as a bed frame, as unwanted pathways for defibrillation current may result.

### **CAPNOSTAT 5 and Accessories**

Always ensure the integrity of the patient breathing circuit after insertion of the airway adapter by verifying a proper CO<sub>2</sub> waveform (capnogram) on the monitor display.

Do not use CAPNOSTAT 5 or LoFlo sensors in the presence of flammable anesthetics or other flammable gases.

Do not attempt to open the sensor. An electrical shock hazard exists internally. Refer servicing to qualified personnel.

Do not operate the sensor when it is wet or has exterior condensation.

## **Cautions**

**CAUTION:** Federal (U.S.A.) law restricts this device to sale, or use by or on the order of a licensed medical practitioner.

Use only ZOLL/Respironics Novamatrix CAPNOSTAT 5 sensors and LoFlo modules, airway adapters, nasal and nasal/oral cannula sets with the R Series EtCO<sub>2</sub> option.

The device is protected against interference from radio frequency emissions typical of two-way radios and cellular phones (digital and analog) used in emergency service/public safety activities. Users should assess the device's performance in their typical environment of use for the possibility of radio frequency interference from high-power sources. Radio Frequency Interference (RFI) may be observed as shifts in monitor baseline, trace compression, display brightness changes or transient spikes on the display.

Do NOT sterilize or immerse the CAPNOSTAT 5 CO<sub>2</sub> sensor or LoFlo module.

Do NOT reuse, disassemble, sterilize, disinfect, or clean the disposable airway adapter, airway adapter with mouthpiece, CAPNO<sub>2</sub>mask, nasal or or nasal/oral sampling cannula sets, as system performance will be compromised. These items are intended for single patient use only.

Do NOT use a damaged sensor or airway adapter.

Do NOT use the device if it fails to operate properly.

Do NOT place the mainstream or sidestream airway adapters between the ET tube and the breathing circuit elbow, as this may cause patient secretions to accumulate in the adapter.

Position airway adapters with windows in a vertical, NOT a horizontal, position. This helps keep patient secretions from pooling on the windows.

Do NOT insert any object other than the sample cell into the sample cell receptacle on the LoFlo module.

Remove the LoFlo sample cell from the sample cell receptacle when not in use.

Clean or replace the airway adapter if excessive secretions are observed.

ZOLL Medical Corporation recommends that the airway adapter be removed from the circuit whenever aerosolized medication is delivered. The increased viscosity of the medications may contaminate the adapter windows, requiring premature cleaning or replacement of the adapter.

In order to eliminate the potential build up of CO<sub>2</sub> inside the storage bag, ensure that the LoFlo module exhaust tube vents gases away from the module environment.

To avoid injury to the patient, remove the nasal/oral cannula from the patient before cutting the oral cannula tip.

Do NOT apply tension to the sensor cable.

Periodically inspect the sampling tubing for the absence of kinks.

Monitor the capnogram for an elevated baseline. If an elevated baseline is observed, verify patient condition first. If the caregiver determines that the patient condition is not contributing to the elevated baseline, follow the instructions for zeroing the sensor or module detailed in this manual.

Do NOT store sensors, modules, airway adapters, or cannula sets at temperatures less than -40° C or greater than 70° C.

Do not operate CAPNOSTAT sensors at temperatures less than 0° C or greater than 45° C. Do not operate LoFlo modules at temperatures less than 0° C or greater than 40° C.

Do not use the LoFlo module on R Series units that have a software version lower than 12.xx.



## EtCO<sub>2</sub> Intended Use

The ZOLL R Series EtCO<sub>2</sub> option with Respironics Novamatrix technology is intended to be used for continuous noninvasive monitoring of end tidal carbon dioxide (EtCO<sub>2</sub>) and respiration rate in patients requiring ventilator support, in-hospital transport, or anesthesia. The R Series EtCO<sub>2</sub> option with Respironics Novamatrix technology supports two methods for continuous measurement of end tidal carbon dioxide (EtCO<sub>2</sub>) and respiration rate.

The first method uses the CAPNOSTAT 5 Mainstream CO<sub>2</sub> sensor attached to an airway adapter that connects to an endotracheal tube, mask or disposable mouthpiece.

The second method uses the LoFlo CO<sub>2</sub> module to monitor both non-intubated and intubated patients using specially designed sampling cannulas and airway adapters.

The R Series EtCO<sub>2</sub> option is designed to monitor adult, pediatric, and neonatal patients.

The following substances can influence CO<sub>2</sub> measurements made with the CAPNOSTAT 5 CO<sub>2</sub> sensor:

- elevated oxygen levels
- nitrous oxide
- halogenated agents

The R Series EtCO<sub>2</sub> option provides settings for high oxygen and/or nitrous oxide compensation. Halogenated anesthetic agents alter CO<sub>2</sub> readings, but the R Series unit will monitor CO<sub>2</sub> within specifications when these agents are present at normal clinical levels. The presence of Desflurane in the exhaled breath beyond normal values (5%) may positively bias measured carbon dioxide values by up to an additional 3 mmHg.

The R Series EtCO<sub>2</sub> option is intended for use only with the ZOLL/Respironics Novamatrix CAPNOSTAT 5 Mainstream CO<sub>2</sub> Sensor and mainstream airway adapters, the LoFlo CO<sub>2</sub> Module, nasal and nasal/oral sampling cannula sets, and sidestream on-airway adapters. The R Series EtCO<sub>2</sub> option can be used on adult patients (21 years of age and older) and on pediatric patients, as described in the following table:

Pediatric Subpopulation	Approximate Age Range
Newborn (neonate)	Birth to 1 month of age
Infant	1 month to 2 years of age
Child	2 to 12 years of age
Adolescent	12-21 years of age

## Mainstream EtCO<sub>2</sub> Setup

There are several steps involved with mainstream EtCO<sub>2</sub> setup. These steps include:

- Attaching the CAPNOSTAT sensor cable.
- Selecting a mainstream airway adapter.
- Attaching the airway adapter to the CAPNOSTAT sensor.
- Zeroing the CAPNOSTAT sensor/airway adapter.
- Attaching the airway adapter to the airway circuit.
- Applying an airway adapter with mouthpiece.

## Attaching the CAPNOSTAT 5 CO<sub>2</sub> Sensor Cable

To attach the CAPNOSTAT 5 CO<sub>2</sub> sensor cable, plug the cable's connector into the yellow CO<sub>2</sub> connector at the back of the R Series unit by matching the key on the cable to the key on the connector (Figure 1).

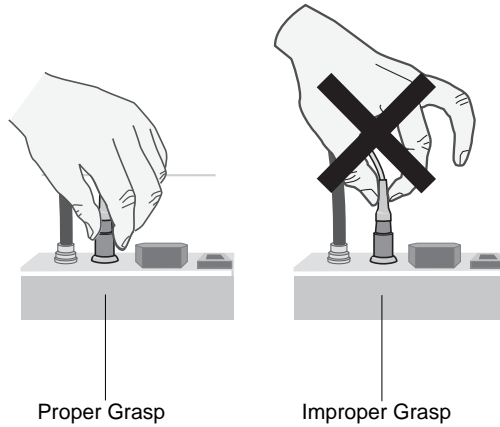


Figure 1

**Note:** To remove the sensor cable from the R Series unit, grasp the collar surrounding the cable's R Series connector and pull up.

## Selecting a Mainstream Airway Adapter

Select an airway adapter based on the patient's ET tube diameter and monitoring situation. For more information refer to the following table or contact ZOLL Medical Corporation.

Airway Adapter Type	ET Tube Diameter
SPU* Pediatric/Adult	> 4.0 mm
Adult Reusable	> 4.0 mm
SPU* Neonatal/Pediatric	≤ 4.0 mm
Neonatal Reusable	≤ 4.0 mm

\*SPU = Single Patient Use

## Attaching the Airway Adapter to the CAPNOSTAT 5 CO<sub>2</sub> Sensor

Before attaching the airway adapter to the CAPNOSTAT 5 CO<sub>2</sub> sensor, verify that the airway adapter windows are clean and dry. Clean or replace the adapter if necessary.

**Caution** The disposable (SPU) Pediatric/Adult and the Neonatal/Pediatric airway adapters are intended for single patient use. Do NOT reuse or sterilize these adapters as system performance will be compromised.

Attach the airway adapter to the CAPNOSTAT sensor, as follows:

1. Align the arrow on the bottom of the airway adapter with the arrow on the bottom of the sensor.

2. Press the sensor and airway adapter together until they click.
3. Turn the Selector switch on the R Series unit to **MONITOR** (**ON** for BLS/Plus units, and select **Manual** mode).
4. Wait for the airway adapter and sensor to warm up.  
The unit will display the *CO<sub>2</sub> WARM UP* message for approximately one minute while the sensor and adapter warm to operating temperature. The message disappears when the sensor is ready to use.  
**Note:** Warm up time varies with ambient temperature of the sensor.
5. If the unit displays the *CHECK CO<sub>2</sub> ADAPTER* message, follow steps a through c.
  - a. Verify proper connection of the adapter to the sensor.
  - b. Verify that the airway adapter windows are clean and dry.
  - c. If the adapter is properly connected, and the windows are clean and dry, then zero the adapter as described in the next section, “Zeroing the Mainstream CAPNOSTAT 5 CO<sub>2</sub> Sensor/Airway Adapter.”

## Zeroing the Mainstream CAPNOSTAT 5 CO<sub>2</sub> Sensor/Airway Adapter

**Note:** Do not zero the CAPNOSTAT without an airway adapter installed.

Adapter zeroing compensates for the optical differences between airway adapters and should be performed at certain times. Zeroing is recommended after switching between single patient use and reusable airway adapters, in order to obtain accurate readings. It is also recommended the first time a particular CAPNOSTAT 5 CO<sub>2</sub> sensor is connected to the unit.

1. Place the sensor with the adapter installed away from all sources of CO<sub>2</sub> (including the patient’s – and your own – exhaled breath and ventilator exhaust valves).
2. Press the **Param** softkey, then the **CO<sub>2</sub>** softkey.
3. Press the **Zero** softkey.

The unit zeroes the adapter and displays the *ZEROING CO<sub>2</sub> ADAPTER* message for 15 to 20 seconds.

The unit displays the message *ZERO DONE* upon completion of the zeroing.

**Note:** Do not attempt zeroing for 20 seconds after removing the adapter from the patient’s airway. This time allows any CO<sub>2</sub> remaining in the adapter to dissipate before zeroing. Do not attempt to zero the adapter while it is connected to the patient’s airway. Zeroing with CO<sub>2</sub> in the adapter can lead to inaccurate measurement and/or other error conditions. If you attempt zeroing while CO<sub>2</sub> remains in the adapter, the time required to zero the adapter may be increased. If zeroing cannot be completed, the message *ZERO FAILED* will be displayed. If this occurs, clear any occlusion in the adapter, remove any source of CO<sub>2</sub>, wait 20 seconds, and try zeroing again.

## Attaching the Airway Adapter to the Airway Circuit

If you have not yet done so, you must attach the airway adapter to the CAPNOSTAT 5 CO<sub>2</sub> sensor before attaching the breathing adapter to the airway circuit. Refer to “Attaching the Airway Adapter to the CAPNOSTAT 5 CO<sub>2</sub> Sensor” on page 6 if necessary.

Attach the airway adapter to the breathing circuit as follows:

1. Place the CAPNOSTAT 5 CO<sub>2</sub> sensor/airway adapter assembly between the elbow and the ventilator circuit wye, as shown in Figure 2.

**Note:** Do NOT place the airway adapter between the ET tube and the elbow, as this may allow patient secretions to accumulate in the adapter.

Position the airway adapter with its windows in a vertical, NOT a horizontal, position. This helps keep patient secretions from pooling on the windows. If pooling does occur, the airway adapter may be removed from the circuit, rinsed with water and reinserted into the circuit. To prevent moisture from draining into the airway adapter, do NOT place the airway adapter in a gravity dependent position.

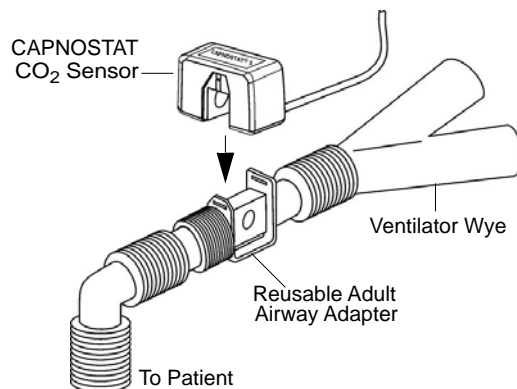


Figure 2

2. Check that connections have been made correctly by verifying the presence of a proper CO<sub>2</sub> waveform on the R Series display.
3. The sensor cable should face away from the patient.

## Applying an Airway Adapter with Mouthpiece

The disposable Pediatric/Adult airway adapter with mouthpiece can be used for spot checking CO<sub>2</sub> on non-intubated adult or pediatric patients.

---

**Caution** The disposable Pediatric/Adult Airway Adapter with mouthpiece is intended for single patient use. Do NOT reuse or sterilize the adapter, as system performance will be compromised.

---

1. Remove adapter with mouthpiece from the package. Verify that the adapter and mouthpiece are intact and securely fastened to each other.
2. Attach the airway adapter to the CAPNOSTAT 5 CO<sub>2</sub> sensor, as follows:
  - a. Align the arrow on the bottom of the airway adapter with the arrow on the bottom of the CAPNOSTAT sensor.

b. Press the sensor and airway adapter together until they click (see Figure 3).

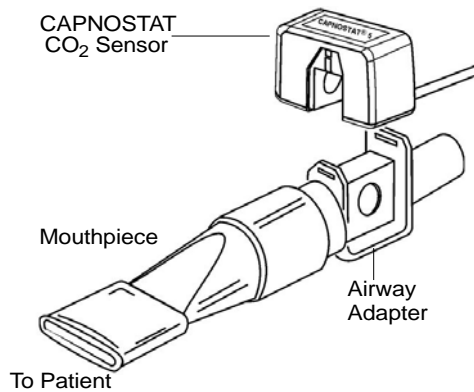


Figure 3

3. If the unit displays the *CHECK CO<sub>2</sub> ADAPTER* message, follow steps a through c, then go to step 4.
  - a. Verify proper connection of the adapter to the sensor.
  - b. Verify that the airway adapter windows are clean and dry.
  - c. If the adapter is properly connected, and the windows are clean and dry, then zero the adapter as described in “Zeroing the Mainstream CAPNOSTAT 5 CO<sub>2</sub> Sensor/Airway Adapter” on page 7.
4. Ensure the patient seals his or her mouth completely around the mouthpiece and breathes normally.

A nose clip may be needed if the patient is exhaling through the nose. It is important that all, or most, of the exhalation be routed through the airway adapter.

## Sidestream EtCO<sub>2</sub> Setup

There are several steps involved with sidestream EtCO<sub>2</sub> setup. These steps include:

- Attaching the LoFlo Module Cable
- Selecting a Sidestream Airway Adapter Kit or Cannula
- Inserting the Sample Cell
- Zeroing the LoFlo CO<sub>2</sub> Module/Sample Cell
- Applying a Sidestream Airway Adapter Kit
- Applying a Nasal or Nasal/Oral Cannula

### Attaching the LoFlo Module Cable

To attach the LoFlo module cable, plug the cable into the yellow CO<sub>2</sub> connector at the back of the R Series unit by matching the key on the cable to the key on the connector.

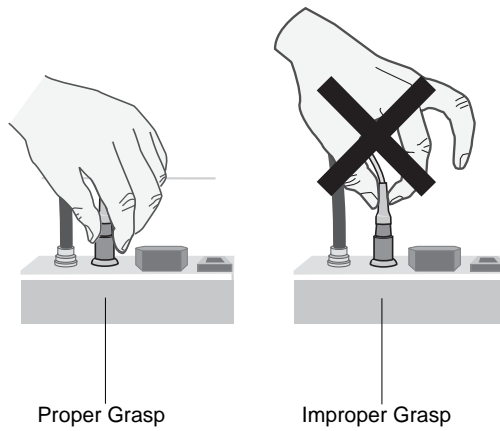


Figure 4

To remove the sensor cable from the R Series unit, grasp the collar surrounding the cable's R Series connector and pull up.

## Selecting a Sidestream Airway Adapter Kit

Select an airway adapter kit based on the patient's size, ET tube diameter, and monitoring situation. Airway adapter kits are disposable and single patient use.

Airway Adapter Kit	ET Tube Diameter
Adult/Pediatric Airway Adapter Kit	> 4.0 mm
Adult/Pediatric Airway Adapter Kit with Nafion® tubing	
Pediatric/Infant Airway Adapter Kit	≤ 4.0 mm
Pediatric/Infant Airway Adapter Kit with Nafion tubing	

**Note:** For monitoring times exceeding 6 hours, Nafion tubing is recommended.

## Selecting a Sidestream Cannula

Select a sidestream cannula based on the patient's size and monitoring situation. Nasal and nasal/oral cannulas are disposable and single patient use.

Cannula	Application
Nasal CO <sub>2</sub> Sampling Cannula, Adult	Nasal CO <sub>2</sub> sampling only
Nasal CO <sub>2</sub> Sampling Cannula, Pediatric	
Nasal CO <sub>2</sub> Sampling Cannula, Infant	
Oral/Nasal CO <sub>2</sub> Sampling Cannula, Adult	Oral/Nasal CO <sub>2</sub> sampling only
Oral/Nasal CO <sub>2</sub> Sampling Cannula, Pediatric	
Nasal CO <sub>2</sub> Sampling with O <sub>2</sub> Delivery Cannula, Adult	Nasal CO <sub>2</sub> sampling with oxygen delivery
Nasal CO <sub>2</sub> Sampling with O <sub>2</sub> Delivery Cannula, Pediatric	
Oral/Nasal CO <sub>2</sub> Sampling with O <sub>2</sub> Delivery Cannula, Adult	Oral/Nasal CO <sub>2</sub> sampling with oxygen delivery
Oral/Nasal CO <sub>2</sub> Sampling with O <sub>2</sub> Delivery Cannula, Pediatric	

## Inserting the Sample Cell

Follow these steps:

1. Remove the LoFlo sampling cannula or airway adapter kit from the package.
2. Insert the LoFlo sample cell into the LoFlo sample cell receptacle and ensure that it clicks into place.

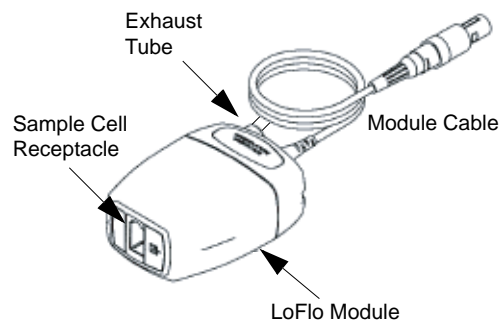


Figure 5

3. Ensure that the LoFlo module exhaust tube vents gases away from the module environment.
4. Turn the selector switch on the R Series to MONITOR (ON for BLS/Plus units).
5. Wait for the CO<sub>2</sub> module to warm up.

The unit will display the *WARM UP* message for approximately one minute while the module warms up to operating temperature. The message disappears when the module is ready for use.

**Note:** Warm up time varies with ambient temperature of the module.

## Zeroing the LoFlo CO<sub>2</sub> Module/Sample Cell

The module/sample cell zero allows the LoFlo CO<sub>2</sub> module to adjust to the optical characteristics of the sample cell. While zeroing is recommended the first time a particular

LoFlo module is connected to the unit, it is only absolutely necessary when the message *ZERO CO<sub>2</sub> MODULE* is displayed.

---

**Caution** Always ensure that the sample cell is properly connected to the LoFlo module before zeroing.

---

1. Ensure that the nasal cannula or on-airway adapter is not connected to the patient or close to any source of CO<sub>2</sub> (including the patient's—and your own—exhaled breath and ventilator exhaust valves).
2. Press the **Param.** softkey and then the **CO<sub>2</sub>** softkey, then press **Enter**.
3. Press the **Zero** softkey.

The unit zeroes the module and displays the *ZEROING CO<sub>2</sub> MODULE* message for approximately 15-20 seconds.

The unit displays the message *ZERO DONE* upon completion of the zeroing.

**Note:** Do not attempt zeroing for 20 seconds after removing the adapter or cannula from the patient's airway. This time allows any CO<sub>2</sub> remaining in the adapter or cannula to dissipate before zeroing. Do not attempt to zero the module while the adapter or cannula is in the patient's airway. Zeroing with CO<sub>2</sub> in the adapter or cannula can lead to inaccurate measurements and/or other error conditions. If you attempt zeroing while CO<sub>2</sub> remains in the adapter or cannula, the time required to zero the module may be increased. If zeroing cannot be completed, the message "ZERO FAILED" will be displayed. If this occurs, clear any occlusion in the adapter or cannula, remove the source of CO<sub>2</sub>, wait 20 seconds, and try zeroing again.

## Applying a Sidestream Airway Adapter Kit

The sidestream airway adapter kit is intended for monitoring the EtCO<sub>2</sub> of intubated patients.

Before attaching the airway adapter to the breathing circuit, verify that the adapter is clean, dry, and undamaged. Replace if necessary.

---

**Caution** The disposable (SPU) Adult/Pediatric and Pediatric/Infant airway adapter kits are intended for single patient use. Do NOT reuse or sterilize these adapters as system performance will be compromised.

---

1. Attach the airway adapter kit's sample cell to the sample cell receptacle on the LoFlo module, and ensure that it clicks into place.
2. If the unit displays either of the following messages take the appropriate action.



If you see this message:	Take this action:
CHECK CO <sub>2</sub> LINE	<p>Verify that the sample cell is plugged into the module and seated properly.</p> <p>Verify that neither the sample line nor the exhaust tube are blocked, kinked, or pinched. Verify that the airway adapter is not blocked. If the sample line, exhaust tube, or the airway adapter is blocked or otherwise compromised for 15 seconds, this message will appear. The pump will shut off after 2 minutes if the condition that caused the message is not cleared. To restart the pump, correct the blockage, then remove and reinsert the sample cell into the sample cell receptacle.</p> <p>If the problem persists, replace the sample line.</p>
CHECK CO <sub>2</sub> MODULE	<p>Check that module cable is plugged in and seated properly.</p> <p>Check that module is not exposed to excessive heat.</p> <p>If problem persists, replace module.</p>

- Place the airway adapter assembly at the proximal end of the airway circuit between the elbow and the ventilator circuit wye. Do NOT place the airway adapter between the ET tube and the elbow as this may allow patient secretions to accumulate in the adapter.  
If pooling does occur, the airway adapter may be removed from the circuit, rinsed with water and reinserted into the circuit. To prevent moisture from draining into the sample tubing, ensure that the sampling tube exits from the top of the airway adapter, not its bottom or sides. See Figure 6.

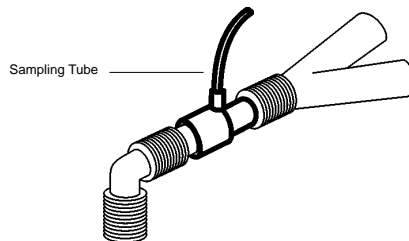


Figure 6

- Check that connections have been made correctly by verifying the presence of a proper capnogram on the R Series display.

## Applying a Nasal or Nasal/Oral Cannula

The nasal and nasal/oral cannulas are intended for monitoring EtCO<sub>2</sub> in non-intubated patients.

Oral/nasal sampling cannulas should be used on patients who are prone to mouth breathing, since most (if not all) of the CO<sub>2</sub> is exhaled through the mouth. If a standard nasal CO<sub>2</sub> sampling cannula is used on such patients, the EtCO<sub>2</sub> values and capnogram displayed will be substantially lower than the actual CO<sub>2</sub> levels present in the patient's expired breath.

---

**Caution** The disposable nasal and nasal/oral cannula sets are intended for single patient use. Do NOT reuse or sterilize the cannula, as system performance will be compromised.

---

1. Remove the cannula from the package. Verify that the cannula is clean, dry, and undamaged. Replace if necessary.
2. Attach the cannula's sample cell to the sample cell receptacle on the LoFlo module, and ensure that it clicks into place.
3. If the unit displays either of the following messages take the appropriate action.

If you see this message:	Take this action:
CHECK CO <sub>2</sub> LINE	<p>Verify that the sample cell is plugged into the module and seated properly.</p> <p>Verify that neither the sample line nor the exhaust tube are blocked, kinked, or pinched. If the sample line, or exhaust tube is blocked or otherwise compromised for 15 seconds, this message will appear. The pump will shut off after 2 minutes if the condition that caused the message is not cleared. To restart the pump, correct the blockage, then remove and reinsert the sample cell into the sample cell receptacle.</p> <p>If the problem persists, replace the sample line.</p>
CHECK CO <sub>2</sub> MODULE	<p>Check that module cable is plugged in and seated properly.</p> <p>Check that module is not exposed to excessive heat.</p> <p>If problem persists, replace module.</p>

4. Place the nasal cannula onto the patient as shown in Figure 7.

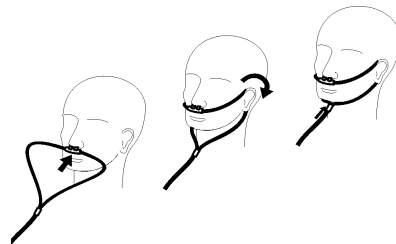


Figure 7

5. Place the oral/nasal cannula onto the patient as shown in Figure 8.



Figure 8

## Cleaning the CAPNOSTAT 5 CO<sub>2</sub> Sensor and LoFlo Module

The outside of the sensor or module may be cleaned and disinfected by wiping with 70% isopropyl alcohol, a 10% bleach solution, or mild soap.

After cleaning, wipe with a clean, water-dampened cloth to rinse. Dry before use.

## Cleaning Reusable Airway Adapters

Reusable airway adapters may be cleaned by rinsing in a warm soapy solution, followed by soaking in a liquid disinfectant such as 70% isopropyl alcohol, a 10% bleach solution, Cidex<sup>®</sup> or System 1<sup>®</sup> (refer to the disinfectant manufacturer's instructions for use). Adapters should then be rinsed with sterile water and dried.

The adult reusable airway adapter may be autoclaved at 121° C (250°F) for 20 minutes, unwrapped.

**Note:** The Neonatal reusable airway adapter cannot be autoclaved.

Before reusing the adapter, ensure the windows are dry and residue-free, and that the adapter has not been damaged during handling or by the cleaning process.

## How EtCO<sub>2</sub> is Displayed

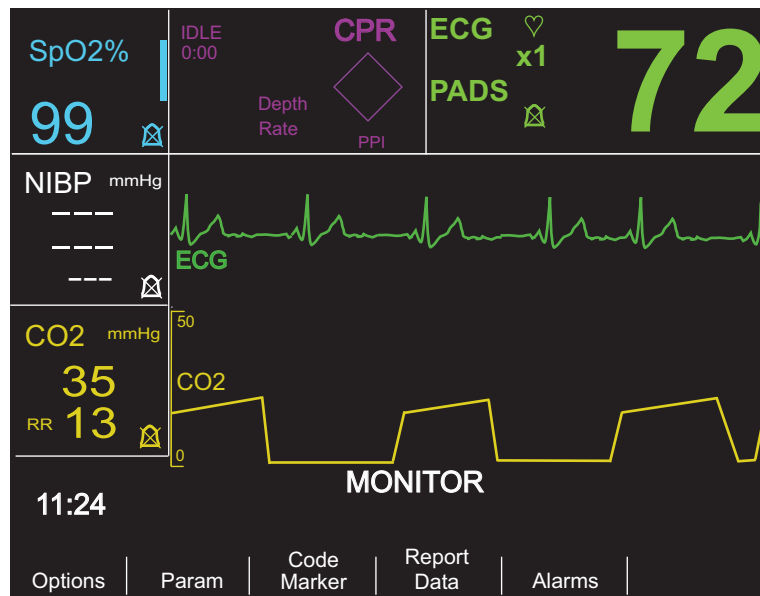
The R Series unit displays the numeric EtCO<sub>2</sub> value in units of mmHg, unless configured for percent or kPa. Refer to the *R Series Configuration Guide* (Part No. 9650-1201-01) for instructions on how to configure alternate units of measure. The unit also displays the number of breaths per minute, labeled "RR" for respiration rate. In addition, a capnogram may be displayed using the **Trace 2** or **Trace 3** softkey.

## Displaying the Capnogram Waveform

The R Series unit can display 1, 2 or 3 waveforms in Monitor, Defib, or Manual (BLS/Plus models) mode, as long as the defibrillator is not charging or ECG analysis is not in progress. The unit displays only 1 or 2 waveforms in Pacer mode.

**Note:** If you don't see the CO<sub>2</sub> display box on the monitor, check the sensor cable connection to the R Series unit. The CO<sub>2</sub> display box is not displayed if the sensor is not connected to the unit. Once the box is displayed, after power-on, it remains displayed even if the sensor is disconnected from the unit.

With EtCO<sub>2</sub> monitoring, the unit can display a capnogram below the ECG trace for a visual indicator of the moment-by-moment CO<sub>2</sub> values. The unit displays the capnogram at half the speed of the ECG display, and provides 8 or 10 seconds of data, depending on the setup.



The unit removes the third waveform from the display when the user presses the **CHARGE**, **ANALYZE**, or **ENERGY SELECT** buttons, or the **Sync On/Off** softkey.

To cycle the display from the capnogram to other waveforms (**SpO<sub>2</sub>**, **CPR**, or **Filt ECG**) press the **Options** softkey, then the **Traces** softkey. Select **Trace 2** or **Trace 3** and then the desired waveform. Press **Off** to remove any additional waveforms.

Use the **Zoom** softkey from the EtCO<sub>2</sub> submenu to adjust the waveform display size. Numbers shown on the left side of the capnogram display indicate the scaling.

## Physiological Monitoring

The physiological monitoring menu includes the following softkeys: **Options**, **Param**, **Code Marker**, **Report Data**, and **Alarms**.

### Param Softkey

When you press the **Param** softkey, the following softkeys are displayed: **ECG**, **SpO<sub>2</sub>**, **NIBP**, **CO<sub>2</sub>**, and **Return**.

**Note:** **SpO<sub>2</sub>**, **NIBP**, and **CO<sub>2</sub>** will only appear if these options are installed on your unit.



Press the **Return** softkey to return to the physiological monitoring menu.

Selecting the **CO<sub>2</sub>** parameter causes the following softkeys to appear: **Zero**, **Average**, **Comp.**, **Zoom**, **Disable EtCO<sub>2</sub>** (or **Enable EtCO<sub>2</sub>**), and **Return**.



The **Zoom** softkey will only appear if a capnogram is currently displayed.

Pressing the **Disable EtCO<sub>2</sub>** softkey puts the sensor into the power saving sleep mode. Pressing **Enable EtCO<sub>2</sub>** softkey takes the sensor out of sleep mode and turns the heater on for normal operation.

Press the **Return** softkey to return to the physiological monitoring menu.

## Zero Softkey

Adapter zeroing should be performed whenever you switch between reusable and disposable adapters, or if a CAPNOSTAT 5 CO<sub>2</sub> sensor is being connected to the unit for the first time. Module zeroing may be necessary if the unit displays the message *ZERO CO<sub>2</sub> MODULE*. Adapter zeroing may also be necessary if the unit displays *ZERO CO<sub>2</sub> ADAPTER*.

**Note:** Do not attempt zeroing for 20 seconds after removing the adapter or cannula from the patient's airway. This time allows any CO<sub>2</sub> remaining in the adapter or cannula to dissipate before zeroing. Do not attempt to zero while the adapter or cannula is in the patient's airway. Zeroing with CO<sub>2</sub> in the adapter or cannula can lead to inaccurate measurements and/or other error conditions. If you attempt zeroing while CO<sub>2</sub> remains in the adapter or cannula, the time required to zero may be increased. If zeroing cannot be completed, the message *ZERO FAILED* will be displayed. If this occurs, clear any occlusion in the adapter or cannula, remove any source of CO<sub>2</sub>, wait 20 seconds, and try zeroing again.

Press the **Zero** softkey to initiate adapter or module zeroing.

The unit displays the *ZEROING CO<sub>2</sub> ADAPTER* or *ZEROING CO<sub>2</sub> MODULE* message during the zeroing process, which is typically finished in 15-20 seconds.

The unit displays the *ZERO DONE* message when the zeroing process is complete.

The unit displays the *ZERO FAILED* message if the zeroing process did not complete successfully. If this occurs, clear any occlusion in the adapter or sample line, remove any source of CO<sub>2</sub>, and try zeroing again.

Press the **Return** softkey to return to the main menu.

## Zoom Softkey

The **Zoom** softkey will only appear if a capnogram is currently displayed. Select the full scale range for the displayed capnogram by scrolling among the different zoom levels. Zoom levels change with each press of the **Zoom** softkey. They are as follows:

- 0-12.5 mmHg
- 0-25 mmHg
- 0-50 mmHg
- 0-75 mmHg

- 0-100 mmHg
- 0-150 mmHg

If the unit is using kPa or %, the scales are 0-1.7, 0-3.3, 0-6.6, 0-10, 0-13.3, and 0-20.0. (Refer to the *R Series Configuration Guide* for instructions on how to configure alternate units of measure.)

## Average Softkey

The R Series unit provides 3 different time periods over which EtCO<sub>2</sub> values are averaged: 1 breath, 10 seconds (default), and 20 seconds.

The user can select the averaging period by pressing the **Average** softkey. When the **Average** softkey is pressed, the unit displays the selections.



Press the **1 breath**, **10 secs** or **20 secs** softkey for the desired time period.

## RR Filter Enable/Disable

The respiration rate filter makes respiration rate counting more accurate in the presence of artifact, and is only valid when the LoFlo module is in use. Pressing the:

- **RR Filter Enable** softkey turns the respiration rate filter on.
- **RR Filter Disable** softkey turns the respiration rate filter off.

Note that when the RR filter is in use, the R Series adapts more slowly to sudden changes in respiratory rate.

Press the **Return** softkey to return to the main menu.

## Comp. Softkey

The R Series unit can compensate for elevated levels of oxygen and/or the presence of nitrous oxide. Oxygen compensation should be activated when oxygen levels in excess of 60% are present in the airway circuit. Nitrous oxide compensation should be activated when nitrous oxide is present in the airway circuit. If the concentration of oxygen in the breathing circuit exceeds 60% and nitrous oxide is in use, both O<sub>2</sub> and N<sub>2</sub>O should be activated.

When the **Comp** softkey is pressed, the unit displays the **None**, **O<sub>2</sub>**, **N<sub>2</sub>O**, **O<sub>2</sub>&N<sub>2</sub>O**, and **Return** softkeys.



The O<sub>2</sub> selection turns oxygen compensation on and displays an asterisk in the upper left of the CO<sub>2</sub> box. The N<sub>2</sub>O selection turns nitrous oxide compensation on and displays an asterisk (\*) to the right of the O<sub>2</sub> asterisk. The None selection turns all compensations off and eliminates the asterisks from the display.

The O<sub>2</sub>&N<sub>2</sub>O selection turns oxygen and nitrous oxide compensation on. The unit displays two asterisks (\* \*) in the upper left of the CO<sub>2</sub> box to indicate compensation for both oxygen and

nitrous oxide. The left asterisk indicates oxygen compensation is active and the right asterisk indicates nitrous oxide compensation is active.

Press the **Return** softkey to return to the main menu.

## Alarms

The R Series EtCO<sub>2</sub> option provides user programmable “out-of-range” alarms for both EtCO<sub>2</sub> and respiration rate.

**Note:** The EtCO<sub>2</sub> and respiration rate alarms cannot be enabled or disabled separately. Enabling the EtCO<sub>2</sub> alarms enables both EtCO<sub>2</sub> and respiration rate alarm functions; disabling EtCO<sub>2</sub> or respiration rate alarms disables both functions. See the *R Series Operator’s Guide* for details on enabling, disabling, and suspending alarm functions on the R Series unit.

When the EtCO<sub>2</sub> and respiration rate alarm states are set to AUTO, the unit automatically sets the lower and upper limits for EtCO<sub>2</sub> and respiration rate. The unit sets the upper and lower alarm limits to +/- 25% of the patient’s currently measured CO<sub>2</sub> value. If the EtCO<sub>2</sub> value is greater than 40 mmHg (equivalent to 5.3 kPa or 5.3% at a barometric pressure of 760 mmHg), then 10 mmHg (1.3 for kPa or %) is added and subtracted from the current reading to set the upper and lower limits. The auto alarm limits are set only if valid measurements are present for the vital sign.

For the automatic respiration rate alarm limits, the unit sets the upper and lower limits for respiration by adding and subtracting the values shown in the following table to/from the patient's current breath rate.

Respiration Limits (Auto)		
Respiration Rate Average	High Limit	Low Limit
1-15 breaths/min.	+7 breaths/min.	-50% value
16-40 breaths/min.	+10 breaths/min.	-7 breaths/min.
> 40 breaths/min.	+15 breaths/min.	-10 breaths/min.

See “Default Settings” on page 21 for low and high alarm limit default values and ranges.

## Recorder Operation

If EtCO<sub>2</sub> measurements have been taken, press the RECORDER button to print a stripchart that includes the following values across the top part of the paper:

- Date and time
- ECG lead and size
- Heart rate
- EtCO<sub>2</sub> value
- Respiration rate

The recorder runs continuously until the button is pressed again. If selected, the capnogram is also printed at a fixed scale of 40 mmHg/cm or 5.3 kPa/cm. All waveforms printed by the recorder are delayed by 6 seconds relative to their occurrence.

## Check Out Procedures

The following procedures verify that the EtCO<sub>2</sub> option is functioning properly.

### Mainstream EtCO<sub>2</sub> (CAPNOSTAT 5 CO<sub>2</sub> Sensor)

1. Connect the CAPNOSTAT 5 CO<sub>2</sub> sensor cable to the yellow EtCO<sub>2</sub> connector at the back of the R Series unit.
2. Connect an airway adapter to the CAPNOSTAT 5 CO<sub>2</sub> sensor.
3. Turn the selector switch to **MONITOR** mode (**ON** for BLS/Plus units and select **Manual** mode).  
If the CO<sub>2</sub> box displays **DISABLED**, enable the sensor by pressing the **Param** softkey, then the **CO<sub>2</sub>** softkey, then the **Enable EtCO<sub>2</sub>** softkey.
4. Wait for the CO<sub>2</sub> sensor to warm up. The message *CO<sub>2</sub> WARM UP* is displayed for approximately one minute.
5. Perform a zero procedure if necessary (see “Zeroing the Mainstream CAPNOSTAT 5 CO<sub>2</sub> Sensor/Airway Adapter” on page 7).
6. Breathe normally into the adapter.
7. Verify that the unit displays appropriate readings in the EtCO<sub>2</sub> display area of the monitor.
8. With alarms enabled, verify that the patient alarms are functional by adjusting the high and low limits until the unit:
  - Emits a continuous audio tone.
  - Highlights the alarming parameter’s value and flashes the alarm symbol on the display.

### Sidestream EtCO<sub>2</sub> (LoFlo Module)

Use an Adult/Pediatric Airway Adapter kit when performing this procedure.

1. Connect the LoFlo module cable to the EtCO<sub>2</sub> connector at the back of the R Series unit.
2. Insert the sample cell into the LoFlo module sample cell receptacle.
3. Turn the selector switch to **MONITOR** mode (**ON** for BLS/Plus units and select **Manual Mode**), and wait approximately one minute while the module warms to operating temperature (unit displays *WARM UP* message).
4. Perform a zero procedure if necessary (see “Zeroing the LoFlo CO<sub>2</sub> Module/Sample Cell” on page 11).
5. Breathe normally into the adapter.
6. Verify that the unit displays EtCO<sub>2</sub> readings in the EtCO<sub>2</sub> display area of the monitor.
7. Verify the capnogram is displayed by pressing the **Options** softkey, then the **Traces** softkey.
8. With alarms enabled, verify that the patient alarms are functional by adjusting the high and low limits until the unit:
  - Emits a continuous audio tone.
  - Highlights the alarming parameter’s value and flashes the alarm symbol on the display.



## Default Settings

When the unit is turned on, the following default EtCO<sub>2</sub> settings are automatically selected and remain in operation until changed.

Parameter	Default Setting	Range
Averaging Mode	10 seconds	1 breath 10 seconds 20 seconds
High EtCO <sub>2</sub> Alarm Limit	55 mmHg 7.2% 7.3 kPa	5 - 100 mmHg, OFF 0.6 - 13.1%, OFF 0.6 -13.3 kPa, OFF
Low EtCO <sub>2</sub> Alarm Limit	25 mmHg 3.2% 3.3 kPa	0 - 95 mmHg, OFF 0 - 12.5%, OFF 0 -12.6 kPa, OFF
High Respiration Rate Alarm Limit	120 respirations per minute	5 - 150 respirations per minute, OFF
Low Respiration Rate Alarm Limit	5 respirations per minute	0 - 100 respirations per minute, OFF

**Note:** The power-on default settings for the capnogram waveform scale and CO<sub>2</sub> compensation are set in System Configuration, as are the power-on default settings for alarm limits. See the *R Series Configuration Guide* for more information.

## EtCO<sub>2</sub> Accessories

The following table lists the accessories available for the R Series mainstream EtCO<sub>2</sub> monitoring option.

**Table 1-1. CAPNOSTAT 5 Mainstream CO<sub>2</sub> Accessories**

Accessory	REF	Application
CAPNOSTAT 5 CO <sub>2</sub> Sensor and Cable	8000-0312-01	Reusable
SPU* Pediatric/Adult Airway Adapter	8000-0260-01	Single patient use, for ET tube sizes > 4.0 mm
SPU* Neonatal/Pediatric Airway Adapter	8000-0261-01	Single patient use, for ET tube sizes ≤ 4.0 mm
Reusable Adult Airway Adapter	8000-0262-01	Reusable, for ET tube sizes > 4.0 mm
Reusable Neonatal/Pediatric Airway Adapter	8000-0263-01	Reusable, for ET tube sizes ≤ 4.0 mm
SPU* Pediatric/Adult Airway Adapter with Mouthpiece	8000-0265-01	Single patient use, for non-intubated patients
CAPNO <sub>2</sub> mask, Large Adult	8000-0761	SPU, for non-intubated large adults
CAPNO <sub>2</sub> mask, Standard Adult	8000-0760	SPU, for non-intubated adults
CAPNO <sub>2</sub> mask, Pediatric	8000-0762	SPU, for non-intubated adults pediatric patients

\* SPU = Single Patient Use

**Table 1-2. LoFlo Sidestream CO<sub>2</sub> Accessories**

Accessory	REF	Application
LoFlo Module and Cable	8000-0367	
Nasal CO <sub>2</sub> Sampling Cannula, Adult	8000-0351	SPU, Nasal CO <sub>2</sub> sampling only (adult)
Nasal CO <sub>2</sub> Sampling Cannula, Pediatric	8000-0352	SPU, Nasal CO <sub>2</sub> sampling only (pediatric)
Nasal CO <sub>2</sub> Sampling Cannula, Infant	8000-0353	SPU, Nasal CO <sub>2</sub> sampling only (neonate)
Oral/Nasal CO <sub>2</sub> Sampling Cannula, Adult	8000-0354	SPU, Oral/Nasal CO <sub>2</sub> sampling only (adult)
Oral/ Nasal CO <sub>2</sub> Sampling Cannula, Pediatric	8000-0355	SPU, Oral/Nasal CO <sub>2</sub> sampling only (pediatric)
Nasal CO <sub>2</sub> Sampling with O <sub>2</sub> Delivery Cannula, Adult	8000-0356	SPU, Nasal CO <sub>2</sub> sampling with O <sub>2</sub> delivery (adult)
Nasal CO <sub>2</sub> Sampling with O <sub>2</sub> Delivery Cannula, Pediatric	8000-0357	SPU, Nasal CO <sub>2</sub> sampling with O <sub>2</sub> delivery (pediatric)
Oral/Nasal CO <sub>2</sub> Sampling with O <sub>2</sub> Delivery Cannula, Adult	8000-0358	SPU, Oral/Nasal CO <sub>2</sub> sampling with O <sub>2</sub> delivery (adult)
Oral/Nasal CO <sub>2</sub> Sampling with O <sub>2</sub> Delivery Cannula, Pediatric	8000-0359	SPU, Oral/Nasal CO <sub>2</sub> sampling with O <sub>2</sub> delivery (pediatric)
Adult/Pediatric Airway Adapter Kit	8000-0362	SPU, for ET tube sizes > 4.0 mm
Adult/Pediatric Airway Adapter Kit with Nafion tubing	8000-0363	SPU, for ET tube sizes > 4.0 mm
Pediatric/Infant Airway Adapter Kit	8000-0361	SPU, for ET tube sizes ≤ 4.0 mm
Pediatric/Infant Airway Adapter Kit with Nafion tubing	8000-0364	SPU, for ET tube sizes ≤ 4.0 mm

\* SPU = Single Patient Use

**Note:** Components of this product and its associated EtCO<sub>2</sub> accessories that make patient contact are free of latex.

**Note:** The CAPNOSTAT 5 and its accessories are covered by the following US patents:

- 5,146,092
- 5,153,436
- 5,369,277
- 5,616,923
- 5,793,044
- D490,332
- D501,802
- 5,693,944
- 6,935,338
- 6,954,702
- 7,004,168
- 7,059,322
- 7,121,134
- 7,291,851
- 7,294,839

Other patents pending.

# Messages and Troubleshooting

The following three tables list the messages that may appear on the R Series unit, possible causes, and the action(s) to take if the message indicates a problem. You should become thoroughly familiar with this information before monitoring patients.

COMMON MESSAGES		
Message/Symptom	Possible Cause(s)	Recommended Action(s)
---- (dashed lines in EtCO <sub>2</sub> field)	<p>After a defibrillation discharge, the numeric value displays as "----" for up to 10 seconds.</p> <p>When the respiration rate is zero, the numeric CO<sub>2</sub> value will display "--". When the respiration rate is greater than zero, the actual CO<sub>2</sub> numeric value will be displayed.</p> <p>The EtCO<sub>2</sub> module is warming up (up to 1 minute).</p> <p>Cable not plugged in.</p> <p>Cable defective.</p>	<p>None, normal operation.</p> <p>Check/replace sensor or module.</p>
---- (dashed lines at top of capnograph waveform)	The scale value setting is incorrect. CO <sub>2</sub> higher than scale limits was detected.	Adjust to higher scale setting using the Zoom softkey.
CAL BARO. PRESSURE	Barometric pressure reading is out of range.	Calibrate the barometric pressure as described in the <i>R Series Service Manual</i> .
CO2 COMM ERROR	There is no communication from the EtCO <sub>2</sub> module or sensor.	<p>Turn R Series unit off, then on again to reset.</p> <p>Try another EtCO<sub>2</sub> sensor.</p> <p>If the problem persists, return sensor and/or unit for service.</p>
CO2 DEVICE NOT READY	<p>The zero operation cannot be initiated because:</p> <ul style="list-style-type: none"> <li>• The sensor or module is still warming up.</li> <li>• No sensor or module is attached to the unit.</li> <li>• The sample cell is not plugged into the module.</li> <li>• Zeroing was attempted within 20 seconds of a detected breath.</li> </ul>	<p>Wait for sensor or module to warm up.</p> <p>Attach sensor or module to the unit.</p> <p>Plug sample cell into sample cell receptacle on module.</p>
CO2 OUT OF RANGE (dashed lines for CO <sub>2</sub> )	The calculated CO <sub>2</sub> value is greater than 150 mmHg.	If error persists, perform a mainstream airway adapter or module zero, as described in "Zeroing the Mainstream CAPNOSTAT 5 CO <sub>2</sub> Sensor/Airway Adapter" on page 7 and "Zeroing the LoFlo CO <sub>2</sub> Module/Sample Cell" on page 11.
CO2 UNIT ERROR	The EtCO <sub>2</sub> sensor or module has detected a hardware error.	<p>Check that the sensor is properly plugged in. Reinsert the sensor. Turn R Series unit off, then on again to reset. Perform a mainstream airway adapter or module zero, as described in "Zeroing the Mainstream CAPNOSTAT 5 CO<sub>2</sub> Sensor/Airway Adapter" on page 7 and "Zeroing the LoFlo CO<sub>2</sub> Module/Sample Cell" on page 11.</p> <p>If the problem persists, contact Technical Support.</p>

<b>COMMON MESSAGES (continued)</b>		
<b>Message/Symptom</b>	<b>Possible Cause(s)</b>	<b>Recommended Action(s)</b>
<i>CO<sub>2</sub> WARM UP</i>	The mainstream sensor or LoFlo module is warming up. This may take up to 5 minutes.	Wait for sensor or module to warm up. If the message persists more than 5 minutes, replace the sensor.
<i>ZERO DONE</i>	The sensor/adapter zero or the LoFlo module zero is finished.	No action required.
<i>ZERO FAILED</i>	The zero operation did not complete successfully.	Clear the occlusion, remove any source of CO <sub>2</sub> , and try zeroing again. If problem persists, contact Technical Support.

<b>MAINSTREAM MESSAGES</b>		
<b>Message/Symptom</b>	<b>Possible Cause(s)</b>	<b>Recommended Action(s)</b>
<i>CHECK CO<sub>2</sub> ADAPTER</i>	This is usually caused when the airway adapter is removed from the CAPNOSTAT 5 CO <sub>2</sub> sensor, or when there is an optical blockage on the windows of the airway adapter.  It may also be caused by not having performed an adapter zero after changing the adapter type (single patient use vs. reusable).	Clean the airway adapter and reattach it. If the problem persists or the adapter type was changed, perform a mainstream airway adapter zero as described in "Zeroing the Mainstream CAPNOSTAT 5 CO <sub>2</sub> Sensor/Airway Adapter" on page 7.
<i>CHECK CO<sub>2</sub> SENSOR</i>	The CAPNOSTAT 5 CO <sub>2</sub> sensor cable is not properly plugged in or is over temperature.	Check that the sensor cable is plugged in and properly seated in the connector.  Check that the sensor is not exposed to excessive heat.  If the problem persists, replace the sensor.
<i>CO<sub>2</sub> DEVICE NOT READY</i>	There is CO <sub>2</sub> in the airway adapter when attempting to zero.  Zeroing was attempted within 20 seconds of previous zero operation.	Remove airway adapter from CO <sub>2</sub> source including the patient's, and your own exhaled breaths, and ventilator exhaust valves.  Wait up to 20 seconds before retrying a mainstream airway adapter zero, as described in "Zeroing the Mainstream CAPNOSTAT 5 CO <sub>2</sub> Sensor/Airway Adapter" on page 7.
<i>ZERO CO<sub>2</sub> ADAPTER</i>	Negative CO <sub>2</sub> detected. May be caused by a sensor that was zeroed with CO <sub>2</sub> in the airway, or by an optical blockage of the airway adapter.	Check the airway adapter and clean if necessary. Perform a mainstream airway adapter zero as described in "Zeroing the Mainstream CAPNOSTAT 5 CO <sub>2</sub> Sensor/Airway Adapter" on page 7.
<i>ZEROING CO<sub>2</sub> ADAPTER</i>	Adapter zeroing is in progress.	Wait for the adapter zeroing to finish.

<b>SIDESTREAM MESSAGES</b>		
<b>Message/Symptom</b>	<b>Possible Cause(s)</b>	<b>Recommended Action(s)</b>
<i>CHECK CO2 LINE</i>	Sample line blockage or damage. Sample line is kinked or pinched. Exhaust tube is blocked.	Verify that the sample line is plugged into the module and seated properly. Verify that neither the sample line nor the exhaust tube are blocked, kinked, or pinched. Verify that the airway adapter is not blocked. If the sample line, exhaust tube, or the airway adapter is blocked or otherwise compromised for 15 seconds, this message will appear. The pump will shut off after 2 minutes if the condition that caused the message is not cleared. To restart the pump, correct the blockage, then remove and reinsert the sample cell into the sample cell receptacle. If the problem persists, replace the sample line.
<i>CHECK CO2 MODULE</i>	Module not properly plugged in. Module over temperature.	Check that module cable is plugged in and seated properly in the connector. Check that module is not exposed to excessive heat. If problem persists, replace module.
<i>CO2 IN LINE: WAIT</i>	CO <sub>2</sub> in cannula/adapter when attempting to zero. Sample line disconnected while zero in progress.	Wait up to 20 seconds before retrying module zero. Remove adapter or cannula tip from CO <sub>2</sub> source including the patient's - and your own - exhaled breaths, and ventilator exhaust valves.
<i>ZERO CO2 MODULE</i>	Negative CO <sub>2</sub> detected. May be caused by a module that was zeroed with CO <sub>2</sub> in the sample line.	Perform module zero as described in "Zeroing the LoFlo CO <sub>2</sub> Module/Sample Cell" on page 11.
<i>ZEROING CO2 MODULE</i>	Module zeroing in progress.	Wait for module zeroing to finish.

## Specifications

This section summarizes the specifications of the R Series End Tidal Carbon Dioxide (EtCO<sub>2</sub>) option.

	<b>CAPNOSTAT 5® CO<sub>2</sub> Sensor</b>	<b>LoFlo™</b>
Transducer Type	Mainstream	Sidestream
Principle of Operation	Non-Dispersive Infrared (NDIR) single beam optics, dual wavelength, no moving parts.	
Warm Up Time	Full specifications within 2 minutes at an ambient temperature of 25° C. Capnogram in 15 seconds.	
EtCO <sub>2</sub> Measurement Range	0 - 150 mmHg 0 - 20% 0 - 20 kPa	
EtCO <sub>2</sub> Accuracy (at 760 mmHg, ambient temperature of 25°C)	0 - 40 mmHg, ±2 mmHg 41 - 70 mmHg, ±5% of actual 71 - 100 mmHg, ±8% of actual 101 - 150 mmHg, ±10% of reading  (At respiration rates > 80 breaths per minute, all ranges are ±12% of actual.)	
EtCO <sub>2</sub> Resolution	0.1 mmHg 0 - 69 mmHg 0.25 mmHg 70 - 150 mmHg	
EtCO <sub>2</sub> Stability	Short-Term Drift: Drift over four hours ≤ 0.8 mmHg.  Long-Term Drift: Accuracy specification will be maintained over a 120 hour period after zeroing.	
EtCO <sub>2</sub> Noise	RMS noise of the sensor ≤ 0.25 mmHg at 7.5% CO <sub>2</sub> .	RMS noise of the sensor ≤ 0.25 mmHg at 5% CO <sub>2</sub> .
EtCO <sub>2</sub> Rise Time (10-90%)	< 60 ms (Adult/pediatric adapters) < 60 ms (Infant/pediatric adapters)	< 3 seconds (includes transport and rise time)
Respiration Rate Range	2 - 150 breaths per minute	
Respiration Rate Accuracy	±1 breath per minute. Verified using a solenoid test setup to deliver a square wave of known CO <sub>2</sub> concentration to the device. 5% and 10% CO <sub>2</sub> concentrations were used and respiration rate was varied over the range of the device. Pass/Fail criteria was comparison of the respiratory rate output from the sensor to the frequency of the square wave. EtCO <sub>2</sub> measurements at those rates were compared to the CO <sub>2</sub> readings under static flow conditions.	
Sample Flow Rate	N/A	50 ml/min ±10 ml/min
Compensations	Barometric pressure 400 - 850 mmHg (automatic). Operator selectable O <sub>2</sub> /N <sub>2</sub> O compensation.	
EtCO <sub>2</sub> Alarm Limits	User selectable, High 5 - 100 mmHg, Low 0 - 95 mmHg, OFF.	
Respiration Rate (RR) Alarm Limits	User selectable, High 5 - 150 respirations per minute, Low 0 - 100 respirations per minute, OFF.	
Halogenated Agents	Specification allows for halogenated anesthetic agents that may be present at normal clinical levels. The presence of Desflurane in the exhaled breath beyond normal values (5-6%) may positively bias carbon dioxide values by up to an additional 2-3 mmHg.	
Airway Adapter Deadspace	Adult < 5 cc Infant < 1.0 cc	Adult <7.3 cc Maximum Pediatric/Infant < 1.0 cc

	<b>CAPNOSTAT 5® CO<sub>2</sub> Sensor</b>	<b>LoFlo™</b>
Environmental (sensor or module)	Operating Temperature: 0° C to 40° C Storage and Shipping Temperature: -40° C to 70° C  The R Series unit may not perform to specifications when stored at the upper or lower extreme limits of storage temperature and immediately put into use.	
Electromagnetic Immunity	AAMI DF-80:2003, IEC 60601-1-2, 10 V/m	
Software Hazards	Minimized by compliance with EN60601-1-4	
Operating Time with EtCO <sub>2</sub> and SpO <sub>2</sub> Options	For a new fully charged battery pack at 20° C (68° F): <ul style="list-style-type: none"> <li>• 90 defibrillator discharges at maximum energy (200 J), or</li> <li>• 3.0 hours minimum of continuous ECG monitoring, or</li> <li>• 2.5 hours of continuous ECG monitoring/pacing at 60 mA, 70 beats per minute.</li> </ul>	

---

(This page intentionally left blank.)

---



**ZOLL**®

AED Pro®

AED Pro® A-W

# Operator's Guide



The issue date for the AED Pro Operator's Guide (REF 9650-0350-01 Rev. L) is **December, 2017**.

If more than 3 years have elapsed since the issue date, contact ZOLL Medical Corporation to determine if additional product information updates are available.

Copyright © 2017 ZOLL Medical Corporation. All rights reserved. AED Plus, AED Pro, CPR-D-padz, M Series, Pedi-padz, PowerCharger, Real CPR Help, Rectilinear Biphasic, RescueNet, See-Thru CPR, Stat-padz, SurePower and ZOLL are trademarks or registered trademarks of ZOLL Medical Corporation in the United States and/or other countries.

All other trademarks and registered trademarks are property of their respective owners.

Caution: Federal law restricts this device to sale by or on the order of a licensed practitioner.



**ZOLL Medical Corporation**  
269 Mill Road  
Chelmsford, MA USA  
01824-4105

**EC REP** **ZOLL International Holding B.V.**

Newtonweg 18  
6662 PV ELST  
The Netherlands



0123

## Indication of use

The AED Pro system is indicated for use on victims of cardiac arrest with apparent lack of circulation as indicated by:

- Unconsciousness
- Absence of breathing, and
- Absence of pulse and other signs of circulation.

The device is also indicated for use when ECG monitoring is indicated to evaluate the patient's heart rate or ECG morphology. The AED Pro system is indicated for adult and pediatric patients.

## Contraindication of use

Never use the unit for defibrillation when the patient

- Is conscious
- Is breathing, or
- Has a detectable pulse or other sign of circulation.

## General Information

Federal (U.S.A.) law restricts this defibrillator to sale by or on the order of a physician.

---

---

# Table of Contents

## Indication of use

Contraindication of use .....	iii
General Information .....	iii

## Chapter 1 Product Overview

Defibrillation .....	1-2
Defibrillation Modes .....	1-2
Semiautomatic Mode Defibrillation and CPR Monitoring .....	1-2
Manual Mode Defibrillation .....	1-3
ECG Monitoring .....	1-3
Audio Recording .....	1-4
Nonrescue Mode .....	1-5
Data Transfer .....	1-5
Device Configuration .....	1-5
Standby State .....	1-5
Automatic Shutoff .....	1-5
Accessories .....	1-6
A-W Accessories .....	1-7
The Front Panel .....	1-8
Display Screen .....	1-10

## Chapter 2 Getting Started

Installing a Battery Pack .....	2-2
CHANGE BATTERY Warning .....	2-4
Preparing the Unit for Clinical Use .....	2-5
Performing a Self-Test .....	2-6
Automatic Self-Tests .....	2-6
Manual Self-Test .....	2-6
Preconnecting the Defibrillation Electrodes Cable .....	2-7
Messages .....	2-8

## Chapter 3 Semiautomatic Mode

Applying Defibrillation Electrode Pads .....	3-2
Applying Defibrillation Electrode Pads — Adult CPR-D-padz .....	3-3
Applying Defibrillation Electrode Pads — Adult CPR Stat-padz .....	3-5
CPR Monitoring with <i>CPR-D-padz and CPR Stat-padz</i> .....	3-6
Applying Defibrillation Electrode Pads — Adult <i>Stat-padz II</i> .....	3-7
Applying Defibrillation Electrode Pads — Infant/Child <i>Pedi-padz II</i> .....	3-8

Semiautomatic Defibrillation ..... 3-9  
     Start with CPR Option ..... 3-12  
     Messages in Semiautomatic Mode ..... 3-12

**Chapter 4 Manual Mode**

About Manual Mode..... 4-2  
 Switching to Manual Mode..... 4-3  
 Manual Defibrillation ..... 4-4  
 See-Thru CPR ..... 4-5  
 Messages in Manual Mode ..... 4-10

**Chapter 5 ECG Monitoring Mode**

About ECG Monitoring..... 5-2  
 ECG Electrode Placement..... 5-3  
 Applying ECG Electrodes ..... 5-4  
 Monitoring the ECG Rhythm..... 5-6  
     Monitoring with ECG Electrodes ..... 5-6  
     Monitoring with Defibrillation Electrodes ..... 5-7  
 Messages in ECG Monitoring Mode ..... 5-8

**Chapter 6 Nonrescue Mode**

Entering Nonrescue Mode ..... 6-2  
 Data Storage..... 6-3  
     Device History ..... 6-3  
     Patient Clinical Data ..... 6-3  
 Communicating with an External Device ..... 6-4  
     Setting Up Data Communications with an IrDA Connection ..... 6-4  
     Downloading Data to a USB Device ..... 6-4  
 Setting the Date and Time ..... 6-5  
 Device Configuration ..... 6-6  
 ZOLL Administration Software ..... 6-6  
     Installing ZOLL Administration Software ..... 6-6  
     RescueNet Code Review Software ..... 6-7  
 Messages in Nonrescue Mode ..... 6-8

**Chapter 7 Troubleshooting and Maintenance**

General Troubleshooting ..... 7-2  
 ECG Monitoring Troubleshooting..... 7-4  
 Defibrillator Troubleshooting ..... 7-5  
 Cleaning the Unit ..... 7-6  
 Optional Maintenance for Technical Professionals ..... 7-7

---

## Appendix A Specifications

Device Specifications.....	A-2
Battery Pack Specifications .....	A-6
Guidance and Manufacturer’s Declaration — Electromagnetic Compatibility .....	A-7
Electromagnetic Immunity Declaration (EID) .....	A-8
Rectilinear Biphasic Waveform Characteristics .....	A-11
Clinical Trial Results for the M Series Biphasic Waveform .....	A-14
Randomized Multicenter Clinical Trial for Defibrillation of Ventricular Fibrillation (VF) and Ventricular Tachycardia (VT) .....	A-14
Pre-Clinical Study .....	A-15
Published Clinical Data .....	A-16
ECG Analysis Algorithm Accuracy .....	A-17

## Appendix B Rechargeable Battery Packs

Managing Rechargeable Battery Packs .....	B-2
Recharging and Testing Battery Packs .....	B-2
Achieving Optimal Performance with Rechargeable Batteries .....	B-3

## Appendix C Configurable Settings

Descriptions of AED Pro Configurable Settings .....	C-2
---	-----





# Preface

---

The AED Pro<sup>®</sup> and AED Pro<sup>®</sup> A-W from ZOLL Medical Corporation is a portable, automated external defibrillator (AED) intended for use by trained rescuers to provide emergency defibrillation and to monitor patient ECG during treatment.

This Preface contains the following sections:

- “How To Use This Guide” on page vi
- “Safety Considerations” on page vii
- “Equipment” on page xi
- “Intended Use” on page xvi

## How To Use This Guide

The *AED Pro Operator's Guide* provides information that operators need for the safe and effective use and care of the AED Pro device. Before operating this device, be sure to read and understand all the information contained within.

This guide also describes device setup and maintenance procedures.

Separate chapters in this document describe use of the device in either semiautomatic or manual mode.

## Manual Updates

ZOLL Medical Corporation provides manual updates to inform customers of changes in device information and use. Customers should carefully review each update to understand its significance, and then file the update in its appropriate section within the manual for subsequent reference.

Product documentation is available through the ZOLL website at [www.zoll.com](http://www.zoll.com). From the Products menu, choose Product Documentation.

## Related Manuals

In addition to this manual, the following ZOLL publications provide information about this product and related products and accessories:

REF	Title
9650-0054-01	ZOLL Base PowerCharger 4x4 Operator's Manual
9650-0120-01	ZOLL Base PowerCharger 1x1 Operator's Manual
9651-0801-01	AED Pro Simulator Operator's Guide
9650-0535-01	SurePower™ Charger Station Operator's Guide
9650-0536-01	SurePower Battery Pack Guide

## Conventions

This guide uses the following conventions:

Within text, the names and labels for physical buttons and softkeys appear in **boldface** type (for example, “Press the **Shock** button or the **DISARM** softkey”).

This guide uses uppercase italics for audible prompts and for text messages displayed on the screen (for example, *DON'T TOUCH PATIENT, ANALYZING*).

---

**WARNING!** Warning statements alert you to conditions or actions that can result in personal injury or death.

---



---

**Caution** Caution statements alert you to conditions or actions that can result in damage to the unit.

---

---

## Safety Considerations



All operators should review these safety considerations before placing the AED Pro unit into service.

These operating instructions describe the functions and proper operation of the AED Pro unit. This manual does not substitute for a formal training course. Operators must obtain formal training from an appropriate authority before using this device for patient care.

Follow all recommended maintenance instructions. If a problem occurs, obtain service immediately. Do not use the device until it has been inspected by appropriate personnel.

There are no replaceable parts in this unit without the use of tools, and no user replaceable parts while the unit is in clinical operation on a patient.

Do not disassemble the unit. A shock hazard exists. Refer all problems to authorized service personnel.

The AED Pro unit is capable of delivering 200 joules. To completely deactivate the unit, turn it off and remove the battery pack.

To manually disarm a charged (or charging) defibrillator, do one of the following:

- Turn the unit off for at least 3 seconds.
- Press the **DISARM** softkey (manual mode only).

For safety, the AED Pro unit automatically disarms a fully charged defibrillator after 60 seconds in manual mode or 30 seconds in semiautomatic mode if the **Shock** button is not pressed.

## General

Proper operation of the unit and correct electrode placement are critical to obtaining optimal results. Operators must be thoroughly familiar with proper device operation.

The use of external defibrillation electrodes or adapter devices from sources other than ZOLL is not recommended. ZOLL Medical Corporation makes no representations or warranties regarding the performance or effectiveness of its products when used with defibrillation electrodes or adapter devices from other sources. Device failures attributable to the use of defibrillation electrodes or adapters not manufactured by ZOLL might void the warranty on the ZOLL equipment.

This device is protected against interference from radio frequency emissions typical of the two-way radios and cellular phones (digital and analog) used in emergency service or public safety activities. You should assess the device's performance in your typical operating environment to determine the likelihood of radio frequency interference (RFI) from high-power sources. Radio frequency interference can cause shifts in the monitor baseline, trace compression, changes to brightness of the display, or transient spikes on the screen.

The AED Pro unit might not perform to specifications when stored at the upper or lower extreme limits of storage temperature and then immediately put into use.

Do not use or stack the unit with other equipment. If the unit is used or stacked with other electrical equipment, verify proper operation before using it.

**MR Unsafe:** Keep the AED Pro defibrillator away from magnetic resonance imaging (MRI) equipment.

Do not use or place the unit in service if it beeps while turned off.

The use of accessories or cables other than those specified in this manual may result in increased emissions or decreased immunity of the AED Pro.

Do not use or place the unit in service if the Ready indicator (at the upper right of the front panel) shows a red “X”.

### **Defibrillation**

Emergency defibrillation should be performed only by appropriately trained, skilled personnel who are familiar with the operation of the equipment. The prescribing physician should determine what training, such as Advanced Cardiac Life Support (ACLS) or Basic Life Support (BLS) certification, is appropriate for operating this device.

### **ECG analysis**

A patient must be motionless during ECG analysis. Do not touch the patient during analysis. Cease all patient movement by stretcher or vehicle before beginning ECG analysis in semiautomatic mode.

### **Cardiopulmonary resuscitation (CPR)**

Before performing CPR, place the patient on a firm surface.

### **Battery care**

Keep a fully charged spare battery pack with the device at all times.

When the unit displays the message *CHANGE BATTERY*, immediately replace the battery pack with a fully charged one.

Regular use of a partially charged battery pack without fully recharging it between uses might permanently reduce the battery’s capacity and result in early failure.

Regularly test rechargeable battery packs. A rechargeable battery pack that does not pass its test could fail without warning.

Do not disassemble a battery pack or dispose of it in fire. Do not try to recharge a nonrechargeable battery pack. If mistreated, a battery pack might explode.

Dispose of battery packs in accordance with federal, state, and local regulations. Battery packs should be shipped to a reclamation facility for recovery of metal and plastic compounds as the proper method of waste management.

## **Operator Safety**



Do not use the unit near oxygen-rich atmospheres, flammable anesthetics, or other flammable agents (such as gasoline).

Do not use the unit within standing water.

Before discharging the defibrillator, warn everyone to stand clear of the patient.

Do not discharge the defibrillator except as indicated in the instructions. Discharge the defibrillator only when defibrillation pads are properly attached to the patient. Never discharge the unit with the defibrillation pads shorted together or in open air.

## Electrical shock

Before defibrillation, be sure to disconnect from the patient all electromedical equipment that is not defibrillation-protected. Keep electrodes away from all other equipment attached to the patient and from metal objects in contact with the patient.

During defibrillation, do not touch the bed, the patient, conductive material, or any equipment connected to the patient; a severe shock can result. To avoid hazardous pathways for the defibrillation current, do not allow exposed portions of the patient's body to touch any metal objects, such as a bed frame.

## Accessory equipment

The use of accessory equipment that does not comply with the equivalent safety requirements of the AED Pro device could reduce the level of safety of the resulting system. When selecting accessory equipment, consider the following:

- Use of the accessory in the patient vicinity
- Evidence that the safety certification of the accessory has been performed in accordance with the appropriate IEC (EN) 60601-1 and/or IEC (EN) 60601-1-1 harmonized national standards.

## Patient Safety



The AED Pro unit detects ECG electrical signals only and does not detect a pulse (effective circulatory perfusion). Always verify pulse and heart rate by physical assessment of the patient. Never assume that the display of a nonzero heart rate means that the patient has a pulse.

ECG rhythm analysis does not warn of patient asystole, which is not a shockable rhythm.

Do not connect the AED Pro to a PC or other device (via the USB port) while the unit's electrodes are still connected to the patient.

Disconnect the AED Pro from the patient before performing defibrillation with another defibrillator.

If the AED Pro shuts down or malfunctions during defibrillation of the patient with a different defibrillator, turn the AED Pro unit off and then back on, and continue normal use.

Check electrical leakage levels before use. Leakage current might be excessive if more than one monitor or other piece of equipment is connected to the patient.

Do not use this equipment in the presence of electrosurgery.

## Defibrillation pads and ECG electrodes

Check the expiration date on the electrode packaging. Do not use electrodes that have passed their expiration date.

Do not use defibrillation pads or ECG electrodes if the gel is dried or damaged; patient burns or poor quality ECG signals might result from using such electrodes.

Poor adherence or air pockets under defibrillation pads can cause arcing, skin burns, or reduced energy delivery. To minimize burning, apply freshly opened and undamaged defibrillation pads to clean and dry skin. Excessive body hair or wet, diaphoretic skin can inhibit electrode pad coupling (contact) with the skin. Clip excess hair and dry any moisture from the area where an electrode pad is to be attached.

To prepare for an emergency, keep the defibrillation electrode cable connected to the unit at all times, even when the unit is not in use.

Use only high-quality ECG electrodes. ECG electrodes are for monitoring only; you cannot use ECG electrodes for defibrillation.

### **Implanted pacemakers**

Do not place electrodes directly over an implanted pacemaker. Implanted pacemakers might cause the heart rate meter or ECG rhythm analysis to count the pacemaker rate during incidents of cardiac arrest or other arrhythmia. Carefully observe pacemaker patients. Check the patient's pulse; do not rely solely on heart rate meters. Patient history and physical examination are important factors in determining the presence of an implanted pacemaker.

## **Cautions**



Do not sterilize the device or the ECG monitoring cable.

Do not immerse any part of the device into water.

Do not use ketones (such as MEK or acetone) on the device.

Avoid using abrasives (including paper towels) on the display screen and IrDA port.

## **Restarting the Device**

Certain events require a restart of the AED Pro unit after it shuts off, encounters an error, or becomes inoperative. If such an event occurs, always try to restore device operation as follows before seeking alternative methods of patient monitoring or treatment:

1. Press and hold the **On/Off** button for 1 second to turn the unit off.
2. After the unit has shut down, wait at least 3 seconds.
3. Press and release the **On/Off** button to restart the unit.









## Equipment













Before unpacking the AED Pro unit, carefully inspect each shipping container for damage. If the container or cushioning material is damaged, keep it until you have checked the contents for completeness, and the unit has been tested for mechanical and electrical integrity.

Examine the unit for any signs of damage that might have occurred during shipping. Review the shipping list to ensure that you received all ordered items. If the contents are incomplete, if there is mechanical damage, or if the device does not pass its electrical self-test (as indicated by a red “X” in the Ready indicator after battery installation), contact the ZOLL Technical Service Department or the nearest ZOLL authorized representative. If the shipping container is damaged, notify the carrier also.













## Symbols Used on the Equipment

The following symbols might appear in this document or on the AED Pro unit, battery packs, electrodes, or shipping materials.

Symbol	Description
	Dangerous voltage.
	MR unsafe: keep away from magnetic resonance imaging equipment
	Attention, consult accompanying documents.
	Fragile, handle with care.
	Keep dry.
	This end up.
	Temperature limitation.
	<b>Conformité Européenne</b> Complies with medical device directive 93/42/EEC.

Symbol	Description
	Defibrillator-proof type BF equipment.
	Defibrillator-proof type CF equipment.
	Contains lead. Recycle or dispose of properly.
	Contains lithium. Recycle or dispose of properly.
	Keep away from open flame and high heat.
	Do not open, disassemble, or intentionally damage.
	Do not crush.
	Nonrechargeable battery.
	Do not discard in trash. Recycle or dispose of properly.
	Date of manufacture.
	Use by.
	Latex-free.



Symbol	Description
	Do not reuse.
	Do not fold.
	Not sterile.
	Nonionizing electromagnetic radiation.
	Manufacturer.
	Authorized representative in the European Community.
	Serial Number.
	Catalogue number.
	Consult instructions for use.
	Prescription only.
	Return to a collection site intended for waste electrical and electronic equipment (WEEE). Do not dispose of in unsorted trash.
	Class II equipment.

## FDA Tracking Requirements

U.S. Federal Law (21 CFR 821) requires the tracking of defibrillators. Under this law, owners of this device must notify ZOLL Medical Corporation if this product is

- received
- lost, stolen, or destroyed
- donated, resold, or otherwise distributed to a different organization

If any such event occurs, contact ZOLL Medical Corporation in writing with the following information:

1. Originator's organization – Company name, address, contact name, and contact phone number
2. Part number, model number, and serial number of the device
3. Disposition of the device (for example, received, lost, stolen, destroyed, distributed to another organization), new location and/or organization (if known and different from originator's organization) – company name, address, contact name, and contact phone number
4. Date when the change took effect

Please address the information to:

**ZOLL Medical Corporation**  
**Attn: Tracking Coordinator**  
**269 Mill Road**  
**Chelmsford, MA 01824-4105**

Fax: (978) 421-0025

Tel: (978) 421-9655

## Notification of Adverse Events

Under the Safe Medical Devices Act (SMDA), health care providers are responsible for reporting to ZOLL Medical Corporation, and possibly to the FDA, the occurrence of certain events.

These events, described in 21 CFR Part 803, include device-related death and serious injury or illness. In addition, as part of our Quality Assurance Program, ZOLL Medical Corporation requests to be notified of device failures or malfunctions. This information is required to ensure that ZOLL Medical Corporation provides only the highest quality products.

## Contacting Technical Service

The AED Pro unit is calibrated at the factory, and does not require periodic recalibration or adjustment. If a unit requires service, contact the ZOLL Technical Service Department.

Telephone: 1-800-348-9011 (within the U.S.A. only)  
1-978-421-9655

Fax: 1-978-421-0010

When requesting service, please provide the following information to the service representative:

- Unit serial number
- Description of the problem
- Department using the equipment and name of the person to contact
- Purchase order to allow tracking of loan equipment
- Purchase order for a unit with an expired warranty

### Returning a unit for service

Before sending a unit to the ZOLL Technical Service Department for repair, obtain a service request (SR) number from the service representative.

Remove the battery pack from the unit. Pack the unit with its cables in the original containers (if available) or equivalent packaging. Be sure the assigned service request number appears on each package.

For customers	Return the unit to
In the U.S.A.	ZOLL Medical Corporation 269 Mill Road Chelmsford, MA 01824-4105  Attention: Technical Service Department ( <i>SR number</i> )  Telephone: 1-800-348-9011
In Canada	ZOLL Medical Canada Inc. 1750 Sismet Road, Unit #1 Mississauga, Ontario L4W 1R6  Attention: Technical Service Department ( <i>SR number</i> )  Telephone: 1-866-442-1011
In other locations	The nearest authorized ZOLL Medical Corporation representative.  To locate an authorized service center, contact the International Sales Department at  ZOLL Medical Corporation 269 Mill Road Chelmsford, MA 01824-4105  Telephone: 1-978-421-9655

## Intended Use

The AED Pro unit is intended to defibrillate victims of ventricular fibrillation or pulseless ventricular tachycardia, for ECG monitoring, and for CPR monitoring of patients. The CPR monitoring function provides a metronome designed to encourage rescuers to perform chest compressions at the AHA/ERC recommended rate of 100 compressions per minute. Voice and visual prompts encourage a compression depth of at least 2 inches (5 cm) for adult patients.

## Intended Users

In semiautomatic mode, the AED Pro unit is intended to be used by rescuers and emergency care personnel who have completed training and certification requirements applicable to the use of a defibrillator where the operator controls delivery of shocks to the patient.

In manual mode, the AED Pro unit is intended to be used only by qualified medical personnel trained in Advanced Life Support skills.

In ECG monitoring mode, the AED Pro unit is intended to be used by personnel who are qualified by training in the use of the AED Pro device, basic life and/or advanced life support, or other physician-authorized emergency medical training.

## Defibrillator Precautions

Inappropriate defibrillation of a patient (for example, with no malignant arrhythmia) can precipitate ventricular fibrillation, asystole, or other dangerous types of arrhythmia.

Without proper application of electrode pads, defibrillation might be ineffective and cause burns, particularly when repeated shocks are necessary. Erythema or hyperemia of the skin under the defibrillation pads often occurs. This reddening effect, often enhanced along the perimeter of the pad, should diminish substantially within 72 hours.

### **Defibrillator output energy**

The AED Pro unit can deliver as much as 200 joules into a 50 ohm impedance. The energy delivered through the chest wall, however, is determined by the patient's transthoracic impedance.

# Chapter 1

## Product Overview

---

The AED Pro device provides the following clinical modes:

- Semiautomatic defibrillation with CPR monitoring
- Manual defibrillation
- ECG monitoring

To guide the operator through rescue protocols, the AED Pro unit issues instructions through text messages displayed on its screen and by voice prompts played through a speaker.

This chapter introduces the AED Pro unit, and contains the following sections:

- “Defibrillation” on page 1-2
- “Semiautomatic Mode Defibrillation and CPR Monitoring” on page 1-2
- “Manual Mode Defibrillation” on page 1-3
- “ECG Monitoring” on page 1-3
- “Audio Recording” on page 1-4
- “Nonrescue Mode” on page 1-5
- “Standby State” on page 1-5
- “Automatic Shutoff” on page 1-5
- “Accessories” on page 1-6
- “The Front Panel” on page 1-8

## Defibrillation

The AED Pro unit uses the ZOLL Rectilinear Biphasic™ waveform and ZOLL single-use defibrillation electrode pads for defibrillation.

Escalating energy levels for the first three shocks are preconfigured into the unit for adult and pediatric patients. (The unit selects the appropriate levels by detecting the type of defibrillation electrode pads in use.) After the first three shocks, all subsequent shocks are delivered at the same energy as the third shock.

The factory default energy levels in joules are as follows:

	First shock	Second shock	Third shock
Adult	120	150	200
Pediatric	50	70	85

These energies will be delivered by the AED Pro into a 50Ω patient load.

For more information, refer to Appendix C, “Configurable Settings”.

## Defibrillation Modes

The AED Pro unit can be manufactured to run in one of three defibrillation modes:

- Semiautomatic Mode Defibrillation with CPR Monitoring
- Manual Mode Defibrillation
- Semiautomatic Mode Defibrillation with CPR Monitoring and Manual Mode Override

## Semiautomatic Mode Defibrillation and CPR Monitoring

When the AED Pro unit is configured to run in semiautomatic mode or semiautomatic mode with manual mode override, the unit starts up in semiautomatic mode unless an AED Pro ECG cable is attached to the unit.

In semiautomatic mode, the unit analyzes the patient’s ECG through the defibrillation electrode pads attached to the patient. If the unit detects a shockable rhythm, it automatically charges to the appropriate (preconfigured) energy level. Once the defibrillator is fully charged, the **Shock** button begins flashing. The unit also emits a charge-ready tone, and directs the rescuer to press the **Shock** button to deliver therapy. In semiautomatic mode, the rescuer must deliver the shock within 30 seconds of full charge, otherwise the defibrillator automatically disarms itself, and the unit resumes ECG analysis.

After delivering a shock, the unit continues analyzing the patient’s ECG, guiding the rescuer to perform CPR or to deliver additional shocks, if needed.

The unit also provides CPR monitoring if ZOLL CPR-D-padz® or CPR Stat-padz® defibrillation electrodes are attached. CPR-D-padz and CPR Stat-padz include a sensor to monitor the rescuer’s chest compression rate and depth. The compression data enables the unit to guide the rescuer to perform effective CPR. The unit can be preconfigured to prompt the rescuer to perform a period of CPR before the first ECG analysis cycle begins.

For more information, refer to Chapter 3, “Semiautomatic Mode”.

# Chapter 1

## Product Overview

---

The AED Pro device provides the following clinical modes:

- Semiautomatic defibrillation with CPR monitoring
- Manual defibrillation
- ECG monitoring

To guide the operator through rescue protocols, the AED Pro unit issues instructions through text messages displayed on its screen and by voice prompts played through a speaker.

This chapter introduces the AED Pro unit, and contains the following sections:

- “Defibrillation” on page 1-2
- “Semiautomatic Mode Defibrillation and CPR Monitoring” on page 1-2
- “Manual Mode Defibrillation” on page 1-3
- “ECG Monitoring” on page 1-3
- “Audio Recording” on page 1-4
- “Nonrescue Mode” on page 1-5
- “Standby State” on page 1-5
- “Automatic Shutoff” on page 1-5
- “Accessories” on page 1-6
- “The Front Panel” on page 1-8

## Defibrillation

The AED Pro unit uses the ZOLL Rectilinear Biphasic™ waveform and ZOLL single-use defibrillation electrode pads for defibrillation.

Escalating energy levels for the first three shocks are preconfigured into the unit for adult and pediatric patients. (The unit selects the appropriate levels by detecting the type of defibrillation electrode pads in use.) After the first three shocks, all subsequent shocks are delivered at the same energy as the third shock.

The factory default energy levels in joules are as follows:

	First shock	Second shock	Third shock
Adult	120	150	200
Pediatric	50	70	85

These energies will be delivered by the AED Pro into a 50Ω patient load.

For more information, refer to Appendix C, “Configurable Settings”.

## Defibrillation Modes

The AED Pro unit can be manufactured to run in one of three defibrillation modes:

- Semiautomatic Mode Defibrillation with CPR Monitoring
- Manual Mode Defibrillation
- Semiautomatic Mode Defibrillation with CPR Monitoring and Manual Mode Override

## Semiautomatic Mode Defibrillation and CPR Monitoring

When the AED Pro unit is configured to run in semiautomatic mode or semiautomatic mode with manual mode override, the unit starts up in semiautomatic mode unless an AED Pro ECG cable is attached to the unit.

In semiautomatic mode, the unit analyzes the patient’s ECG through the defibrillation electrode pads attached to the patient. If the unit detects a shockable rhythm, it automatically charges to the appropriate (preconfigured) energy level. Once the defibrillator is fully charged, the **Shock** button begins flashing. The unit also emits a charge-ready tone, and directs the rescuer to press the **Shock** button to deliver therapy. In semiautomatic mode, the rescuer must deliver the shock within 30 seconds of full charge, otherwise the defibrillator automatically disarms itself, and the unit resumes ECG analysis.

After delivering a shock, the unit continues analyzing the patient’s ECG, guiding the rescuer to perform CPR or to deliver additional shocks, if needed.

The unit also provides CPR monitoring if ZOLL CPR-D-padz® or CPR Stat-padz® defibrillation electrodes are attached. CPR-D-padz and CPR Stat-padz include a sensor to monitor the rescuer’s chest compression rate and depth. The compression data enables the unit to guide the rescuer to perform effective CPR. The unit can be preconfigured to prompt the rescuer to perform a period of CPR before the first ECG analysis cycle begins.

For more information, refer to Chapter 3, “Semiautomatic Mode”.



## Manual Mode Defibrillation

In manual mode, the rescuer controls each step of defibrillation therapy. The AED Pro unit displays patient ECG data and heart rate on the screen. The rescuer uses this information to determine whether or not the patient has a shockable rhythm.

If the AED Pro unit is configured for semiautomatic mode defibrillation with ECG monitoring enabled and manual mode override, and the ECG cable is not attached, the AED Pro unit starts in semiautomatic mode at power up. If the AED Pro unit is configured for manual mode defibrillation, the AED Pro unit runs only in manual mode.

When a shock is deemed necessary, the rescuer charges the defibrillator by pressing the **CHARGE** softkey to charge the unit to the preconfigured energy level.

**Note:** Defibrillation energy levels are preconfigured and cannot be changed during clinical use.

Once the defibrillator is fully charged, the **Shock** button begins flashing. The unit also emits a charge-ready tone, continuously for the first 50 seconds, and then intermittently for the final 10 seconds. The rescuer must deliver the shock within this 60-second period, otherwise the defibrillator automatically disarms itself. To recharge the unit, the rescuer must press the **CHARGE** softkey again.

For more information, refer to Chapter 4, “Manual Mode”.

## ECG Monitoring

The optional ECG monitoring mode provides ECG rhythm and heart rate display, as well as performing background ECG analysis to detect shockable rhythms. If the AED Pro unit detects a shockable rhythm during monitoring, it immediately alerts the rescuer through displayed and voiced prompts; if defibrillation pads are attached, the unit automatically switches to semiautomatic mode.

For ECG monitoring, you can use

- AED Pro-compatible defibrillation electrode pads
- Standard ECG electrodes (with an AED Pro ECG cable)

While ECG electrodes (not defibrillation electrode pads) are connected to the unit, the only available mode is ECG monitoring.

All ECG monitoring is performed in the lead II configuration. The operator cannot select another lead.

For more information, refer to Chapter 5, “ECG Monitoring Mode”.

## Audio Recording

When installed and enabled, the Audio Recording Option allows the AED Pro unit to record up to 20 minutes of continuous audio and clinical event data during a rescue. (The AED Pro unit can record and store at least 5.8 hours of clinical event data when the Audio Recording Option is disabled.) The recorded audio data is synchronized to the clinical event data.

**Note:** The AED Pro unit records up to 3 minutes of audio data prior to electrode placement.

The AED Pro unit can record and store data for only a *single* rescue when audio recording is enabled — when the electrode pads are placed on the patient, the unit deletes any stored data (ECG, Audio, and Event data) and begins recording data from the current rescue.

When you start the AED Pro unit in Non-rescue Mode, it does not delete stored rescue data.

## Nonrescue Mode

The AED Pro unit provides the following functions in nonrescue mode:

- Data transfer
- Device configuration

The following sections briefly describe these functions. For more information, refer to Chapter 6, “Nonrescue Mode”.

### Data Transfer

The AED Pro unit includes nonvolatile memory, which automatically records

- Device history
- Clinical data

Stored information can be transferred to a remote device (such as a computer) through a USB device or an IrDA (infrared wireless) connection. The clinical data format is compatible with ZOLL RescueNet<sup>®</sup> Code Review software, which can be used to review and analyze the patient data.

The unit retains the device history and clinical data even when powered off or when the battery pack is removed. Clinical data is erased only when the device is powered on and electrodes are attached to a new patient. If configured to do so, the unit can store data for more than one patient.

### Device Configuration

The AED Pro unit provides configurable settings that can be used to tailor the device for local rescue protocols and procedures. Using the ZOLL Administration Software on a personal computer, you can view or modify the unit’s configuration.

### Standby State

When the unit is turned off with a good battery installed, the unit enters standby state. While in standby, the unit periodically starts up automatically to perform a self-test, and then returns to standby. The Ready indicator shows the result of the self-test. The frequency of self-tests while the unit is in standby state is a configurable setting.

### Automatic Shutoff

The unit automatically powers off if no patient connection is detected within 10 minutes (configurable).

## Accessories

The following related accessories and equipment are available.

Item	REF
Adult CPR-D-padz electrodes	8900-0800-01
Adult CPR Stat-padz electrodes	8900-0400
Adult Stat-padz II electrodes	8900-0801-01
Pediatric Pedi-padz II electrodes	8900-0810-01
ECG electrodes: 3 ECG electrodes/pouch (200 pouches / 600 electrodes)	8900-0003
AED Pro ECG cable	AAMI 8000-0838 IEC 8000-0839
Defibrillation analyzer (universal) adapter cable	8000-0804-01
Rechargeable PD 4410 battery pack	Standard 8004-0009 Smart 8004-0103-01 Smart Ready 8004-0104-01
Disposable sealed lithium manganese dioxide battery pack	8000-0860-01
AED Pro carry bags	Soft carry case 8000-0810-01 Molded vinyl case with spare battery compartment 8000-0832-01 Hard case with foam cut-outs 8000-0875-32
IrDA adapter for personal computer	USB 8000-0815 RS-232 8000-0816
AED Pro simulator	8000-0829-01
See-Thru CPR <sup>®</sup> simulator	8009-0751-01
AED Pro ZOLL Administration Software (ZAS) CD	9658-0800-01
RescueNet Code <sup>®</sup> Review Standard software for Windows: installation CD and Getting Started Guide	8000-0608-01
AED Pro Service Manual	9650-0309-01
AED Pro Simulator Manual	9651-0801-01
SurePower Charger Station	8050-0030-01
SurePower Battery Pack	8019-0535-01

---

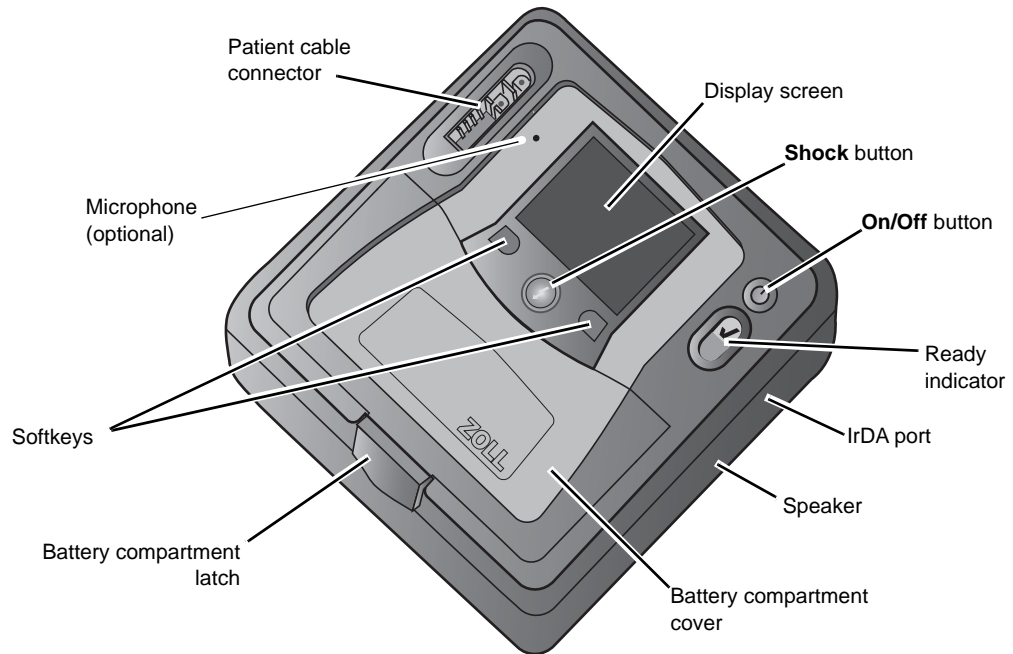
## A-W Accessories

The following accessories are also available for the AED Pro A-W.

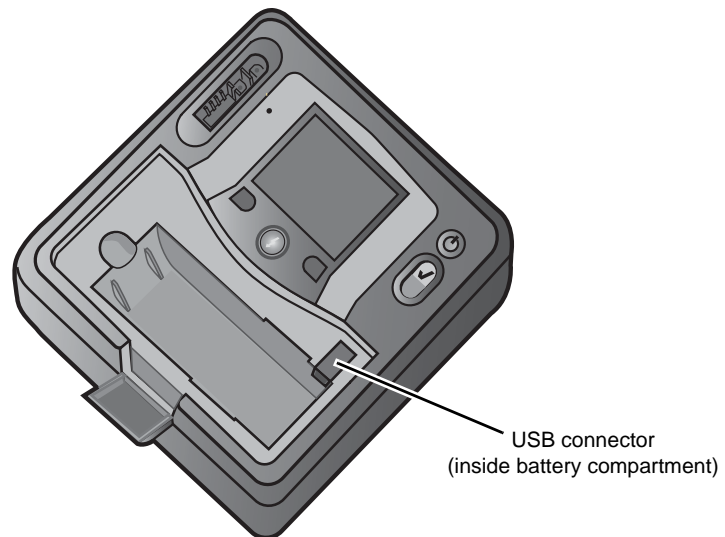
<b>Item</b>	<b>REF</b>
CPR-D-padz one piece defibrillation and CPR System Adult Electrode <b>(Airworthy Certified)</b>	8900-0800-01
Airworthy Stat-padz II Adult Multi-Function Electrodes w/ Ferrite (1 pair) <b>(Airworthy Certified)</b>	8900-0840-30
Airworthy Stat-padz II Adult Multi-Function Electrodes w/ Ferrite (Case of 12) <b>(Airworthy Certified)</b>	8900-0841-30
AED Pro ECG Cable AAMI <b>(Airworthy Certified)</b>	8000-0838
AED Pro A-W non-rechargeable lithium battery pack <b>(Airworthy Certified)</b>	8000-0860-30

## The Front Panel

Figure 1-1 shows the front panel of the AED Pro unit. Table 1-1 describes each of the unit's front panel features.






**Figure 1-1. AED Pro Front Panel**



**Figure 1-2. USB Connector**

Table 1-1. AED Pro Front Panel Features

Feature	Description
Shock button	When the defibrillator is fully charged and ready, the <b>Shock</b> button repeatedly flashes. To deliver a shock, press and hold the button.
On/Off button	To start the unit, press this button and release it within 5 seconds. To start the unit in nonrescue mode, press and hold this button for more than 5 seconds. To turn the unit off and place it in standby state, press and hold this button for 1 second.
Ready indicator	 <p>Shows the status of the unit, based on its last self-test.</p> <p>A green check indicates the unit is ready for use.</p> <p>A red “X” indicates the unit is not ready for use.</p>
IrDA port	Provides a way to connect the unit to an external device for transferring patient data, unit status information, or configuration information.
Speaker	Issues voice prompts and alerts.
Battery compartment	Holds the battery pack.
Battery compartment latch	Provides access to the battery compartment.
Softkeys	Directly below the display, two unlabeled buttons control various functions depending on the operating mode. Labels for the softkeys appear at the bottom of the display above each softkey to indicate its function.
Patient cable connector	Used for plugging in defibrillation electrodes or an AED Pro ECG cable.  This connector is a defibrillator-proof type BF patient connection using defibrillation electrodes.  This connector is a defibrillator-proof type CF patient connection using the AED Pro ECG cable.
USB connector	Allows you to download patient data to a USB device.
Microphone (optional)	Allows the AED Pro Unit to record audio rescue data. Only AED Pro units that have been ordered with the Audio Recording Option have a microphone installed.

## Display Screen

The display screen shows the following items (depending on the activity in progress):

**Elapsed time** — Shows the total time (in hours, minutes, and seconds) since the unit was turned on. The counter resets to 00:00:00 after 23 hours, 59 minutes, and 59 seconds, or when the unit is turned off.

**ECG size** — Shows the amplitude scale for the displayed ECG in centimeters per millivolt (cm/mV). The device adjusts the scale automatically. The ECG scale marker always indicates the size of a 1 mV peak-to-peak signal.

**Heart rate and heartbeat symbol** — (Manual and ECG monitoring modes only) Shows the current heart rate in beats per minute. The symbol flashes with each detected heartbeat.

**Chest compression depth gauge**— Shows the depth of chest compression during CPR when ZOLL CPR-D-pads are connected. The bar extends downward as the depth of compression increases, with scale marks representing 0, 2.0 inches, and 2.4 inches.

**Softkey labels** — Labels for the softkeys appear at the bottom of the display directly above each softkey to indicate its function.

**Text prompts and messages** — In semiautomatic mode, text prompts guide the rescuer. In all modes, messages alert the operator about problem conditions.

**ECG rhythm** — Displays the patient's ECG.

**Shock symbol and number of shocks delivered** — Shows the number of shocks delivered since the unit was powered on.

**Current mode** — Displays MANUAL in manual mode, or MONITOR in ECG monitoring mode. No mode label appears in semiautomatic mode.



Figure 1-3 shows the layout of the screen and the location of the above items.

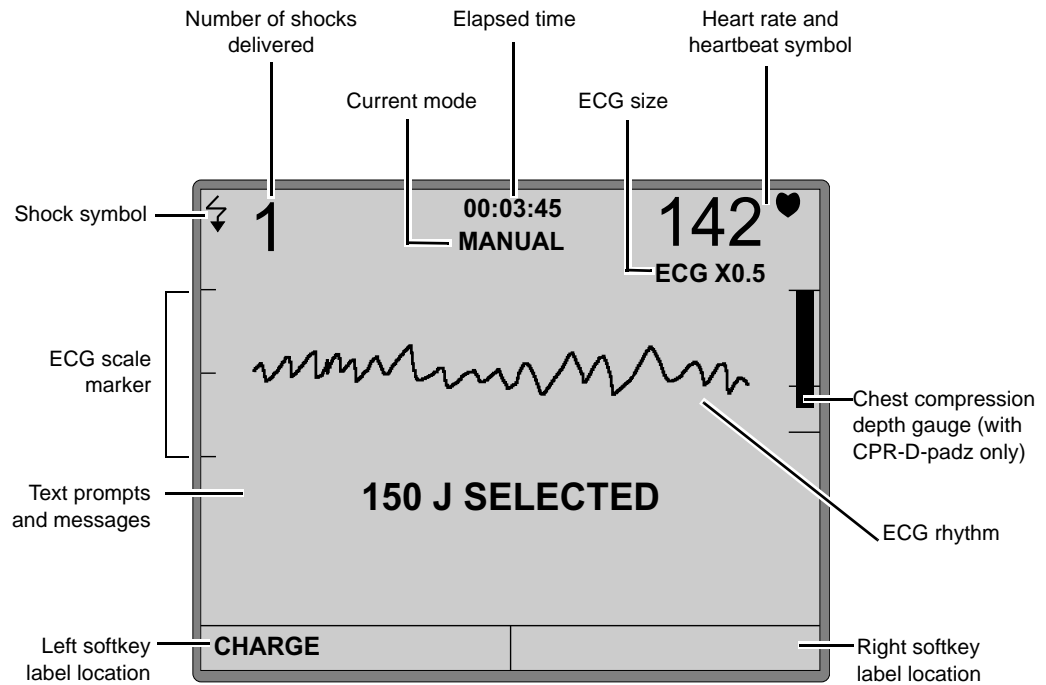


Figure 1-3. AED Pro Display Screen Elements

(This page intentionally left blank.)

# Chapter 2

## Getting Started

---

This chapter describes some common tasks that you must do to get the AED Pro unit ready to use, and contains the following sections:

- “Installing a Battery Pack” on page 2-2
- “Preparing the Unit for Clinical Use” on page 2-5
- “Performing a Self-Test” on page 2-6
- “Preconnecting the Defibrillation Electrodes Cable” on page 2-7
- “Messages” on page 2-8

## Installing a Battery Pack

The AED Pro unit accepts the following types of battery packs:

- Rechargeable PD 4410-series battery packs
- Disposable sealed lithium manganese dioxide battery packs
- SurePower rechargeable lithium ion battery packs

When the unit displays the message *CHANGE BATTERY*, immediately replace the battery with a fully charged battery pack.

### Before you begin

Be sure the unit is turned off.

Be sure the battery pack to be installed is fully charged.

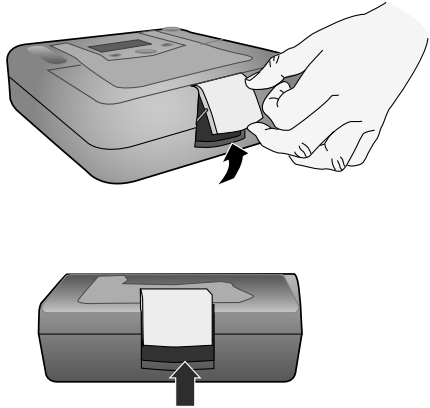
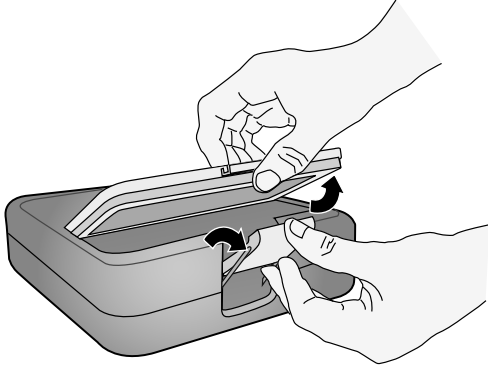
---

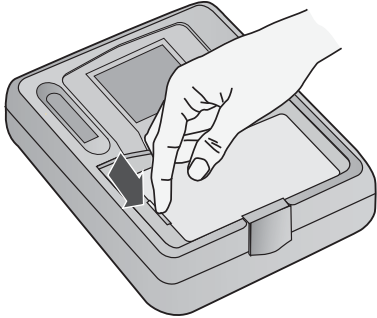
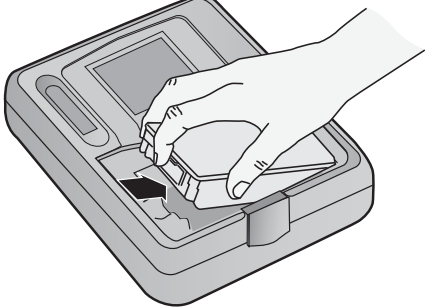
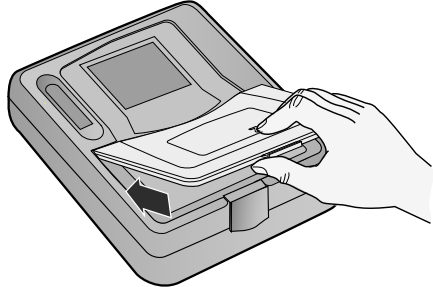

**WARNING!** Do not use a rechargeable battery pack if the unit's standby period will exceed 90 days.

---

### Procedure

To install or replace a battery pack:

Step	Action	Notes
1	Pull the bottom edge of the battery compartment latch outward.  When released, the latch slides upward.	
2	Pull the top edge of the latch toward you and then downward.	
3	Lift the edge of the battery compartment cover.	

Step	Action	Notes
4	Slide out the cover panel.	
5	If a battery is installed, remove it from the compartment by pressing the tab on the battery pack.	
6	Align the tab of the new battery with the finger access area on the left side of the battery compartment, then place the battery into the compartment.	<p>The shape of the battery pack allows it to seat itself properly.</p> 
7	Press the edge of the battery pack until it clicks into place.	
8	Slide the cover panel back into place, and then lower the edge of the cover.	
9	Raise the compartment latch, and tilt the top edge toward the unit.	
10	Press the bottom edge of the latch toward the unit to lock the cover in place.	

**Important:** If you change the battery while the unit is in clinical use (that is, with a cable connected), the unit automatically powers on in nonrescue mode and then shuts down. Press and release the **On/Off** button to restart the unit.

## CHANGE BATTERY Warning

When the unit detects a low energy condition, it issues the voice and text prompt *CHANGE BATTERY* once every minute. Depending on the age and condition of the battery, the remaining operating time of the unit might be extremely limited.

The warning message continues until the device shuts down.

---

**WARNING!** To ensure the availability of adequate power during an emergency, keep a fully charged spare battery pack with the device at all times.

---

Whenever the unit issues the prompt *CHANGE BATTERY*, immediately replace the used battery pack with a fully charged one to ensure continuous operation and to avoid unexpected device shutdown. After removing a depleted rechargeable battery pack from the unit, recharge the pack as soon as possible.

Battery Condition	Indications	Correction
Low energy detected during power-on self-test.	Message: <i>CHANGE BATTERY</i>	Replace battery pack.
Low energy or other self-test failure while the unit is powered off (standby).	Ready indicator shows a red "X". Unit beeps once every minute for 30 minutes.	Replace battery pack. Check or replace preconnected electrodes. If the red "X" remains, contact ZOLL Technical Service.
Low energy detected while the unit is powered on.	Message: <i>CHANGE BATTERY</i>	Replace battery pack as soon as possible.
Dead battery	Ready indicator shows a red "X".	Replace battery pack. If the red "X" remains, contact ZOLL Technical Service.

## Preparing the Unit for Clinical Use

The following setup and checkout procedures should be performed before placing the unit into service and after each clinical use.

### Before you begin

You need the following items:

- A fully charged battery
- Defibrillation electrode pads

### Procedure

To prepare an AED Pro unit for clinical use:

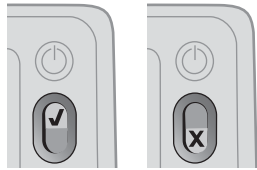
Step	Action
1	Inspect all external surfaces of the unit to ensure that they are clean (with no fluid spills) and free from structural damage, such as cracks and broken or missing parts.
2	Inspect the patient cable connector to ensure that the pins are not broken, bent, or missing.
3	Inspect all cables. Replace any item that is cut or frayed, or that has bent pins.
4	Install a fully charged battery pack that is appropriate for your application.
5	Ensure that you have an adequate supply of defibrillation and ECG electrodes.
6	Verify that the defibrillation electrodes have not expired and are not close to expiration.
7	Follow the instructions provided with the defibrillation electrodes to preconnect them to the patient cable connector. <b>Note:</b> If electrodes are not preconnected, the unit will fail its next self-test in standby state.
8	Press and release the <b>On/Off</b> button to turn on the unit and initiate a power-on self-test. The message <i>UNIT OK</i> indicates that the battery pack and electrodes are properly installed and that the unit is ready for service. The message <i>UNIT FAILED</i> indicates that the unit is not ready for service.
9	Verify that the unit correctly detects the type of electrodes that are attached (with the message <i>ADULT PADS</i> or <i>PEDIATRIC PADS</i> ).
10	Press and hold the <b>On/Off</b> button for 1 second to turn off the unit.
11	Wait 2 minutes. Verify that the Ready indicator displays a green check, and that the unit does not beep.
12	Place the unit into service.

While the unit is in service, periodically check the Ready indicator to ensure that it displays a green check and inspect the unit for physical damage.

## Performing a Self-Test

The AED Pro unit performs automatic or manual self-tests to verify its integrity and readiness for emergency use. These tests verify the following:

- Battery energy — Verifies that the battery energy is sufficient for at least 2 hours of continuous monitoring and ten shocks at maximum energy.
- Defibrillation electrodes connection — Verifies that defibrillation electrodes are properly preconnected to the unit.
- ECG circuitry — Verifies that the ECG signal acquisition and processing electronics are functional.
- Defibrillator charge and discharge circuitry — Verifies that the defibrillator electronics are functional and can charge and discharge at 2 joules.
- Microprocessor hardware and software — Verifies the proper function of the microprocessor electronics and the integrity of the software.
- CPR circuitry and sensor — Verifies that the CPR monitoring and compression depth detection are functional (when CPR-D-padz or CPR Stat-padz are attached).
- Audio circuitry — Verifies that the audio output circuitry is functional.
- Display — Verifies that the visual indicators are functional.



After the successful completion of the self-test, the Ready indicator displays a green check, indicating that the unit is ready for use.

If the Ready indicator displays a red “X” after a self-test, the unit is not ready for use and might be defective. Remove the unit from service and consult the Troubleshooting chapter of this guide.

## Automatic Self-Tests

The unit performs a self-test whenever it is turned on or a battery pack is installed, or at periodic intervals while in standby state. The interval for automatic self-tests in standby state is a configurable setting; the default interval is one day. For more information, refer to Appendix C, “Configurable Settings”.

## Manual Self-Test

You can manually initiate a self-test by pressing and holding the **On/Off** button for 5 seconds. The unit illuminates the **Shock** button and issues voice and text messages so that you can verify the visual and auditory output functions. In addition, the screen shows information about the unit’s hardware and software.



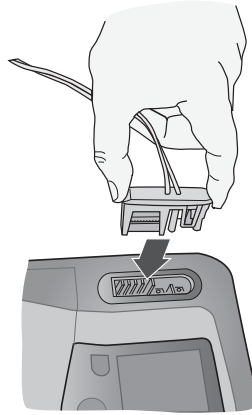


## Preconnecting the Defibrillation Electrodes Cable

---

**WARNING!** To prepare for an emergency, keep the defibrillation electrodes cable connected to the unit at all times.

---



---

**WARNING!** Do not reuse defibrillation electrodes.

---

The AED Pro unit supports both adult and pediatric electrode pads. The device adjusts defibrillation energy to adult or pediatric levels depending on the type of electrodes connected to it. Always use electrode pads that are appropriate for the patient.

---

**WARNING!** Do not use adult defibrillation electrode pads or CPR-D-padz on patients under 8 years of age.

---

The electrode packaging allows you to connect the cable to the unit while the pads remain in a sealed envelope.

- To prepare for future emergencies, after each use connect a new package of electrodes by plugging the electrode cable into patient cable connector.
- To ensure that the electrodes are fresh and ready to use in an emergency, regularly check the electrode expiration date on the preconnected electrode pack.
- Replace expired electrodes.
- After completing its power-on self-test, the unit issues a voice and text message to indicate the type of electrodes that are connected (*ADULT PADS* or *PEDIATRIC PADS*). Verify that the connected electrodes are appropriate for the patient. If necessary, replace the connected electrodes with appropriate ones.

If the electrode cable is not properly connected to the unit, the unit issues the voice and text prompt *PLUG IN CABLE*.

If the electrodes are not properly attached to the patient, the unit issues the voice and text prompt *CHECK DEFIB PADS* or *ATTACH DEFIB PADS TO PATIENT'S BARE CHEST*.

## Messages

While preparing the AED Pro unit for use, the following messages can be seen and/or heard:

<b>Message</b>	<b>Description</b>
<i>UNIT OK</i>	The unit successfully passed its power-on self-test.
<i>UNIT FAILED</i>	The unit failed its power-on self-test and is not usable for patient care.
<i>CHANGE BATTERY</i>	The self-test detected a low energy condition that is insufficient for patient care. Replace the battery pack immediately.
<i>ADULT PADS</i> <i>PEDIATRIC PADS</i>	The unit detected the specified type of electrode pads and adjusted defibrillation energy settings accordingly.
<i>PLUG IN CABLE</i>	The unit started up without an electrode cable plugged in. Plug the cable into the unit.
<i>NON-RESCUE MODE</i>	The device is operating in nonrescue mode and an IrDA connection is established.
<i>POWERING OFF</i>	The <b>On/Off</b> button was pressed and held for 1 second to turn the unit off.

# Chapter 3

## Semiautomatic Mode

---

In semiautomatic mode, the unit uses voice prompts and visual indicators to guide the rescuer through a resuscitation sequence that can include defibrillation and/or cardiopulmonary resuscitation (CPR).

AED models start up in semiautomatic mode unless an AED Pro ECG cable is connected to the unit. For more information, refer to Chapter 5, “ECG Monitoring Mode”.

After guiding the rescuer through patient assessment by issuing voice and text messages, the unit issues the voice and text prompt *DON'T TOUCH PATIENT, ANALYZING*. The unit then begins analysis of the patient's ECG to determine whether the rhythm is shockable or not and announces and displays the result (*SHOCK ADVISED* or *NO SHOCK ADVISED*).

If defibrillation is needed, ECG analysis ends and the unit charges to the preconfigured energy level. When charged, the unit emits a charge-ready tone, repeatedly flashes the **Shock** button, and issues the voice and text prompt *PRESS FLASHING SHOCK BUTTON*. After the rescuer presses the button to deliver therapy, the unit resumes analysis and can guide the rescuer through an escalating series of three shocks if necessary.

This chapter contains the following sections:

- “Applying Defibrillation Electrode Pads” on page 3-2
- “Semiautomatic Defibrillation” on page 3-9
- “Messages in Semiautomatic Mode” on page 3-12

## Applying Defibrillation Electrode Pads

To deliver defibrillation therapy to a patient, you must use AED Pro-compatible defibrillation electrode pads:

- ZOLLCPR-D-padz (adult patients; includes CPR sensor)
- CPR Stat-padz (adult patients; includes CPR sensor)
- ZOLL Stat-padz II (adult patients)
- ZOLL Pedi-padz II (pediatric patients)

Defibrillation electrode pads connect to the AED Pro unit through the patient cable connector. Preconnect a set of electrode pads so that they are ready for use in an emergency.

---

**WARNING! Do not open the sealed electrodes until immediately prior to use.**

---

You can also use defibrillation electrode pads for ECG monitoring.

Before applying defibrillation electrode pads to the patient, be sure to

- Remove all clothing covering the patient's chest.
- Clip or shave any excessive hair to ensure proper adhesion of the pads.
- Use alcohol to wash away any oil or dirt at the electrode site.
- Dry any moisture at the electrode site.

---

**WARNING! Poor adherence or air pockets under the defibrillation electrode pads can lead to arcing, skin burns, or reduced energy delivery.**

---

For proper placement of electrodes for defibrillation, refer to the graphics on the electrode packaging.

Check the expiration date on the defibrillation electrode packaging. Do not use expired pads.



This symbol on the electrode label is accompanied by the expiration date.

**Note:** ZOLL electrodes contain no hazardous materials and may be disposed of in general trash unless contaminated with pathogens. Use appropriate precautions when disposing of contaminated electrodes.

---

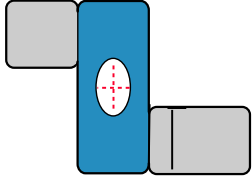
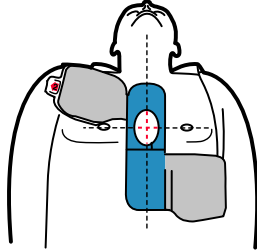
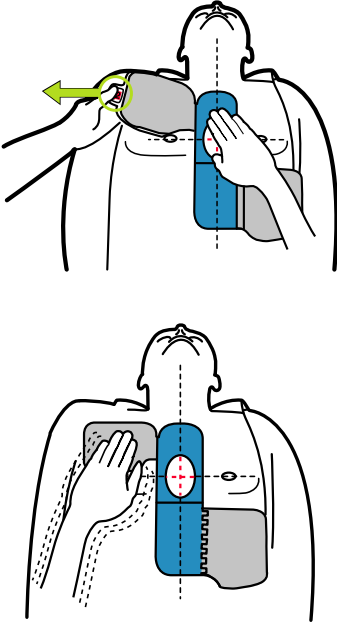
**WARNING! The use of accessories and cables other than those specified in the accessories section of this document may result in increased emissions or decreased immunity of the AED Pro defibrillator.**

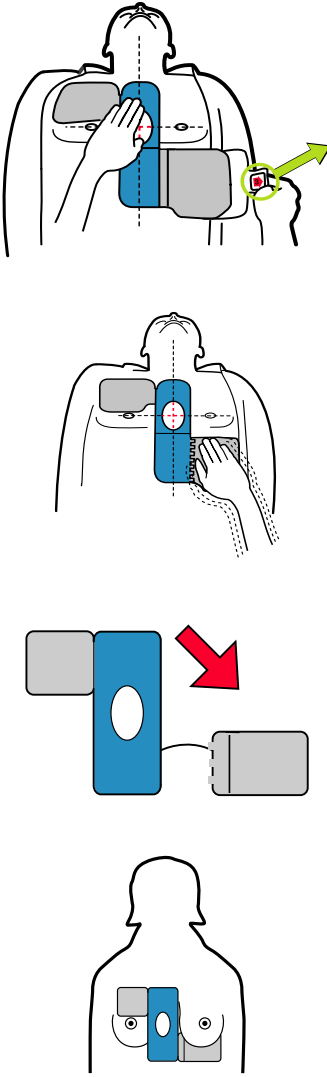
---

Applying Defibrillation Electrode Pads — Adult CPR-D-padz

**WARNING!** ZOLL CPR-D-padz are for adult patients only; do not use them on patients under 8 years of age.

To apply CPR-D-padz defibrillation electrodes:

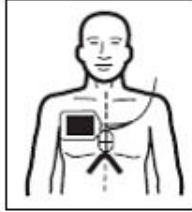
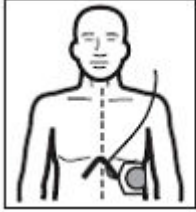
Step	Action	
1	Tear open the electrode package and unfold the electrodes.	
2	Using the cross hairs on the CPR sensor to guide you, place the sensor on the middle of the patient's breastbone, between the nipples.	
3	<p>Hold the CPR sensor in place with your right hand, and use your left hand to pull the number 2 tab and peel the protective backing from the electrode.</p> <p><b>Note:</b> If the patient has an implanted pacemaker or defibrillator in his/her upper right chest, angle the electrode slightly to avoid placing it over the device. Ensure that the CPR sensor remains over the lower half of the breastbone.</p> <p>Press the electrode from the center of the chest outward to push out air from beneath the pad, and to make sure the pad adheres properly to the patient's skin.</p>	

Step	Action	
<p><b>4</b></p>	<p>Hold the CPR sensor in place with your left hand, and use your right hand to pull the number 3 tab and peel the protective backing from the electrode.</p> <p>Press the electrode from the center of the abdomen outward to push out air from beneath the pad, and to make sure the pad adheres properly to the patient's skin.</p> <p>If the patient is large or there is a need to place the electrode under a breast, there is a need to place the electrode under a breast, you can detach the lower pad at the perforation and extend it for effective positioning.</p> <p>Place the pad slightly to the patient's left and below the patient's left breast.</p>	

## Applying Defibrillation Electrode Pads — Adult CPR Stat-padz

**WARNING!** ZOLL CPR Stat-padz are for adult patients only; do not use them on patients under 8 years of age.

To apply CPR Stat-padz defibrillation electrodes:

Step	Action	
1	Tear open the electrode package and expose the electrodes. Grasp the square electrode at the bottom (with the attached sensor) and peel from the plastic liner.	
2	Place the CPR sensor on the sternum, lining up the cross hairs with the patient's nipple line and center of the sternum. Place the electrode in the mid clavicular line below the patient's right clavicle as shown in the diagram. Avoid any contact between the nipple and gel treatment area.	
3	Gently roll the electrode onto the chest, pushing any air out from beneath the electrode. <b>Note:</b> If the patient has an implanted pacemaker or defibrillator in his/her upper right chest, angle the electrode slightly to avoid placing it over the device. Ensure that the CPR sensor remains over the lower half of the breastbone.	
4	Grasp the round electrode at the bottom and peel it from the plastic liner. Apply the electrode so it lines up with the bottom of the pectoral muscle on a male patient, as shown in the diagram. For female patients, place the electrode under the breast. <b>Note:</b> A more lateral placement increases the likelihood that more of the heart musculature will be within the current.	

## CPR Monitoring with CPR-D-padz and CPR Stat-padz

ZOLL CPR-D-padz and CPR Stat-padz electrodes include a sensor that detects the rate and depth of chest compressions. When the electrodes are properly positioned on the patient, the sensor lies between the rescuer's hands and the patient's lower sternum. While the rescuer performs chest compressions, the sensor detects the rate and depth and sends the information to the AED Pro unit.

If the unit does not detect chest compressions during a CPR period, it periodically issues the voice and text prompt *CONTINUE CPR* (if configured to do so).

ZOLL CPR-D-padz and CPR Stat-padz electrodes can be connected to other ZOLL defibrillators, and defibrillation can be administered through other ZOLL defibrillators. The CPR function, however, does not operate with any device other than the ZOLL AED Pro or the ZOLL AED Plus<sup>®</sup>.

### Chest compression rate

With CPR-D-padz and CPR Stat-padz, the unit provides a metronome function to encourage rescuers to perform chest compressions at the AHA/ERC recommended rate of 100 compressions per minute.

When CPR is indicated, the metronome begins to beep after detecting the first few chest compressions. The metronome continues (at rates described below) until a few seconds after the rescuer halts compressions or until the recommended CPR period ends (2 minutes for AHA and ERC protocols).

The metronome beeps 100 times per minute to encourage the rescuer to increase the rate of chest compressions to achieve the recommended rate of 100 cpm.

During the CPR period, if the rescuer stops chest compressions, the metronome stops within a few seconds. If chest compressions resume, the metronome starts again.

The metronome is disabled whenever CPR should not be performed (for example, during ECG analyses and defibrillation shock sequences).

### Chest compression depth

With CPR-D-padz and CPR Stat-padz, the unit provides visual indicators and voice prompts to encourage a chest compression depth of at least 2 inches (5 cm) for adult patients.

The screen displays a gauge, which shows the depth of chest compressions. Compression depth is correct when the bar extends downward between the lower two lines, which represent 2.0 and 2.4 inches (5 to 6 cm).

When the detected compression depth is consistently less than 2 inches (5 cm), the unit issues the voice and text prompt *PUSH HARDER*. If the rescuer responds by increasing compression depth to 2 inches (5 cm) or more, the unit issues the voice and text message *GOOD COMPRESSIONS*.

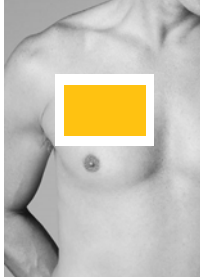
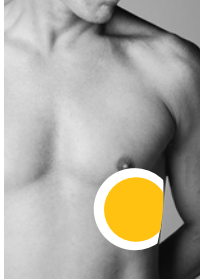

The AED Pro unit can be configured to display the *FULLY RELEASE* text prompt to remind the rescuer to lift the hands off the chest during CPR. By default, this text prompt is not enabled.



## Applying Defibrillation Electrode Pads — Adult Stat-padz II

**WARNING!** ZOLL Stat-padz II electrodes are for adult patients only; do not use them on patients under 8 years of age.

To apply Stat-padz II defibrillation electrode pads:

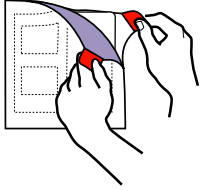
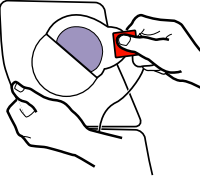
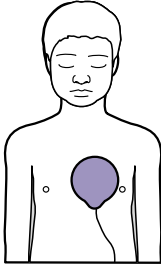
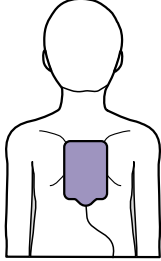
Step	Action	
1	Tear open the electrode package and unfold the inner package to expose the electrodes.	
2	Remove the square electrode from its backing material, and place it on the patient's upper right chest as shown.	
3	Place your hand on the electrode edge. Using your other hand, gently roll the electrode onto the patient's chest, pushing out air from beneath the electrode as you go.	
4	Remove the round electrode from its backing material, and place it on the patient's lower left chest as shown.	 <p>For female patients, place the electrode under the patient's left breast.</p> 
5	Place your hand on the electrode's edge. Using your other hand, roll the electrode onto the patient's skin, pushing out air from beneath the electrode as you go.	
6	Follow the AED Pro prompts.	

## Applying Defibrillation Electrode Pads — Infant/Child Pedi-padz II

**WARNING!** ZOLL Pedi-padz II electrodes are for pediatric patients only; these pads provide defibrillation energy levels that might be inadequate for adult patients.

### Procedure

To apply Pedi-padz II defibrillation electrode pads:

Step	Action	
1	Tear open the electrode package and unfold the inner package to expose the electrodes.	
2	Remove the round electrode from its backing material.	
3	Position the electrode on the patient's chest as shown. Place your hand on the electrode edge. Using your other hand, gently roll the electrode onto the patient's chest, pushing out air from beneath the electrode as you go.	
4	Roll the patient onto his/her chest.	
5	Remove the square electrode from its backing material.	
6	Position the electrode on the patient's back as shown. Place your hand on the electrode's edge. Using your other hand, roll the electrode onto the patient's skin, pushing out air from beneath the electrode as you go.	
7	Roll the patient onto his/her back, and follow the AED Pro prompts.	

## Semiautomatic Defibrillation

In semiautomatic mode, the AED Pro unit analyzes the patient's ECG rhythm to determine whether it is shockable or not. If a shock is needed, follow the text and voice prompts to defibrillate the patient.

---

**WARNING!** During ECG analysis, do not touch or move the patient. If conveying the patient in a vehicle or stretcher, cease all patient movement.

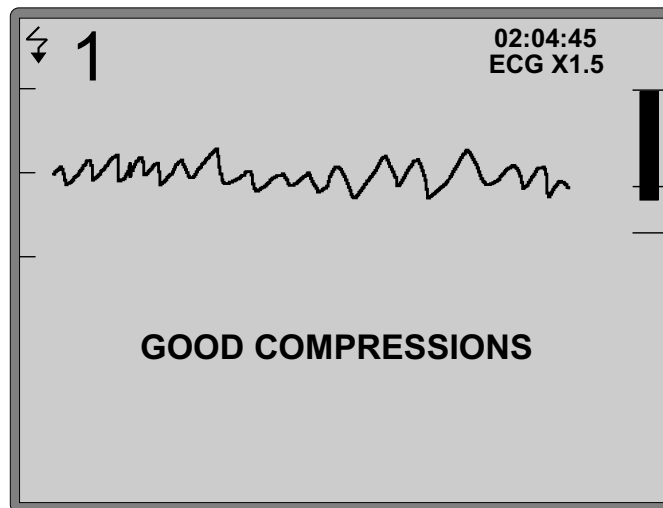
---

After an ECG analysis resulting in delivery of a shock, or after any no-shock-advised result, the unit initiates a period of CPR.

**Note:** If the AED Pro unit is configured to use a two or three shock sequence, the unit initiates a period of CPR after two episodes of ECG analysis and shock (two shock sequence) or three successive episodes of ECG analysis and shock (three shock sequence), or after a no-shock-advised result.

In semiautomatic mode, the screen shows the shock count, elapsed time, ECG size, ECG rhythm, and text messages.

If CPR-D-padz or CPR Stat-padz are attached to the patient, the screen includes a chest compression gauge that shows the depth of each chest compression as detected by the CPR sensor.



The rhythm recognition detector continues analyzing the ECG after detecting a shockable rhythm and the defibrillator is charged and ready but will not bring the unit into a state where defibrillation is prohibited.

**Before you begin**

Be sure the defibrillation cable is plugged into the unit.

**Procedure**

To defibrillate the patient in semiautomatic mode:

Step	Action	Result
1	Press and release the <b>On/Off</b> button to turn on the unit.	On successful completion of the power-on self-test, the unit indicates the type of attached electrodes. If the defibrillation pads are not attached to the patient, the unit issues the voice and text prompt:  <i>ATTACH DEFIB PADS TO PATIENT'S BARE CHEST</i>
2	If prompted, apply defibrillation electrode pads to the patient.  (Refer to "Applying Defibrillation Electrode Pads" on page 3-2.)	When the pads are properly attached to the patient, the unit issues the voice and text message:  <i>DON'T TOUCH PATIENT, ANALYZING</i> and then begins ECG analysis.
3	Allow the unit to analyze the patient's ECG.	The unit determines whether or not the patient has a shockable rhythm and then displays and voices its recommendation:  <i>SHOCK ADVISED</i>  or  <i>NO SHOCK ADVISED</i>
4	After ECG analysis, which message appears?  — If <i>SHOCK ADVISED</i> , continue with step 5.  — If <i>NO SHOCK ADVISED</i> , go to step 8.	If a shock is needed, the defibrillator automatically begins charging.  If a shock is not needed, the unit prompts you to perform CPR.
5	Wait for the defibrillator to charge.	When fully charged, the unit emits a charge-ready tone, repeatedly flashes the <b>Shock</b> button, and issues the voice and text prompts:  <i>DON'T TOUCH PATIENT PRESS FLASHING SHOCK BUTTON</i>



## Start with CPR Option

Your AED Pro unit may be configured to start a rescue with a CPR period of 30 to 180 seconds that begins after you power on the AED Pro unit. You can end this initial CPR period at any time by pressing the **Analyze** softkey. When you press the **Analyze** softkey, the AED Pro unit immediately begins analyzing the patient's ECG rhythm if the electrode pads are attached correctly. The **Analyze** softkey appears *only* during the initial CPR period and does not appear during any subsequent CPR periods unless it is configured to do so and/or the subsequent CPR intervals are set to Extended.

## Messages in Semiautomatic Mode

During semiautomatic mode, the unit can issue the following voice prompts and text messages. The unit issues each voice prompt only once, but the equivalent message remains on the screen until you take action, time expires, or the device status changes.

Message	Description
<i>UNIT OK</i>	The unit successfully passed the power-on self-test.
<i>UNIT FAILED</i>	The unit failed the power-on self-test and is not usable for patient care.
<i>CHANGE BATTERY</i>	The self-test detected a low energy condition that is insufficient for patient care. Replace the battery pack immediately.
<i>ADULT PADS</i> <i>PEDIATRIC PADS</i>	The unit detected the specified type of electrode pads and adjusted defibrillation energy settings accordingly.
<i>PLUG IN CABLE</i>	The unit started up without an electrode cable plugged in. Plug the cable into the unit.
<i>ATTACH DEFIB PADS TO PATIENT'S BARE CHEST</i>	The unit does not detect attachment of the defibrillation electrode pads to the patient.  Check the cable for damage.  Make sure that the pads are properly applied to the patient.  If this message continues, check the electrode sites to ensure that they are clean, dry, and free of excess hair. Check the expiration date on the electrode package.
<i>CHECK PATIENT</i>	Check the patient for responsiveness or consciousness by gently shaking the patient and shouting "Are you all right?"
<i>CHECK PULSE</i>	Check the patient for a pulse or other signs of circulation, such as normal breathing, movement, or coughing.
<i>START CPR</i>	Indicates the beginning of a CPR period. Begin CPR.
<i>STOP CPR</i>	Indicates the end of the CPR period. Discontinue CPR.
<i>DON'T TOUCH PATIENT, ANALYZING</i>	Indicates the beginning of an ECG analysis period. Make sure everyone stands clear of the patient. Keep the patient motionless during ECG analysis.
<i>NO SHOCK ADVISED</i>	ECG analysis did not detect a shockable rhythm.
<i>SHOCK ADVISED</i>	ECG analysis detected a shockable rhythm that requires therapy.

Message	Description
<i>DON'T TOUCH PATIENT</i>	The unit is analyzing the patient's ECG, charging the defibrillator, or holding a charge. Do not touch the patient.
<i>PRESS FLASHING SHOCK BUTTON</i>	After detecting a shockable rhythm, the unit is charged to the preselected energy level. Within 30 seconds, press the <b>Shock</b> button to deliver a shock to the patient.
<i>RELEASE SHOCK BUTTON</i>	The <b>Shock</b> button was depressed too soon. Wait until the unit issues the prompt <i>PRESS FLASHING SHOCK BUTTON</i> .
<i>CHECK DEFIB PADS</i>	The defibrillation electrode pads became disconnected. Check the pads to ensure that they are properly applied to the patient, and verify that the cable is undamaged and plugged into the unit.
<i>RELEASE LEFT SOFTKEY</i> or <i>RELEASE RIGHT SOFTKEY</i>	A softkey was pressed for more than 10 seconds. Release the softkey.
<i>ANALYSIS HALTED. KEEP PATIENT STILL.</i>	ECG rhythm analysis halted due to excessive ECG signal artifact. Stop CPR, and keep the patient as motionless as possible.
<i>SHOCK DELIVERED</i>	A shock was delivered to the patient.
<i>NO SHOCK DELIVERED</i>	No shock was delivered to the patient because the rescuer failed to press the <b>Shock</b> button, or an error condition was detected.
<i>STAY CALM</i>	Relax as much as possible and focus on the rescue effort.
<i>CALL FOR HELP</i>	Activate the local emergency medical services (EMS) system or ask a bystander to do it for you.
<i>OPEN AIRWAY</i>	Place the patient in the supine position and perform a head tilt, chin lift, or jaw thrust to open the patient's airway.
<i>CHECK BREATHING</i>	Look, listen, or feel for signs of breathing or airflow from the patient's lungs.
<i>GIVE TWO BREATHS</i>	If the patient is not breathing, give two rescue breaths.
<i>CONTINUE CPR</i>	(Optional prompt) Perform CPR until directed to stop.
<i>PUSH HARDER</i>	(With CPR-D-padz and CPR Stat-padz only) Apply more force so that chest compressions are at least 2 inches (5 cm) deep. Observe the compression indicator on the display screen.
<i>GOOD COMPRESSIONS</i>	(With CPR-D-padz and CPR Stat-padz only) The unit detected proper chest compression depth during CPR.





# Chapter 4

## Manual Mode

---

In manual mode, the AED Pro unit displays the patient's ECG, while the rescuer evaluates the rhythm to determine if a shock is needed. The rescuer can charge the unit to a preselected energy level. Once the defibrillator is fully charged, the rescuer presses the **Shock** button to deliver therapy.

**Note:** Manual mode is not available on AED-only models.

This chapter contains the following sections:

- “About Manual Mode” on page 4-2
- “Switching to Manual Mode” on page 4-3
- “Manual Defibrillation” on page 4-4
- “See-Thru CPR” on page 4-5
- “Messages in Manual Mode” on page 4-10

## About Manual Mode

In manual mode, you must evaluate the patient's rhythm to determine whether or not it is shockable. If a shock is required, you manually charge the defibrillator to the preselected energy level.

Once the defibrillator is fully charged, the **Shock** button begins flashing. The unit also emits a charge-ready tone to indicate that the defibrillator is ready to deliver a shock. The tone is continuous for the first 50 seconds and then sounds intermittently for 10 seconds more. Press the **Shock** button to deliver therapy.

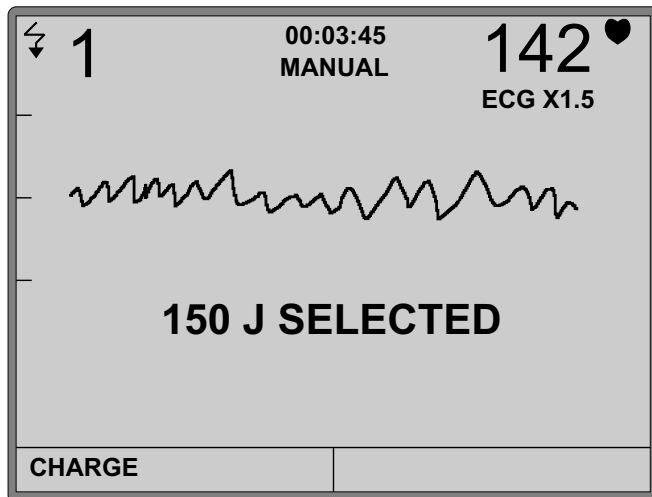
If you do not deliver a shock within this 60-second period, the defibrillator automatically disarms itself. To recharge the defibrillator, you must press the **CHARGE** softkey again.

---

**WARNING!** During shock delivery, do not touch the patient or any other equipment connected to the patient. A severe shock can result. To avoid unwanted pathways for defibrillation current, do not allow exposed portions of the patient's body to touch metal objects, such as a bed frame.

---

In manual mode, the screen shows the shock count, elapsed time, mode (MANUAL), heart rate, heartbeat symbol, ECG size, ECG rhythm, text messages, and the label **CHARGE** or **DISARM** above the left softkey.



## Switching to Manual Mode

When the unit is operating in semiautomatic mode, you can override the automated functions and switch to manual operation. Changing modes does not affect the preselected energy level.

### Before you begin

Be sure the defibrillation electrode pads are properly attached to the patient and are plugged into the unit. (For more information, refer to Chapter 3.)

### Procedure

To override semiautomatic mode and begin manual mode:

Step	Action	Result
1	Press and hold both (unlabeled) softkeys simultaneously for at least 3 seconds.	The <b>MANUAL</b> and <b>SEMI-AUTO</b> softkey labels appear.
2	To change to manual mode, press the <b>MANUAL</b> softkey. Or to remain in semiautomatic mode, press the <b>SEMI-AUTO</b> softkey. <b>Note:</b> If you do not press either softkey within 10 seconds, the unit reverts to semiautomatic mode.	The unit changes to manual mode, and displays the <b>CHARGE</b> softkey label.

To return to semiautomatic mode after manual override, turn the unit off and then back on again.

## Manual Defibrillation


With manual defibrillation, you must evaluate the ECG rhythm to determine whether or not it is shockable. If a shock is needed, you manually charge the defibrillator and then deliver a shock to the patient.

### Before you begin

Prepare the patient as described in “Applying Defibrillation Electrode Pads” on page 3-2.

### Procedure

To manually defibrillate the patient:

Step	Action	Result
1	<p>Press the <b>CHARGE</b> softkey to begin charging the defibrillator.</p> <p>If you need to disarm the defibrillator before it reaches full charge, press the <b>DISARM</b> softkey.</p>	<p>The unit displays the message:</p> <p style="text-align: center;"><i>DON'T TOUCH PATIENT, CHARGING</i></p> <p>The <b>CHARGE</b> softkey label changes to <b>DISARM</b>.</p> <p>The charge-ready tone indicates that the defibrillator is charged and ready. The <b>Shock</b> button flashes repeatedly.</p>
<p><b>WARNING! You have 60 seconds to perform the following step, otherwise the defibrillator automatically disarms itself. (During the final 10 seconds, the charge-ready tone sounds intermittently to indicate that time is expiring.)</b></p> <p><b>Before discharging the defibrillator, warn everyone to STAND CLEAR. Verify that no one is touching the patient, the bed rails, or any other potential pathway for electrical current.</b></p>		
2	<p>Press and hold the <b>Shock</b> button until treatment is delivered.</p> <div style="text-align: center;">  </div> <p>Or to disarm the defibrillator, press the <b>DISARM</b> softkey.</p>	<p>The unit delivers the shock to the patient.</p> <p>The unit updates the shock count and shows the energy level for the next shock:</p> <p style="text-align: center;"><i>XXX J SELECTED</i></p>
3	<p>Continue evaluating the patient.</p> <p>If additional shocks are needed, repeat this procedure.</p>	

## See-Thru CPR

See-Thru CPR<sup>®</sup> enables the rescuer to see a close approximation of the patient's underlying ECG rhythm while performing CPR. See-Thru CPR is an optional feature that must be configured using the ZOLL Administration Software.

Chest compressions introduce *CPR artifact* into the ECG signal. See-Thru CPR uses a filter that relies on the correlation between CPR compressions, as detected by the ZOLL CPR-D-padz or CPR Stat-padz electrodes, and the CPR artifact to remove much, but not all, of the artifact from the ECG signal. Under some conditions, residual noise after filtering can obscure the ECG rhythm, requiring the rescuer to stop CPR to assess the ECG. For example, in the case of asystole or low amplitude PEA, the residual artifact seen after filtering may look like fine ventricular fibrillation.

Because the filtered ECG signal may contain residual chest compression and/or filtering artifacts, *a rescuer should always follow the standard protocol of stopping CPR to assess the patient's ECG rhythm before determining treatment.*

### Using See-Thru CPR

To use See-Thru CPR:

- The AED Pro unit must be operating in Manual Mode.
- CPR-D-padz or CPR Stat-padz electrodes must be attached to the unit.
- The AED Pro unit must be configured to use See-Thru CPR (using the ZOLL Administration Software).

When a rescue begins, an AED Pro unit that has been configured to use See-Thru CPR *automatically* starts filtering the CPR artifact after detecting the first 3 to 6 chest compressions. The filtered ECG is displayed along with the *CPR FLTR* message on the top left of the LCD screen.

See-Thru CPR filtering continues as long as the CPR-D-padz or CPR Stat-padz electrodes detect compressions. When no compressions are detected, filtering stops, unfiltered ECG signals are displayed, and the unit removes the *CPR FLTR* message from the LCD screen. When compressions resume, filtering automatically restarts after 3 to 6 chest compressions.

#### WARNINGS



- The See-Thru CPR filter works only when the AED Pro defibrillator is operating in Manual Mode.
- The See-Thru CPR filter does not remove all CPR artifact. Always stop CPR to verify the patient's ECG rhythm before making treatment decisions.
- The See-Thru CPR filter does not operate during ECG rhythm analyses. Always stop chest compressions during ECG rhythm analyses to avoid incorrect results caused by the presence of CPR artifact.

### Examples

The following examples show the effects of See-Thru CPR filtering on ECG signals contaminated with CPR artifact.

Each example includes:

- ECG signal with CPR artifact.
- ECG signal after the See-Thru-CPR filter has removed CPR artifact.
- Indication of the period during which See-Thru CPR is active.
- CPR signal to show when CPR activity occurred.

Figure 1 shows a patient in Fine VF. It is difficult for a rescuer to discern this rhythm during CPR compressions. When the CPR filter turns on, the Fine VF rhythm becomes more obvious.

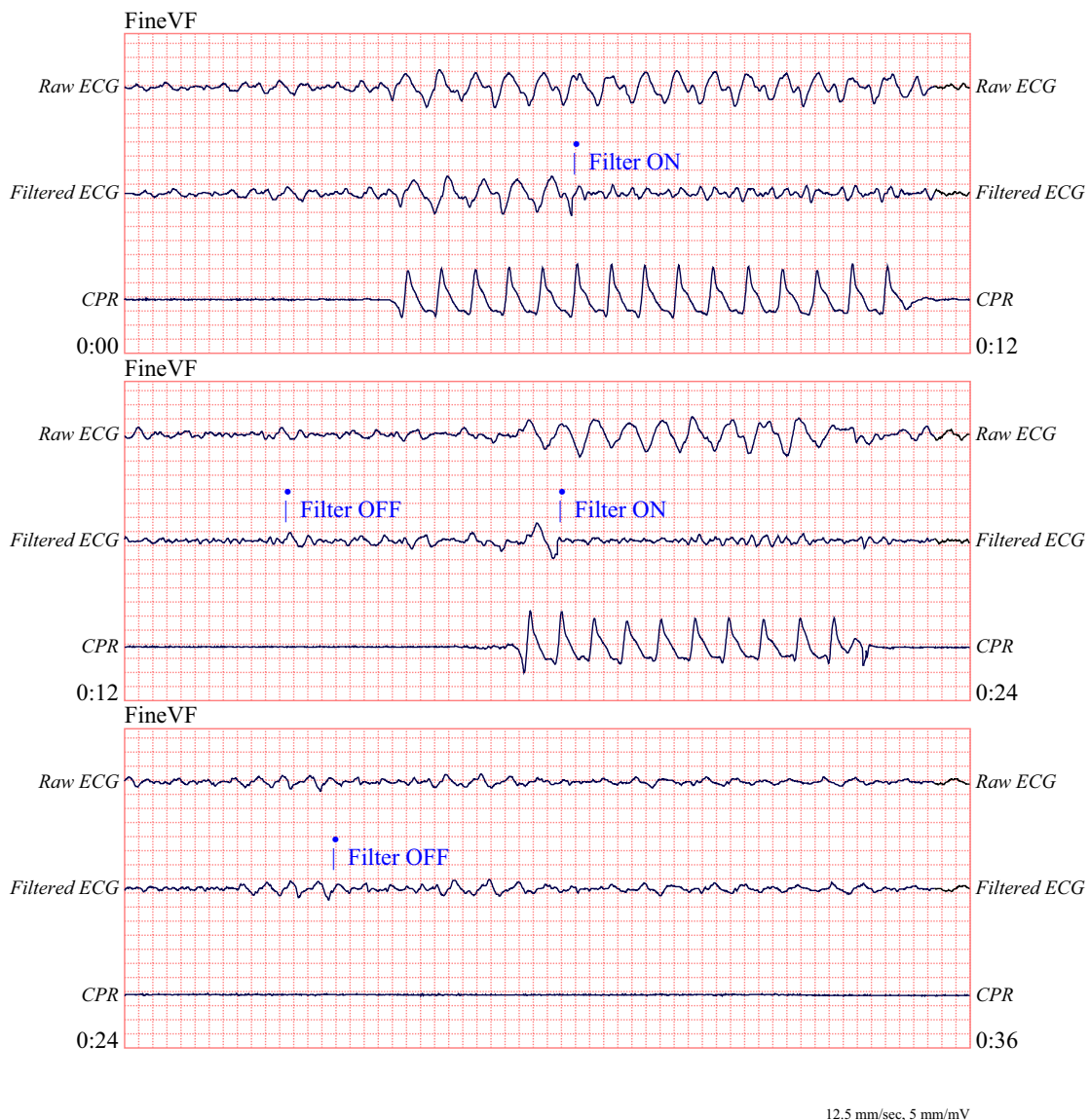


Figure 1.

Figure 2 shows a patient in VF, which during compressions, is slightly more difficult to discern. When viewing this ECG, it is possible to view the underlying rhythm as the filter is able to reject all of the CPR artifact.

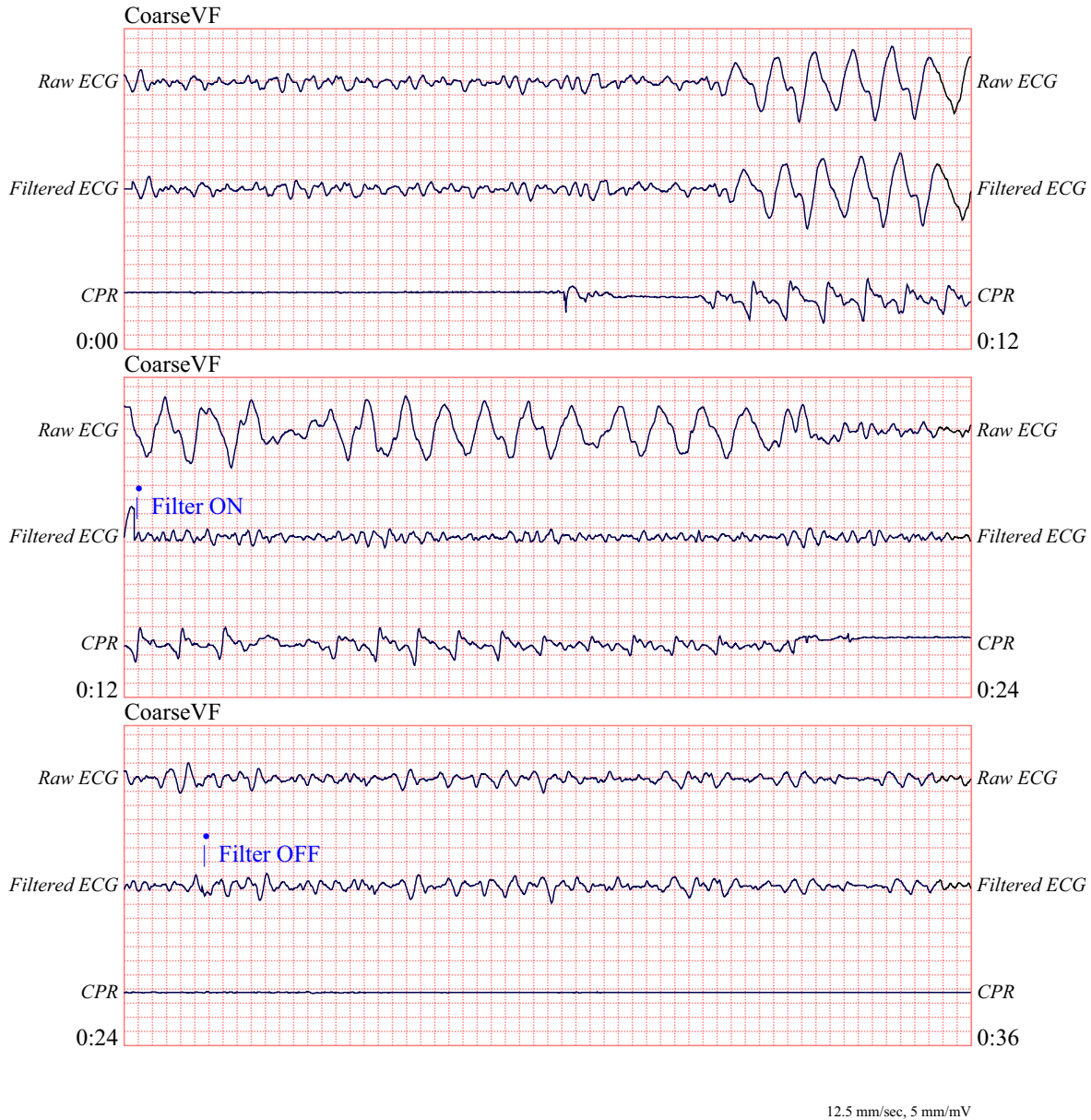


Figure 2.

Figure 3 shows a patient in PEA, which could easily be mistaken for Fine VF because enough of the compression artifact leaks through to distort this signal. When the CPR filter turns on, the PEA is still not obvious because of the left over ripples from the CPR signal. About 14 seconds into this chart, the rhythm changes to asystole, which could easily be mistaken for coarse VF. When the CPR filter turns on, the CPR compression ripples are still obvious, making the rhythm look like Fine VF.



Figure 3.



Figure 4 shows a patient with an organized rhythm where See-Thru CPR effectively filters out artifact created by CPR.



Figure 4.

## Messages in Manual Mode

During manual mode, the following messages can be displayed:

Message	Description
<i>PLUG IN CABLE</i>	The unit started up without an electrode cable plugged in. Plug the cable into the unit.
<i>CHECK DEFIB PADS</i>	The defibrillation electrode pads became disconnected. Check the pads to ensure that they are properly applied to the patient, and verify that the cable is undamaged and plugged into the unit.
<i>CHECK PATIENT</i>	Evaluate the status of the patient. The unit detected either a shockable rhythm or a low heart rate.
<i>DON'T TOUCH PATIENT, CHARGING</i>	The defibrillator is charging. Do not touch the patient.
<i>RELEASE SHOCK BUTTON</i>	The <b>Shock</b> button was pressed while the unit was charging. Do not press the <b>Shock</b> button until the unit emits the charge-ready tone, and the button begins flashing.
<i>RELEASE LEFT SOFTKEY</i> or <i>RELEASE RIGHT SOFTKEY</i>	A softkey was pressed for more than 10 seconds; the unit automatically switched to semiautomatic mode. Release the softkey.

# Chapter 5

## ECG Monitoring Mode

---

You can use the AED Pro unit for short-term monitoring of the patient's electrocardiogram (ECG). The AED Pro unit monitors lead II only.

Rescue protocol voice prompts are disabled in ECG monitoring mode.

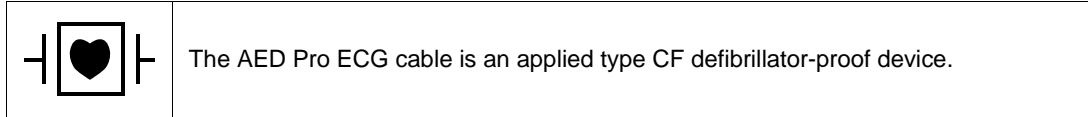
This chapter contains the following sections:

- “About ECG Monitoring” on page 5-2
- “ECG Electrode Placement” on page 5-3
- “Applying ECG Electrodes” on page 5-4
- “Monitoring the ECG Rhythm” on page 5-6
- “Messages in ECG Monitoring Mode” on page 5-8

## About ECG Monitoring

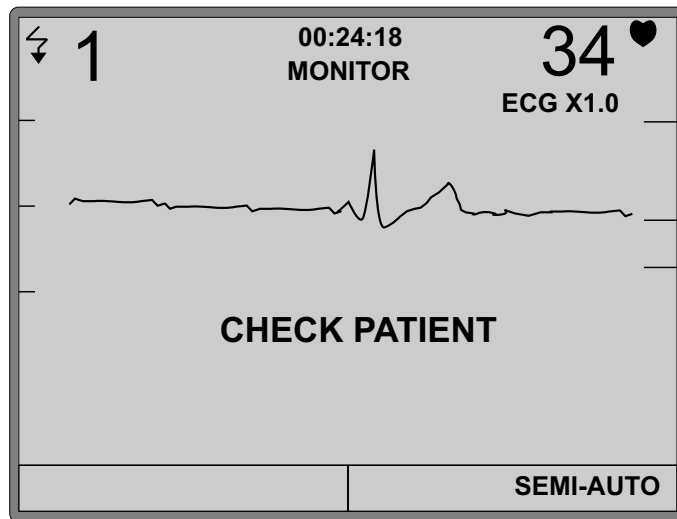
For ECG monitoring, you can use

- Standard ECG electrodes (with an AED Pro ECG cable)
- AED Pro-compatible defibrillation electrode pads



In ECG monitoring mode, the screen shows the shock count, elapsed time, mode (MONITOR), heart rate, heartbeat symbol, ECG size, ECG rhythm, and text messages.

If defibrillation electrode pads are in use, the label **SEMI-AUTO** appears above the right softkey.



**WARNING!** An implanted pacemaker might cause the heart rate meter or ECG rhythm analysis to count the pacemaker rate during incidents of cardiac arrest or other arrhythmia.

Carefully observe pacemaker patients. Check the patient's pulse; do not rely solely on the heart rate meter. Patient history and physical examination are important in determining the presence of an implanted pacemaker.

The ECG and heart rate monitoring functions of the AED Pro are intended for diagnosing significant heart rate and rhythm conditions for the purposes of out-of-hospital emergency medical treatment. These may include tachycardia, bradycardia, ectopic heart beats, ventricular fibrillation and other similar conditions characterized by significant changes in ECG rhythm.

**WARNING!** These functions are not intended to be used for discerning fine changes in the morphology of individual ECG component waves.

# ECG Electrode Placement

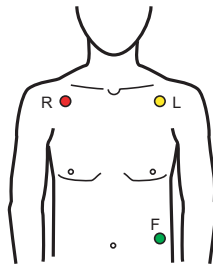
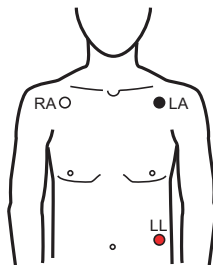
Before applying ECG electrodes, be sure to

- Remove all clothing covering the patient’s chest.
- Clip or shave any excessive hair to ensure proper adhesion of the electrodes.
- Use alcohol to wash away any oil or dirt at the electrode site.
- Dry any moisture at the electrode site.

Some skin abrasion is necessary to remove the top layer of dead skin cells and expose moist living cells for better electrical contact. Proper skin preparation reduces baseline wander and noise and provides a noise-free signal more quickly after electrode application.

Place ECG electrodes on the patient’s chest as shown in Table 5-1.

**Table 5-1. ECG Electrode Labeling and Placement**

IEC <sup>a</sup> Label	AHA <sup>b</sup> Label	Placement	
R (red)	RA (white)	Patient’s right midclavicular line, directly below clavicle.	<div style="display: flex; flex-direction: column; align-items: center;"> <div style="display: flex; align-items: center; margin-bottom: 20px;"> <div style="margin-right: 10px;">3-lead configuration (IEC)</div>  </div> <div style="display: flex; align-items: center;"> <div style="margin-right: 10px;">3-lead configuration (AHA)</div>  </div> </div>
L (yellow)	LA (black)	Patient’s left midclavicular line, directly below clavicle.	
F (green)	LL (red)	Between sixth and seventh intercostal space on the patient’s left midclavicular line.	

a. International Electrotechnical Commission  
 b. American Heart Association

## Applying ECG Electrodes

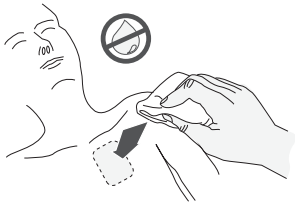
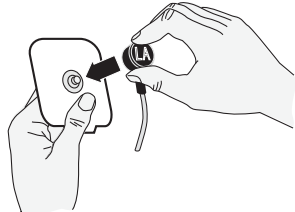
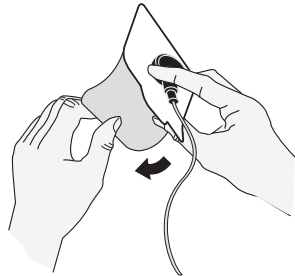
Proper application and placement of electrodes is essential for ECG monitoring. Good contact between the electrode and the skin minimizes motion artifact and signal interference. ZOLL recommends the use of high-quality Ag/AgCl (silver/silver chloride) ECG electrodes.

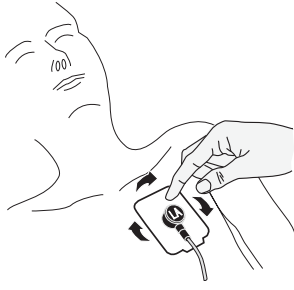
### Before you begin

Check the electrodes to ensure they are free from damage and are not past the expiration date on the packaging.

### Procedure

To apply ECG electrodes to the patient:

Step	Action	
1	Identify the appropriate sites for electrode placement (refer to "ECG Electrode Placement" on page 5-3).	
2	Clean and abrade the patient's skin to remove the outer layer of dead tissue. Ensure that the skin at the electrode site is dry.	
3	Snap the leads onto each electrode. Check for good contact between the electrode and the lead termination.	
4	Peel the protective backing from the ECG electrode. Keep the adhesive surface free of electrolyte gel. <b>WARNING!</b> Do not use electrodes if the gel is dried or damaged.	

Step	Action
5	<p>Apply the adhesive side of each ECG electrode firmly to the patient's skin, pressing around the entire perimeter of the electrode.</p>  An illustration showing a hand applying an ECG electrode to a patient's chest. The patient's head is tilted back, and the hand is shown pressing the electrode onto the skin. The electrode has a circular adhesive pad and a cable attached. The hand is shown from the side, with fingers pressing the electrode onto the chest.
6	<p>Plug the ECG cable into the patient cable connector on the unit.</p> <p><b>Note:</b> Arrange the ECG cable so that it does not pull on any of the electrodes.</p>

## Monitoring the ECG Rhythm

You can monitor a patient's ECG using standard ECG electrodes or defibrillation electrode pads.

### Monitoring with ECG Electrodes

When it detects an AED Pro ECG cable at startup, the unit enters ECG monitoring mode (if monitoring mode is enabled) and displays the patient's ECG rhythm and heart rate.

#### Procedure

To start and operate the unit in ECG monitoring mode:

Step	Action	Result
1	Be sure the AED Pro ECG cable is plugged into the unit, the electrodes are snapped onto the cable, and the electrodes are attached to the patient.	
2	Press and release the <b>On/Off</b> button to turn on the unit.	The unit starts up and the screen displays <b>MONITOR</b> as the current mode.
3	Allow the unit to monitor the patient's ECG.	<p>If it detects a shockable rhythm while monitoring, the unit issues the voice and text prompts:</p> <p style="text-align: center;"><i>CHECK PATIENT PLUG IN DEFIB CABLE</i></p> <p>The latter message remains on screen until defibrillation pads are attached.</p> <p>If the detected heart rate is lower than the configured minimum heart rate limit, the unit issues the voice and text prompt:</p> <p style="text-align: center;"><i>CHECK PATIENT</i></p> <p>This message remains on screen as long as the patient's heart rate is below the limit.</p>
4	<p>If prompted, check the patient.</p> <p>If prompted to plug in defibrillation cable, replace the ECG electrodes and cable with defibrillation electrode pads.</p>	<p>If it detects defibrillation pads, the unit changes to semiautomatic mode.</p> <p>For more information, refer to Chapter 3, "Semiautomatic Mode".</p>



## Monitoring with Defibrillation Electrodes

With defibrillation electrodes in use, you can change from semiautomatic mode to ECG monitoring mode.

If the unit detects a shockable rhythm while in ECG monitoring mode and defibrillation electrodes are in use, the unit prompts you to check the patient and then changes to semiautomatic mode.

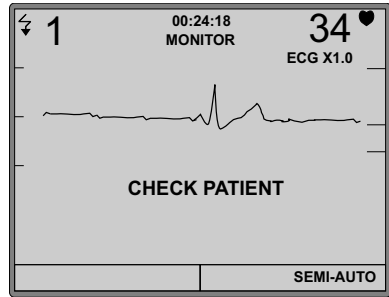
For more information, refer to Chapter 3, “Semiautomatic Mode”.

### Before you begin

Attach defibrillation electrode pads to the patient (refer to Chapter 3.)

### Procedure

To change from semiautomatic to ECG monitoring mode:

Step	Action	Result
1	Press and hold the left (unlabeled) softkey for at least 5 seconds.	The unit displays <b>MONITOR</b> as the current mode, and the <b>SEMI-AUTO</b> softkey label appears.  The image shows a rectangular monitor screen. At the top left is a battery icon and the number '1'. At the top center is a timer '00:24:18' and the word 'MONITOR'. At the top right is the number '34' with a heart icon, and below it 'ECG X1.0'. In the center of the screen is an ECG waveform. Below the waveform, the text 'CHECK PATIENT' is displayed. At the bottom right of the screen, the text 'SEMI-AUTO' is visible.
2	Monitor the patient's ECG.	If it detects a shockable rhythm while monitoring, the unit prompts you to check the patient and changes to semiautomatic mode.
3	To manually return to semiautomatic mode, press and release the <b>SEMI-AUTO</b> softkey.	

## Messages in ECG Monitoring Mode

The following voice prompts and text messages can occur while using the unit for ECG monitoring:

<b>Message</b>	<b>Description</b>
<i>CHECK PATIENT</i>	ECG monitoring detected a shockable rhythm or low heart rate. Evaluate the status of the patient.
<i>PLUG IN DEFIB CABLE</i>	The unit detected a shockable rhythm while monitoring the patient with ECG electrodes. An ECG cable was plugged in, but the unit is not configured for ECG monitoring. Plug in the defibrillation cable.
<i>CHECK ECG ELECTRODES</i>	Ensure that the ECG electrodes are properly attached to the patient and that the cable is plugged into the unit.
<i>CHECK DEFIB PADS</i>	Ensure that the defibrillation electrode pads are properly attached to the patient and that the cable is plugged into the unit.
<i>ATTACH DEFIB PADS TO PATIENT'S BARE CHEST</i>	The unit does not detect attachment of the defibrillation electrode pads to the patient. Attach defibrillation pads to the patient.

# Chapter 6

## Nonrescue Mode

---

For the AED Pro device, Nonrescue Mode includes:

- Managing device history and clinical data
- Configuring the device

The unit includes nonvolatile memory for storing device status and clinical event information. You can retrieve stored data using a personal computer or personal digital assistant with ZOLL RescueNet Code Review software through a USB device or an IrDA connection with the AED Pro unit.

You can configure an AED Pro device using a personal computer with ZOLL Administration Software (ZAS) through an IrDA connection with the unit.

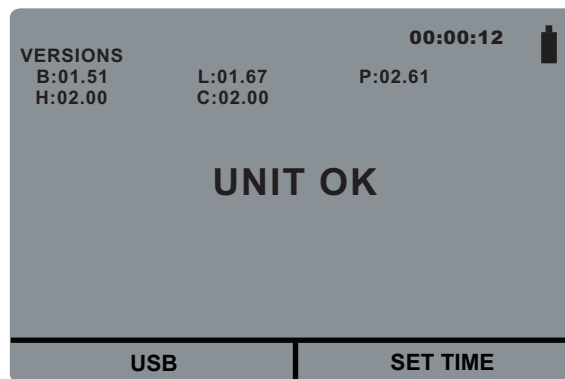
This chapter contains the following sections:

- “Entering Nonrescue Mode” on page 6-2
- “Data Storage” on page 6-3
- “Communicating with an External Device” on page 6-4
- “Setting the Date and Time” on page 6-5
- “Device Configuration” on page 6-6
- “ZOLL Administration Software” on page 6-6
- “Messages in Nonrescue Mode” on page 6-8

## Entering Nonrescue Mode

To place the AED Pro unit in Nonrescue Mode:

Step	Action	Result
1	If the unit is on, press and hold the <b>On/Off</b> button for 1 second to turn off the unit.  Wait until the message <i>POWERING OFF</i> disappears.	The unit powers off.
2	Press and hold the <b>On/Off</b> button for at least 5 seconds.	The unit issues the voice and text message:  <i>UNIT OK</i>



If using an IrDA connection, make sure the connection is established before starting the AED Pro unit. Refer to “Setting Up Data Communications with an IrDA Connection” on page 6-4.

## Data Storage

The AED Pro unit stores device history and patient clinical data in nonvolatile memory.

The unit retains the device history and clinical data even when powered off or when the battery pack is removed. Clinical data is erased only when the device is powered on and electrodes are attached to a new patient. If configured to do so, the unit can store data for more than one patient.

## Device History

The AED Pro unit keeps a log of its status information, including:

- Unit model name
- Device serial number
- Hardware revision number
- Application software and boot code revision numbers
- Language file version number
- Total shocks delivered
- Battery life status (percentage of charge remaining)
- Ready indicator status
- Elapsed time since installation of the battery
- Date and results of last self-test
- Error log

To view device history, use ZOLL Administration Software.

## Patient Clinical Data

During clinical mode, the device stores the following, with date and time notation:

- Electrode attachment
- Electrode type (CPR-D-padz, CPR Stat-padz, Stat-padz II, or Pedi-padz II defibrillation pads, or AED Pro ECG cable)
- Results of ECG analysis
- Continuous ECG data
- Number of shocks delivered
- Energy delivered
- Patient impedance
- Voice prompts
- CPR data (depth and rate of chest compressions)

To view and analyze patient clinical data, use ZOLL RescueNet Code Review software.

## Communicating with an External Device

For many nonrescue operations (such as data transfer or device configuration), the AED Pro unit must establish a connection with an external device.

### Setting Up Data Communications with an IrDA Connection

You can transfer data from an AED Pro unit to an external device through an IrDA (infrared wireless) connection. The AED Pro unit has an IrDA port on its right side, near the Ready indicator. The external device (such as a personal computer or personal digital assistant) must have an IrDA port as well. For IrDA adapters, refer to “Accessories” on page 1-6.

For best transmission results, the IrDA ports must be facing each other, with a clear 10- to 18-inch line-of-sight between devices.

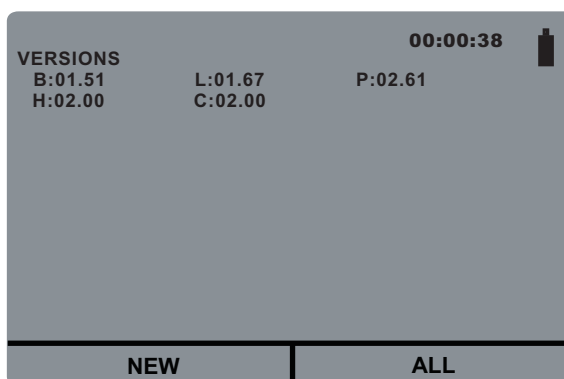
Start the ZOLL Administration Software or RescueNet Code Review software on the computer. Press and hold the **On/Off** button on the AED Pro unit for at least 5 seconds to enter nonrescue mode (see page 6-2). The AED Pro unit establishes contact with the computer within 5 seconds and issues the voice and text message *COMMUNICATIONS ESTABLISHED*; otherwise, it shuts down.

### Downloading Data to a USB Device

You can also download patient data to a portable USB device for use with RescueNet Code Review software.

Press and hold the **On/Off** button on the AED Pro unit for at least 5 seconds to enter nonrescue mode (see page 6-2). Attach a USB device to the port inside the battery compartment, then press the **USB** softkey. The unit issues the voice and text message *USB DEVICE CONNECTED*.

Press the **New** softkey to download all new patient data since the last download. Press the **All** softkey to download all patient data on the unit. The unit issues the voice and text message *DOWNLOADING DATA*.



If there is no USB device attached, or if the unit fails to establish a connection with the USB device, the unit issues the command *INSERT USB DEVICE*.



---

**WARNING!** Do not connect the AED Pro to a PC or other device (via the USB port) while the unit's electrodes are still connected to the patient.

---

When the AED Pro has finished downloading data, it issues the prompt *DATA DOWNLOAD COMPLETE* and then immediately powers off. To ensure that the unit has finished writing to the device, wait 5 seconds or until the unit powers off before removing the device from the unit. You can now plug your USB device into a PC for use with the RescueNet Code Review software.

**Note:** While in Nonrescue Mode, the AED Pro allows you to download data to a USB device at any time, with or without an IrDA connection established.

While in the USB menu, if no softkeys are pressed and there is no IrDA connection established, the unit powers off after 30 seconds.

## Setting the Date and Time

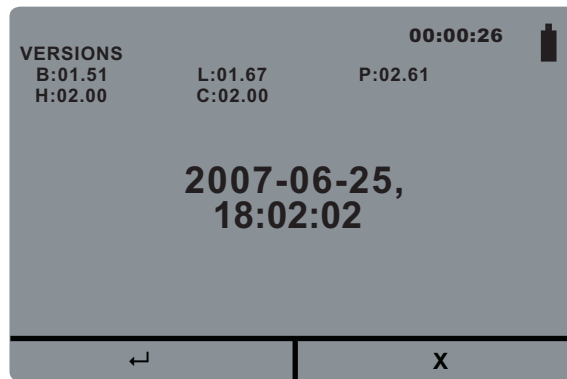
To set the current date and time in the AED Pro, make sure that you are in Nonrescue Mode by holding down the **On/Off** button for 5 seconds (see page 6-2).

Press the **SET TIME** softkey. The unit then prompts you to set the year, month, day, hour, minute, and second. To advance to each subsequent screen, press the **→** softkey.

- **SET YEAR:** Press the **+** softkey to advance to the desired year, using numbers 2000 through 2037. Press the **→** softkey to advance to the next screen.
- **SET MONTH:** Press the **+** softkey to advance to the desired month, using numbers 01 through 12.
- **SET DAY:** Press the **+** softkey to advance to the desired day, using numbers 01 through 31.
- **SET HOUR:** The AED Pro has a 24-hour clock. Press the **+** softkey to advance to the desired hour, using numbers 01 through 24.
- **SET MINUTE:** Press the **+** softkey to advance to the desired minute, using numbers 00 through 59.
- **SET SECOND:** Press the **+** softkey to advance to the desired second, using numbers 00 through 59.

**Note:** You cannot go backwards when scrolling through the numbers. If you go past the number you want, keep pressing the **+** softkey until it resets to the desired number.

The unit then displays the selected date and time. To save changes, press the **↵** softkey. The text message *SAVING DATA* appears. To cancel changes and revert to the previously set date and time, press the **X** softkey.



While in the SET TIME menu, if no softkeys are pressed and there is no IrDA connection established, the unit powers off after 30 seconds.

## Device Configuration

The AED Pro unit provides configurable settings to suit the needs of your organization and its medical protocols. Before putting the unit into service for the first time, the administrator should inspect the factory settings and make any required adjustments.

Operators cannot adjust these settings while the unit is in clinical use.

For more information, refer to Appendix C, “Configurable Settings.”

## ZOLL Administration Software

ZOLL Administration Software (ZAS) helps you perform software maintenance tasks when the AED Pro unit is communicating with a personal computer. Using ZAS, you can transfer data from the AED Pro unit to a computer. From the computer, you can transmit the data to a network or print the data to a local printer.

For instructions on using ZAS, refer to its online help.

## Installing ZOLL Administration Software

To install ZOLL Administration Software, insert the ZOLL Administration Software CD into a CD-ROM drive on the computer. The installation program starts automatically.

If the installation program does not start, do the following:

1. From the Windows Start menu, select **Run**.
2. In the Open field, type  
`x:setup.exe`  
(where x is the letter of the CD-ROM drive that contains the ZAS CD).
3. Click **OK**.

Follow the on-screen instructions to complete the installation.



## RescueNet Code Review Software

To analyze incident information transferred from the AED Pro unit to a personal computer, use RescueNet Code Review software. With this software, you can

- Transfer patient data from the AED Pro unit to a personal computer
- Access and review patient case data
- Add or modify patient information
- View an animated ECG
- Annotate the ECG
- Print ECG stripcharts and case reports

For more information, refer to the *RescueNet Code Review User's Guide*.

## Messages in Nonrescue Mode

The unit can display the following messages when exchanging data:

<b>Message</b>	<b>Description</b>
<i>COMMUNICATIONS ESTABLISHED</i>	The unit successfully contacted an external IrDA device.
<i>DATA DOWNLOAD COMPLETE</i>	Data transfer was successful.
<i>DATA DOWNLOAD FAILED</i>	Data transfer halted because the external device detected an error or the operator canceled transmission through the communication program.  Check the communications package or utility on the external device for the source of the error.
<i>NON-RESCUE MODE</i>	The unit is operating in nonrescue mode and connected to an external IrDA device.
<i>USB DEVICE CONNECTED</i>	The unit recognizes that an external USB device has been connected.
<i>USB DEVICE FULL</i>	The attached USB device is full, and cannot receive data.
<i>INSERT USB DEVICE</i>	Prompts you to insert a USB device into the USB port located inside the battery compartment.
<i>NO DATA</i>	There is no new patient data to download to the USB device.

# Chapter 7

## Troubleshooting and Maintenance

---

To ensure that the AED Pro unit is functioning properly and is ready for use in an emergency, general maintenance procedures should be performed before putting the unit into service and after each clinical use.

This chapter contains the following sections:

- “General Troubleshooting” on page 7-2
- “ECG Monitoring Troubleshooting” on page 7-4
- “Defibrillator Troubleshooting” on page 7-5
- “Cleaning the Unit” on page 7-6
- “Optional Maintenance for Technical Professionals” on page 7-7

If trouble persists after consulting this chapter, contact the appropriate technical personnel or ZOLL Technical Service Department.

## General Troubleshooting

Table 7-1 lists general issues with the unit and their associated corrective action.

**Table 7-1. General Issues**

Symptom	Corrective Action
Unit beeps or displays a red "X" while turned off.	Turn the unit on. Follow the prompts to resolve the problem.  If the unit continues to fail, take it out of service, and contact ZOLL Technical Service.
Ready indicator shows a red "X" while the device is powered on.	Turn the unit off and then on again. Follow the prompts to resolve the problem.  If the unit continues to fail, take it out of service, and contact ZOLL Technical Service.
Power-on self-test failed.	Follow the prompts to resolve the problem.  If the unit continues to fail, take it out of service, and contact ZOLL Technical Service.
Unexpected shutdown in clinical mode.	<b>Note:</b> In clinical mode, the unit automatically powers off if it does not detect a patient connection within 10 minutes (configurable).  Turn the unit on. Follow the prompts to resolve the problem.  If the unit continues to fail, take it out of service, and contact ZOLL Technical Service.
Unexpected shutdown in nonrescue mode.	<b>Note:</b> The unit automatically powers off if an established IrDA connection is lost.  Press and hold the <b>On/Off</b> button for at least 5 seconds. Follow the prompts to resolve the problem.  If the unit still is not ready for use, take it out of service. Contact ZOLL Technical Service.
Message: <i>CHANGE BATTERY</i>	Replace the battery pack with a fully charged battery pack as soon as possible.
Message: <i>PLUG IN CABLE</i>	Ensure that the electrode cable is properly connected to the unit.  Remove the cable and check for bent or broken pins.  Replace the electrode cable.
Message: <i>RELEASE SHOCK BUTTON</i>	Release the <b>Shock</b> button. Wait until the unit issues the prompt <i>PRESS FLASHING SHOCK BUTTON</i> before pressing the button.

Table 7-1. General Issues (continued)

Symptom	Corrective Action
Message: <i>PLUG IN DEFIB CABLE</i>	<b>Note:</b> This prompt appears if an ECG cable is connected, but the unit is not configured for ECG monitoring.  Check the cable, and replace if necessary.
Message: <i>RELEASE LEFT SOFTKEY</i> or <i>RELEASE RIGHT SOFTKEY</i>	A softkey was pressed for more than 10 seconds; the unit automatically switched to semiautomatic mode.  Release the softkey.

## ECG Monitoring Troubleshooting

Table 7-2 lists common issues with ECG monitoring and their associated corrective action.

**Table 7-2. ECG Monitoring Issues**

Symptom	Corrective Action
Messages: <i>CHECK ECG ELECTRODES</i> <i>ATTACH ECG ELECTRODES</i>	Ensure that the ECG cable is connected to each electrode and to the unit.  Ensure that the ECG electrodes are making good contact with the patient and are not dried out.  Replace the ECG electrodes.  Replace the ECG cable.
Noisy ECG, artifact, or wandering baseline.	Turn off nearby two-way radios and cell phones.  Before attaching electrodes, properly prepare the patient's skin (refer to "Applying ECG Electrodes" on page 5-5).  Check for proper adhesion of the electrodes to the patient.  Arrange the cable and leads so that they do not pull on the electrodes or swing excessively.
Poor ECG signal level.	Replace the ECG electrodes, and change their position on the patient.
Irregular heart rate.	Observe the patient's ECG. Verify that the irregular heart rate is not caused by noise, low amplitude R waves, extra-systoles, or arrhythmias.  Replace the ECG electrodes, and change their position on the patient.
Message: <i>PLUG IN DEFIB CABLE</i>	ECG analysis detected a shockable rhythm.  Replace the ECG electrodes and cable with defibrillation pads to deliver therapy.
ECG data recording stops.	If the unit is turned off and then turned on again within 10 seconds, ECG recording is interrupted.

# Defibrillator Troubleshooting

Table 7-3 lists common issues with defibrillation and their associated corrective action.

**Table 7-3. Defibrillator Issues**

Symptom	Corrective Action
Defibrillator does not charge.	<p>The patient's ECG rhythm is not shockable because it is not either ventricular fibrillation (VF) or wide complex ventricular tachycardia (VT), or is VF with amplitude less than 100 <math>\mu</math>V (semiautomatic mode only). Verify the rhythm.</p> <p>Confirm that the defibrillation cable is plugged in and the pads are attached to the patient.</p> <p>Install a fully charged battery pack.</p>
Defibrillator takes more than 15 seconds to charge.	Install a fully charged battery pack.
Energy does not discharge when the <b>Shock</b> button is pressed.	<p>A fully charged defibrillator automatically disarms itself after 60 seconds in manual mode or 30 seconds in semiautomatic mode. Charge the defibrillator again, and deliver the shock while the charge-ready tone sounds.</p> <p>The <b>Shock</b> button was pressed before the unit was fully charged. Wait for the charge-ready tone and a flashing <b>Shock</b> button before pressing and holding the <b>Shock</b> button.</p>
No apparent energy delivery to patient.	<p>Under certain circumstances, a patient might not display a physical reaction when energy is delivered.</p> <p>Replace the electrodes if they are dried out or expired.</p> <p>Ensure that the electrodes are making proper contact with the patient's skin.</p> <p>Test the defibrillator. (Refer to "Optional Maintenance for Technical Professionals" on page 7-7.)</p> <p>If the message <i>CHECK DEFIB PADS</i> appears, check and correct the attachment or position of the electrodes.</p>
Message: <i>CHECK DEFIB PADS</i>	<p>Ensure that the defibrillation electrode pads are making proper skin contact and that patient does not have excessive hair beneath electrodes.</p> <p>If message persists, change the defibrillation cable.</p>
Message: <i>ANALYSIS HALTED. KEEP PATIENT STILL.</i>	<p>Check for proper application and adhesion of the defibrillation electrode pads.</p> <p>Ensure that no one is touching the patient and that the patient is motionless during ECG analysis.</p>
Message: <i>DEFIB MAINTENANCE REQUIRED</i>	Contact ZOLL Technical Service.

## Cleaning the Unit

After each use, clean and disinfect the unit and ECG cables with a soft, damp cloth using any of the following cleaning agents:

- Soap and water
- Chlorine bleach solution (30 milliliters per liter of water)
- 90% isopropyl alcohol

The AED Pro unit and its accessories are chemically resistant to most common cleaning solutions and noncaustic detergents.

Refer to the “Cautions” on page x.



# Optional Maintenance for Technical Professionals

The AED Pro is calibrated at the factory and requires no testing other than the self-tests it performs. Qualified professionals who want to perform additional tests can use the following procedure.

## Required equipment

- AED Pro simulator (or equivalent)

## Before you begin

Be sure the unit and the simulator/tester are turned off.

## Procedure

To test the unit:

Step	Action
1	Connect the AED Pro simulator to the unit's patient cable connector.
2	Power on the simulator and the AED Pro unit.
3	Verify that all of the following occur: <ul style="list-style-type: none"> <li>• The Ready indicator initially displays a red "X", which changes to a green check within 10 seconds after the unit is turned on.</li> <li>• The unit issues the voice and text message <i>UNIT OK</i> within 10 seconds (if configured).</li> <li>• The screen displays the shock count and the elapsed time.</li> </ul>
4	Set the simulator to send a VF rhythm to the AED Pro unit.
5	After the sequence of patient assessment prompts, verify that the unit does the following: <ul style="list-style-type: none"> <li>• Issues the voice and text prompt <i>DON'T TOUCH PATIENT, ANALYZING</i>.</li> <li>• Analyzes the ECG rhythm.</li> <li>• Issues the voice and text message <i>SHOCK ADVISED</i>.</li> <li>• Charges the defibrillator.</li> <li>• Issues the voice and text prompts <i>DON'T TOUCH PATIENT</i> and <i>PRESS FLASHING SHOCK BUTTON</i>.</li> </ul>
6	Verify that the AED Pro unit sounds the charge-ready tone and that the <b>Shock</b> button flashes repeatedly.
7	Press the <b>Shock</b> button. Verify that the simulator indicates that a shock was delivered and that the unit updates the displayed shock count. <p><b>Note:</b> The simulator can verify the unit's ability to deliver energy but cannot verify that the correct energy was delivered. To verify the level of delivered energy, use a defibrillator analyzer and universal adapter cable in place of the simulator.</p>
8	Immediately after shock delivery, change the simulator to send a normal sinus rhythm (NSR) to the AED Pro unit.
9	Verify that the AED Pro unit performs a new rhythm analysis, resulting in the message <i>NO SHOCK ADVISED</i> , followed by the voice and text prompt: <i>START CPR</i>

Step	Action
10	Activate the simulator's CPR function.
11	Verify that the metronome begins to beep. Verify that the AED Pro unit issues the following voice and text prompts within 60 seconds (unless CPR monitoring is disabled on the unit): <i>PUSH HARDER</i> <i>GOOD COMPRESSIONS</i> Verify that the chest compression gauge functions properly.
12	After approximately 2 minutes of CPR, verify that the unit issues the voice and text prompt <i>STOP CPR</i> .
13	Verify that the AED Pro unit begins a new ECG analysis.
14	Turn off the AED Pro unit and the simulator.
15	Verify that the Ready indicator displays a green check before disconnecting the simulator and attaching defibrillation electrode pads.

For instructions on placing the unit back into service, refer to “Preparing the Unit for Clinical Use” on page 2-5.

# Appendix A

# Specifications

---

This appendix describes the specifications for the AED Pro unit and contains the following sections:

- “Device Specifications” on page A-2
- “Battery Pack Specifications” on page A-6
- “Guidance and Manufacturer’s Declaration — Electromagnetic Compatibility” on page A-7
- “Rectilinear Biphasic Waveform Characteristics” on page A-11
- “Clinical Trial Results for the M Series Biphasic Waveform” on page A-14
- “ECG Analysis Algorithm Accuracy” on page A-17

## Device Specifications

<b>General</b>	
Size (height • width • length)	3 in • 9.24 in • 9.4 in 7.62 cm • 23.47 cm • 23.88 cm
Weight	5.19 lb. (2.35 kg) without battery pack 5.97 lb. (2.70 kg) with nonrechargeable battery pack
Power	Battery pack
Device classification	Class II and internally powered per EN 60601-1
Design standards	IEC 60601-2-4: 2010 (Third Edition) for use in conjunction with IEC 60601-1: 2005 + CORR. 1 (2006) + CORR. 2 (2007) + AM1 (2012) or IEC 60601-1: 2012
Patient safety	All patient connections are electrically isolated.
<b>Environmental</b>	
Temperature	Operating: 0°C to 50°C Storage and shipping: –30°C to 70°C
Humidity	10% to 95% relative humidity, noncondensing
Vibration	MIL-STD-810F, Integrity Test for Helicopters
Shock	IEC 60068-2-27; 100G
Altitude	Height: –300 to 15,000 ft; –91 to 4573 m Pressure: 768 to 429 mmHg; 1024 to 572 millibars
Particle and water ingress	IEC 60529, IP 55
Drop test	1.5 m per IEC 68-2-32
<b>Defibrillator</b>	
Waveform	ZOLL Rectilinear Biphasic waveform
Energy selection	Factory default: Adults: Automatic energy selection sequence 120J, 150J, 200J Pediatric: Automatic energy selection sequence 50J, 70J, 85J

Charge time	<ul style="list-style-type: none"> <li>• Less than 10 seconds with a new, fully charged battery pack.</li> <li>• Less than 10 seconds with a new, fully charged battery pack depleted by 15 maximum energy discharges.</li> <li>• Less than 20 seconds from initially switching power on in manual mode to readiness for maximum energy discharge with a new, fully charged battery pack depleted by 15 maximum energy discharges.</li> <li>• Less than 20 seconds from initiation of rhythm analysis in semiautomatic mode to readiness for discharge at maximum energy with a new, fully charged battery pack.</li> <li>• Less than 20 seconds from initiation of rhythm analysis in semiautomatic mode to readiness for discharge at maximum energy with a new, fully charged battery pack depleted by 15 maximum energy charges.</li> <li>• Less than 25 seconds from initially switching power on in semiautomatic mode to readiness for maximum energy discharge with a new, fully charged battery pack depleted by 15 maximum energy discharges (factory configuration).</li> </ul>
Charge hold time	Semiautomatic mode: 30 seconds Manual mode: 60 seconds
Energy display	Display screen shows selected energy level (manual mode only).
Charge controls	Semiautomatic mode: Automated Manual mode: Softkey
Defibrillation electrode pads	ZOLL single-use, pre-gelled electrode pads: <ul style="list-style-type: none"> <li>• CPR-D-padz (includes CPR sensor)</li> <li>• CPR Stat-padz (includes CPR sensor)</li> <li>• Adult Stat-padz II</li> <li>• Pediatric Pedi-padz II</li> </ul>
Built-in defibrillator self-test	Verifies proper charging and discharging of the defibrillator.
Defibrillation advisory	Evaluates electrode attachment and patient ECG to determine if defibrillation is needed.  Shockable arrhythmia: <ul style="list-style-type: none"> <li>• Ventricular fibrillation (VF) with amplitude greater than 100 <math>\mu</math>V</li> <li>• Wide-complex ventricular tachycardia (VT) Adult: greater than 150 beats per minute and QRS duration &gt;120 msec Pediatric: greater than 200 beats per minute and QRS duration &gt;90 msec</li> </ul>
Valid patient impedance range	10 $\Omega$ to 300 $\Omega$ $\pm$ 5 $\Omega$ or $\pm$ 10%, whichever is greater
<b>CPR Monitoring</b>	
Compression depth	0.75 to 3 inches $\pm$ 0.25 inches 1.9 to 7.6 cm $\pm$ 0.6 cm
Compression rate	50 to 150 compressions per minute
<b>ECG Monitoring</b>	
Input protection	Fully defibrillation-protected
Implanted pacemaker pulses detected	The AED Pro does not reject implanted pacemaker pulses.

Bandwidth	1.4 to 22 Hz with defibrillation electrode cable 1.4 to 22 Hz (default) with AED Pro ECG cable; 0.7 to 30 Hz as a configurable option
ECG lead	Lead II
ECG amplitude range	±5 mV
Heart rate range	30 to 300 beats per minute
Heart rate accuracy	±5 beats per minute
Heart rate resolution	1 beat per minute
Heart rate alert	<ul style="list-style-type: none"> <li>Configurable low heart rate limit in the range 30 to 100 beats per minute</li> <li>Off</li> </ul>
Heart rate alarm	Voice and text prompt indicates activated/deactivated status. Tachycardia: 250 bpm Bradycardia: 30 bpm - 100 bpm, user selectable
Tall T-wave rejection	≤ 9 mm (ECG scale at x1) ≤ 0.9 mV
Heart rate averaging	<p>The AED Pro averages the interval between the last 5 detected beats. On startup, the AED Pro averages the rate between detected beats once two beats are detected, until a full 5 beats have been received. The rate is updated every beat. After this condition is met, the meter is updated every beat with an average of the last 5 beats.</p> <p>If a period of time greater than 5 seconds elapses without a beat detected, the heart rate meter reports a rate of 0 bpm, which is repeated every 5 seconds.</p>
Accuracy and response time to irregular rhythm per EN 60601-2-27 2nd Ed.: 2005	<ul style="list-style-type: none"> <li>Ventricular Bigeminy (Figure A1) - 40 bpm</li> <li>Slow alternating ventricular bigeminy (Figure A2) - 55-65 bpm</li> <li>Rapid alternating ventricular bigeminy (Figure A3) - 59-60 bpm</li> <li>Bidirectional systoles (Figure A4) - 59-60 bpm</li> </ul>
Response time to change in heart rate	80 to 120 bpm: 4 seconds 80 to 40 bpm: 4 seconds
Time to alarm for tachycardia per EN 60601-2-27 2nd Ed.: 2005	<p>(Figure B1) 206 bpm (1 mV): 7.9 seconds 206 bpm (.5 mV): 8.7 seconds 206 bpm (2 mV): 8.2 seconds</p> <p>(Figure B2) 195 bpm (2 mV): 7.9 seconds 195 bpm (1 mV): 7.1 seconds 195 bpm (4 mV): 8.0 seconds</p>
ECG leads off sensing	A DC current of < 10 µA per lead wire is supplied to the patient.
Defibrillation electrodes leads off sensing	67 kHz square wave, <1 mA

<b>Data Recording and Storage</b>	
Type	Nonvolatile memory
Capacity	5.8 hours of ECG data and CPR data 20 minutes of audio recording and ECG data if Audio Recording Option is enabled
<b>Display Screen</b>	
Display type	Liquid crystal display (LCD) High resolution, 320 pixels by 240 pixels
Viewable area (height • width)	2.27 in • 3.02 in 5.76 cm • 7.68 cm
Sweep speed	25 mm/s ±5%
Viewing time	2.96 seconds (if CPR gauge displayed) 3.2 seconds (without CPR gauge)

## Battery Pack Specifications

<b>Rechargeable Sealed Lead Acid</b>	
Type	Sealed lead acid
Weight	1 kg 2.2 lb.
Nominal voltage	10 V
Recharge time	4 hours or less with: ZOLL Base PowerCharger 4x4 ZOLL Base PowerCharger 1x1 ZOLL SurePower Charger Station
Operating time	For a new, fully charged battery pack at 20°C: 170 defibrillator discharges at maximum energy (200 joules) or 6 hours of continuous monitoring.  The <i>CHANGE BATTERY</i> warning appears after 115 maximum-energy discharges.
Standby life	3 months before recharge or retest
<b>Disposable Sealed Lithium Manganese Dioxide</b>	
Type	Disposable sealed lithium manganese dioxide
Weight	0.4 kg 0.9 lb.
Nominal voltage	12 V
Operating time	For a new, fully charged battery pack at 20°C: 300 defibrillator discharges at maximum energy (200 joules) or 15 hours of continuous ECG monitoring.  The <i>CHANGE BATTERY</i> warning appears after 200 maximum-energy discharges.
Standby life	5 years
<b>Rechargeable Lithium Ion (SurePower Battery Pack)</b>	
Type	Rechargeable lithium ion
Weight	0.77 kg 1.7 lb.
Nominal voltage	10.8 V
Recharge time	4 hours or less with SurePower Charger Station
Operating time	For a new, fully charged battery pack at 20°C: 400 defibrillator discharges at maximum energy (200 joules) or 19 hours of continuous ECG monitoring.  The <i>CHANGE BATTERY</i> warning appears after 300 maximum-energy discharges.
Standby life	3 months before recharge or retest.



# Guidance and Manufacturer's Declaration — Electromagnetic Compatibility

**Table A-1. EMC Specifications**


Emissions Test	Compliance	Electromagnetic Environment – Guidance
RF emissions CISPR 11	Group 1	The ZOLL AED Pro unit uses RF energy for its internal function only. Therefore, its RF emissions are very low and are not likely to cause any interference in nearby electronic equipment.
RF emissions CISPR 11	Class B	The ZOLL AED Pro is suitable for use in all establishments, including domestic establishments and those directly connected to the public low voltage power supply network that supplies buildings for domestic purposes.
Harmonic emission IEC 61000-3-2	Not applicable	
Voltage fluctuations/ flicker emission IEC 61000-3-3		
Medical electrical equipment needs special precautions regarding EMC and needs to be installed and put into service according to EMC information provided in this document.		

## Electromagnetic Immunity Declaration (EID)

The ZOLL AED Pro device is intended for use in the electromagnetic environment specified below. Operation outside of this environment could result in the misinterpretation of the ECG rhythms or CPR signals, interference to the display or audio messages, or the inability to provide defibrillation therapy. The operator of the unit must ensure that it is used in this environment.

The ZOLL AED Pro defibrillator's essential performance is energy delivery, ECG rhythm analysis, ECG, and CPR feedback, as specified above on pages A-2 through A-6. The AED Pro defibrillator meets basic safety and essential performance when it is operated in the electromagnetic environment specified in the following tables.

Immunity Test	IEC 60601 Test Level	Compliance Level	Electromagnetic Environment – Guidance
Electrostatic discharge (ESD) IEC 61000-4-2	±8 kV contact  ±15 kV air	±8 kV contact  ±15 kV air	The relative humidity should be at least 5%.
Electrical fast transient/burst IEC 61000-4-4	±2 kV for power supply lines  ±1 kV for input/output lines	Not applicable  ±1 kV I/O	
Surge IEC 61000-4-5	±1 kV differential mode  ±2 kV for common mode	Not applicable  Not applicable	
Voltage dips, short interruptions, and voltage variations on power supply input lines IEC 61000-4-11	<5% $U_T$ (>95% dip in $U_T$ ) for 0.5 cycle  40% $U_T$ (60% dip in $U_T$ ) for 5 cycles  70% $U_T$ (30% dip in $U_T$ ) for 25 cycles  <5% $U_T$ (>95% dip in $U_T$ ) for 5 seconds  <b>Note:</b> $U_T$ is the AC mains voltage prior to application of the test level.	Not applicable  Not applicable  Not applicable  Not applicable	
Power frequency (50/60 Hz) magnetic field IEC 61000-4-8	30 A/m	30 A/m	Power frequency magnetic fields should be at levels characteristic of a typical location in a typical commercial or hospital environment.

Immunity Test	IEC 60601 Test Level	Compliance Level	Electromagnetic Environment – Guidance
<p>Conducted RF IEC 61000-4-6</p>	<p>3 Vrms 150 kHz to 80 MHz outside ISM bands<sup>a</sup></p> <p>10 Vrms 150 kHz to 80 MHz in ISM bands<sup>a</sup></p>	<p>3 Vrms</p> <p>10 Vrms</p>	<p>Portable and mobile RF communications equipment should be used no closer to any part of the AED Pro device, including cables, than the recommended separation distance calculated from the equation applicable to the frequency of the transmitter.</p> <p>Recommended separation distance (<i>d</i>) in meters<sup>b</sup>:</p> <p><math>d = 1.2 \sqrt{P}</math> outside ISM bands</p> <p><math>d = 1.2 \sqrt{P}</math> within ISM bands</p>
<p>Radiated RF IEC 61000-4-3</p>	<p>10 V/m 80 MHz to 2.7 GHz</p>	<p>10 V/m</p>	<p><math>d = 1.2 \sqrt{P}</math> 80 MHz to 800 MHz</p> <p><math>d = 2.3 \sqrt{P}</math> 800 MHz to 2.7 GHz</p> <p>where <i>P</i> is the maximum output power rating of the transmitter in watts (<i>W</i>) according to the transmitter manufacturer.</p> <p>Field strengths from fixed RF transmitters, as determined by an electromagnetic site survey<sup>c</sup>, should be less than the compliance level in each frequency range<sup>d</sup>.</p> <p>Interference may occur in the vicinity of equipment marked with the following symbol:</p> 
<p><b>Notes</b></p> <p>(1) At 80 MHz and 800 MHz, the higher frequency range applies.</p> <p>(2) These guidelines may not apply in all situations. Electromagnetic propagation is affected by absorption and reflection from structures, objects, and people.</p>			

- a. The ISM (industrial, scientific, and medical) bands between 150 kHz and 80 MHz are 6.765 MHz to 6.795 MHz; 13.553 MHz to 13.567 MHz; 26.957 MHz to 27.283 MHz; and 40.66 MHz to 40.70 MHz.
- b. The compliance levels in the ISM frequency bands between 150 kHz and 80 MHz and in the frequency range 80 MHz to 2.7 GHz are intended to decrease the likelihood that mobile or portable communications equipment could cause interference if it is inadvertently brought into patient areas. For this reason, an additional factor of 10/3 is used in calculating the recommended separation distance for transmitters in these frequency ranges.
- c. Field strengths from fixed transmitters, such as base stations for radio (cellular or cordless) telephones and land mobile radios, amateur radio, AM and FM radio broadcast and TV broadcast cannot be predicted theoretically with accuracy. To assess the electromagnetic environment due to fixed RF transmitters, an electromagnetic site survey should be considered. If the measured field strength in the location in which the AED Pro unit is used exceeds the applicable RF compliance level above, the AED Pro unit should be observed to verify normal operation. If abnormal performance is observed, additional measures may be necessary, such as reorienting or relocating the AED Pro unit.
- d. Over the frequency range 150 kHz to 80 MHz, field strengths should be less than 10 V/m.

### Recommended separation distances between portable and mobile RF communications equipment and the AED Pro unit

The AED Pro unit is intended for use in an environment in which radiated RF disturbances are controlled. The customer or operator can help prevent electromagnetic interference by maintaining a minimum distance between portable and mobile RF communications equipment (transmitters) and the AED Pro unit as recommended below, according to the maximum output power of the communications equipment.

Rated maximum output power of transmitter in watts (W)	Separation distance in meters (m) according to frequency of transmitter			
	150 kHz to 80 MHz outside ISM bands	150 kHz to 80 MHz in ISM bands	80 MHz to 800 MHz	800 MHz to 2.7 GHz
	$d = 1.2 \sqrt{P}$	$d = 1.2 \sqrt{P}$	$d = 1.2 \sqrt{P}$	$d = 2.3 \sqrt{P}$
0.01	0.12	0.12	0.12	0.23
0.1	0.38	0.38	0.38	0.73
1	1.2	1.2	1.2	2.3
10	3.8	3.8	3.8	7.3
100	12	12	12	23

For transmitters rated at a maximum output power not listed above, the recommended separation distance  $d$  in meters can be determined using the equation applicable to the frequency of the transmitter, where  $P$  is the maximum output power rating of the transmitter in watts according to the transmitter manufacturer.

#### Notes

- (1) At 80 MHz and 800 MHz, the separation distance for the higher frequency range applies.
- (2) The ISM (industrial, scientific, and medical) bands between 150 kHz and 80 MHz are 6.765 MHz to 6.795 MHz; 13.553 MHz to 13.567 MHz; 26.957 MHz to 27.283 MHz; and 40.66 MHz to 40.70 MHz.
- (3) An additional factor of 10/3 is used in calculating the recommended separation distance for transmitters in the ISM frequency bands between 150 kHz and 80 MHz and in the frequency range 80 MHz to 2.7 GHz to decrease the likelihood that mobile or portable communications equipment could cause interference if it is inadvertently brought into patient areas.
- (4) These guidelines may not apply in all situations. Electromagnetic propagation is affected by absorption and reflection from structures, objects, and people.

## Rectilinear Biphasic Waveform Characteristics

The following table shows the characteristics of the Rectilinear Biphasic waveform when discharged into 25 ohm, 50 ohm, 100 ohm, and 125 ohm loads at the maximum energy setting of 200 joules.

**Table A-2. Rectilinear Biphasic Waveform Characteristics**

	200 J discharged into			
	25Ω	50Ω	100Ω	125Ω
<b>First phase</b>				
Maximum initial current	32 A	26 A	21 A	17 A
Average current	28 A	22 A	16 A	13 A
Duration	6 ms	6 ms	6 ms	6 ms
<b>Interphase duration</b> (between first and second phases)				
	200 μs	200 μs	200 μs	200 μs
<b>Second phase</b>				
Initial current	33 A	19 A	12 A	11 A
Average current	21 A	14 A	11 A	10 A
Duration	4 ms	4 ms	4 ms	4 ms

**Table A-3. Delivered Energy at Each Defibrillator Setting into a Range of Loads**

Load	Selected Energy					
	50 J	70 J	85 J	120 J	150 J	200 J
25Ω	40 J	61 J	66 J	95 J	111 J	146 J
50Ω	51 J	80 J	85 J	124 J	144 J	183 J
75Ω	64 J	89 J	111 J	148 J	172 J	204 J
100Ω	62 J	86 J	108 J	147 J	171 J	201 J
125Ω	63 J	89 J	110 J	137 J	160 J	184 J
150Ω	67 J	93 J	116 J	127 J	148 J	168 J
175Ω	61 J	86 J	107 J	119 J	138 J	155 J
Accuracy	±15%	±15%	±15%	±15%	±15%	±15%

The AED Pro Rectilinear Biphasic waveform employs the same first and second phase timing, similar first and second phase currents/voltages, and essentially the same mechanisms for controlling defibrillation waveshape as the ZOLL M Series®. The ZOLL M Series and AED Pro defibrillation waveforms are considered substantially equivalent.

Figures A-1 through A-6 show the Rectilinear Biphasic waveforms that are produced when the AED Pro defibrillator is discharged into loads of 25, 50, 75, 100, 125, 150, and 175 ohms at each energy setting (200, 150, 120, 85, 70, and 50 joules).

The vertical axis shows the current in amperes (A); the horizontal axis shows the duration in milliseconds (ms).

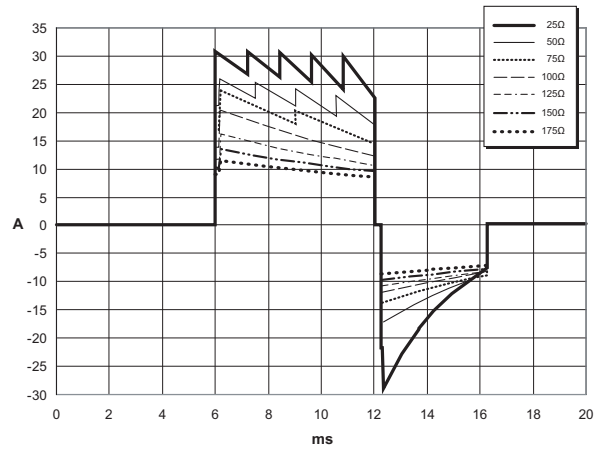


Figure A-1. Rectilinear Biphasic Waveforms at 200 Joules

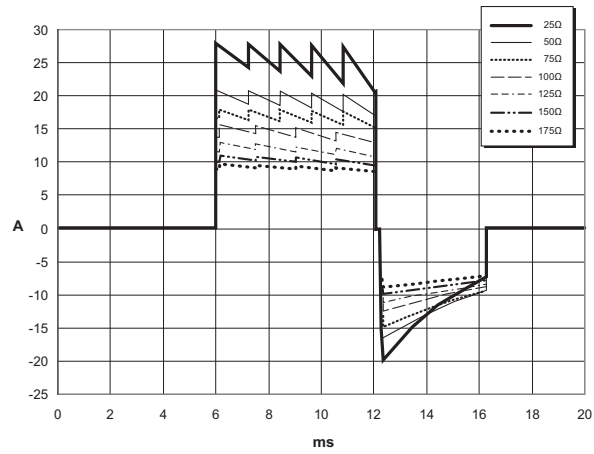


Figure A-2. Rectilinear Biphasic Waveforms at 150 Joules

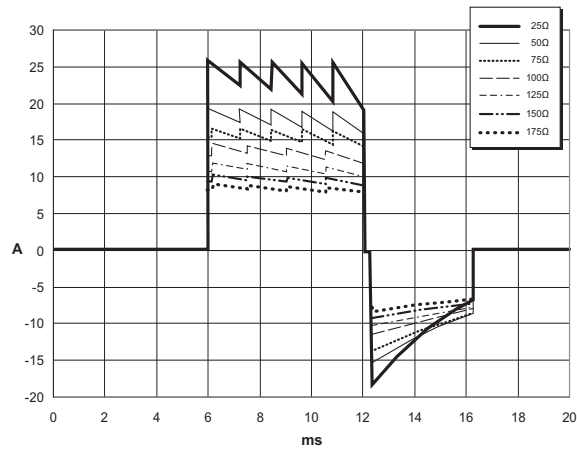


Figure A-3. Rectilinear Biphasic Waveforms at 120 Joules

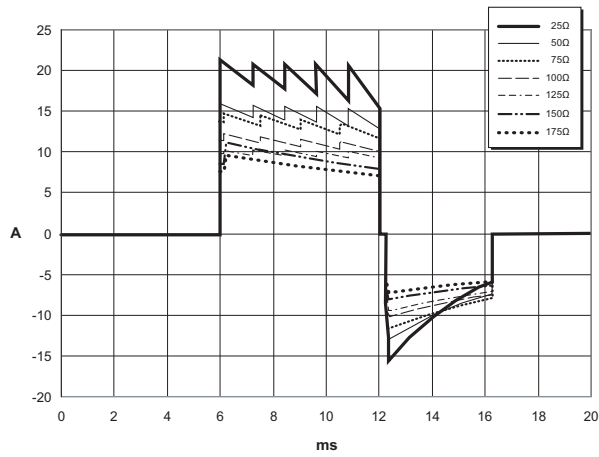


Figure A-4. Rectilinear Biphasic Waveforms at 85 Joules

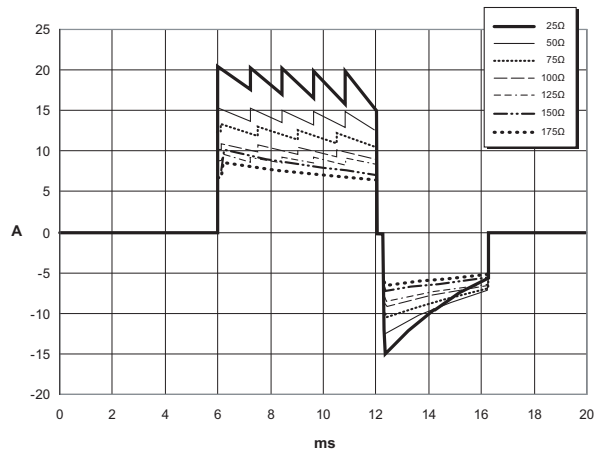


Figure A-5. Rectilinear Biphasic Waveforms at 70 Joules

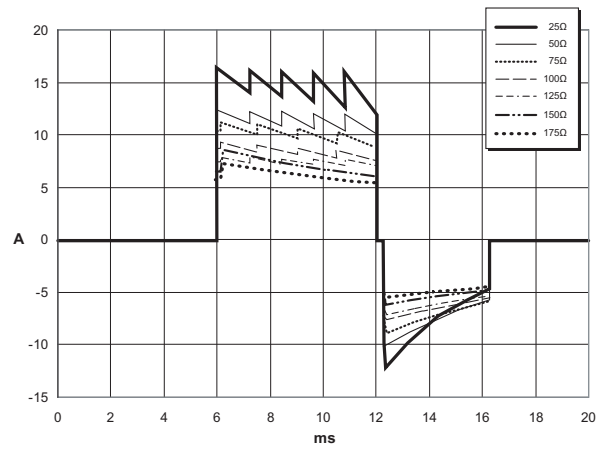


Figure A-6. Rectilinear Biphasic Waveforms at 50 Joules

## Clinical Trial Results for the M Series Biphasic Waveform

The efficacy of the ZOLL Rectilinear Biphasic waveform has been clinically verified during a study of defibrillation of Ventricular Fibrillation (VF) and Ventricular Tachycardia (VT). A feasibility study was performed initially for defibrillation of VF/VT (n=20) on two separate groups of patients to ensure waveform safety and energy selection. Subsequently, a separate, multicenter, randomized clinical trial was performed to verify the waveform's efficacy. A description of this study is provided below. The study was performed using ZOLL defibrillation systems consisting of ZOLL defibrillators, the ZOLL Rectilinear Biphasic waveform, and ZOLL defibrillation pads.

### Randomized Multicenter Clinical Trial for Defibrillation of Ventricular Fibrillation (VF) and Ventricular Tachycardia (VT)

**Overview:** The defibrillation efficacy of the ZOLL Rectilinear Biphasic waveform was compared to a monophasic damped sine waveform in a prospective, randomized, multicenter study of patients undergoing ventricular defibrillation for VF/VT during electrophysiological studies, ICD implants, and test. A total of 194 patients were enrolled in the study. Ten patients who did not satisfy all protocol criteria were excluded from the analysis, leaving a study population of 184.

**Objectives:** The primary goal of this study was to compare the first shock efficacy of the 120 J Rectilinear Biphasic waveform with a 200 J monophasic waveform. The secondary goal was to compare all shock (three consecutive 120, 150, and 170 joules) efficacy of the Rectilinear Biphasic waveform with that of a monophasic waveform (three consecutive 200, 300, and 360 joules). A significance level of  $p=0.05$  or less was considered statistically significant using Fischer's Exact test. Also, differences between the two waveforms were considered statistically significant when the customary 95% or AHA-recommended 90%<sup>1</sup> confidence interval between the two waveforms was greater than 0%.

**Results:** The study population of 184 patients had a mean age of  $63\pm 14$  years. Of these, 143 patients were male. 98 patients were in the biphasic group (ventricular fibrillation/flutter, n=80; ventricular tachycardia, n=18) and 86 patients were in the monophasic group (ventricular fibrillation/flutter, n=76; ventricular tachycardia, n=10). There were no adverse events or injuries related to the study.

The first shock, first induction efficacy of biphasic shocks at 120 J was 99% versus 93% for monophasic shocks at 200 J ( $p=0.0517$ , 95% confidence interval of the difference of  $-2.7\%$  to  $16.5\%$  and 90% confidence interval of the difference of  $-1.01\%$  to  $15.3\%$ ).

	Monophasic	Biphasic
First shock efficacy	93%	99%
p-value	0.0517	
95% confidence interval	$-2.7\%$ to $16.5\%$	
90% confidence interval	$-1.01\%$ to $15.3\%$	

1. Kerber RE, et al., "Automated External Defibrillators for Public Access Defibrillation: Recommendations for Specifying and Reporting Arrhythmia Analysis Algorithm Performance, Incorporating New Waveforms, and Enhancing Safety," *Circ J Am Heart Assoc.* 1997;95:1677-1682.

"... the task force suggests that to demonstrate superiority of an alternative waveform over standard waveforms, the upper boundary of the 90% confidence interval of the difference between standard and alternative waveforms must be  $<0\%$  (ie, alternative is greater than standard)."



Successful defibrillation with Rectilinear Biphasic shocks was achieved with 58% less delivered current than with monophasic shocks (14±1 amperes versus 33±7 amperes, p=0.0001).

The difference in efficacy between the Rectilinear Biphasic and the monophasic shocks was greater in patients with high transthoracic impedance (greater than 90 ohms). The first shock, first induction efficacy of biphasic shocks was 100% versus 63% for monophasic shocks for patients with high impedance (p=0.02, 95% confidence interval of the difference of -0.0217% to 0.759% and 90% confidence interval of the difference of 0.037% to 0.706%).

	Monophasic	Biphasic
First shock efficacy (high impedance patients)	63%	100%
p-value	0.02	
95% confidence interval	-0.0217% to 0.759%	
90% confidence interval	0.037% to 0.706%	

A single patient required a second biphasic shock at 150 joules to achieve 100% efficacy versus six patients for whom monophasic shocks of up to 360 joules were required for 100% total defibrillation efficacy.

**Conclusion:** The data demonstrate the equivalent efficacy of low energy Rectilinear Biphasic shocks compared to standard high energy monophasic shocks for transthoracic defibrillation for all patients at the 95% confidence level. The data also demonstrate the superior efficacy of low energy Rectilinear Biphasic shocks compared to standard high energy monophasic shocks in patients with high transthoracic impedance at the 90% confidence level. There were no unsafe outcomes or adverse events due to the use of Rectilinear Biphasic waveform.

## Pre-Clinical Study

To support pediatric usage for the ZOLL Rectilinear Bi-Phasic Waveform, ZOLL submitted pre-clinical data to the FDA as part of a 510(k) submission for its AED Pro device (cleared by the FDA under K041892). The protocol for this pre-clinical study, along with a summary of the results, have been submitted to FDA under AED Pro PMA application (P160022). A summary of this study is presented below.

To demonstrate the safety and efficacy of our Rectilinear Bi-Phasic Waveform when used to treat pediatric VF patients, ZOLL conducted a study using a porcine model of pediatric patients less than 8 years of age. This study included 18 piglets in three (3) size groups (two (2) animals weighing 4 kg, eight (8) animals weighing 8 kg, and eight (8) animals weighing 16 kg) and compared the defibrillation dose/response curves observed using proposed biphasic waveform with those observed using a standard monophasic damped sine wave (DSW) defibrillator to treat short duration (~ 30 seconds) ventricular fibrillation. The study demonstrated that the biphasic waveform defibrillates pediatric pigs with equal efficacy but lower energy (on a Joules/kg basis) than traditional monophasic damped sine wave defibrillators. To confirm the safety of the proposed biphasic waveform in pediatric patients, we studied and compared measures of cardiac function before and after both DSW and Rectilinear Bi-Phasic Waveform defibrillation shocks over a range of relevant energies. The study demonstrated that the biphasic defibrillation produced equivalent or milder disturbances of cardiac function when compared to traditional DSW defibrillation at the same energies.

Another animal study compared the ZOLL rectilinear biphasic (RLB) waveform to a biphasic truncated exponential (BTE) waveform. The study, using an immature porcine model (n=21), was a prospective, randomized, controlled design to determine the dose response curves for the RLB and BTE defibrillation waveforms. A weight range from 4 to 24 Kg for an animal represented a pediatric patient. The weight ranging from 4 to 8 Kg represented a patient less than 1 year old (infant subgroup), and the weight range from 16 to 24 Kg represented a pediatric patient between the ages of 2 and 8 years (young children subgroup).

The ZOLL RLB waveform demonstrated a superior capability to defibrillate a porcine pediatric model with < 90% of the D50 energy required for a BTE waveform (D50 energy: RLB 25.6 ± 15.7 J, BTE 28.6 ± 17.0 J, P = 0.0232; D90 energy: RLB 32.6 ± 19.1 J, BTE 37.8 ± 23.2 J, P = 0.0228).

The ECG ST segment changes (mV) and LV pressure changes (dP/dt) following a defibrillation shock were compared between the RLB waveform to the BTE waveform. The RLB waveform had an average ST segment increase above baseline of 0.138 ± 0.136 mV (N=401 shocks) compared to the BTE waveform's average increase of 0.146 ± 0.148 mV (N=396 shocks). The RLB waveform had an average dP/dt at the 40 mmHg threshold (the point in time when an animal's blood pressure exceeded 40 mmHg spontaneously) of 1987 ± 411 mmHg/s (N=496 shocks) compared to the BTE waveform's average dP/dt of 2034 ± 425 mmHg/s (N=496 shocks).

## Published Clinical Data

Additional clinical data was included with PMA application P160022 to support out-of-hospital use of ZOLL's Rectilinear Bi-Phasic defibrillation waveform. The data reported by Hess et al in Resuscitation (82 (2011) 685–689) is considered sufficient to support ZOLL's defibrillation waveform in the out-of-hospital environment. The resulting clinical paper, "Performance of a rectilinear biphasic waveform in defibrillation of presenting and recurrent ventricular fibrillation: A prospective multicenter study," was included with PMA application P160015. A summary of the study is presented below:

**Objectives:** The study tested the hypothesis that shock success differs with initial and recurrent episodes of ventricular fibrillation (VF).

**Methods:** From September 2008 to March 2010 out-of-hospital cardiac arrest patients with VF as the initial rhythm at 9 study sites were defibrillated by paramedics using a rectilinear biphasic waveform. Shock success was defined as termination of VF within 5 s post-shock. The study used generalized estimating equation (GEE) analysis to assess the association between shock type (initial versus defibrillation) and shock success.

**Results:** Ninety-four patients presented in VF. Mean age was 65.4 years, 78.7% were male, and 80.9% were bystander-witnessed. VF recurred in 75 (79.8%). There were 338 shocks delivered for initial (n = 90) or recurrent (n = 248) VF available for analysis. Initial shocks terminated VF in 79/90 (87.8%) and subsequent shocks in 209/248 (84.3%). GEE odds ratio (OR) for shock type was 1.37 (95% CI 0.68–2.74). After adjusting for potential confounders, the OR for shock type remained insignificant (1.33, 95% CI 0.60–2.53). The study observed no significant difference in ROSC (54.7% versus 52.6%, absolute difference 2.1%, p = 0.87) or neurologically intact survival to hospital discharge (21.9% versus 33.3%, absolute difference 11.4%, p = 0.31) between those with and without VF recurrence.

**Conclusions:** Presenting VF was terminated with one shock in 87.8% of cases. The study observed no significant difference in the frequency of shock success between initial versus recurrent VF. VF recurred in the majority of patients and did not adversely affect shock success, ROSC, or survival.

## ECG Analysis Algorithm Accuracy

Sensitivity and specificity are expressions of ECG analysis algorithm performance when compared to ECG interpretation by a clinician or expert. Sensitivity refers to the algorithm's ability to correctly identify shockable rhythms (as a percentage of the total number of shockable rhythms). Specificity refers to the algorithm's ability to correctly identify nonshockable rhythms (as a percentage of the total number of nonshockable rhythms).

The data in Table A-4 and Table A-5 summarize the accuracy of the ECG analysis algorithm as tested against the ZOLL ECG rhythm database.

The algorithm sequence takes approximately 9 seconds and proceeds as follows:

- Divides the ECG rhythm into 3-second segments
- Filters and measures noise, artifact, and baseline wander
- Measures baseline content (“waviness” at the correct frequencies – frequency domain analysis) of signal
- Measures QRS rate, width, and variability
- Measures amplitude and temporal regularity (autocorrelation) of peaks and troughs
- Determines if multiple 3-second segments are shockable and then prompts the operator to treat the patient

**Table A-4. Clinical Performance Results (Adult Patients)**

Rhythms	Sample Size	Performance Goals	Observed Performance	90% One-sided Lower Confidence Limit
<b>Shockable</b>	<b>616</b>	<b>Sensitivity</b>		
Coarse VF	536	>90%	100%	99.44%
Rapid VT	80	>75%	98.75%	99.21%
<b>Nonshockable</b>	<b>3144</b>	<b>Specificity</b>		
NSR	2210	>99%	99.95%	99.79%
AF, SB, SVT, heart block, idioventricular, PVCs	819	>95%	100%	99.63%
Asystole	115	>95%	100%	97.43%
<b>Intermediate</b>	<b>97</b>			
Fine VF	69	Report only	94.20%	87.22%
Other VT	28	Report only	100%	89.85%

**Table A-5. Clinical Performance Results (Pediatric Patients)**

Rhythms	Sample Size (9 second records)	Performance Goals	Observed Performance	90% One-sided Lower Confidence Limit
<b>Shockable (128 patients)</b>		<b>Sensitivity</b>		
Coarse VF	49	>90%	100% (42/42)	93.12%
Rapid VT	79	>75%	100% (77/82)	96.28%
<b>Nonshockable (155 patients)</b>		<b>Specificity</b>		
NSR	208	>99%	100% (208/208)	98.6%
AF, SB, SVT <sup>a</sup> , heart block, idioventricular, PVCs	348	>95%	99.43% (346/348)	98.20%
Asystole	29	>95%	100% (29/29)	90.19%
<b>Intermediate (16 patients)</b>				
Fine VF	0	Report only	—	—
Other VT	44	Report only	81.82% (36/40)	89.58%

a. 161 of the 348 abnormal rhythm records were SVT (72 patients). The SVT heart rates ranged from 152 to 302 beats per minute.

Arrhythmia performance is reported according to the article, Kerber RE, Becker LB, Bourland JD, Cummins RO, Hallstrom AP, Michos MB, Nichol G, Ornato JP, Thies WH, White RD, Zuckerman BD. “Automated External Defibrillators for Public Access Defibrillation: Recommendations for Specifying and Reporting Arrhythmia Analysis Algorithm Performance, Incorporating New Waveforms, and Enhancing Safety,” *Circ J Am Heart Assoc.* 1997;95:1677-1682.

## References

Young KD, Lewis RJ. “What is confidence? Part 2: Detailed definition and determination of confidence intervals”. *Ann Emerg Med.* September 1997;30:311-318.

Beyer WH. Percentage Points, F-Distribution Table. *CRC Standard Mathematical Tables.* 28<sup>th</sup> ed. Boca Raton, Fla: CRC Press; 1981:573.

# Appendix B

## Rechargeable Battery Packs

---

This appendix provides information about using rechargeable battery packs with the AED Pro unit and contains the following sections:

- “Managing Rechargeable Battery Packs” on page B-2
- “Recharging and Testing Battery Packs” on page B-2
- “Achieving Optimal Performance with Rechargeable Batteries” on page B-3

For specifications, refer to “Battery Pack Specifications” on page A-6.

## Managing Rechargeable Battery Packs

Rechargeable battery packs require a full recharge after each use. Avoid using a battery pack that is not fully recharged.

---

**WARNING! Regular use of a partially charged battery pack without a full recharge between uses results in permanently reduced capacity and early failure of the battery pack.**

---

Many factors contribute to the loss of battery capacity, including the frequency of use, the number of battery packs available for operations, and the pattern of discharging and recharging battery packs. Because of this, ZOLL recommends that operators schedule a preventive routine for replacing and discarding used battery packs. Base your replacement schedule for rechargeable battery packs on anticipated use patterns, battery pack testing results, and experience with the device in actual operation.

When stored and not in use, a battery pack can lose 2% to 3% of its energy per month.

ZOLL recommends purchasing new batteries every eighteen months or sooner.

## Recharging and Testing Battery Packs

ZOLL battery packs are designed to be charged in ZOLL chargers. ZOLL recommends that you always have a ZOLL auxiliary battery charger available for charging spare battery packs and for routine testing of battery packs.

---

**WARNING! Test battery packs regularly. A battery that does not pass its test might shut down unexpectedly.**

---

For information on using battery chargers, refer to the ZOLL Base PowerCharger manuals listed in “Related Manuals” on page vi.

## Achieving Optimal Performance with Rechargeable Batteries

To ensure the longest life from rechargeable battery packs, follow these general practices:

**DO carry a fully charged spare battery pack at all times.**

**DO charge battery packs completely.**

Whenever a battery pack exchange is required, install a fully charged battery pack.

Use of partially charged battery packs might result in very short run time and unexpected shutdown.

If you use a partially charged battery pack, fully charge that battery pack before using it again. Repeated use after partial charging quickly diminishes the battery pack's capacity, thereby shortening its life.

If you must frequently use partially charged battery packs, your organization should assess whether enough battery packs are available to fully support typical rescue activity.

**DO implement a means of indicating the charge status of battery packs.**

It is important to visually distinguish battery packs that are charged from those that are not. Establish a system for visually indicating whether a battery pack requires charging or is charged and ready for use. ZOLL can provide battery pack status labels for this purpose, or you can use labels or methods of your own.

**DO change the battery pack as soon as the message *CHANGE BATTERY* appears.**

The battery warning ultimately leads to shutdown of the unit. As a battery ages, its remaining operating time between the warning and shutdown progressively diminishes. Older battery packs might provide very little run time after the warning and might fail unexpectedly. Always replace a battery with a fully charged battery as soon as the battery warning appears.

**DO test rechargeable battery packs regularly.**

Your organization must determine and implement an appropriate testing schedule for rechargeable battery packs. Conformance to this schedule is crucial for identifying battery packs that have reached end-of-life and should be removed from use. Battery packs subjected to repeated short discharge-and-charge cycles might lose capacity quickly, and so should be tested more frequently.

**DO exchange battery packs regularly.**

Exchange battery packs once every shift or once every day, depending on their use.

**DO exercise or test battery packs every 90 days (or sooner as they age).**

**DO NOT store battery packs in a discharged or depleted state.**

When you remove a rechargeable battery from the unit, immediately place it in a charger or test well. Idle battery packs lose some of their charge and might suffer damage to charge capacity if left in a discharged state.

**DO NOT assume that a shift check of the unit verifies adequate battery pack run time.**

Test the unit daily to verify its readiness for use. This test, however, does not verify adequate charge state or capacity of the battery pack and might leave the unit with inadequate run time.

If the message *CHANGE BATTERY* appears during testing, replace the battery pack immediately. If the removed battery pack is rechargeable, recharge it immediately.

**DO NOT charge battery packs at temperature extremes.**

Charge battery packs at or near normal room temperature (15°C to 35°C or 59°F to 95°F).

**DO NOT remove a partially charged battery pack from the battery charger.**

Always fully charge a battery pack before returning it to use. If you must use a partially charged battery pack, be sure to fully charge the pack before its next use.



# Appendix C

## Configurable Settings

---

This appendix describes the configurable settings for the AED Pro unit. To configure the AED Pro device, use ZOLL Administration Software (ZAS) installed on a Windows-based personal computer. After you establish an IrDA connection between the computer and the AED Pro unit, you can modify the configuration settings on the unit or load a saved configuration and send it to the unit.

## Descriptions of AED Pro Configurable Settings

Configurable Option	Possible Values
<b>General Settings</b>	
<p><i>Self-test Interval</i></p> <p>Sets the period of time between automated self-tests in standby state.</p>	<ul style="list-style-type: none"> <li>• 1 day — default</li> <li>• 2 days</li> <li>• 3 days</li> <li>• 4 days</li> <li>• 5 days</li> <li>• 6 days</li> <li>• 7 days</li> </ul>
<p><i>Line Frequency</i></p> <p>Selects the AC power frequency to be filtered during ECG monitoring.</p>	<ul style="list-style-type: none"> <li>• 60 Hz — default</li> <li>• 50 Hz</li> </ul>
<p><i>Power Down Delay</i></p> <p>Sets the time interval after which the unit powers off if no patient connection is detected.</p>	<ul style="list-style-type: none"> <li>• 5 minutes</li> <li>• 10 minutes — default</li> <li>• 15 minutes</li> <li>• 20 minutes</li> <li>• 30 minutes</li> </ul>
<p><i>Audio Volume</i></p> <p>Sets the volume level for voice messages and tones.</p>	<ul style="list-style-type: none"> <li>• High — default</li> <li>• Medium</li> <li>• Low</li> </ul>
<p><i>Number of Patient Records</i></p> <p>Sets the number of patients for whom information will be stored in nonvolatile flash memory.</p>	<ul style="list-style-type: none"> <li>• 1</li> <li>• 2</li> <li>• 3</li> <li>• 4 — default</li> </ul>
<p><i>Audio Recording Enabled</i></p> <p>Enables the use of the Audio Recording Option (requires the installation of an internal microphone when the AED Pro unit is manufactured).</p> <p><b>Note:</b> You must set the Number of Patient Records to 1 before you can enable the Audio Recording Option.</p>	<ul style="list-style-type: none"> <li>• Disabled — default</li> <li>• Enabled</li> </ul>
<p><i>Monthly Test</i></p> <p>When checked (<b>On</b>), the unit performs a monthly full-energy self-test (120 joules).</p>	<ul style="list-style-type: none"> <li>• On — default</li> <li>• Off</li> </ul>
<p><i>Daylight Savings</i></p> <p>Allows the AED Pro's 24-hour clock to automatically adjust for Daylight Savings Time.</p>	<ul style="list-style-type: none"> <li>• Manual — default</li> <li>• US Pre-2007</li> <li>• US</li> <li>• EU</li> <li>• EU Southern Hemisphere</li> </ul>
<p><i>Number of Shocks</i></p> <p>Sets the number of shocks in the shock sequence to 1, 2, or 3 shocks.</p>	<ul style="list-style-type: none"> <li>• 1 Shock — default</li> <li>• 2 Shocks</li> <li>• 3 Shocks</li> </ul>

Configurable Option	Possible Values
<b>Shock Energy Level and Charging</b>	
<p><i>Adult First Shock Energy</i></p> <p>Sets the energy level in joules for the first shock for an adult patient.</p>	<ul style="list-style-type: none"> <li>• 120 J — default</li> <li>• 150 J</li> <li>• 200 J</li> </ul>
<p><i>Adult Second Shock Energy</i></p> <p><b>Note:</b> This value cannot be less than the value selected for the first adult shock.</p>	<ul style="list-style-type: none"> <li>• 120 J</li> <li>• 150 J — default</li> <li>• 200 J</li> </ul>
<p><i>Adult Third Shock Energy</i></p> <p><b>Note:</b> This value cannot be less than the value selected for the second adult shock.</p>	<ul style="list-style-type: none"> <li>• 120 J</li> <li>• 150 J</li> <li>• 200 J — default</li> </ul>
<p><i>Pediatric First Shock Energy</i></p> <p>Sets the energy level in joules for the first shock for a pediatric patient.</p>	<ul style="list-style-type: none"> <li>• 50 J — default</li> <li>• 70 J</li> <li>• 85 J</li> </ul>
<p><i>Pediatric Second Shock Energy</i></p> <p><b>Note:</b> This value cannot be less than the value selected for the first pediatric shock.</p>	<ul style="list-style-type: none"> <li>• 50 J</li> <li>• 70 J — default</li> <li>• 85 J</li> </ul>
<p><i>Pediatric Third Shock Energy</i></p> <p><b>Note:</b> This value cannot be less than the value selected for the second pediatric shock.</p>	<ul style="list-style-type: none"> <li>• 50 J</li> <li>• 70 J</li> <li>• 85 J — default</li> </ul>
<p><i>Enable Lay Rescuer</i></p> <p>When this option is checked (<b>On</b>), the unit issues the following voice and text prompts after completion of the power-on self-test and entry into clinical mode:</p> <p style="text-align: center;"><i>STAY CALM CALL FOR HELP</i></p>	<ul style="list-style-type: none"> <li>• <b>Off</b> — default</li> <li>• <b>On</b></li> </ul>
<p><i>Jump to Analysis</i></p> <p>When this option is checked (<b>On</b>), the unit immediately begins ECG analysis when pads are attached to the patient, except during CPR periods.</p> <p><b>Note:</b> The Start with CPR option, if also checked (<b>On</b>), overrides this setting.</p>	<ul style="list-style-type: none"> <li>• <b>On</b> — default</li> <li>• <b>Off</b></li> </ul>
<p><i>Unit OK</i></p> <p>When this option is checked (<b>On</b>), the unit issues the message <i>Unit OK</i> after a successful power-on self-test.</p>	<ul style="list-style-type: none"> <li>• <b>On</b></li> <li>• <b>Off</b> — default</li> </ul>
<b>Clinical Protocol Voice Prompts</b>	
<p><i>Breathing</i></p> <p>Allows you to select a check breathing prompt, based on the guidelines you want to follow.</p> <p>When disabled (<b>Off</b>), these prompts are not issued.</p>	<ul style="list-style-type: none"> <li>• <b>OFF</b> — default</li> <li>• <b>Open Airway, Check Breathing, Give Two Breaths</b></li> <li>• <b>Open Airway, Check Breathing</b></li> <li>• <b>Give Two Breaths</b></li> </ul>

Configurable Option	Possible Values
<p><i>Breathing Prompt Delay</i> Sets the period over which the unit issues the check breathing prompts.</p>	<ul style="list-style-type: none"> <li>• 2 seconds</li> <li>• 4 seconds</li> <li>• 6 seconds — default</li> <li>• 9 seconds</li> <li>• 15 seconds</li> <li>• 20 seconds</li> </ul>
<p><i>Responsiveness/Patient</i> Selects the wording for this prompt.</p>	<ul style="list-style-type: none"> <li>• OFF — default</li> <li>• <b>Check Responsiveness</b></li> <li>• <b>Check Patient</b></li> </ul>
<p><i>Responsiveness/Patient Prompt Delay</i> Sets the duration before the next prompt or disables this prompt.</p>	<ul style="list-style-type: none"> <li>• 2 seconds</li> <li>• 4 seconds — default</li> <li>• 6 seconds</li> <li>• 8 seconds</li> </ul>
<p><i>Circulation/Pulse</i> Selects the wording for this and related prompts.</p>	<ul style="list-style-type: none"> <li>• OFF — default</li> <li>• <b>Check Circulation</b></li> <li>• <b>Check Pulse</b></li> </ul>
<p><i>Circulation/Pulse Prompt Delay</i> Sets the duration before the next prompt or disables this prompt.</p>	<ul style="list-style-type: none"> <li>• 2 seconds</li> <li>• 5 seconds</li> <li>• 7 seconds</li> <li>• 10 seconds — default</li> <li>• 15 seconds</li> <li>• 20 seconds</li> </ul>
<p><i>Press Treatment/Shock</i> Selects the wording for this and related prompts.</p>	<ul style="list-style-type: none"> <li>• <b>Press Flashing Treatment Button</b></li> <li>• <b>Press Flashing Shock Button</b> — default</li> </ul>
<p><b>CPR</b></p>	
<p><i>CPR Monitoring</i> When this option is checked (<b>On</b>) and CPR-D-padz or CPR Stat-padz are attached, the unit performs CPR monitoring and prompts the rescuer.</p>	<ul style="list-style-type: none"> <li>• <b>On</b> — default</li> <li>• <b>Off</b></li> </ul>
<p><i>No-Shock CPR Period</i> Sets the duration of the CPR period following a no-shock result for the first analysis in a stack.  When you select <b>Extended</b>, the device remains in the CPR state indefinitely and displays the <b>ANALYZE</b> softkey. You must press the <b>ANALYZE</b> softkey to move to analysis.</p>	<ul style="list-style-type: none"> <li>• 30 seconds</li> <li>• 60 seconds</li> <li>• 90 seconds</li> <li>• 120 seconds — default</li> <li>• 150 seconds</li> <li>• 180 seconds</li> <li>• <b>Extended</b></li> </ul>
<p><i>Cycle through CPR</i> When this option is checked (<b>On</b>) and pads are detached from the patient for more than one and one-half minutes, the unit prompts the rescuer to perform CPR.</p>	<ul style="list-style-type: none"> <li>• <b>On</b> — default</li> <li>• <b>Off</b></li> </ul>

Configurable Option	Possible Values
<p><i>Post-Shock CPR Period</i></p> <p>Sets the duration of the CPR period following the delivery of one or more shocks.</p> <p>When you select <b>Extended</b>, the device remains in the CPR state indefinitely and displays the <b>ANALYZE</b> softkey. You must press the <b>ANALYZE</b> softkey to move to analysis.</p>	<ul style="list-style-type: none"> <li>• <b>30 seconds</b></li> <li>• <b>60 seconds</b></li> <li>• <b>90 seconds</b></li> <li>• <b>120 seconds</b> — default</li> <li>• <b>150 seconds</b></li> <li>• <b>180 seconds</b></li> <li>• <b>Extended</b></li> </ul>
<p><i>Start with CPR (Semiautomatic Mode only)</i></p> <p>When this option is checked (<b>On</b>), before beginning ECG analysis, the unit prompts the rescuer to check the patient's pulse and perform a period of CPR if no pulse is detected.</p>	<ul style="list-style-type: none"> <li>• <b>On</b></li> <li>• <b>Off</b> — default</li> </ul>
<p><i>Start with CPR Period</i></p> <p>Sets the duration of the CPR period associated with the <i>Start with CPR</i> option.</p> <p>When you select <b>Extended</b>, the device remains in the CPR state indefinitely and displays the <b>ANALYZE</b> softkey. You must press the <b>ANALYZE</b> softkey to move to analysis</p>	<ul style="list-style-type: none"> <li>• <b>30 seconds</b></li> <li>• <b>60 seconds</b></li> <li>• <b>90 seconds</b></li> <li>• <b>120 seconds</b> — default</li> <li>• <b>150 seconds</b></li> <li>• <b>180 seconds</b></li> <li>• <b>Extended</b></li> </ul>
<p><i>Analyze Key</i></p> <p>Enables or disables the <b>ANALYZE</b> softkey during the Post Shock and Post No Shock CPR periods. If the <b>ANALYZE</b> softkey is enabled, it appears during both the Post Shock and Post No Shock CPR periods.</p>	<ul style="list-style-type: none"> <li>• <b>On</b></li> <li>• <b>Off</b> — default</li> </ul>
<p><i>Fully Release</i></p> <p>When checked (<b>On</b>), this text prompt reminds the rescuer to lift the hands off the chest during CPR to allow full recoil.</p>	<ul style="list-style-type: none"> <li>• <b>On</b></li> <li>• <b>Off</b> — default</li> </ul>
<p><b>CPR Prompts</b></p>	
<p><i>Start with CPR Period</i></p>	
<p><i>Start CPR</i></p> <p>At the beginning of the first CPR period, if Start with CPR Period is enabled, the AED Pro issues one of the voice and text prompts shown in the Possible Values column.</p>	<ul style="list-style-type: none"> <li>• <b>Open Airway, Check Breathing, Check Pulse, If no Pulse Start CPR</b></li> <li>• <b>Open Airway, Check Breathing, Check Circulation, If No Circulation Start CPR</b></li> <li>• <b>Start CPR</b> — default</li> <li>• <b>Start Compressions</b></li> <li>• <b>If no Pulse, Start Compressions</b></li> <li>• <b>If no Circulation, Start Compressions</b></li> </ul>

Configurable Option	Possible Values
<p><i>Continue CPR</i></p> <p>When you select one of the prompts in the Possible Values column, that prompt will be repeated once every 10 seconds (default) during the CPR period if compression stops while in the CPR state</p> <p>When this option is set to <b>Off</b>, no prompts will be issued.</p>	<ul style="list-style-type: none"> <li>• <b>OFF</b> — default</li> <li>• <b>If no Circulation, Continue CPR</b></li> <li>• <b>If no Pulse, Continue CPR</b></li> <li>• <b>Continue CPR</b></li> <li>• <b>Continue Compressions</b></li> <li>• <b>If no Pulse, Continue Compressions</b></li> <li>• <b>If no Circulation, Continue Compressions</b></li> </ul>
<p><i>Post Shock CPR Period</i></p>	
<p><i>Start CPR</i></p> <p>At the beginning of the CPR period, after the ECG analysis, the AED Pro issues one of the voice and text prompts shown in the Possible Values column.</p>	<ul style="list-style-type: none"> <li>• <b>Open Airway, Check Breathing, Check Pulse, If no Pulse Start CPR</b></li> <li>• <b>Open Airway, Check Breathing, Check Circulation, If No Circulation Start CPR</b></li> <li>• <b>Start CPR</b> — default</li> <li>• <b>Start Compressions</b></li> <li>• <b>If no Pulse, Start Compressions</b></li> <li>• <b>If no Circulation, Start Compressions</b></li> </ul>
<p><i>Continue CPR</i></p> <p>When you select one of the prompts in the Possible Values column, that prompt will be repeated once every 10 seconds (default) during the CPR period if compression stops while in the CPR state.</p> <p>When this option is set to <b>Off</b>, no prompts will be issued.</p>	<ul style="list-style-type: none"> <li>• <b>OFF</b> — default</li> <li>• <b>If no Circulation, Continue CPR</b></li> <li>• <b>If no Pulse, Continue CPR</b></li> <li>• <b>Continue CPR</b></li> <li>• <b>Continue Compressions</b></li> <li>• <b>If no Pulse, Continue Compressions</b></li> <li>• <b>If no Circulation, Continue Compressions</b></li> </ul>
<p><i>Post No Shock CPR Period</i></p>	
<p><i>Start CPR</i></p> <p>At the beginning of the CPR period after the ECG analysis, the AED Pro issues one of the voice and text prompts shown in the Possible Values column.</p>	<ul style="list-style-type: none"> <li>• <b>Open Airway, Check Breathing, Check Pulse, If no Pulse Start CPR</b></li> <li>• <b>Open Airway, Check Breathing, Check Circulation, If No Circulation Start CPR</b></li> <li>• <b>Start CPR</b> — default</li> <li>• <b>Start Compressions</b></li> <li>• <b>If no Pulse, Start Compressions</b></li> <li>• <b>If no Circulation, Start Compressions</b></li> </ul>

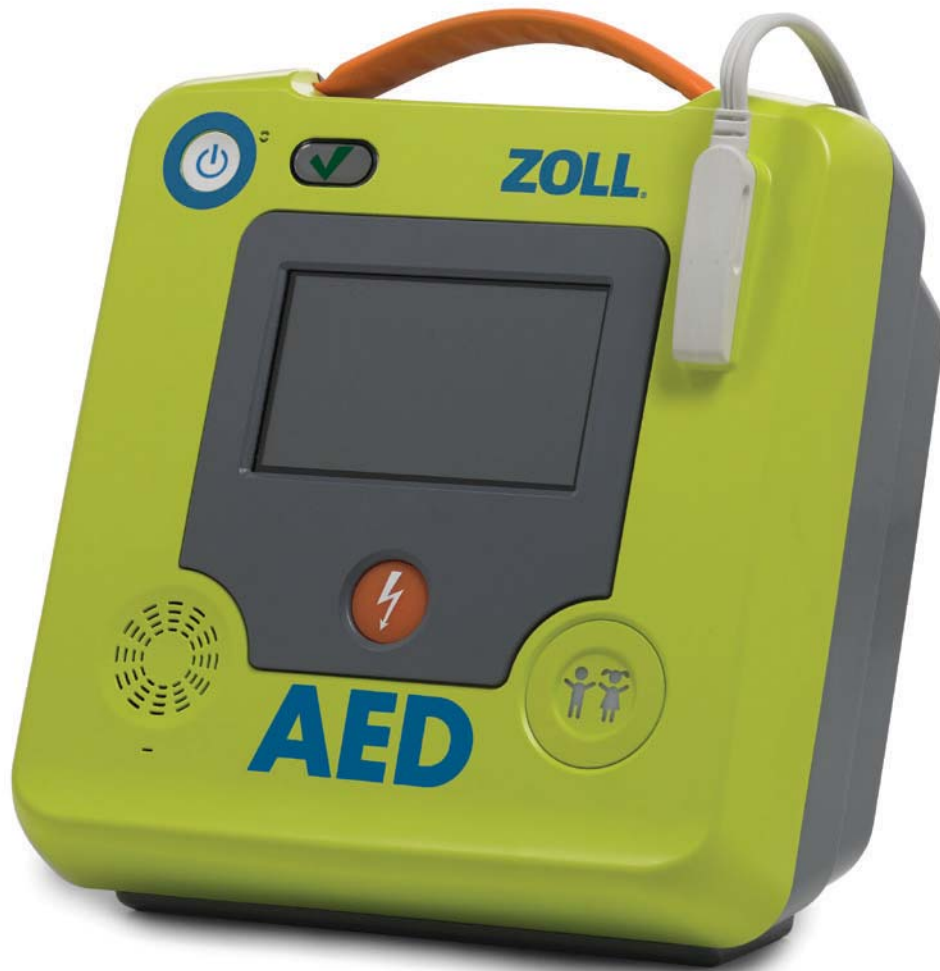
Configurable Option	Possible Values
<p><i>Start CPR</i></p> <p>At the beginning of the first CPR period, if Start with CPR Period is enabled, the AED Pro issues one of the voice and text prompts shown in the Possible Values column.</p>	<ul style="list-style-type: none"> <li>• <b>Open Airway, Check Breathing, Check Pulse, If no Pulse Start CPR</b></li> <li>• <b>Open Airway, Check Breathing, Check Circulation, If No Circulation Start CPR</b></li> <li>• <b>Start CPR</b> — default</li> <li>• <b>Start Compressions</b></li> <li>• <b>If no Pulse, Start Compressions</b></li> <li>• <b>If no Circulation, Start Compressions</b></li> </ul>
<p><i>Continue CPR</i></p> <p>When you select one of the prompts in the Possible Values column, that prompt will be repeated once every 10 seconds (default) during the CPR period if compression stops while in the CPR state.</p> <p>When this option is set to <b>Off</b>, no prompts will be issued.</p>	<ul style="list-style-type: none"> <li>• <b>OFF</b> — default</li> <li>• <b>If no Circulation, Continue CPR</b></li> <li>• <b>If no Pulse, Continue CPR</b></li> <li>• <b>Continue CPR</b></li> <li>• <b>Continue Compressions</b></li> <li>• <b>If no Pulse, Continue Compressions</b></li> <li>• <b>If no Circulation, Continue Compressions</b></li> </ul>
<i>Delays</i>	
<p><i>Continue CPR Delay</i></p> <p>Allows you to set the interval between <i>Continue CPR</i> prompts.</p>	<ul style="list-style-type: none"> <li>• <b>5 seconds</b></li> <li>• <b>10 seconds</b> — default</li> <li>• <b>15 seconds</b></li> </ul>
<p><i>Push Harder Delay</i></p> <p>Allows you to set the interval between <i>Push Harder</i> prompts.</p>	<ul style="list-style-type: none"> <li>• <b>15 seconds</b> — default</li> <li>• <b>20 seconds</b></li> <li>• <b>30 seconds</b></li> </ul>
<b>Audio and Text Prompts</b>	
<p><i>Start CPR</i></p> <p>Allows you to select whether you want to both hear and view the <i>START CPR</i> prompt , or view it only.</p>	<ul style="list-style-type: none"> <li>• <b>Audio and Text</b> — default</li> <li>• <b>Text only</b></li> </ul>
<p><i>Push Harder</i></p> <p>Allows you to select whether you want to both hear and view the <i>Push Harder</i> prompt , or view it only.</p>	<ul style="list-style-type: none"> <li>• <b>Audio and Text</b> — default</li> <li>• <b>Text only</b></li> <li>• <b>OFF</b></li> </ul>
<p><i>Good Compressions</i></p> <p>Allows you to select whether you want to both hear and view the <i>Good Compressions</i> prompt , or view it only.</p>	<ul style="list-style-type: none"> <li>• <b>Audio and Text</b> — default</li> <li>• <b>Text only</b></li> <li>• <b>OFF</b></li> </ul>
<p><i>Continue CPR</i></p> <p>Allows you to select whether you want to both hear and view the <i>Continue CPR</i> prompt , or view it only.</p>	<ul style="list-style-type: none"> <li>• <b>Audio and Text</b> — default</li> <li>• <b>Text only</b></li> </ul>
<p><i>Stop CPR</i></p> <p>Allows you to select whether you want to both hear and view the <i>Stop CPR</i> prompt , or view it only.</p>	<ul style="list-style-type: none"> <li>• <b>Audio and Text</b> — default</li> <li>• <b>Text only</b></li> </ul>

Configurable Option	Possible Values
<b>ECG</b>	
<p><i>Display ECG Waveform</i></p> <p>When this option is checked (<b>On</b>), the unit displays the patient's ECG rhythm.</p>	<ul style="list-style-type: none"> <li>• <b>On</b> — default</li> <li>• <b>Off</b></li> </ul>
<p><i>Monitor BW Filter Cutoff</i></p> <p>Selects the bandwidth filter to be used during ECG monitoring.</p>	<ul style="list-style-type: none"> <li>• <b>1.35 – 22 Hz</b> — default</li> <li>• <b>0.7 – 30 Hz</b></li> </ul>
<p><i>ECG Analysis During CPR</i></p> <p>When this option is checked (<b>On</b>), background ECG analysis begins after the start of a CPR period. If a shockable rhythm is detected during a 12-second period in which CPR is not performed, the unit prompts the rescuer to stop CPR and stand clear. It then initiates ECG analysis.</p> <p>When this option is not checked (<b>Off</b>), the unit does not perform ECG analysis during CPR periods.</p>	<ul style="list-style-type: none"> <li>• <b>Off</b> — default</li> <li>• <b>On</b></li> </ul>
<p><i>Use Analysis After</i></p> <p>When the <i>ECG Analysis During CPR</i> option is checked (<b>On</b>), this option specifies the number of seconds to delay background ECG analysis after a no-shock or post-shock CPR period begins.</p>	<ul style="list-style-type: none"> <li>• <b>0 seconds</b> — default</li> <li>• <b>15 seconds</b></li> <li>• <b>30 seconds</b></li> <li>• <b>45 seconds</b></li> <li>• <b>60 seconds</b></li> <li>• <b>120 seconds</b></li> <li>• <b>180 seconds</b></li> </ul>
<p><i>See-Thru CPR</i></p> <p>When this option is checked (<b>On</b>), See-Thru CPR is enabled for the AED Pro (see page 4-5 for information on using See-Thru CPR.).</p>	<ul style="list-style-type: none"> <li>• <b>On</b></li> <li>• <b>Off</b> — default</li> </ul>
<p><i>Archive ECG AF Data</i></p> <p>When this option is checked (<b>On</b>), the See-Thru CPR adaptive filter information will be saved.</p>	<ul style="list-style-type: none"> <li>• <b>On</b></li> <li>• <b>Off</b> — default</li> </ul>
<b>Monitoring</b>	
<p><i>ECG Monitoring Modes</i></p> <p>When this option is checked (<b>On</b>), the unit switches to ECG monitoring mode when an ECG cable is attached or when the left softkey is pressed and held for at least 5 seconds in semiautomatic mode.</p> <p>When this option is not checked (<b>Off</b>), the unit does not support ECG monitoring mode. If an ECG cable is attached, the unit prompts the rescuer to plug in a defibrillation cable.</p>	<ul style="list-style-type: none"> <li>• <b>On</b> — default</li> <li>• <b>Off</b></li> </ul>
<p><i>Display Heart Rate</i></p> <p>When this option is checked (<b>On</b>), the unit displays the patient heart rate in manual mode.</p>	<ul style="list-style-type: none"> <li>• <b>On</b> — default</li> <li>• <b>Off</b></li> </ul>



Configurable Option	Possible Values
<p><i>Low Heart Rate Limit</i></p> <p>In manual or ECG monitoring mode, the unit issues the prompt <i>CHECK PATIENT</i> if the patient heart rate falls below this number of beats per minute.</p>	<ul style="list-style-type: none"> <li>• 0</li> <li>• 30 — default</li> <li>• 35</li> <li>• 45</li> <li>• 50</li> <li>• 55</li> <li>• 60</li> <li>• 65</li> <li>• 75</li> <li>• 80</li> <li>• 85</li> <li>• 90</li> <li>• 100</li> </ul>
<p><b>Patient Impedance</b></p>	
<p><i>Archive Patient Impedance</i></p> <p>Enables or disables the archiving of patient impedance data.</p>	<ul style="list-style-type: none"> <li>• On — default</li> <li>• Off</li> </ul>

(This page intentionally left blank.)



## **Indications for Use**

The ZOLL AED 3 system is indicated for use when a suspected cardiac arrest victim has an apparent lack of circulation as indicated by:

- Unconsciousness
- Absence of breathing, and
- Absence of pulse and other signs of circulation.

The AED 3 system is indicated for adult and pediatric patients.

## **Contraindications for Use**

Never use the unit for defibrillation when the patient

- Is conscious
- Is breathing, or
- Has a detectable pulse or other sign of circulation.

## **General Information**

Federal (U.S.A.) law restricts this defibrillator to sale by or on the order of a physician.

The issue date for the ZOLL AED 3 Administrator's Guide (REF 9650-000752-01-50 Rev. 3) is **December, 2017**.

Copyright © 2017 ZOLL Medical Corporation. All rights reserved. CPR-D-padz, M Series, Pedi-padz, Real CPR Help, Rectilinear Biphasic, RescueNet, Stat-padz, ZOLL, and ZOLL AED 3 are trademarks or registered trademarks of ZOLL Medical Corporation in the United States and/or other countries.

 **ZOLL Medical Corporation**  
269 Mill Road  
Chelmsford, MA USA  
01824-4105

 **ZOLL International Holding B.V.**  
Newtonweg 18  
6662 PV ELST  
The Netherlands

  
0123



---

# Table of Contents

## Preface

Conventions .....	viii
ZOLL AED 3 Safety Considerations .....	viii
Tracking Requirements .....	viii
Notification of Adverse Events .....	ix
Technical Service .....	ix
International Customers .....	x
Software Licensing Statement .....	x

## Chapter 1 Overview

ZOLL AED 3 User Interface .....	2
Child Mode .....	2
Real CPR Help .....	2
Using Defibrillation Pads .....	3
Data Recording and Storage .....	4
Post Event Analysis .....	4
Transferring Files Using a USB Flash Drive .....	4
Wi-Fi Communication .....	4
ZOLL AED 3 Operation .....	5
Operating Controls and Indicators .....	5
Graphical Display Area .....	6
AED Management Mode .....	6
Rescue Mode .....	7
Audio Prompts .....	9

## Chapter 2 Data Transfer

Data Storage .....	14
Data and Audio Recording .....	14
Exporting Files From the AED .....	15
Exporting Files .....	15
Using RescueNet Code Review Software .....	16
Using Case Review Software .....	16
Importing Files from a USB Flash Drive .....	16
Importing Files .....	17
Troubleshooting Communication Issues .....	18

## Chapter 3 Maintenance

Self Tests .....	21
Self Test Functions .....	22
Automatic Self-Test Transfer .....	22
Optional Maintenance Tests .....	24
Physical Inspection .....	24
Cleaning the ZOLL AED 3 Defibrillator .....	24

---

Optional Maintenance Test for Technical Professionals .....	25
Test Procedure (ZOLL AED 3 and ZOLL AED 3 BLS Models) .....	25
Test Procedure (ZOLL AED 3 Automatic Models) .....	26
Battery Maintenance .....	27
Identifying Battery Conditions .....	27
<b>Chapter 4 Troubleshooting</b>	
Troubleshooting the AED .....	29
<b>Appendix A Symbols</b>	
Symbols .....	33
<b>Appendix B Specifications</b>	
Defibrillator Specifications .....	37
Guidance and Manufacturer's Declaration - Electromagnetic	
Compatibility .....	40
Rectilinear Biphasic Waveform Characteristics .....	44
Clinical Trial Results for the M Series Biphasic Waveform .....	49
Randomized Multicenter Clinical Trial for Defibrillation of	
Ventricular Fibrillation (VF) and Ventricular Tachycardia (VT) .....	49
Pre-Clinical Study .....	50
Published Clinical Data .....	51
ECG Analysis Algorithm Accuracy .....	53
Clinical Performance Results .....	54
Wireless Output Guidance and Manufacturer's Declaration .....	56
RF Transmission Emitted (IEC 60601-1-2) .....	56
FCC Notice .....	56
Canada, Industry Canada (IC) Notices .....	56
<b>Appendix C Accessories</b>	
Accessories .....	57
<b>Appendix D Configuration Settings</b>	
Overview .....	59
Setting Up Your Wireless Configuration .....	65
For IT Setup Only .....	65
Entering Supervisor Configuration Mode .....	66
Setting Up Clinical Archive Wi-Fi Configuration .....	66
Quick Setup for Clinical Archives .....	66
IT Setup for Clinical Archives .....	67
Setting Up Device History Wi-Fi Configuration .....	69
Quick Setup for Device History .....	69
IT Setup for Device History .....	70



# Preface

The ZOLL AED 3™ defibrillator is an Automated External Defibrillator (AED) that is designed to be used for both adult and child victims of sudden cardiac arrest. The defibrillator incorporates a sequence of audio and visual prompts to help rescuers follow established current AHA/ERC/ILCOR Guidelines for use of AEDs. This guide provides information about the operation and care of the ZOLL AED 3 defibrillator. The *ZOLL AED 3 Administrator's Guide* is to be used by trained medical personnel in conjunction with the *ZOLL AED 3 Operator's Manual*.

This guide contains the following sections:

**Chapter 1—Overview** describes a general product overview of the ZOLL AED 3 defibrillator.

**Chapter 2—Data Transfer** provides instructions on how to transfer data that is stored on the AED.

**Chapter 3—Maintenance** provides the recommended procedures for evaluating the condition and performance of the ZOLL AED 3 defibrillator.

**Chapter 4—Troubleshooting** describes possible problems and solutions and lists the error log messages that indicate the AED requires technical service.

**Appendix A**—Contains a list of symbols that may be used in this guide or on the ZOLL AED 3 defibrillator.

---

**Appendix B**—Contains specification information and the ZOLL® Rectilinear Biphasic™ waveforms that are produced when the ZOLL AED 3 defibrillator is discharged into loads of 25, 50, 75, 100, 125, 150, and 175 ohms at each energy setting (200, 150, 120, 85, 70, and 50 joules).

**Appendix C**—Contains a list of accessories for the ZOLL AED 3 defibrillator.

**Appendix D**—Contains definitions of all configuration settings for the ZOLL AED 3 defibrillator and provides instructions for setting up your wireless configuration.

## Conventions

Throughout this document, text prompts and voice prompts are indicated by capital italicized letters, such as *CALL FOR HELP*.

**WARNING!** Warning statements describe conditions or actions that can result in personal injury or death.

**CAUTION** Caution statements describe conditions or actions that can result in damage to the defibrillator.

**NOTE** Notes contain important additional information on using the defibrillator.

## ZOLL AED 3 Safety Considerations

Only qualified personnel should service an ZOLL AED 3 defibrillator. Before using this defibrillator, read the *ZOLL AED 3 Operator's Manual*. Before servicing any equipment, review these safety considerations and read this manual carefully.

**WARNING!** The ZOLL AED 3 defibrillator can generate as much as 2250 volts with sufficient current to cause lethal shocks.

Before discharging the defibrillator, warn everyone near the equipment to *STAND CLEAR*.

Do not recharge, disassemble, or dispose of the battery in fire. The battery might explode if mishandled.

## Tracking Requirements

U.S Federal Law (21 CFR 821) requires the tracking of defibrillators. As an owner of this defibrillator, you have the responsibility under this law to notify ZOLL Medical Corporation if this product has been received, lost, stolen or destroyed or has been donated, resold or otherwise distributed to a different organization.

If any of the events described above occur, please contact ZOLL Medical Corporation in writing with the following information:

1. Originator's organization - Company Name, Address, Contact Name and Contact Phone Number.
2. Part Number/Model Number and Serial Number.

- 
3. Disposition of Device (e.g. received, lost, stolen destroyed, distributed to another organization).
  4. New Location and/or Organization (if different from #1 above) - Company Name, Address, Contact Name and Contact Phone number.
  5. Date change took effect.

## Notification of Adverse Events

As a health care provider, you may have responsibilities under the Safe Medical Devices Act (SMDA) for reporting to ZOLL and possibly to the Food and Drug Administration (FDA), the occurrence of certain events. These events, described in 21 CFR Part 803, include device related death and serious injury or illness. In any event, as part of our Quality Assurance Program, ZOLL should be notified of any device failure or malfunction. This information is required to assure that ZOLL provides only the highest quality products.

### Technical Service

If a ZOLL product requires service, contact the ZOLL Technical Service Department or the nearest ZOLL sales office or distributor:

Telephone: 1-978-421-9655

Toll free: 1-800-348-9011

Fax: 1-978-421-0010

Email: techsupport@zoll.com

Have the following information available for the Technical Service representative:

- Serial number
- Description of the problem

If you need to send the ZOLL AED 3 defibrillator to ZOLL Medical Corporation, obtain a service order request number from the Technical Service representative.

**NOTE** Before sending the defibrillator and battery to ZOLL, check with your local shipping company to see if there are any restrictions on shipping lithium batteries.

Remove the battery pack from the defibrillator and return the AED and battery pack in its original container (or equivalent packaging) with the service order request number on it to the following address:

ZOLL Medical Corporation  
269 Mill Road  
Chelmsford, MA 01824-4105  
Attn: Technical Service Department

---

## **International Customers**

Customers outside of the United States should remove the battery pack from the AED and return the AED and battery pack in its original container (or equivalent packaging) to the nearest authorized ZOLL Medical Corporation Service Center. To locate an authorized service center, contact the nearest ZOLL sales office or authorized distributor. For a list of ZOLL offices, please visit:  
<http://www.zoll.com/contact/worldwide-locations/>.

## **Software Licensing Statement**

Certain software components (referred to herein as "Open Source Components") that are used in this product are licensed by ZOLL Medical Corporation (referred to herein as "ZOLL Medical") under various open source license agreements. As required by the terms of these open source license agreements, ZOLL Medical offers to make the source code corresponding to the Open Source Components, and any ZOLL Medical modifications thereof, available upon request.

# Chapter 1

## Overview

The ZOLL AED 3 defibrillator is an Automated External Defibrillator (AED) that is designed to be used for both adult and child victims of sudden cardiac arrest. The AED uses audio and visual prompts to guide the rescuer through a resuscitation sequence that may include defibrillation and/or cardiopulmonary resuscitation (CPR). The ZOLL AED 3 defibrillator has a liquid crystal display (LCD) touch screen and uses detachable defibrillation pads. The defibrillation pads include an intelligent CPR sensor that allows the AED to monitor chest compressions and provide feedback during CPR.

This guide contains instructions for all ZOLL AED 3 models:

- **ZOLL AED 3** — Operates in Semi-Automatic Mode. Includes lay rescuer prompts and graphics, and Real CPR Help<sup>®</sup> for CPR monitoring and feedback.
- **ZOLL AED 3 *Automatic*** — Operates in Fully Automatic Mode. Includes lay rescuer prompts and graphics, and Real CPR Help for CPR monitoring and feedback.
- **ZOLL AED 3 *BLS*** — Operates in Semi-Automatic Mode. Includes Real CPR Help for CPR monitoring and feedback, optional patient ECG display, CPR Dashboard, optional lay rescuer graphics, and optional audio recording.

---

When the rescuer attaches defibrillation pads to a patient's chest, the AED monitors and analyzes the electrocardiographic (ECG) rhythm of the patient's heart to determine whether or not the ECG rhythm is shockable. If the AED detects a shockable rhythm, it either issues instructions to deliver the shock (semi-automatic) or automatically delivers the shock (fully automatic). The ZOLL AED 3 defibrillator then prompts the rescuer to perform CPR for a period of time (configured by the AED Administrator), after which the AED automatically initiates a new ECG analysis.

## ZOLL AED 3 User Interface

The ZOLL AED 3 defibrillator has a Status Indicator that allows you to quickly see if it has passed its last self test and is ready for use. An LCD screen in the center of the front panel provides text prompts, rescue graphics, and incident information. The AED defibrillator provides audio prompts through a speaker located on the front of the AED. The front panel of the AED has an On/Off button on the top left side of the device and a Shock button beneath the LCD screen. It also has a Child button for patients that are less than 8 years old or weigh less than 55 pounds (25 kg).

The ZOLL AED 3 defibrillator has two operating modes: AED Management Mode and Rescue Mode. In AED Management Mode, the icons on the touch screen allow you to change configuration settings and upload clinical archives, device history, and configuration files. There is also a Supervisor menu for advanced users to make more complex changes to the AED, such as device configuration, shock settings, and CPR settings.

In Rescue Mode, the LCD screen displays graphics that are coordinated with audio prompts to guide the rescuer through the necessary steps to perform a rescue. The steps that include graphics and audio prompts are defined by local protocols for use of an AED.

## Child Mode

The ZOLL AED 3 defibrillator has a Child mode that is enabled when the rescuer uses ZOLL Pedi-padz<sup>®</sup> II defibrillation pads. In this mode, the AED uses configured pediatric energy settings that are lower doses of energy than those used for adults. The ZOLL AED 3 defibrillator also uses a pediatric AED analysis algorithm that is specifically designed for a child's ECG. This algorithm accurately distinguishes shockable versus non-shockable rhythms in the pediatric patient.

## Real CPR Help

The ZOLL AED 3 adult CPR defibrillation pads include a sensor that detects the rate and depth of chest compressions. This sensor is part of the defibrillation pads that the rescuer places on the patient's chest, and must be located between your hands and the patient's lower sternum. When the rescuer performs CPR compressions, the sensor detects the rate and depth and sends the information

---

to the AED. The ZOLL AED 3 defibrillator includes a CPR audio metronome function designed to encourage the rescuer to perform chest compressions at the AHA/ERC/ILCOR recommended minimum rate of at least 100 compressions per minute (CPM). The AED performs CPR monitoring, prompts the rescuer, and records chest compressions in the clinical patient file.

**WARNING! Real CPR Help audio prompts are not enabled in Child mode.**

When performing CPR on adult patients, the ZOLL AED 3 defibrillator may issue one or more audible prompts based on the depth of chest compressions detected. If Real CPR Help determines that compression depth is consistently less than 5 centimeters, the AED issues a *PUSH HARDER* prompt. The AED issues a *GOOD COMPRESSIONS* prompt if the rescuer responds by increasing compression depth to 5 centimeters or more.

## Using Defibrillation Pads

The ZOLL AED 3 defibrillator is compatible with the following adult and child defibrillation pads:

- CPR-D-padz<sup>®</sup> (for adults only)
- CPR Stat-padz<sup>®</sup> (for adults only)
- Stat-padz II (for adults only)
- Pedi-padz II (for children only)

Make sure that the defibrillation pads used are appropriate for the patient.

**NOTE** When using Pedi-padz II, the Child button automatically lights up.

The pads package is connected to the AED by a cable. The package contains defibrillation pads that the rescuer attaches to the patient. The pad package includes scissors for cutting clothing or chest hair off the patient.

If the defibrillation pads cable is not attached properly, the AED issues the *PLUG IN PADS CABLE* prompt. Make certain to connect the defibrillation pad cable to the ZOLL AED 3 defibrillator and attach the pads to the patient properly.

**WARNING! Defibrillation pads must be pre-attached to the device. Keep the defibrillation pad cable connected to the AED at all times.**

**NOTE** Defibrillation pads contain no hazardous materials and may be disposed of in general trash unless contaminated with pathogens. If contaminated, appropriate precautions should be used in their disposal.

**WARNING! DO NOT reuse defibrillation pads.**

---

## Data Recording and Storage

All ZOLL AED 3 models can record and store up to 120 minutes of continuous ECG/audio and clinical event data during a rescue or patient case. See “Data and Audio Recording” on page 14 for more detailed information about this function.

## Post Event Analysis

All ZOLL AED 3 models automatically store patient clinical data and device history in long-term memory.

- Patient clinical data (clinical archives) — Includes date and time notation that you can view and analyze using ZOLL RescueNet® Code Review software or view online with ZOLL RescueNet Case Review (requires ZOLL Online account and ZOLL AED 3 device to transmit clinical event data over Wi-Fi).
- Device history — A log of device status information that you can view and analyze. You can transfer this file over Wi-Fi or upload it using a USB flash drive.

## Transferring Files Using a USB Flash Drive

All ZOLL AED 3 models have a USB port that allows you to export and save configuration settings, clinical archives, and device history to a USB flash drive. This feature allows you to easily copy a configuration from one AED to other AEDs. The USB port also allows you to import new system software to quickly upgrade the AED.

## Wi-Fi Communication

All ZOLL AED 3 models have wireless communication that provides automatic upload of self-test reports and on-demand transfer of patient clinical archives and device history information through a wireless access point.

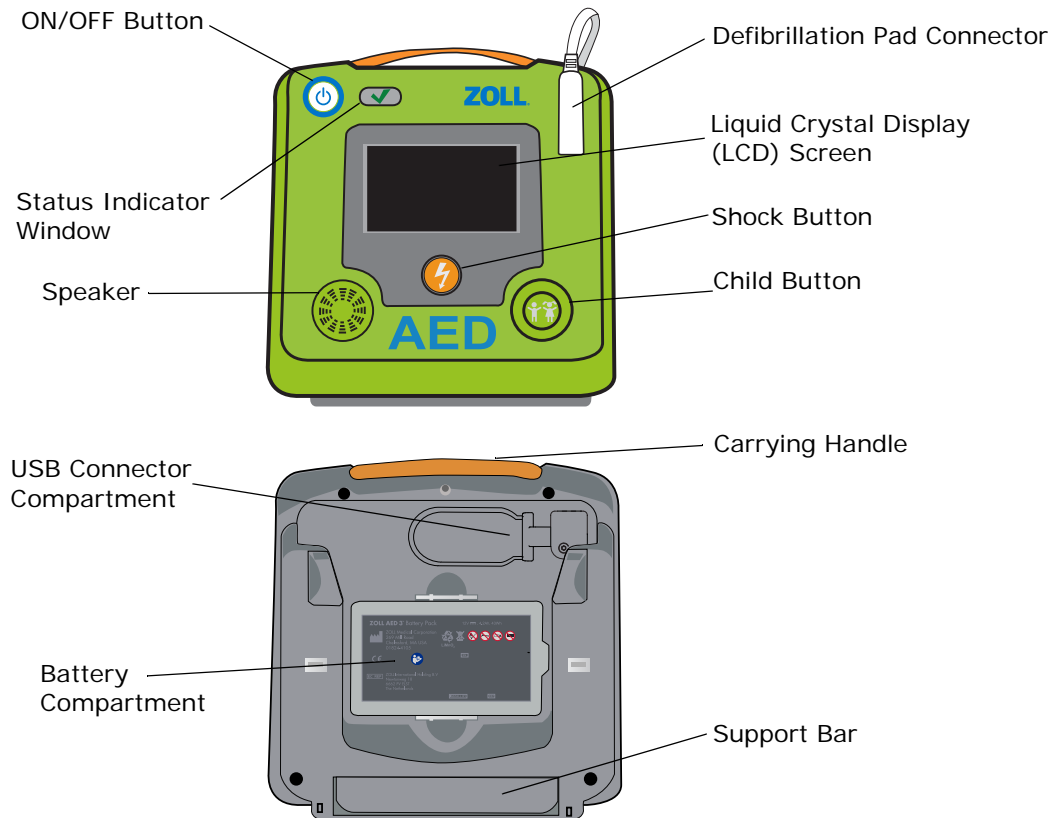


---

# ZOLL AED 3 Operation

## Operating Controls and Indicators

This section describes the functions of the controls on the front of the ZOLL AED 3 defibrillator.



**ON/OFF Button** — Turns power ON or OFF.

When pressed and held for at least 5 seconds, the AED initiates a self test and enters AED Management Mode.



AED Passed  
Self Test

**Status Indicator Window** — Green check indicates that the AED passed its last self test and is ready for use.



AED Failed  
Self Test

A blank window indicates that the AED has failed its self test and is not ready for use.

**Speaker** — Provides audio prompts and metronome beeps that direct rescuers on what to do during a rescue; also provides audio prompts to indicate if service is required.

**Defibrillation Pad Connector** — This connector is used to attach defibrillation pads to the AED.

**Liquid Crystal Display (LCD) Screen** — A 5.3 x 9.5 centimeter touch screen for display and user input. During a rescue, it displays graphics and text messages to guide the rescuer.



**Shock Button** — Illuminates when the AED is charged and ready to deliver a shock to the patient.

When pressed, the charged and ready AED discharges its energy into the patient.



**Child Button** — Illuminated button indicates the AED is in Child Mode to prepare a rescue for a pediatric patient. Automatically illuminates when using Pedi-padz II.

**USB Connector Compartment** — Contains a connection for a USB flash drive when importing or exporting files to or from the AED.

**Battery Compartment** — Holds the battery pack used to power the AED.

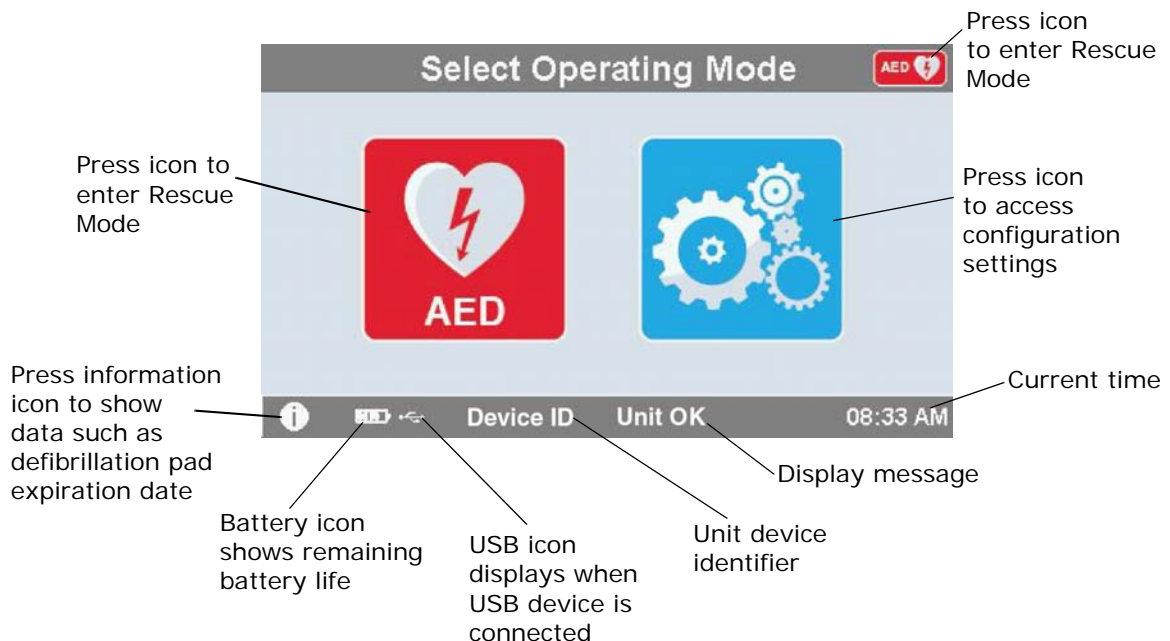
**Carrying Handle** — The strap designed for carrying the AED.

**Support Bar** — The brace that opens to hold the AED in an upright position.

## Graphical Display Area

The ZOLL AED 3 defibrillator has a 5.3 x 9.5 centimeter LCD screen that displays the following information in the modes in this section: AED Management Mode and Rescue Mode.

### AED Management Mode

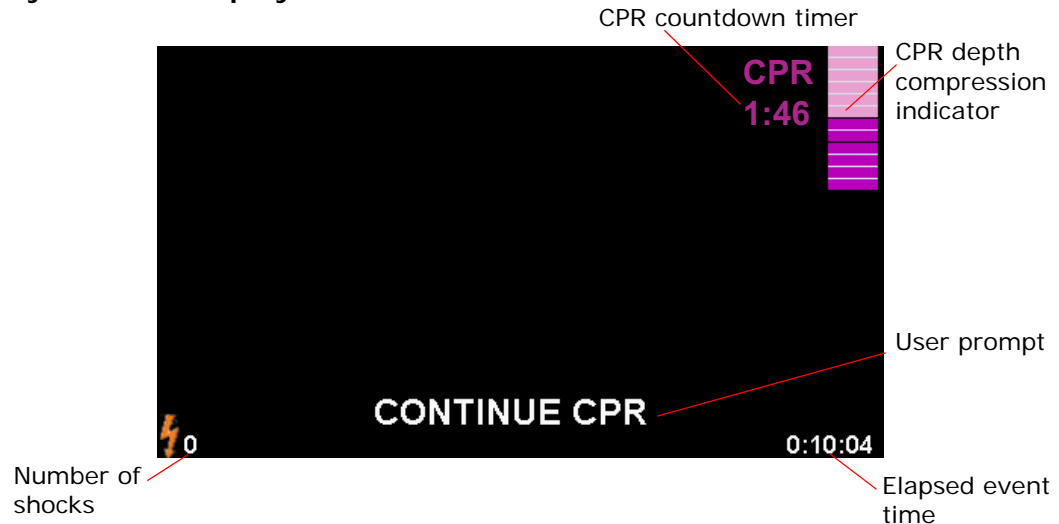


---

## Rescue Mode

The ZOLL AED 3 and ZOLL AED 3 *Automatic* models show the Lay Rescuer display, while the ZOLL AED 3 *BLS* model can be configured to show the Lay Rescuer display, CPR only display, or CPR and ECG display.

### Lay Rescuer Display



**CPR Countdown Timer** -- Indicates the amount of time remaining in the CPR interval.

**CPR Depth of Compression Indicator** -- A bar graph that displays the depth of chest compressions measured while the rescuer is performing CPR. Indicator lines are displayed in the bar graph at 2 and 2.4 inches (5 and 6 centimeters) of compression depth and provide reference points for rescuers performing CPR.

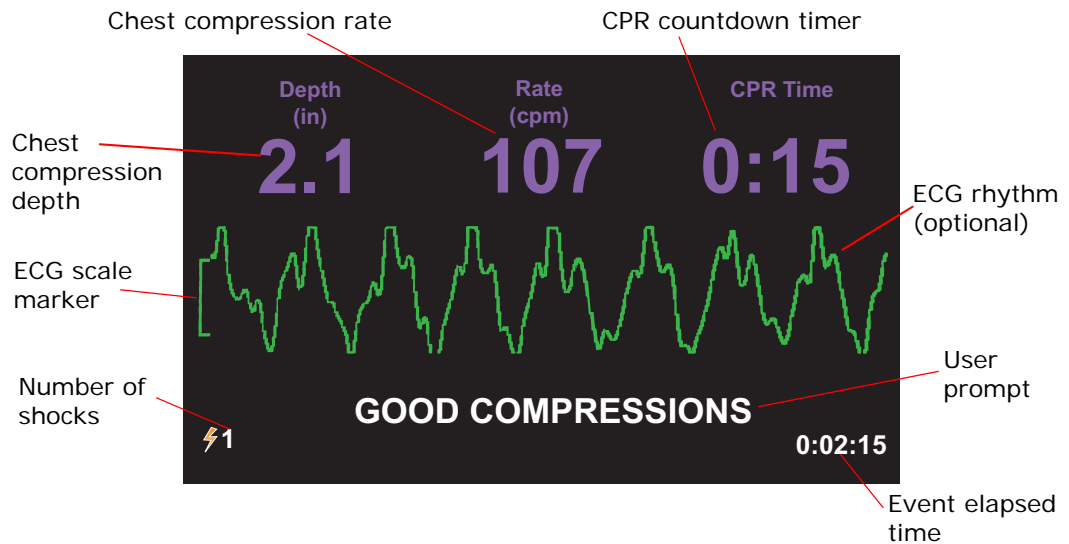
**User Prompt** -- Displays a visual message on the screen while simultaneously issuing an audio prompt.

**Elapsed Event Time** -- Indicates the amount of time that has elapsed since the start of the rescue.

**Number of Shocks** -- Indicates the total number of defibrillation shocks delivered during the rescue.

---

## CPR Only/CPR and ECG Displays (ZOLL AED 3 BLS models only)



**Chest Compression Depth** — Indicates the depth of the current CPR compressions.

**NOTE** If the chest compression depth is outside of the recommended AHA/ERC range, the AED highlights the depth value inside a red box.

**Chest Compression Rate** — Indicates the rate of the current CPR compressions.

**NOTE** If the chest compression rate is outside of the recommended AHA/ERC range, the AED highlights the rate value inside a red box.

**CPR Countdown Timer** — Indicates the amount of time remaining in the CPR interval.

**ECG Rhythm (optional)** — Displays the current ECG waveform.

**User Prompt** — Displays a visual message on the screen while simultaneously issuing an audio prompt.

**Event Elapsed Time** — Indicates the amount of time that has elapsed since the start of the rescue.

**Number of Shocks** — Indicates the total number of defibrillation shocks during the rescue.

---

## Audio Prompts

During clinical use of the ZOLL AED 3 defibrillator, you may hear the following audio prompts:

**Table 1. Clinical Audio Prompts**

<b>Audio Prompt</b>	<b>Definition/Action</b>
<i>AUTOMATIC DEFIBRILLATOR</i>	The AED is the fully automatic model that has the capability to automatically shock the patient without the rescuer having to press the Shock button.
<i>UNIT OK</i>	The AED has successfully passed its power up self tests.
<i>UNIT FAILED</i>	The AED has failed its power up self tests and is not usable for patient care.
<i>CHANGE BATTERY</i>	The ZOLL AED 3 self test has detected a low battery condition that is insufficient for the AED's use for patient care. Replace battery pack with a new one as soon as possible.
<i>BATTERY HAS BEEN REPLACED</i>	The AED has detected that the battery has been changed.
<i>PLUG IN PADS CABLE</i>	Ensure that the defibrillation cable is properly connected to the ZOLL AED 3 defibrillation connector.
<i>ATTACH CORRECT DEFIB PADS</i>	Pads that are connected to the AED are not compatible with the ZOLL AED 3 defibrillator.
<i>CHECK PADS</i>	Previously attached defibrillation pads are not making good contact with the patient's skin or the pads are defective.
<i>REPLACE PADS</i>	There is a problem with the pads connected to the AED. Attach new pads to the AED.
<i>ADULT PADS</i>	Adult pads (CPR-D-padz, CPR Stat-padz, Stat-padz II) are attached to the AED.
<i>PEDIATRIC PADS</i>	Pedi-padz II are attached to the AED.
<i>STAY CALM</i>	Relax as much as possible and focus on the rescue effort.
<i>CHECK RESPONSIVENESS</i>	Check patient for responsiveness/consciousness by gently shaking the patient and shouting "Are you all right?"
<i>CALL FOR HELP</i>	Call EMS for assistance or ask a bystander to do it for you.
<i>OPEN AIRWAY</i>	Place patient in the supine position and perform Head Tilt – Chin Lift or Jaw – Thrust maneuver to open patient's airway.

<b>Audio Prompt</b>	<b>Definition/Action</b>
<i>CHECK BREATHING</i>	Look, listen, or feel for the presence of breathing and/or airflow from the patient's lungs.
<i>REMOVE PAD PACKAGE</i>	Remove the defibrillation pad package from the back of the AED.
<i>CUT OR TEAR CLOTHING TO EXPOSE PATIENT'S BARE CHEST</i>	If needed, use scissors to completely remove the patient's shirt.
<i>COMPLETELY REMOVE CHILD'S SHIRT, CUTTING OR TEARING IF NEEDED</i>	If needed, use scissors to completely remove child's shirt.
<i>OPEN PAD PACKAGE</i>	Tear open the defibrillation pad package to access the defibrillation pads.
<i>ATTACH PADS TO PATIENT'S BARE CHEST</i>	Attach defibrillation pads to the patient's bare chest.
<i>ATTACH PADS TO CHILD'S BACK AND CHEST</i>	Attach defibrillation pads to child's bare back and chest as shown.
<i>DON'T TOUCH PATIENT ANALYZING</i>	Do not touch the patient; an ECG rhythm analysis is in progress or about to begin.
<i>NO SHOCK ADVISED</i>	ECG rhythm analysis has detected a rhythm that is not treatable by defibrillation.
<i>SHOCK ADVISED</i>	ECG rhythm analysis has detected the presence of ventricular fibrillation or shockable ventricular tachycardia.
<i>DON'T TOUCH PATIENT. PRESS THE FLASHING SHOCK BUTTON.</i>	Warn all persons in attendance to stand clear and stop touching the patient. Press the Shock Button to deliver defibrillation therapy.
<i>RELEASE SHOCK BUTTON</i>	The Shock Button was pressed before the defibrillator was ready to defibrillate. Release the Shock Button and press again after the ready tone sounds.
<i>SHOCK WILL BE DELIVERED IN THREE, TWO, ONE</i>	(ZOLL AED 3 <i>Automatic</i> model only) The AED will automatically deliver shock after the countdown completes.
<i>SHOCK DELIVERED</i>	A defibrillation shock has just been delivered to the patient.
<i>NO SHOCK DELIVERED</i>	No shock was delivered to the patient because rescuer failed to press Shock Button or an error condition was detected.
<i>START CPR</i>	Begin CPR.
<i>PUSH TO MATCH THE TONE</i>	Announced at the start of the CPR period. (Adult patients only).
<i>PUSH HARDER</i>	CPR compressions are consistently less than 5 centimeters deep. (Adult patients only)

<b>Audio Prompt</b>	<b>Definition/Action</b>
<i>GOOD COMPRESSIONS</i>	After prompting to Push Harder, rescuer has succeeded in delivering chest compressions at least 5 centimeters deep. (Adult patients only)
<i>CONTINUE CPR</i>	Continue providing CPR. This prompt may also be issued if Real CPR Help fails to detect chest compressions at least 2 centimeters deep. (Adult patients only).
<i>ANALYSIS HALTED. KEEP PATIENT STILL.</i>	ECG rhythm analysis has been halted due to excessive ECG signal artifact. Stop any ongoing CPR and keep the patient as motionless as possible.
<i>GIVE TWO BREATHS</i>	If patient is not breathing, give two rescue breaths.
<i>STOP CPR</i>	Stop CPR. The AED is about to begin an ECG rhythm analysis.
<i>CPR ONLY MODE</i>	Defibrillation is not working properly; AED will only provide CPR support.

Prompts that you may hear during non-clinical use of the ZOLL AED 3 defibrillator include:

**Table 2. Non-Clinical Audio Prompts**

<b>Audio Prompt</b>	<b>Definition</b>
<i>REPLACE PADS</i>	The ZOLL AED 3 self test has detected that the defibrillation pads have passed their expiration date. Replace the defibrillation pads immediately.
<i>CHANGE BATTERY</i>	The ZOLL AED 3 self test has detected that the battery has passed its install by date. Replace the battery pack immediately.
<i>UNIT POWERING OFF</i>	The AED is shutting down.





# Chapter 2

## Data Transfer

The ZOLL AED 3 defibrillator automatically stores patient clinical data and device history information. You can access this data and transfer it to a remote device (such as a computer) using either a USB flash drive or a wireless access point. The AED stores the patient clinical event data with the date and time notation. You can view and analyze this information using ZOLL RescueNet Code Review software or ZOLL RescueNet Case Review software through ZOLL Online.

You can transfer information to the AED such as a software upgrade or configuration settings using a USB flash drive. This allows you to quickly and easily update software or copy a configuration to multiple AEDs.



Device  
Configuration  
Icon

In order to transfer data, the ZOLL AED 3 defibrillator must be in AED Management mode. To enter AED Management Mode, press and hold the On/Off button for at least 5 seconds, then press the Device Configuration icon on the main display screen. While in AED Management mode, you can export data at any time to a USB flash drive or a wireless access point.

**NOTE** The AED retains device history and clinical event data even when powered off or when the battery pack is removed. When the AED is powered on and defibrillation pads are attached to a new patient, the new clinical data replaces the old clinical data once the AED has stored data for one or two patients (default is two).

---

## Data Storage

The ZOLL AED 3 defibrillator stores the following patient clinical archive and device history data:

### ***Clinical Archive Data (.crd)*** ***(Clinical Event File)***

- Elapsed time (since power on)
- Continuous ECG Data
- Number of patient shocks
- Selected energy
- Patient impedance
- Audio prompts
- Audio recording (if applicable)
- Power on (date and time)
- Indication of defibrillation pad attachment
- Results of ECG analysis
- CPR data
- Errors

### ***Device History Data (.dhf)*** ***(Self-Test Report)***

- AED serial number
- Battery status
- Defibrillation pad information
- Hardware revision number
- Software revision number
- Date/time and results of last self test
- Error codes in most recent self test

The ZOLL AED 3 defibrillator generates device history data when it performs a self-test during power up or at a scheduled time during sleep state. When the AED detects system issues it saves these issues in device log files.

## Data and Audio Recording

The ZOLL AED 3 *BLS* model has an audio recording option that can be configured on or off. If the audio recording option is on, the ZOLL AED 3 *BLS* model can record and store 60 minutes of continuous audio, ECG, and clinical event data. If the audio recording option is off, the ZOLL AED 3 *BLS* model can record and store 120 minutes of clinical event data and ECG data. The recorded audio data is synchronized to the clinical event data. The audio recording starts when defibrillation pads are attached and the AED completes its automatic self tests.

All ZOLL AED 3 models can be configured to store one or two patient cases containing ECG, audio (*BLS* model), and clinical event data. When the AED is configured to store two cases and a clinical event is detected in rescue mode, the AED deletes the oldest of the two previously stored cases from memory before recording data for the current rescue. If the AED is configured to store one case, it deletes the stored case from memory before recording data for the current rescue. Deleting of old ECG, audio, and event data occurs 15 seconds after the defibrillation pads are properly connected to the patient. If the ZOLL AED 3 defibrillator is started in AED Management Mode, the recorded data of the last rescue is retained and may be transferred using a wireless connection or USB flash drive.

---

## Exporting Files From the AED

You can export the following data from a ZOLL AED 3 defibrillator:

- Clinical Archives (using USB or Wi-Fi)
- Device History (using USB or Wi-Fi)
- Configuration (using USB)

**NOTE** When transferring files via USB, the USB flash drive must be USB 1.1 or 2.0 compliant.

**NOTE** You do not need Supervisor access to export data files to a USB flash drive or wireless access point.

## Exporting Files

Use the following procedure to transfer files from the AED.

**NOTE** You cannot transfer configuration files through a wireless connection.

In order to transfer data via a wireless connection, you need to create a wireless profile. If you have not already done so, see .

**WARNING! Do not connect the AED to a computer or other device (via the USB port) while the AED's defibrillation pads are still connected to the patient.**



Device  
Configuration  
icon

1. Press and hold the On/Off button for longer than 5 seconds, then press the Device Configuration icon to enter AED Management mode.
2. If you are transferring data:
  - Using a wireless connection, go to step 3.
  - Using a USB flash drive, insert the flash drive into the USB connector on the back of the AED. The USB device icon ( •↔ ) appears in the status bar at the bottom of the display screen.



Export Files  
icon

3. Press the Export Files icon and select the following data option(s) to transfer:
  - Clinical Archives (all)
  - Clinical Archives (new)
  - Device History
  - Configuration (USB only)

A green check displays next to the option(s) you have selected.

4. Press **Save (USB)** or **Send (Wi-Fi)**. When the AED has finished transferring data, it issues the prompt, *DATA TRANSFER COMPLETE*.
5. Press **OK** to return to the previous screen.

**NOTE** If you rename a configuration file with the intention of importing it into another ZOLL AED 3 defibrillator, do not include spaces in the file name.

---

You can transfer clinical archives (patient data) for use with ZOLL RescueNet Code Review software or Case Review software (over Wi-Fi using ZOLL Online). Once you have transferred a configuration file to a USB flash drive you can copy it to other ZOLL AED 3 defibrillators. See “Importing Files from a USB Flash Drive” on page 16 for more information.

## Using RescueNet Code Review Software

RescueNet Code Review software allows you to analyze resuscitation incident information from the AED and perform the following functions:

- Access and review patient event information.
- Add or modify patient information.
- View animated versions of ECG traces.
- Annotate ECG traces.
- Print ECG stripcharts and case reports.

Visit [www.zolldata.com/c-r-downloads/](http://www.zolldata.com/c-r-downloads/) to download the latest version of RescueNet Code Review Software and corresponding documentation.

## Using Case Review Software

Case Review software is a cloud-based clinical data management and quality reporting system that is hosted in ZOLL Online. Using its Wi-Fi capability, the ZOLL AED 3 can be configured to transmit clinical event data over Wi-Fi to ZOLL Case Review. When using Case Review software to manage clinical event data, you can perform the following functions:

- Collect clinical files to a single destination.
- Make data easily available to a clinical quality team.
- Review quality of CPR directly from the web.
- View trends in CPR quality and data movement.

Visit [www.zollonline.com](http://www.zollonline.com) for more information.

## Importing Files from a USB Flash Drive

You can import a configuration file, a software upgrade, or a wireless configuration to an AED using a USB flash drive. You must have Supervisor access to import data files from a USB flash drive (see “Set Supervisor Passcode” on page 62 for more information).

**NOTE** When importing files via USB, the USB flash drive must be USB 1.1 or 2.0 compliant.

**NOTE** The AED does not allow you to perform a software upgrade when the battery is below 30% capacity.

---


You can import the following file types:

- Configuration— Allows to you import clinical or Wi-Fi configuration files. Before importing a configuration file, make sure the file name (.ini) does not have spaces in it.
- System Software— Allows you to upgrade to the latest software version.
- Root Certificates— Allows you to import Wi-Fi configuration files to validate the identity of the server and different elements in the network.

## Importing Files

Follow the steps below to import files from a USB flash drive to an AED.

**WARNING! Do not connect the AED to a computer or other device (via the USB port) while the AED's defibrillation pads are still connected to the patient.**

1. Insert the USB flash drive into the USB connector on the back of the AED.
2. Press and hold the On/Off button for more than 5 seconds. Once the USB flash drive has been detected, the USB device icon (  ) appears in the status bar at the bottom of the display screen.
3. Press the Device Configuration icon to enter AED Management mode.



Configuration  
Device  
icon



Supervisor  
Access icon



Import Files  
icon

4. Press the Supervisor Access icon, enter your supervisor passcode, and press **OK**.
5. Press the Import Files icon and select one the following options to import:
  - Configuration
  - System Software
  - Root Certificates

A green check displays next to the option you have selected.

6. See the table below to determine your next step based on the option you have selected:

Option	Do the following	Then
Configuration	Select the following option(s): <ul style="list-style-type: none"> <li>Clinical Configuration</li> <li>Wi-Fi Configuration</li> </ul>	Press <b>OK</b> . When the ZOLL AED 3 has finished transferring data, it issues the prompt, <i>FILES TRANSFERRED SUCCESSFULLY</i> .
System Software	Press <b>OK</b> . The AED issues the prompt: <i>UPON COMPLETION OF THE SOFTWARE UPGRADE THE SYSTEM WILL RESTART. THE SCREEN WILL GO BLANK DURING THIS PROCESS. THIS MAY TAKE UP TO 5 MINUTES. DO NOT POWER OFF DURING THIS TIME.</i>	
Root Certificates	Select a root certificate(s).	Press <b>OK</b> . When the AED has finished transferring data, it issues the prompt, <i>SELECTED CERTIFICATES SUCCESSFULLY STORED</i> .

7. Press **OK** to return to the previous screen.

## Troubleshooting Communication Issues

The following table summarizes communication messages that the ZOLL AED 3 defibrillator may issue, and their associated description and/or recommended action. If the AED is not working properly, contact ZOLL's Technical Service Department for assistance. See "Technical Service" on page ix for more information.

**Table 3. ZOLL AED 3 Communication Error Messages**

Message	Description/Recommended Action
<i>DATA TRANSFER COMPLETE</i>	The data transfer through Wi-Fi is complete.
<i>UNABLE TO SAVE FILES. PLEASE ENSURE THAT AN EMPTY USB FLASH DRIVE IS SECURELY INSERTED INTO THE DEVICE.</i>	The AED cannot save the files to the USB flash drive. Verify that there is sufficient space to export the file(s) to the USB flash drive, and that the flash drive is inserted properly into the unit.
<i>UNABLE TO SAVE FILE TO DEVICE.</i>	The file import was not successful. Make sure there is a configuration file (.ini) on the USB flash drive and try the file import operation again.
<i>FILES TRANSFERRED SUCCESSFULLY.</i>	The file(s) has been successfully imported from the USB flash drive.
<i>UNABLE TO EXPORT REQUESTED FILE. INTERNAL ERROR.</i>	The file export was not successful. Verify the Wi-Fi configuration and try the export operation again.
<i>NO CERTIFICATES FOUND.</i>	There are no root certificates on the USB flash drive available to import.

<b>Message</b>	<b>Description/Recommended Action</b>
<i>SELECTED CERTIFICATES SUCCESSFULLY STORED.</i>	The root certificates have been imported to the AED.
<i>YOU HAVEN'T SELECTED ANY FILES.</i>	You have not selected any files to be imported. Select the file(s) and try the import operation again.
<i>CLINICAL ARCHIVE UNAVAILABLE.</i>	There are no clinical archive files (.crd) available to export.
<i>DEVICE HISTORY UNAVAILABLE.</i>	There are no device history files (.dhf) available to export.
<i>CONFIGURATION FILES UNAVAILABLE.</i>	There are no configuration files (.ini) available to export.
<i>THE REQUESTED FILE IS OUT OF DATE. UNABLE TO IMPORT.</i>	The AED cannot import the configuration file (.ini) from the USB flash drive. Verify that the file is a compatible version and try the import operation again.
<i>THE REQUESTED FILE CONTAINS INVALID DATA. UNABLE TO IMPORT.</i>	The AED cannot import the file from the USB flash drive. Verify that the file is valid and try the import operation again.
<i>THE REQUESTED FILE IS CORRUPTED. UNABLE TO IMPORT.</i>	The AED cannot import the file from the USB flash drive. Verify that the file is valid and try the import operation again.
<i>THE REQUESTED FILE CANNOT BE FOUND. VERIFY THAT THE USB FLASH DRIVE CONTAINS THE NECESSARY FILE AND THAT THE USB FLASH DRIVE IS PROPERLY INSERTED IN THE DEVICE.</i>	The AED cannot read the USB flash drive. Verify that the USB flash drive is inserted properly into the unit.
<i>CONFIGURATION FILES ARE ONLY SAVED TO USB. THEY ARE NOT TRANSMITTED VIA WI-FI.</i>	The AED cannot transmit configuration files through Wi-Fi.
<i>WI-FI CONNECTION NOT ESTABLISHED. CANNOT TRANSMIT REQUESTED DATA.</i>	The AED cannot transmit the data through the Wi-Fi connection. If you have not already done so, see "Setting Up Your Wireless Configuration" on page 65.
<i>THE SYSTEM IS UNABLE TO INSTALL THE SELECTED CERTIFICATES. PLEASE ENSURE THAT THE USB FLASH DRIVE IS PROPERLY INSERTED.</i>	The AED cannot save the files to the USB flash drive. Verify that the USB flash drive is inserted properly into the device.
<i>UNABLE TO TRANSMIT REQUESTED FILE.</i>	The attempt to export the file to the USB flash drive was unsuccessful. Try the file transfer again.

---

Message	Description/Recommended Action
<i>UPON COMPLETION OF THE SOFTWARE UPGRADE THE SYSTEM WILL RESTART. THE SCREEN WILL GO BLANK DURING THIS PROCESS. THIS MAY TAKE UP TO 5 MINUTES. <b>DO NOT POWER OFF DURING THIS TIME.</b></i>	AED is performing a software upgrade. Wait until the upgrade is complete and the unit restarts.



# Chapter 3

## Maintenance

The ZOLL AED 3 defibrillator automatically performs functional testing during periodic self tests. There are also some basic maintenance tests that can be performed on the AED. This section of the guide contains information about functions that are performed with each self test as well as procedures for maintaining the ZOLL AED 3 device.

### Self Tests

The ZOLL AED 3 defibrillator performs the following self tests to verify AED integrity and its readiness for emergency use:

- Battery Installation
- Power On
- Manual
- Automatic (daily or weekly, based on configuration)
- Automatic Monthly



Following successful completion of all self tests, the status indicator displays a green check (✓) to show that all tests passed and that the AED is ready to use.



If the status indicator is blank following completion of any self test, the ZOLL AED 3 defibrillator is not ready for use and may be defective. Remove the AED from service and consult the section, “Chapter 4 Troubleshooting” on page 29, to help determine the problem.

## Self Test Functions

The following functions are verified during self tests. Table 4 on page 23 lists the functions that are included in each self test.

- **Battery Capacity:** Verifies that the battery usage indicator shows adequate battery capacity remaining.
- **Defibrillation Pads Connection:** Verifies that the defibrillation pads are properly preconnected to the device.
- **Defibrillation Pads/Battery Expiration:** Verifies that the defibrillation pads and the battery are within their expiration dates.
- **ECG Circuitry:** Tests that the ECG signal acquisition and processing electronics are functional.
- **Defibrillator Charge and Discharge Circuitry:** Verifies that the device’s defibrillator electronics are functional and can charge and discharge at 2 joules. The following tests also include a separate 200 joule charge/discharge test: Battery Installation Self Test, Manual Self Test, Automatic Monthly Test.
- **Microprocessor Hardware/Software:** Verifies proper function of the AED microprocessor electronics and the integrity of its software.
- **CPR Circuitry and Sensor:** Determines that CPR monitoring and compression depth detection are functional (if defibrillation pads with CPR functionality are connected).
- **Audio Circuitry:** Verifies that voice prompts are working.

### Automatic Self-Test Transfer

All ZOLL AED 3 defibrillators come standard with Program Management Onboard™ intelligent monitoring technology to transfer self-test data. If configured, the AED can automatically transfer self-test information over Wi-Fi to the ZOLL PlusTrac™ AED program management system or to another AED program management provider.

**Table 4. Self Test Functions**

	<b>Battery Installation Self Test</b>	<b>Power On Self Test</b>	<b>Manual Self Test</b>	<b>Automatic Self Test</b>	<b>Automatic Monthly Test</b>
Battery Capacity	✓	✓	✓	✓	✓
Defibrillation Pads Connection	✓	✓	✓	✓	✓
Defibrillation Pads/ Battery Expiration	✓	✓	✓	✓	✓
ECG Circuitry	✓	✓	✓	✓	✓
Defibrillator Charge and Discharge Circuitry (2 Joule Charge/ Discharge Test)	✓	✓	✓	✓	✓
Microprocessor Hardware/Software	✓	✓	✓	✓	✓
CPR Circuitry and Sensor (if defibrillation pads with CPR functionality are connected)	✓	✓	✓	✓	✓
Audio Circuitry	✓	✓	✓	✓	✓
200 Joule Charge/ Discharge Test	✓		✓		✓

---

## Optional Maintenance Tests

This section includes a physical inspection of the ZOLL AED 3 defibrillator that you should perform periodically. There is also an optional maintenance test for ZOLL AED 3 models to verify that the AED is working properly and is ready for use. Note that there are two separate optional maintenance tests in this chapter: One for ZOLL AED 3 and ZOLL AED 3 *BLS* models, and one for the ZOLL AED 3 *Automatic* model.

### Physical Inspection

Check the following:	
1.	Is the AED clean, undamaged, free of excessive wear?
2.	Verify that the defibrillation pads are connected to the AED and sealed in their package. Replace defibrillation pads if expired.
3.	Are there any cracks or loose parts in the housing?
4.	Turn on the AED and verify the green check (✓) indicates ready for use; then turn it off.

### Cleaning the ZOLL AED 3 Defibrillator

After each use, clean and disinfect the defibrillator with a soft, damp cloth using either 90% isopropyl alcohol, or soap and water. You can also use a chlorine bleach and water mixture (30 ml/liter water) to clean the defibrillator (except on the contacts and connectors).

**NOTE** Wipe down the defibrillator with water after using any cleaning solution. Chlorine residue that remains on the LCD screen may damage it.

DO NOT:

- Immerse any part of the defibrillator in water.
- Use chlorine mixture on contacts or connectors; this will degrade the contacts over time.
- Use ketones (MEK, acetone, etc.) to clean the defibrillator.
- Use abrasives (e.g., paper towel) on the display window or graphic screen.
- Sterilize the defibrillator.

---

## Optional Maintenance Test for Technical Professionals

Although the ZOLL AED 3 automatically performs maintenance testing during periodic self tests, you can periodically perform the following manual test to verify that the ZOLL AED 3 is working properly and is ready for use.

This section has two tests: one for ZOLL AED 3 and ZOLL AED 3 *BLS* models, and one for ZOLL AED 3 *Automatic* models.

### Test Procedure (ZOLL AED 3 and ZOLL AED 3 *BLS* Models)

**NOTE** You must use the ZOLL AED Simulator with this test.

1. Connect the ZOLL AED Simulator to the ZOLL AED 3 defibrillation pads connector.
2. Power on the simulator and the ZOLL AED 3 defibrillator. Verify that all of the following occur:
  - The status indicator (located on the top left of the AED) initially changes from blank to a green check (✓) within 4 to 5 seconds after the AED is turned on.
  - The AED issues the *UNIT OK* voice prompt and displays the message within 5 seconds after power-up.
  - The AED displays the number of shocks in the bottom left of the screen and the event elapsed time (since power-up) in the bottom right of the LCD screen.
3. Using the simulator, input a VF rhythm to the AED. Verify that after the AED proceeds through its sequence of victim assessment prompts, it does the following:
  - Analyzes the ECG rhythm.
  - Issues the *SHOCK ADVISED* voice prompt.
  - Charges the defibrillator.
  - Issues the *DON'T TOUCH THE PATIENT; PRESS THE FLASHING SHOCK BUTTON* voice prompt.
4. Verify that the AED emits the charge ready tone and that the Shock button illuminates.
5. Press the Shock button and verify that the simulator shows that a shock was delivered. Verify that the number 1 displays next to the shock icon on the bottom left of the LCD screen.
6. Following shock delivery, verify that the AED issues the *START CPR* messages.
7. Activate the simulator's CPR function. Verify that the metronome begins to beep and that the following voice prompts/messages are issued within 60 seconds: *PUSH HARDER* followed by *GOOD COMPRESSIONS*.

- 
8. After approximately two minutes of CPR, verify that the *STOP CPR* prompt is issued. Set the simulator to Normal Sinus Rhythm (NSR) and verify that a new ECG analysis begins.
  9. Verify that a *NO SHOCK ADVISED* prompt is issued.
  10. Turn off the ZOLL AED 3 defibrillator and the simulator.

### **Test Procedure (ZOLL AED 3 Automatic Models)**

**NOTE** You must use the ZOLL AED Simulator with this test.

1. Connect the ZOLL AED Simulator to the ZOLL AED 3 defibrillation pads connector.
2. Power on the simulator and the ZOLL AED 3 defibrillator. Verify that all of the following occur:
  - The status indicator (located on the top left of the AED) initially changes from blank to a green check (✓) within 4 to 5 seconds after the AED is turned on.
  - The AED issues the *UNIT OK* voice prompt and displays the message within 5 seconds after power-up.
  - The AED displays the number of shocks in the bottom left of the screen and the event elapsed time (since power-up) in the bottom right of the LCD screen.
3. Using the simulator, input a VF rhythm to the AED. Verify that after the AED proceeds through its sequence of victim assessment prompts, it does the following:
  - Analyzes the ECG rhythm.
  - Issues the *SHOCK ADVISED* voice prompt.
  - Charges the defibrillator.
  - Issues the *DON'T TOUCH THE PATIENT; SHOCK WILL BE DELIVERED IN THREE, TWO, ONE* voice prompt.
4. Verify that the AED emits the charge ready tone and the AED automatically delivers a shock.
5. Following shock delivery, verify the following:
  - The AED issues the *SHOCK DELIVERED* message.
  - The simulator shows that a shock was delivered.
  - The number 1 displays next to the shock icon on the bottom left of the AED LCD screen.
  - The AED issues the *START CPR* messages.
6. Activate the simulator's CPR function. Verify that the metronome begins to beep and that the following voice prompts/messages are issued within 60 seconds: *PUSH HARDER* followed by *GOOD COMPRESSIONS*.
7. After approximately two minutes of CPR, verify that the *STOP CPR* prompt is issued. Set the simulator to Normal Sinus Rhythm (NSR) and verify that a new ECG analysis begins.

8. Verify that a *NO SHOCK ADVISED* prompt is issued.
9. Turn off the ZOLL AED 3 defibrillator and the simulator.

## Battery Maintenance

### Identifying Battery Conditions

Battery capacity depletes during standby operation of the ZOLL AED 3 defibrillator, while the AED is operating, and as a result of each defibrillation. Battery capacity also gradually diminishes over a shelf life of years without use. The AED monitors energy remaining in the installed battery pack. When battery capacity is low or depleted, the ZOLL AED 3 defibrillator will not function to specification. When a low battery condition occurs, the AED does one of the following things:

- Emits an audible alarm or “beep” once every minute (if the AED is off).
- Issues the *CHANGE BATTERY* voice prompt (if the AED is on).
- Displays a blank status indicator window (no green check), indicating that the battery is at low capacity or that the ZOLL AED 3 defibrillator has failed other self tests.

**Table 5. Battery Conditions**

Battery Icon/ Condition	Indications	Correction
Low Battery with AED off.	Audible beep from AED once every minute.	Replace battery pack.
Low Battery during power up self test.	<i>CHANGE BATTERY</i> prompt (when AED is powered on)	Replace battery pack.
Low Battery or other self test failure with AED powered off or during self test.	Status Indicator window is blank (no green check) indicating failure to operate (when off).	Replace battery pack. Check or replace defibrillation pads. If blank status indicator window remains, contact ZOLL Technical Service Department for service.
Low Battery with AED powered on.	<i>CHANGE BATTERY</i> prompt (AED powered on).	Replace battery pack as soon as possible.
Dead Battery.	Status indicator window is blank (no green check) indicating failure to operate when AED is off.	Replace battery pack. If blank status indicator window remains, contact ZOLL Technical Service Department for service.





# Chapter 4

## Troubleshooting

This chapter describes technical issues that you may encounter during routine maintenance or after a malfunction of the ZOLL AED 3 defibrillator.

If this chapter does not help you resolve the problem, call the ZOLL Technical Service Department for assistance. For contact information, refer to page ix.

### **Troubleshooting the AED**

The following table lists issues that may occur and their solutions. First, try the recommendations listed under “Operator Action.” If these steps do not remedy the problem, follow the suggestions under “Technical Action.”

For information on contacting ZOLL Technical Service, refer to page ix.

**Table 6. ZOLL AED 3 Troubleshooting**

<b>Problem</b>	<b>Operator Action</b>	<b>Technical Action</b>
Green check does not appear in status indicator window.	Press and hold the <b>On/Off</b> button for at least 5 seconds to perform a self-test. Verify that the defibrillation pads cable is properly plugged into the patient cable connector. Replace the defibrillation pads.	If the AED continues to fail, remove it from service and contact ZOLL Technical Service.
<i>UNIT FAILED</i>	Turn the AED off and then press and hold the <b>On/Off</b> button for at least 5 seconds to perform a self-test. Verify that the defibrillation pads cable is properly plugged into the patient cable connector. Replace the defibrillation pads.	If the AED continues to fail, remove it from service and contact ZOLL Technical Service.
Beeping noise when AED is off.	Verify that the defibrillation pads cable is properly plugged into the patient cable connector. Hold the <b>On/Off</b> button for at least 5 seconds to perform a self-test. Verify that a green check appears in the status indicator window.	If the AED continues to beep, remove it from service and contact ZOLL Technical Service.
Loss of audio prompts or display.	Cycle power on the defibrillator by turning the AED off, and then on again.	If the AED continues to fail, remove the AED from service and contact ZOLL Technical Service.
<i>CHANGE BATTERY</i>	Replace the battery pack.	If the message persists, remove the AED from service and contact ZOLL Technical Service.
<i>PLUG IN PADS CABLE</i>	Ensure that the defibrillation pads cable is properly plugged into the patient cable connector.	If the message persists, remove the AED from service and contact ZOLL Technical Service.
<i>CHECK PADS</i>	Reattach pads.	If the message persists, attach new pads.
<i>ANALYSIS HALTED; KEEP PATIENT STILL</i>	Keep the patient still during ECG analysis. If transporting the patient by stretcher or vehicle, stop all patient movement during analysis.	If the message persists, remove the AED from service and contact ZOLL Technical Service.

**Table 6. ZOLL AED 3 Troubleshooting (Continued)**

<b>Problem</b>	<b>Operator Action</b>	<b>Technical Action</b>
<i>NO SHOCK DELIVERED</i>	The Shock button was not pressed or an internal error occurred. When prompted to press the button, do so within 30 seconds.	If an internal error occurred (no shock was delivered when the Shock button was pressed properly), remove the AED from service and contact ZOLL Technical Service.
<i>RELEASE SHOCK BUTTON</i>	(ZOLL AED 3 and ZOLL AED 3 BLS models) Release the Shock button. Do not press the button until the charge-ready tone sounds and the button begins flashing.	If the message persists, remove the AED from service and contact ZOLL Technical Service.
<i>ATTACH CORRECT DEFIB PADS</i>	Attach one of the following compatible defibrillation pads to the AED: <ul style="list-style-type: none"><li>• CPR-D padz</li><li>• CPR Stat padz</li><li>• Pedi-Padz II (child pads)</li><li>• Stat-padz II</li></ul>	If the message persists, remove the AED from service and contact ZOLL Technical Service.
<i>REPLACE PADS</i>	Attach new defibrillation pads to the AED.	If the message persists, remove the AED from service and contact ZOLL Technical Service.









# Appendix A


## Symbols













### Symbols

Any or all of the following symbols may be used in this guide or on this equipment:

**Table 7: Symbols**

Symbol	Description
	Power On/Off.
	Child button.
	Shock button.
	Warning: Dangerous voltage.
	Fragile, handle with care.
	Keep dry.

Symbol	Description
	This end up.
	Temperature limitation.
<b>Rx ONLY</b>	Federal law restricts this device to sale by or on the order of a physician.
<b>CE</b>	<b>Conformité Européenne</b> Complies with medical device directive 93/42/EEC.
	This product has been certified by the Australian Communication and Media Authority.
<b>FC</b>	Complies with the Federal Communications Commission.
	Defibrillator-proof type BF equipment.
	Contains lithium. Recycle or dispose of properly.
	Keep away from open flame and high heat.
	Do not open, disassemble, or intentionally damage.
	Do not crush.
	Non-rechargeable battery.
	Return to a collection site intended for waste electrical and electronic equipment (WEEE). Do not dispose of in unsorted trash.
	Use by.
	Latex-free.

Symbol	Description
	Do not reuse.
	Not sterile.
	Nonionizing electromagnetic radiation.
	Manufacturer.
	Authorized representative in the European Community.
	Serial Number.
	Catalog number.
	MR Unsafe - keep away from magnetic resonance imaging (MRI) equipment.
	Batch code.
	Consult instructions for use.
	Refer to manual.
	Use by date.
<b>IP55</b>	Protected against dust ingress. Protected against jetting water.





# Appendix B

## Specifications

### Defibrillator Specifications

This section describes product specifications for the ZOLL AED 3 defibrillator:

Device	
Size (H x W x D)	5.0" x 9.3" x 9.7" (12.7 cm x 23.6 cm x 24.7 cm)
Weight	5.5 lbs.; 2.5 kg
Power	Battery pack
Device Classification	Internally powered per EN60601-1
Design Standards	Meets applicable requirements of EN 60601-1, IEC 60601-1-11, EN 60601-2-4
Environment	
Operating Temperature	32° to 122° F; 0° to 50° C
Storage Temperature	-22° to 158° F; -30° to 70° C
Humidity	10 to 95% relative humidity, non-condensing
Vibration	IEC 60068-2-64, Random, Spectrum A.4, Table A.8, Cat. 3b; RTCA/DO-160G, Fixed Wing Aircraft, Section 8.6, Test Cat. H, Aircraft Zone 1 and 2; EN 1789, Sweep per EN 60068-2-6 Test Fc
Shock	IEC 60068-2-27; 100G
Altitude	-1,250 to 15,000 ft.; -381 m to 4573 m
Particle and Water Ingress	IP55
Drop	3.28 ft; 1 m

---

**Defibrillator**

Waveform	Rectilinear Biphasic™  Refer to “Rectilinear Biphasic Waveform Characteristics” on page 44 and “Clinical Trial Results for the M Series Biphasic Waveform” on page 49.
Defibrillator Charge Hold Time	ZOLL AED 3/ZOLL AED 3 <i>BLS</i> models: 30 seconds ZOLL AED 3 <i>Automatic</i> model: 3 seconds prior to automatic shock delivery
Energy Selection	Automatic pre-programmed selection (Adult mode: 120J, 150J, 200J; Child mode: 50J, 70J, 85J delivered into a 50 ohm patient)
Patient Safety	All patient connections are electrically isolated.
Charge Time	Less than 10 seconds with new battery pack. With a depleted battery pack, the charge time is longer.
Time from first rhythm analysis to AED charged and ready to shock	With new battery pack: 8 seconds With battery pack depleted by 15 200J discharges: 9 seconds
Maximum time from power on to AED charged and ready to shock at 200J	36 seconds
Electrodes	CPR-D padz, CPR Stat-padz, Stat-padz II, or Pedi-padz II
Built in Defibrillator Self Test	Included (verifies proper charging and discharging of the defibrillator)
Defibrillation Advisory	Evaluates defibrillation pad connection and patient ECG to determine if defibrillation is required.
Shockable Rhythms	Ventricular fibrillation with average amplitude >100 microvolts and wide complex ventricular tachycardia (with QRS duration > 120 msec) with rates greater than 150 BPM (adult mode) and 200 BPM (child mode).  Refer to “ECG Analysis Algorithm Accuracy” on page 53 for sensitivity and specificity performance.
Electrode Patient Impedance Measurement Range	10 to 300 ohms
Defibrillator Electrode ECG Circuitry	Protected
<b>ECG</b>	
ECG Bandwidth	.67-20Hz
Implanted Pacemaker Pulses Detected	The ZOLL AED 3 defibrillator does not reject implanted pacemaker pulses.

<b>Display</b>							
Display type	High resolution liquid crystal display with capacitive touch panel						
Viewable area (height • width)	2.12 in • 3.74 in 5.39 cm • 9.5 cm						
ECG Sweep Speed	25 mm/sec						
ECG Viewing time	3.84 seconds						
<b>Data Recording and Storage</b>							
ZOLL AED 3/ ZOLL AED 3 <i>Automatic</i>	User configurable for 1 or 2 clinical events for a total of 120 minutes. Includes, ECG, patient impedance, audio prompts, and CPR data.						
ZOLL AED <i>BLS</i>	User configurable for 1 or 2 clinical events for a total for 120 minutes with audio recording disabled, or 60 minutes with audio recording enabled. Includes ECG, patient impedance, audio prompts, CPR data, and optional audio recording.						
<b>Battery</b>							
Operating Time (Clinical Mode)	<p>Typical new battery running at an ambient temperature of +20° C to +25° C (68° F to 77° F) can provide:</p> <ul style="list-style-type: none"> <li>• 140 defibrillator discharges at maximum energy (200 joules), or</li> <li>• 6 hours of continuous monitoring (with 2-minute CPR periods)</li> </ul> <p><b>Note:</b> CPR periods shorter than 2 minutes can decrease the operating time that can be obtained from a new battery.</p>						
<b>Standby Life (years)</b> When using a battery stored for up to 2 years at 23° C (73° F) and placed in a ZOLL AED 3 defibrillator.	<p><b>Auto Self-Test Report OFF</b></p> <table border="0"> <tr> <td><b>Self-Test Interval (7 days)</b></td> <td>5</td> </tr> <tr> <td><b>Self-Test Interval (1 day)</b></td> <td>3</td> </tr> </table> <p><b>Auto Self-Test Report ON</b></p> <table border="0"> <tr> <td><b>Self-Test Interval (7 days)</b></td> <td>3*</td> </tr> </table>	<b>Self-Test Interval (7 days)</b>	5	<b>Self-Test Interval (1 day)</b>	3	<b>Self-Test Interval (7 days)</b>	3*
<b>Self-Test Interval (7 days)</b>	5						
<b>Self-Test Interval (1 day)</b>	3						
<b>Self-Test Interval (7 days)</b>	3*						
*Battery standby life will be shorter in areas with low Wi-Fi signal strength and/or more complex Wi-Fi authentication protocols.							
<b>CPR Monitoring</b>							
CPR	Metronome Rate: 105 ±2 CPM						
Compression Depth	0.75 to 4 inches ±0.25 inches 1.9 to 10.2 cm ±0.6 cm						
Compression Rate	50 to 150 compressions per minute						

---

## Guidance and Manufacturer's Declaration - Electromagnetic Compatibility

The ZOLL AED 3 defibrillator is intended for use in the electromagnetic environment specified below. The customer or the user of the AED should assure that it is used in such an environment.


Emissions test	Compliance	Electromagnetic environment - guidance
RF emissions CISPR11	Group 1	The ZOLL AED 3 uses RF energy only for its internal function. Therefore, its RF emissions are very low and are not likely to cause any interference in nearby electronic equipment.
RF emissions CISPR 11	Class B	The ZOLL AED 3 is suitable for use in all establishments, including domestic establishments and those directly connected to the public low voltage power supply network that supplies buildings used for domestic purposes.
Harmonic Emission IEC 61000 3-2	Not applicable	
Voltage Fluctuations/ Flicker Emission IEC 61000 3-3	Not applicable	

Medical Electrical Equipment needs special precautions regarding EMC and needs to be installed and put into service according to EMC information provided in this document.

The ZOLL AED 3 defibrillator's essential performance is energy delivery, ECG rhythm analysis, and CPR feedback, as specified on page 37 to page 39. The ZOLL AED 3 defibrillator meets basic safety and essential performance when it is operated in the electromagnetic environment specified in the following tables.

The ZOLL AED 3 defibrillator is intended for use in the electromagnetic environment specified below. The customer or the user of the AED should assure that it is used in such an environment.

Immunity test	IEC 60601 test level	Compliance level	Electromagnetic environment - guidance
Electrostatic discharge (ESD) IEC 61000-4-2	± 8 kV contact ± 15 kV air	± 8 kV contact ± 15 kV air	The relative humidity should be at least 5%.
Electrical fast transient/burst IEC 61000-4-4	± 2 kV for power supply lines ± 1 kV for input/output lines	Not applicable Not applicable	
Surge IEC 61000-4-5	± 1 kV differential mode +/- 2 kV common mode	Not applicable Not applicable	
Voltage dips, short interruptions and voltage variations on power supply input lines. IEC 61000-4-11	<5% $U_T$ (>95% dip in $U_T$ ) for 0.5 cycle 40% $U_T$ (60% dip in $U_T$ ) for 5 cycles 70% $U_T$ (30% dip in $U_T$ ) for 25 cycles <5% $U_T$ (>95% dip in $U_T$ ) for 5 sec	Not applicable Not applicable Not applicable Not applicable	
Power frequency (50/60 Hz) magnetic field IEC 61000-4-8	30 A/m	30 A/m	Power frequency magnetic fields should be at levels characteristic of a typical location in a typical commercial or hospital environment.
			Portable and mobile RF communications equipment should be used no closer to any part of the AED, including cables, than the recommended separation distance calculated from the equation applicable to the frequency of the transmitter, or 30 cm, whichever is greater.
<b>Recommended separation distance</b>			
Conducted RF IEC 61000-4-6	3 Vrms 150 kHz to 80 MHz outside ISM bands <sup>a</sup>	3 Vrms	$d = 1.2 \sqrt{P}$ outside ISM bands
	10 Vrms 150 kHz to 80 MHz in ISM bands <sup>a</sup>	10 Vrms	$d = 1.2 \sqrt{P}$ within ISM bands

Immunity test (cont'd)	IEC 60601 test level (cont'd)	Compliance level (cont'd)	Electromagnetic environment - guidance (cont'd)
Radiated RF IEC 61000-4-3	10 V/m 80 MHz to 2.5 GHz	10 V/m	Recommended separation distance
			$d = 1.2 \sqrt{P}$ 80 MHz to 800 MHz $d = 2.3 \sqrt{P}$ 800 MHz to 2.5 GHz where $P$ is the maximum output power rating of the transmitter in watts (W) according to the transmitter manufacturer and $d$ is the recommended separation distance in metres (m). <sup>b</sup> Field strengths from fixed RF transmitters, as determined by an electromagnetic site survey, <sup>c</sup> should be less than the compliance level in each frequency range. <sup>d</sup> Interference may occur in the vicinity of equipment marked with the following symbol: 

The ZOLL AED 3 defibrillator is suitable for use in all professional and domestic establishments. It is not intended for use near intentional transmitters of radio energy outside the ranges stated in the above table, such as high frequency surgical equipment, radar installations, or radio transmitters. It is also not intended for use in fixed or rotary wing aircraft.

The ZOLL AED 3 defibrillator is MR unsafe. Keep the defibrillator away from magnetic resonance imaging (MRI) equipment.

Operation outside of this environment could result in the misinterpretation of the ECG rhythms or CPR signals, interference to the display or audio messages, or the inability to provide defibrillation therapy.

Adverse effects of ESD may include loss of audio prompts or visual display. See "Chapter 4 Troubleshooting" on page 29 for more information.

**NOTE 1:**  $U_T$  is the a.c. mains voltage prior to application of the test level.

**NOTE 2:** At 80 MHz, the higher frequency range applies.

**NOTE 3:** These guidelines may not apply in all situations. Electromagnetic propagation is affected by absorption and reflection from structures, objects and people.

<sup>a</sup> The ISM (industrial, scientific and medical) bands between 150 kHz and 80 MHz are 6.765 MHz to 6.795 MHz; 13.553 MHz to 13.567 MHz; 26.957 MHz to 27.283 MHz; and 40.66 MHz to 40.70 MHz.

<sup>b</sup> The compliance levels in the ISM frequency bands between 150 kHz and 80 MHz and in the frequency range 80 MHz to 2.5 GHz are intended to decrease the likelihood that mobile/portable communications equipment could cause interference if it is inadvertently brought into patient areas. For this reason, an additional factor of 10/3 is used in calculating the recommended separation distance for transmitters in these frequency ranges.

<sup>c</sup> Field strengths from fixed transmitters, such as base stations for radio (cellular/cordless) telephones and land mobile radios, amateur radio, AM and FM radio broadcast and TV broadcast cannot be predicted theoretically with accuracy. To assess the electromagnetic environment due to fixed RF transmitters, an electromagnetic site survey should be considered. If the measured field strength in the location in which the AED is used exceeds the applicable RF compliance level above, the ZOLL AED 3 defibrillator should be observed to verify normal operation. If abnormal performance is observed, additional measures may be necessary, such as reorienting or relocating the AED.

<sup>d</sup> Over the frequency range 150 kHz to 80 MHz, field strengths should be less than 10 V/m.

---

**Recommended separation distances between portable and mobile RF communications equipment and the ZOLL AED 3 defibrillator**

The ZOLL AED 3 is intended for use in an environment in which radiated RF disturbances are controlled. The customer or the user of the ZOLL AED 3 can help prevent electromagnetic interference by maintaining a minimum distance between portable and mobile RF communications equipment (transmitters) and the ZOLL AED 3 as recommended below, according to the maximum output power of the communications equipment.

The recommended separation distance should be the distance calculated from one of the equations below, or 30 cm, whichever is greater.

Rated maximum output power of transmitter in watts (W)	Separation distance in meters (m) according to frequency of transmitter			
	150 kHz to 80 MHz outside ISM bands $d = 1.2 \sqrt{P}$	150 kHz to 80 MHz in ISM bands $d = 1.2 \sqrt{P}$	80 MHz to 800 MHz $d = 1.2 \sqrt{P}$	800MHz to 2.5 GHz $d = 2.3 \sqrt{P}$
0.01	0.12	0.12	0.12	0.23
0.1	0.38	0.38	0.38	0.73
1	1.2	1.2	1.2	2.3
10	3.8	3.8	3.8	7.3
100	12	12	12	23

For transmitters rated at a maximum output power not listed above, the recommended separation distance  $d$  in metres (m) can be determined using the equation applicable to the frequency of the transmitter, where  $P$  is the maximum output power rating of the transmitter in watts (W) according to the transmitter manufacturer.

**NOTE 1:** At 80 MHz and 800 MHz, the separation distance for the higher frequency range applies.

**NOTE 2:** The ISM (industrial, scientific and medical) bands between 150 kHz and 80 MHz are 6.765 MHz to 6.795 MHz; 13.553 MHz to 13.567 MHz; 26.957 MHz to 27.283 MHz; and 40.66 MHz to 40.70 MHz.

**NOTE 3:** An additional factor of 10/3 is used in calculating the recommended separation distance for transmitters in the ISM frequency bands between 150 kHz and 80 MHz and in the frequency range 80 MHz to 2.5 GHz to decrease the likelihood that mobile/portable communications equipment could cause interference if it is inadvertently brought into patient areas.

**NOTE 4:** These guidelines may not apply in all situations. Electromagnetic propagation is affected by absorption and reflection from structures, objects and people.

---

**NOTE** The ZOLL AED 3 incorporates RF receivers for Wi-Fi operation (see “Wireless Output Guidance and Manufacturer’s Declaration” on page 56). Other equipment may interfere with ZOLL AED 3 Wi-Fi operations, even if that equipment complies with CISPR emissions requirements.

---

# Rectilinear Biphasic Waveform Characteristics

The following table shows the Rectilinear Biphasic waveform's characteristics when discharged into 25 ohm, 50 ohm, 100 ohm, and 125 ohm loads at a maximum energy setting of 200 joules.

	Discharged into 25 ohm load	Discharged into 50 ohm load	Discharged into 100 ohm load	Discharged into 125 ohm load
First Phase Maximum Initial Current	29 A	27 A	20 A	16 A
First Phase Average Current	26 A	24 A	16 A	13 A
First Phase Duration	6 ms	6 ms	6 ms	6 ms
Interphase duration between first and second phases	150 μsec	150 μsec	150 μsec	150 μsec
Second Phase Maximum Initial Current	30 A	19 A	12 A	11 A
Second Phase Average Current	18 A	14 A	10 A	9 A
Second Phase Duration	4 ms	4 ms	4 ms	4 ms



---

**Table 8. Delivered Energy at Each Defibrillator Setting into a Range of Loads**

Load	Selected Energy					
	50 J	70 J	85 J	120 J	150 J	200 J
25Ω	37 J	54 J	57 J	86 J	109 J	139 J
50Ω	50 J	69 J	80 J	118 J	145 J	209 J
75Ω	61 J	82 J	97 J	134 J	166 J	196 J
100Ω	60 J	84 J	95 J	142 J	165 J	194 J
125Ω	57 J	80 J	91 J	133 J	155 J	178 J
150Ω	65 J	91 J	103 J	124 J	145 J	192 J
175Ω	60 J	84 J	95 J	116 J	135 J	177 J
Accuracy	±15%	±15%	±15%	±15%	±15%	±15%

The efficacy of ZOLL's Rectilinear Biphasic Waveform has been clinically verified during a Ventricular Fibrillation (VF) and Ventricular Tachycardia (VT) defibrillation study. This study (which was conducted using ZOLL M Series<sup>®</sup> defibrillators) and the findings are described below. Since the ZOLL AED 3 defibrillator's Rectilinear Biphasic Waveform employs the same first and second phase timing, similar first and second phase currents/voltages and essentially the same mechanisms for controlling defibrillation waveshape, the ZOLL M Series and ZOLL AED 3 defibrillation waveforms are considered substantially equivalent.

Figures 1 through 6 show the Rectilinear Biphasic waveforms that are produced when the ZOLL AED 3 defibrillator is discharged into loads of 25, 50, 75, 100, 125, 150, and 175 ohms at each energy setting (200, 150, 120, 85, 70, and 50 joules).

The vertical axis shows the current in amperes (A); the horizontal axis shows the duration in milliseconds (ms).

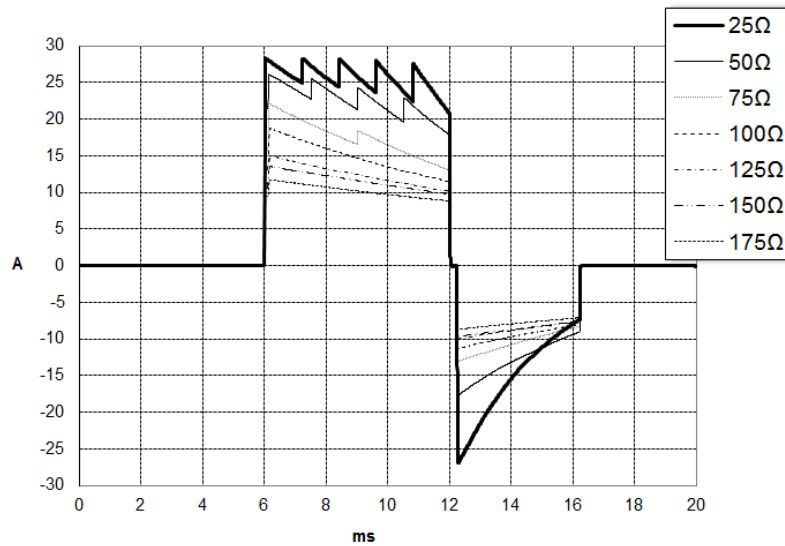


Figure 1. Rectilinear Biphasic Waveforms at 200 Joules

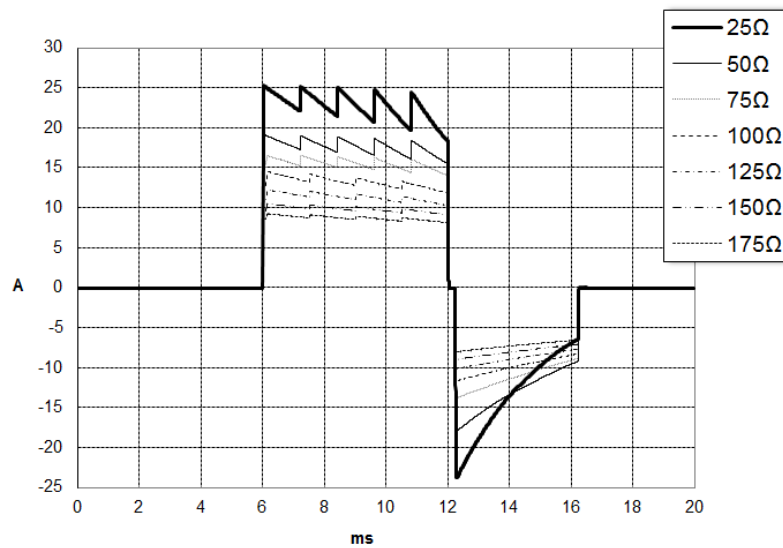
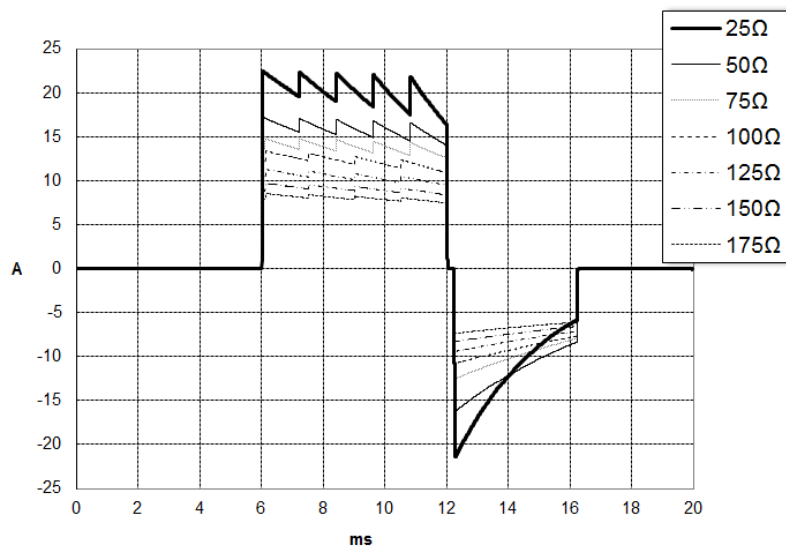
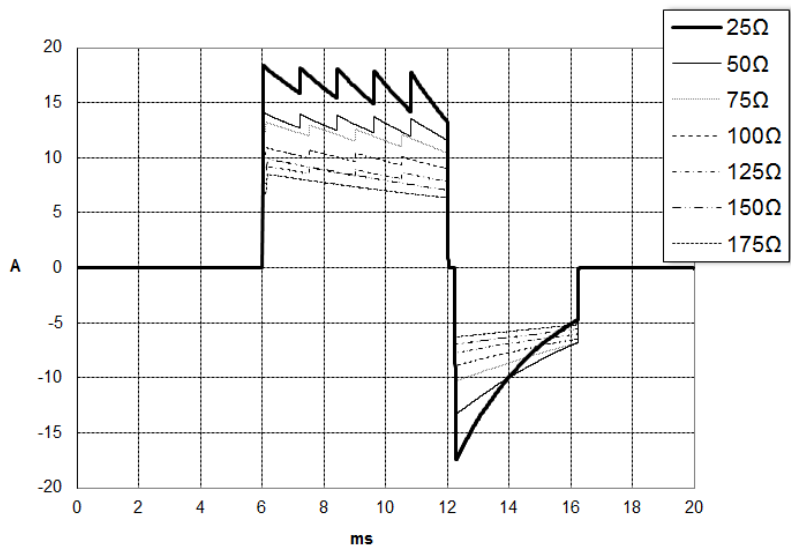


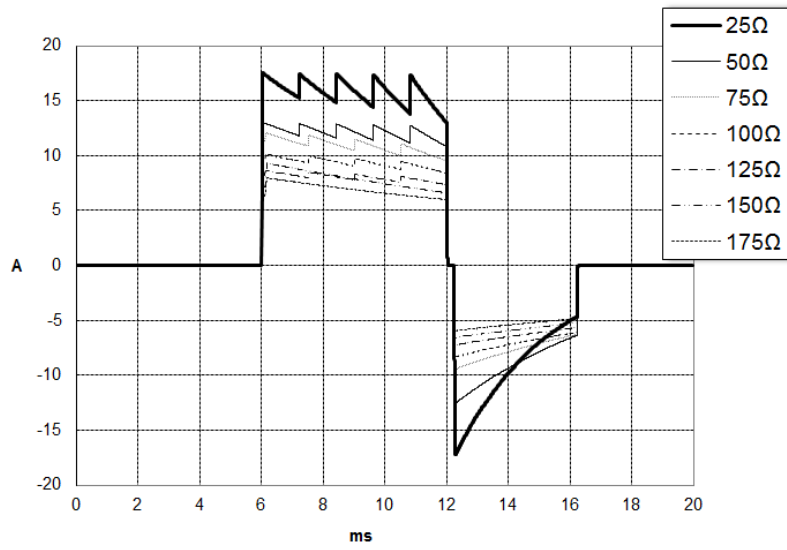
Figure 2. Rectilinear Biphasic Waveforms at 150 Joules



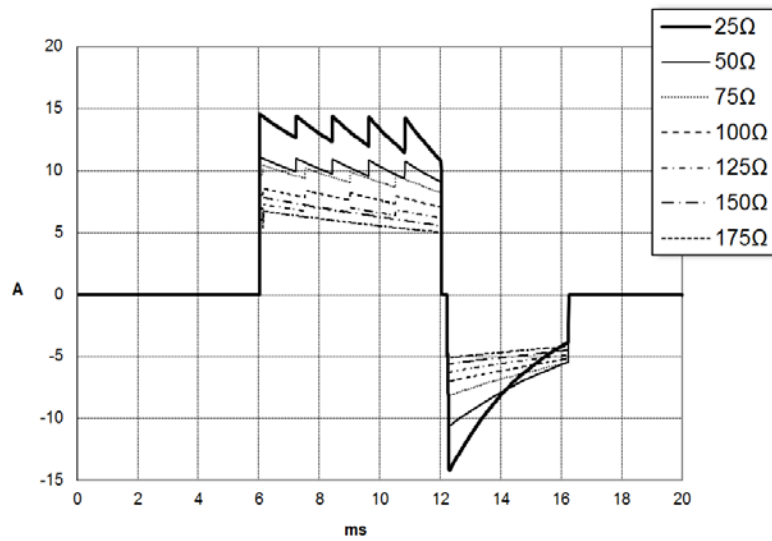
**Figure 3. Rectilinear Biphasic Waveforms at 120 Joules**



**Figure 4. Rectilinear Biphasic Waveforms at 85 Joules**



**Figure 5. Rectilinear Biphasic Waveforms at 70 Joules**



**Figure 6. Rectilinear Biphasic Waveforms at 50 Joules**

---

# Clinical Trial Results for the M Series Biphasic Waveform

The efficacy of the ZOLL Rectilinear Biphasic waveform has been clinically verified during a study of defibrillation of Ventricular Fibrillation (VF) and Ventricular Tachycardia (VT). A feasibility study was performed initially for defibrillation of VF/VT (n=20) on two separate groups of patients to ensure waveform safety and energy selection. Subsequently, a separate, multicenter, randomized clinical trial was performed to verify the waveform's efficacy. A description of this study is provided below. The study was performed using ZOLL defibrillation systems consisting of ZOLL defibrillators, the ZOLL Rectilinear Biphasic waveform, and ZOLL defibrillation pads.

## Randomized Multicenter Clinical Trial for Defibrillation of Ventricular Fibrillation (VF) and Ventricular Tachycardia (VT)

**Overview:** The defibrillation efficacy of the ZOLL Rectilinear Biphasic waveform was compared to a monophasic damped sine waveform in a prospective, randomized, multicenter study of patients undergoing ventricular defibrillation for VF/VT during electrophysiological studies, ICD implants, and test. A total of 194 patients were enrolled in the study. Ten patients who did not satisfy all protocol criteria were excluded from the analysis, leaving a study population of 184.

**Objectives:** The primary goal of this study was to compare the first shock efficacy of the 120 J Rectilinear Biphasic waveform with a 200 J monophasic waveform. The secondary goal was to compare all shock (three consecutive 120, 150, and 170 joules) efficacy of the Rectilinear Biphasic waveform with that of a monophasic waveform (three consecutive 200, 300, and 360 joules). A significance level of  $p=0.05$  or less was considered statistically significant using Fischer's Exact test. Also, differences between the two waveforms were considered statistically significant when the customary 95% or AHA-recommended 90%<sup>1</sup> confidence interval between the two waveforms was greater than 0%.

**Results:** The study population of 184 patients had a mean age of  $63 \pm 14$  years. Of these, 143 patients were male. 98 patients were in the biphasic group (ventricular fibrillation/flutter, n=80; ventricular tachycardia, n=18) and 86 patients were in the monophasic group (ventricular fibrillation/flutter, n=76; ventricular tachycardia, n=10). There were no adverse events or injuries related to the study.

---

1. Kerber RE, et al., "Automated External Defibrillators for Public Access Defibrillation: Recommendations for Specifying and Reporting Arrhythmia Analysis Algorithm Performance, Incorporating New Waveforms, and Enhancing Safety," *Circ J Am Heart Assoc.* 1997;95:1677-1682.

"... the task force suggests that to demonstrate superiority of an alternative waveform over standard waveforms, the upper boundary of the 90% confidence interval of the difference between standard and alternative waveforms must be <0% (ie, alternative is greater than standard)."

The first shock, first induction efficacy of biphasic shocks at 120 J was 99% versus 93% for monophasic shocks at 200 J ( $p=0.0517$ , 95% confidence interval of the difference of  $-2.7\%$  to  $16.5\%$  and 90% confidence interval of the difference of  $-1.01\%$  to  $15.3\%$ ).

	Monophasic	Biphasic
First shock efficacy	93%	99%
p-value	0.0517	
95% confidence interval	$-2.7\%$ to $16.5\%$	
90% confidence interval	$-1.01\%$ to $15.3\%$	

Successful defibrillation with Rectilinear Biphasic shocks was achieved with 58% less delivered current than with monophasic shocks ( $14\pm 1$  amperes versus  $33\pm 7$  amperes,  $p=0.0001$ ).

The difference in efficacy between the Rectilinear Biphasic and the monophasic shocks was greater in patients with high transthoracic impedance (greater than 90 ohms). The first shock, first induction efficacy of biphasic shocks was 100% versus 63% for monophasic shocks for patients with high impedance ( $p=0.02$ , 95% confidence interval of the difference of  $-0.0217\%$  to  $0.759\%$  and 90% confidence interval of the difference of  $0.037\%$  to  $0.706\%$ ).

	Monophasic	Biphasic
First shock efficacy (high impedance patients)	63%	100%
p-value	0.02	
95% confidence interval	$-0.0217\%$ to $0.759\%$	
90% confidence interval	$0.037\%$ to $0.706\%$	

A single patient required a second biphasic shock at 150 joules to achieve 100% efficacy versus six patients for whom monophasic shocks of up to 360 joules were required for 100% total defibrillation efficacy.

**Conclusion:** The data demonstrate the equivalent efficacy of low energy Rectilinear Biphasic shocks compared to standard high energy monophasic shocks for transthoracic defibrillation for all patients at the 95% confidence level. The data also demonstrate the superior efficacy of low energy Rectilinear Biphasic shocks compared to standard high energy monophasic shocks in patients with high transthoracic impedance at the 90% confidence level. There were no unsafe outcomes or adverse events due to the use of Rectilinear Biphasic waveform.

## Pre-Clinical Study

To support pediatric usage for the ZOLL Rectilinear Bi-Phasic Waveform, ZOLL submitted pre-clinical data to the FDA as part of a 510(k) submission for its AED Pro device (cleared by the FDA under K041892). The protocol for this pre-clinical study, along with a summary of the results, have been submitted to FDA under AED Pro PMA application (P160022). A summary of this study is presented below.

---

To demonstrate the safety and efficacy of our Rectilinear Bi-Phasic Waveform when used to treat pediatric VF patients, ZOLL conducted a study using a porcine model of pediatric patients less than 8 years of age. This study included 18 piglets in three (3) size groups (two (2) animals weighing 4 kg, eight (8) animals weighing 8 kg, and eight (8) animals weighing 16 kg) and compared the defibrillation dose/response curves observed using proposed biphasic waveform with those observed using a standard monophasic damped sine wave (DSW) defibrillator to treat short duration (~ 30 seconds) ventricular fibrillation. The study demonstrated that the biphasic waveform defibrillates pediatric pigs with equal efficacy but lower energy (on a Joules/kg basis) than traditional monophasic damped sine wave defibrillators. To confirm the safety of the proposed biphasic waveform in pediatric patients, we studied and compared measures of cardiac function before and after both DSW and Rectilinear Bi-Phasic Waveform defibrillation shocks over a range of relevant energies. The study demonstrated that the biphasic defibrillation produced equivalent or milder disturbances of cardiac function when compared to traditional DSW defibrillation at the same energies.

Another animal study compared the ZOLL rectilinear biphasic (RLB) waveform to a biphasic truncated exponential (BTE) waveform. The study, using an immature porcine model (n=21), was a prospective, randomized, controlled design to determine the dose response curves for the RLB and BTE defibrillation waveforms. A weight range from 4 to 24 Kg for an animal represented a pediatric patient. The weight ranging from 4 to 8 Kg represented a patient less than 1 year old (infant subgroup), and the weight range from 16 to 24 Kg represented a pediatric patient between the ages of 2 and 8 years (young children subgroup).

The ZOLL RLB waveform demonstrated a superior capability to defibrillate a porcine pediatric model with < 90% of the D50 energy required for a BTE waveform (D50 energy: RLB  $25.6 \pm 15.7$  J, BTE  $28.6 \pm 17.0$  J,  $P = 0.0232$ ; D90 energy: RLB  $32.6 \pm 19.1$  J, BTE  $37.8 \pm 23.2$  J,  $P = 0.0228$ ).

The ECG ST segment changes (mV) and LV pressure changes (dP/dt) following a defibrillation shock were compared between the RLB waveform to the BTE waveform. The RLB waveform had an average ST segment increase above baseline of  $0.138 \pm 0.136$  mV (N=401 shocks) compared to the BTE waveform's average increase of  $0.146 \pm 0.148$  mV (N=396 shocks). The RLB waveform had an average dP/dt at the 40 mmHg threshold (the point in time when an animal's blood pressure exceeded 40 mmHg spontaneously) of  $1987 \pm 411$  mmHg/s (N=496 shocks) compared to the BTE waveform's average dP/dt of  $2034 \pm 425$  mmHg/s (N=496 shocks).

## Published Clinical Data

Additional clinical data was included with PMA application P160022 to support out-of-hospital use of ZOLL's Rectilinear Bi-Phasic defibrillation waveform. The data reported by Hess et al in *Resuscitation* (82 (2011) 685–689) is considered sufficient to support ZOLL's defibrillation waveform in the out-of-hospital environment. The resulting clinical paper, "Performance of a rectilinear biphasic waveform in defibrillation of presenting and recurrent ventricular fibrillation: A prospective multicenter study," was included with PMA application P160015. A summary of the study is presented below:

---

**Objectives:** The study tested the hypothesis that shock success differs with initial and recurrent episodes of ventricular fibrillation (VF).

**Methods:** From September 2008 to March 2010 out-of-hospital cardiac arrest patients with VF as the initial rhythm at 9 study sites were defibrillated by paramedics using a rectilinear biphasic waveform. Shock success was defined as termination of VF within 5 s post-shock. The study used generalized estimating equation (GEE) analysis to assess the association between shock type (initial versus defibrillation) and shock success.

**Results:** Ninety-four patients presented in VF. Mean age was 65.4 years, 78.7% were male, and 80.9% were bystander-witnessed. VF recurred in 75 (79.8%). There were 338 shocks delivered for initial (n = 90) or recurrent (n = 248) VF available for analysis. Initial shocks terminated VF in 79/90 (87.8%) and subsequent shocks in 209/248 (84.3%). GEE odds ratio (OR) for shock type was 1.37 (95% CI 0.68–2.74). After adjusting for potential confounders, the OR for shock type remained insignificant (1.33, 95% CI 0.60–2.53). The study observed no significant difference in ROSC (54.7% versus 52.6%, absolute difference 2.1%, p = 0.87) or neurologically intact survival to hospital discharge (21.9% versus 33.3%, absolute difference 11.4%, p = 0.31) between those with and without VF recurrence.

**Conclusions:** Presenting VF was terminated with one shock in 87.8% of cases. The study observed no significant difference in the frequency of shock success between initial versus recurrent VF. VF recurred in the majority of patients and did not adversely affect shock success, ROSC, or survival.



---

## ECG Analysis Algorithm Accuracy

Sensitivity and specificity are expressions of ECG analysis algorithm performance when compared to ECG interpretation by a clinician or expert. Sensitivity refers to the algorithm's ability to correctly identify shockable rhythms (as a percentage of the total number of shockable rhythms). Specificity refers to the algorithm's ability to correctly identify non-shockable rhythms (as a percentage of the total number of non-shockable rhythms). The data in the following tables summarizes the accuracy of the ECG analysis algorithm as tested against ZOLL's ECG Rhythm Database.

The algorithm sequence takes approximately six to nine seconds and proceeds as follows:

- Divides the ECG rhythm into three-second segments.
- Filters and measures noise and artifact.
- Measures baseline content ('waviness' at the correct frequencies) of the signal.
- Measures QRS rate, width, and variability.
- Measures amplitude and temporal regularity ('auto-correlation') of peaks and troughs.
- Determines if two out of three segments are shockable then prompts the user to treat the patient.
- Stops analyzing the ECG after detecting a shockable rhythm and alerts the user that the device is ready to deliver a shock.
- Prompts the user to return to CPR if the ECG rhythm is determined to be non-shockable.

## Clinical Performance Results

The following two tables represent clinical performance results of adult and pediatric patients.

**Table 9. Clinical Performance Results (Adult Patients)**

Rhythms	Sample Size	Performance Goals	Observed Performance	90% One-sided Lower Confidence Limit
<b>Shockable</b>				
		<b>Sensitivity</b>		
Coarse VF	536	>90%	>99%	>99%
Rapid VT	80	>75%	>98%	>94%
<b>Non-shockable</b>				
		<b>Specificity</b>		
NSR	2210	>99%	>99%	>99%
AF, SB, SVT, Heart block, idioventricular, PVCs	819	>95%	>99%	>99%
Asystole	115	>95%	>99%	>97%
<b>Intermediate</b>				
Fine VF	69	Report only	Sensitivity >94%	>87%
Other VT	28	Report only	>99%	>89%

**Table 10. Clinical Performance Results (Pediatric Patients)**

Rhythms	Sample Size	Performance Goals	Observed Performance	90% One-sided Lower Confidence Limit
<b>Shockable</b>				
		<b>Sensitivity</b>		
Coarse VF	42	>90%	>99%	>93%
Rapid VT	79	>75%	>99%	>96%
<b>Non-shockable</b>				
		<b>Specificity</b>		
NSR	208	>99%	>99%	>98%
AF, SB, SVT, Heart block, idioventricular, PVCs	348	>95%	>99%	>97%
Asystole	29	>95%	>99%	>90%
<b>Intermediate</b>				
Fine VF	0	Report only	>NA	>NA
Other VT	44	Report only	>81%	>69%

---

**Table 11. Rhythm Recognition Detector Categories (Adult Patients)**

	<b>VF and VT</b>	<b>All Other ECG Rhythms</b>
<b>Shock</b>	680	1
<b>Non-shockable</b>	5	3171

A true positive (680) is a correct classification of a shockable rhythm. A true negative (3171) is a correct classification of all rhythms for which a shock is not indicated. A false positive (1) is an organized or perfusing rhythm or asystole that has been incorrectly classified as a shockable rhythm. A false negative (5) is a VF or VT associated with cardiac arrest that has been incorrectly classified as non-shockable.

**Table 12. Rhythm Recognition Detector Categories (Pediatric Patients)**

	<b>VF and VT</b>	<b>All Other ECG Rhythms</b>
<b>Shock</b>	121	10
<b>Non-shockable</b>	0	619

A true positive (121) is a correct classification of a shockable rhythm. A true negative (619) is a correct classification of all rhythms for which a shock is not indicated. A false positive (10) is an organized or perfusing rhythm or asystole that has been incorrectly classified as a shockable rhythm. A false negative (0) is a VF or VT associated with cardiac arrest that has been incorrectly classified as non-shockable.

---

# Wireless Output Guidance and Manufacturer's Declaration

## RF Transmission Emitted (IEC 60601-1-2)

The ZOLL AED 3 unit complies with IEC 60601-1-2 for medical electrical equipment and medical electrical systems that include RF transmitters as specified below.

Standard	Frequency Range	Effective Radiated Power	Modulation Type	Data Rates
802.11b	2412-2472 MHz	100 mW	DSSS	1, 2, 5.5, 11 Mbps
802.11g	2412-2472 MHz	32 mW	OFDM	6, 9, 12, 24, 36, 48, 54 Mbps
802.11n	2412-2472 MHz	32 mW	OFDM	6.5, 13, 19.5, 26, 39, 52, 58.5, 65 Mbps
802.11a	5180-5320 MHz 5500-5700 MHz 5745-5825 MHz	32 mW	OFDM	6, 9, 12, 24, 36, 48, 54 Mbps
802.11n	5180-5320 MHz 5500-5700 MHz 5745-5825 MHz	32 mW	OFDM	6.5, 13, 19.5, 26, 39, 52, 58.5, 65 Mbps

## FCC Notice

Contains FCC ID: MCQ-CCi.MX28

ZOLL Medical Corporation has not approved any changes or modifications to this device by the user. Any changes or modifications could void the user's authority to operate the equipment. See 47 CFR Section 15.21.

This device complies with part 15 of the FCC Rules. Operation is subject to the following two conditions: (1) This device may not cause harmful interference, and (2) this device must accept any interference received, including interference that may cause undesired operation.

**NOTE** "Harmful interference" is defined by the FCC as follows:

Any emission, radiation, or induction that endangers the functioning of a radio navigation service or other safety services or seriously degrades, obstructs, or repeatedly interrupts a radio communication service operating in accordance with FCC rules.

The user is cautioned to maintain 20 cm (8 inches) of space from the product to ensure compliance with FCC requirements.

## Canada, Industry Canada (IC) Notices

Contains Model ConnectCard™ for i.MX28 Radio, IC: 1846A-CCi.MX28

This device complies with Industry Canada license-exempt RSS standard(s). Operation is subject to the following two conditions: (1) this device may not cause interference, and (2) this device must accept any interference, including interference that may cause undesired operation of the device.

**FCC/IC/EU:** This device is limited to indoor use in the 5150 MHz to 5250 MHz band.

# Appendix C

## Accessories

### Accessories

The following accessories are compatible for use with the ZOLL AED 3 defibrillator. To order any of these items, contact your local ZOLL representative.

**NOTE** The use of accessories other than those specified in this appendix may result in increased emissions or decreased immunity of the ZOLL AED 3 defibrillator.

Accessory	REF
<i>Defibrillation Pads</i>	
• CPR-D padz	8900-0800-01
• CPR Stat-padz	8900-0402
• Stat-padz II	8900-0801-01
• Pedi-padz II	8900-0810-01
<i>Battery</i>	
• AED 3 Battery Pack	8000-000696
<i>Carry Cases</i>	
• Battery Case	8000-001251
• Replacement Shoulder Strap	8000-001252
• AED 3 Carry Case	8000-001250
• Small Rigid Plastic Case	8000-001253
• Large Rigid Plastic Case	8000-001254

<b>Accessory</b>	<b>REF</b>
<i>Wall Mounts/Cabinets</i>	
• Standard Surface Wall Cabinet	8000-001256
• Semi-recessed Wall Cabinet	8000-001257
• Fully-recessed Wall Cabinet	8000-001258
• Device Wall Mount Bracket	8000-001255
• Case Wall Mount Bracket	8000-001266
• Strobe for Standard Surface Wall Cabinet	8000-001259
• Strobe for Semi/Fully-recessed Wall Cabinet	8000-001267
<i>Wall Signs</i>	
• ILCOR Flush Wall Sign (AED)	8000-001260
• ILCOR 3D Wall Sign (AED)	8000-001261
• ILCOR Flush Wall Sign (DAE)	8000-001262
• ILCOR 3D Wall Sign (DAE)	8000-001263
• ILCOR Flush Wall Sign (DEA)	8000-001264
• ILCOR 3D Wall Sign (DEA)	8000-001265
<i>Simulation/Training</i>	
• ZOLL AED Simulator	8000-000925
• Training CPR Uni-padz	8900-000264
<i>Documentation</i>	
• ZOLL AED 3 Operator's Manual	9650-000750-01

# Appendix D

## Configuration Settings

### Overview

This section describes the configurable settings for the ZOLL AED 3 defibrillator. The configuration settings can be manually selected through the use of the LCD touch screen, or automatically configured by reading a configuration file directly from a USB flash drive.




Device Configuration icon






Press the Device Configuration icon to access the configuration window. To import a configuration file from a USB flash drive, see “Importing Files from a USB Flash Drive” on page 16.



Supervisor Access icon







There are two levels of configuration settings: user and supervisor. The supervisor settings are indicated by the Supervisor Access icon. You need a pass code to access these advanced settings (the default passcode is listed under “Set Supervisor Passcode” on page 62). Press the icons on the screen to access the configuration settings below. Once you set up your AED to put it into service, ZOLL recommends that you create a new supervisor passcode.







User/Supervisor Setting	Description	Values
<p><i>Language</i></p>  <p><b>Note:</b> This setting is also available to the Supervisor user.</p>	User configurable for one language (up to three possible languages depending on the ordered device configuration).	<ul style="list-style-type: none"><li>• Language 1 (default)</li><li>• Language 2</li><li>• Language 3</li></ul>







User/Supervisor Setting	Description	Values
<p><i>Lay Rescuer Prompts</i></p>  <p><b>Note:</b> This setting is also available to the Supervisor user.</p>	<p>When enabled (<b>ON</b>), the AED issues the following audio and text prompts after completion of the power-on self-test and entry into clinical mode:</p> <p><i>STAY CALM</i>  <i>CHECK RESPONSIVENESS</i>  <i>CALL FOR HELP</i></p> <p><b>Note:</b> If defibrillation pads are pre-attached to the patient, these prompts are not issued.</p>	<ul style="list-style-type: none"> <li>• ON (default)</li> <li>• OFF</li> </ul>
<p><i>Check Breathing Prompts</i></p>  <p><b>Note:</b> This setting is also available to the Supervisor user.</p>	<p>Allows you to enable the check breathing prompts, “Open Airway and Check Breathing”, based on the guidelines you want to follow.</p> <p>When disabled (<b>OFF</b>), these prompts are not issued.</p> <p><b>Note:</b> If defibrillation pads are pre-attached to the patient, these prompts are not issued.</p>	<ul style="list-style-type: none"> <li>• ON</li> <li>• OFF (default)</li> </ul>
<p><i>CPR Depth Measure Units</i></p>  <p><b>Note:</b> This setting is also available to the Supervisor user.</p>	<p>Allows you to set the CPR depth measurement units to inches or centimeters.</p>	<ul style="list-style-type: none"> <li>• Inches--in</li> <li>• Centimeters--cm</li> </ul> <p><b>Note:</b> The default value depends on the AED’s primary language.</p>
<p><i>Date</i></p>  <p><b>Note:</b> This setting is also available to the Supervisor user.</p>	<p>Allows you to manually set the date on the AED.</p>	<p>Month/Day/Year</p>
<p><i>Time</i></p>  <p><b>Note:</b> This setting is also available to the Supervisor user.</p>	<p>Allows you to manually set the time and to specify the time zone.</p> <p>When <i>Auto Adjust for Daylight Savings</i> is enabled (<b>ON</b>), the AED’s 24-hour clock automatically adjusts for Daylight Savings Time.</p> <p><b>Note:</b> You must select a time zone for this setting to work.</p>	<ul style="list-style-type: none"> <li>• 00:00:00</li> <li>• Dateline</li> <li>• American Samoa</li> <li>• Hawaii</li> <li>• Alaska</li> <li>• N. A. Pacific</li> <li>• N. A. Mountain</li> <li>• N. A. Central</li> <li>• N. A. Eastern (default)</li> <li>• Cuba</li> <li>• Columbia</li> <li>• Venezuela</li> <li>• Atlantic (includes Puerto Rico and Virgin Islands)</li> <li>• Paraguay</li> <li>• Newfoundland</li> </ul>



User/Supervisor Setting	Description	Values
<p><i>Time (cont'd)</i></p>  <p><b>Note:</b> This setting is also available to the Supervisor user.</p>		<ul style="list-style-type: none"> <li>• Chile</li> <li>• Falkland Islands</li> <li>• Greenland</li> <li>• Brazil (São Paulo)</li> <li>• Mid Atlantic (including the east coast of Brazil)</li> <li>• Azores</li> <li>• UTC</li> <li>• Western Europe</li> <li>• Central Europe</li> <li>• Namibia</li> <li>• Algeria</li> <li>• Eastern Europe</li> <li>• Egypt</li> <li>• Lebanon</li> <li>• Syria</li> <li>• Kaliningrad</li> <li>• Iraq</li> <li>• Moscow</li> <li>• Arabia</li> <li>• Iran</li> <li>• Samara</li> <li>• Afghanistan</li> <li>• Western Asia</li> <li>• Yekaterinburg</li> <li>• India</li> <li>• Central Asia</li> <li>• Omsk</li> <li>• Southeast Asia</li> <li>• Krasnoyarsk</li> <li>• Irkutsk</li> <li>• China</li> <li>• W. Australia</li> <li>• Japan (includes Korea)</li> <li>• Yakutsk</li> <li>• Central Australia</li> <li>• E. Australia</li> <li>• Vladivostok</li> <li>• Central Pacific (includes Guam)</li> <li>• Srednekolymysk</li> <li>• New Zealand</li> <li>• Kamchatka</li> </ul>

Supervisor Setting (Advanced)	Description	Values
<p><i>Number of Clinical Cases</i></p> 	<p>Sets the number of patient cases that are stored in nonvolatile memory.</p>	<ul style="list-style-type: none"> <li>• 1</li> <li>• 2 (default)</li> </ul>
<p><i>Self-Test Interval (Days)</i></p> 	<p>Sets the period of time between automated self-tests in standby state.</p>	<ul style="list-style-type: none"> <li>• 1 day</li> <li>• 7 days (default)</li> </ul>
<p><i>Auto Self-Test Report</i></p> 	<p>When enabled (<b>ON</b>) and following the completion of a periodic self test, the ZOLL AED 3 will attempt to link to ZOLL PlusTrac via an active Wi-Fi connection.</p> <p><b>Note:</b> The device history Wi-Fi configuration setup must be completed for this to function (see “Setting Up Device History Wi-Fi Configuration” on page 69).</p>	<ul style="list-style-type: none"> <li>• ON</li> <li>• OFF (default)</li> </ul>
<p><i>Audio Recording (ZOLL AED 3 BLS model only)</i></p> 	<p>Enables audio recording during Rescue Mode.</p>	<ul style="list-style-type: none"> <li>• ON</li> <li>• OFF (default)</li> </ul>
<p><i>Device Display (ZOLL AED 3 BLS model only)</i></p> 	<p>Allows you to select information displayed on the LCD screen during clinical use.</p> <p><b>Lay User</b> -- Displays text prompts and graphics.</p> <p><b>CPR Only</b> - Displays text prompts and the CPR Dashboard during the CPR cycle.</p> <p><b>CPR and ECG</b> - Displays text prompts, the patient’s ECG rhythm, and the CPR Dashboard during the CPR cycle.</p>	<ul style="list-style-type: none"> <li>• Lay User</li> <li>• CPR Only</li> <li>• CPR and ECG (default)</li> </ul>
<p><i>Set Supervisor Passcode</i></p> 	<p>Allows you to change the passcode used to enter Supervisor mode.</p> <p><b>Note:</b> The AED ships with a default Supervisor passcode of 123456. ZOLL recommends that you change the default passcode as soon as the new device setup is complete.</p> <p>Write the new passcode on the line below and put this document in a secure location for future reference.</p> <p>_____</p>	<ul style="list-style-type: none"> <li>• Six numeric digits</li> </ul>

Supervisor Setting (Advanced)	Description	Values
<p><i>Device ID</i></p> 	<p>Allows you to input an alpha-numeric device identifier for RescueNet Code Review.</p>	<ul style="list-style-type: none"> <li>• Eleven alpha-numeric digits</li> </ul>
User/Supervisor Setting	Description	Values
<p><i>Export Files</i></p>  <p><b>Note:</b> This setting is also available to the general user.</p>	<p>You can upload files from the AED to a USB flash drive or through a wireless connection.</p> <p><b>Note:</b> You can only upload configuration files to a USB flash drive, not through Wi-Fi.</p>	<ul style="list-style-type: none"> <li>• Clinical Archives (all)</li> <li>• Clinical Archives (new)</li> <li>• Device History</li> <li>• Configuration</li> </ul>
<p><i>Import Files</i></p> 	<p>You can download files from a USB flash drive to the AED.</p>	<ul style="list-style-type: none"> <li>• Configuration</li> <li>• System Software</li> <li>• Root Certificates</li> </ul>
Supervisor Setting	Description	Values
<p><i>Adult Energy Settings</i></p> 	<p>Sets the energy level in joules for an adult patient for the first, second, and third shocks.</p>	<p>Shock 1</p> <ul style="list-style-type: none"> <li>• 120 J (default)</li> <li>• 150 J</li> <li>• 200 J</li> </ul> <p>Shock 2</p> <ul style="list-style-type: none"> <li>• 120 J</li> <li>• 150 J (default)</li> <li>• 200 J</li> </ul> <p>Shock 3</p> <ul style="list-style-type: none"> <li>• 120 J</li> <li>• 150 J</li> <li>• 200 J (default)</li> </ul>
<p><i>Child Energy Settings</i></p> 	<p>Sets the energy level in joules for a child patient for the first, second, and third shocks.</p>	<p>Shock 1</p> <ul style="list-style-type: none"> <li>• 50 J (default)</li> <li>• 70 J</li> <li>• 85 J</li> </ul> <p>Shock 2</p> <ul style="list-style-type: none"> <li>• 50 J</li> <li>• 70 J (default)</li> <li>• 85 J</li> </ul> <p>Shock 3</p> <ul style="list-style-type: none"> <li>• 50 J</li> <li>• 70 J</li> <li>• 85 J (default)</li> </ul>
<p><i>Breathe During CPR Prompt</i></p> 	<p>When this option is enabled (<b>ON</b>), the AED prompts <i>Give Two Breaths</i> every 30 recognized compressions.</p>	<ul style="list-style-type: none"> <li>• ON</li> <li>• OFF (default)</li> </ul>

Supervisor Setting	Description	Values
<p><i>Continue CPR Prompt</i></p> 	<p>"Continue CPR" prompt will be repeated every "N" seconds (based on the <i>CPR Prompt Interval</i>) if CPR compressions stop during the CPR interval.</p> <p>When this option is disabled (<b>OFF</b>), the "Continue CPR" prompt is not issued during the CPR period.</p>	<ul style="list-style-type: none"> <li>• ON (default)</li> <li>• OFF</li> </ul>
<p><i>CPR Prompt Interval</i></p> 	<p>This option determines the interval for the following prompts:</p> <ul style="list-style-type: none"> <li>• <i>START CPR</i></li> <li>• <i>CONTINUE CPR</i></li> </ul>	<ul style="list-style-type: none"> <li>• 10 seconds (default)</li> <li>• 15 seconds</li> </ul>
<p><i>Start with CPR Period</i></p> 	<p>Sets the duration of the "Start with CPR" period once defibrillation pads are attached to the patient.</p>	<ul style="list-style-type: none"> <li>• Off</li> <li>• 30 seconds</li> <li>• 60 seconds (default)</li> <li>• 90 seconds</li> <li>• 120 seconds</li> <li>• 150 seconds</li> <li>• 180 seconds</li> </ul>
<p><i>No Shock CPR Period</i></p> 	<p>Sets the duration of the CPR period following a No Shock Advised result from the analysis.</p>	<ul style="list-style-type: none"> <li>• 60 seconds</li> <li>• 90 seconds</li> <li>• 120 seconds (default)</li> <li>• 150 seconds</li> <li>• 180 seconds</li> </ul>
<p><i>Post Shock CPR Period</i></p> 	<p>Sets the duration of the CPR period following the delivery of a shock.</p>	<ul style="list-style-type: none"> <li>• 60 seconds</li> <li>• 90 seconds</li> <li>• 120 seconds (default)</li> <li>• 150 seconds</li> <li>• 180 seconds</li> </ul>
<p><i>Wi-Fi Settings</i></p> 	<p>These icons contain the settings to set up your wireless connection. See "<i>Setting Up Your Wireless Configuration</i>" on page 65, for more information.</p>	

---

## Setting Up Your Wireless Configuration

This section describes how to set up a wireless connection for your AED for uploading both clinical archives and the device history. The wireless settings are accessible when the ZOLL AED 3 defibrillator is in AED Management Mode. The Wi-Fi settings are located in the Supervisor menu for advanced users. You need a six-digit pass code to enter the Supervisor menu (see “Set Supervisor Passcode” on page 62 for more information). The configuration setup has two options for both clinical archives and device history:

- **Quick Setup** - For users with a simple configuration using the default settings.
- **IT Setup** - For users with a more complex configuration using specific wireless settings.

**NOTE** Prior to setting up your clinical archive configuration, visit [zollonline.com](http://zollonline.com) to create a ZOLL Case Review account.

**NOTE** Prior to setting up your device history configuration, refer to the PlusTrac Activation Certificate (in your documentation folder) for instructions on how to register for AED Program Management.

You can also automatically configure the Wi-Fi settings for the AED by downloading a configuration file directly from a USB flash drive. For detailed information on how to do this, see “Importing Files from a USB Flash Drive” on page 16.

### For IT Setup Only

Client certificates are needed for the Wi-Fi configuration setup only if you are using the TLS method of Wi-Fi authentication. When you select TLS during the Wi-Fi setup, you will need to select a client certificate as part of the setup process.

Additional root certificates are only needed if you are not using the ZOLL standard Self-Signed (SSL) Certificate. If you are not using an SSL Certificate, you need to import the root SSL certificate to use either before you start the Wi-Fi configuration, or during the process of setting up the configuration. For detailed information on how to import a root certificate, see “Importing Files from a USB Flash Drive” on page 16.

ZOLL supports the following root and client certificates:

Root Certificates	Client Certificates
.pem (b64 encoded)	.pfx (binary)
.der (binary)	
.p7b (Microsoft Chained Certificate)	



Device Configuration icon

## Entering Supervisor Configuration Mode

To enter configuration mode, follow the steps below:

1. Press and hold down the On/Off button for more than 5 seconds. Then press the Device Configuration icon to access the configuration window.



Supervisor Access icon

2. Press the Supervisor icon, and enter your six-digit passcode. You will need to set up the configuration settings for both the clinical archives as well as the device history. See the following sections for step-by-step instructions on both of these configuration setups.

## Setting Up Clinical Archive Wi-Fi Configuration



Clinical Archive Wi-Fi icon

Press the Clinical Archive Wi-Fi icon to access the Select Wi-Fi Setup Level window and make one of the following selections:

- **Quick Setup** - for a simple configuration using the default settings (go to "Quick Setup for Clinical Archives" below).
- **IT Setup** - for a more complex configuration using non-standard wireless setup settings (go to "IT Setup for Clinical Archives" on page 67).

## Quick Setup for Clinical Archives

1. Press the Quick Setup button to access the Clinical Archive Quick Settings window and enter the applicable information in the following fields:



Wireless button

- **Network (SSID)**--Press the wireless button to the right of this field to search for available wireless networks. Select a network from the list and press **OK**. Alternately, you can use the alpha-numeric keypad to enter the SSID (Service Set Identifier) name that identifies your wireless network access point. Press **OK**.
- **Password (Pre-Shared Key)** - Use the alpha-numeric keypad to enter the pre-shared key (password) to the wireless access point. Press **OK**.
- **Server Settings** - Press the Server Settings field to display the Server Settings window. Use the alpha-numeric keypad to enter the following server information.

<i>Address</i>	The default is dxsvc.zollonline.com. If you are using the default server, keep this entry the same. Otherwise, enter the URL address of the host server. Press <b>OK</b> .
----------------	--

<i>User ID</i>	Use the alpha-numeric keypad to enter the user-name of the host server. Press <b>OK</b> . <b>Note:</b> If you have set up a ZOLL Case Review account on zollonline.com, use the ID you specified for that account.
----------------	---

<i>Passcode</i>	Use the alpha-numeric keypad to enter your password of the host server. Press <b>OK</b> . <b>Note:</b> If you have set up a ZOLL Case Review account on zollonline.com, use the passcode you specified for that account.
-----------------	---

- 
2. Press the **Test Wi-Fi** button in the Clinical Archive Quick Settings window to test the server connectivity.

**NOTE** If connectivity is not successful, check your wireless configuration settings.

3. Press **Save** at the bottom right of the screen to save the changes. The AED displays the message *SAVING CONFIGURATION, PLEASE WAIT*. When the AED has saved the configuration, it displays the Advanced Configuration window.

## IT Setup for Clinical Archives



Clinical Archive  
Wi-Fi icon

1. Press the Clinical Archive Wi-Fi icon.
2. Press the IT Setup button to access the Clinical Archive Wi-Fi Settings window.



Network  
Settings icon

3. Press the Network Settings icon. The Network Settings window displays.
4. In the DHCP (Dynamic Host Configuration Protocol) field, select ON or OFF:
  - If you select ON, all necessary information is obtained from the network. Press **OK** and go to step 6.
  - If you select OFF, all of the network setup fields display in the Network Settings window. Go to step 5 to enter the static information.
5. You can either keep all of the displayed default settings and press **OK**, or you can enter information in the following fields:

- *Local IP Address* - Use the numeric keypad to enter your Local IP address (format is xxx.xxx.xxx.xxx where xxx = 000-255). Press **OK**.
- *Gateway IP Address* - Use the numeric keypad to enter your Gateway IP address (format is xxx.xxx.xxx.xxx where xxx = 000-255). Press **OK**.
- *Subnet Mask* - Use the numeric keypad to enter your Subnet Mask (format is xxx.xxx.xxx.xxx where xxx = 000-255). Press **OK**.
- *Primary DNS (Domain Name Server) IP Address* - Use the numeric keypad to enter your Primary DNS IP address (format is xxx.xxx.xxx.xxx where xxx = 000-255). Press **OK**.
- *Secondary DNS IP Address* - Use the numeric keypad to enter your Secondary DNS IP Address (format is xxx.xxx.xxx.xxx where xxx = 000-255). Press **OK**.

6. Press **OK** to save the Network settings.



Server  
Settings  
icon

7. Press the Server Settings icon to access the Server Settings window and enter information in the following fields:
  - *Mode*: Select URL or IP.

- *Address* - The default is dxsvc.zollonline.com. Use the alpha-numeric keypad to change this default only if your URL/IP is different than the default.

**NOTE** If you are not using the default value, you need to make an entry in the DNS table for the default value, and you will have to import a new SSL root certificate. For detailed information on how to import a root certificate, see “Importing Files from a USB Flash Drive” on page 16.

- *Port* - The default is 443. Change this default only if your port is different than the default.
- *User ID* - Use the alpha-numeric keypad to enter the User ID. Press **OK**.

**NOTE** If you have set up a ZOLL Case Review account on zollonline.com, use the ID you specified for that account.

- *Passcode* - Use the alpha-numeric keypad to enter the Passcode. Press **OK**.

**NOTE** If you have set up a ZOLL Case Review account on zollonline.com, use the Passcode you specified for that account.

8. Press **OK** to save the Server settings.



Profile Settings icon

9. Press the Profile Settings icon and enter information in the following fields in the Profile Settings window:

- *Network (SSID)* - Use the alpha-numeric keypad to enter the SSID (Service Set Identifier) name that identifies your wireless access point.
- *Hidden SSID* - Select ON or OFF.
- *Authentication* - Select the method of Wi-Fi Authentication: PSK (Pre-shared Key), PEAP (Protected Extensible Authentication Protocol), or TLS (Transport Layer Security). See the table below for the next step based on the method you selected.

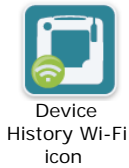
Wi-Fi Method	Field(s) to Complete
PSK	<i>Password (Pre-Shared Key)</i> - Use the alpha-numeric keypad to enter the password to the wireless access point. Press <b>OK</b> .
PEAP	<i>Username</i> - Use the alpha-numeric keypad to enter the username. Press <b>OK</b> .  <i>Password</i> - Use the alpha-numeric keypad to enter the password to the wireless access point. Press <b>OK</b> .
TLS	<i>User Identity</i> - Use the alpha-numeric keypad to enter the user identity. Press <b>OK</b> .  <i>Private Key Password</i> - Use the alpha-numeric keypad to enter the password. Press <b>OK</b> .  <i>Client Certificate</i> - Choose a client certificate from the list and press <b>OK</b> .



10. Press **OK** to save the Profile settings.
11. Press the **Test Wi-Fi** button in the Clinical Archive Wi-Fi Settings window to test the server connectivity.
 

**NOTE** If connectivity is not successful, check your wireless configuration settings.
12. Press **Save** to save the Wi-Fi settings. The AED displays the message *SAVING CONFIGURATION, PLEASE WAIT*. When the AED has saved the configuration, it displays the Advanced Configuration window.

## Setting Up Device History Wi-Fi Configuration



Press the Device History Wi-Fi icon to access the Select Wi-Fi Setup Level window and make one of the following selections:

- **Quick Setup** - for a simple configuration using the default settings (go to "Quick Setup for Device History" below).
- **IT Setup** - for a more complex configuration using non-standard wireless setup settings (go to "IT Setup for Device History" on page 70)

### Quick Setup for Device History

1. Press the Device History Wi-Fi icon to access the Device History Quick Settings window and enter the applicable information in the following fields:



- **Network (SSID)**--Press the wireless button to the right of this field to search for available wireless networks. Select a network from the list and press **OK**.  
Alternately, you can use the alpha-numeric keypad to enter the SSID (Service Set Identifier) name that identifies your wireless network access point. Press **OK**.
- **Password (Pre-Shared Key)** - Use the alpha-numeric keypad to enter the pre-shared key (password) to the wireless access point. Press **OK**.
- **Server Settings** - Press the Server Settings field to display the Server Settings window. Use the alpha-numeric keypad to enter the following server information.

<i>Address</i>	The default is dxsvc.zollonline.com. If you are using the default server, keep this entry the same. Otherwise, enter the URL address of the host server. Press <b>OK</b> .
<i>User ID</i>	Use the alpha-numeric keypad to enter the user-name of the host server. Press <b>OK</b> .
<i>Passcode</i>	Use the alpha-numeric keypad to enter your password of the host server. Press <b>OK</b> .

2. Press the **Test Wi-Fi** button in the Device History Quick Settings window to test the server connectivity.

**NOTE** If connectivity is not successful, check your wireless configuration settings.

- 
3. Press **Save** at the bottom right of the screen to save the changes. The AED displays the message *SAVING CONFIGURATION, PLEASE WAIT*. When the AED has saved the configuration, it displays the Advanced Configuration window.

## IT Setup for Device History



Device History  
Wi-Fi icon

1. Press the Device History Wi-Fi icon.
2. Press the IT Setup button to access the Device History Wi-Fi Settings window.



Network  
Settings icon

3. Press the Network Settings icon. The Network Settings window displays.
4. In the DHCP (Dynamic Host Configuration Protocol) field, select ON or OFF:
  - If you select ON, all necessary information is obtained from the network. Press **OK** and go to step 6.
  - If you select OFF, all of the network setup fields display in the Network Settings window. Go to step 5 to enter the static information.
5. You can either keep all of the displayed default settings and press **OK**, or you can enter information in the following fields:

- *Local IP Address* - Use the numeric keypad to enter your Local IP address (format is xxx.xxx.xxx.xxx where xxx = 000-255). Press **OK**.
- *Gateway IP Address* - Use the numeric keypad to enter your Gateway IP address (format is xxx.xxx.xxx.xxx where xxx = 000-255). Press **OK**.
- *Subnet Mask* - Use the numeric keypad to enter your Subnet Mask (format is xxx.xxx.xxx.xxx where xxx = 000-255). Press **OK**.
- *Primary DNS (Domain Name Server) IP Address* - Use the numeric keypad to enter your Primary DNS IP address (format is xxx.xxx.xxx.xxx where xxx = 000-255). Press **OK**.
- *Secondary DNS IP Address* - Use the numeric keypad to enter your Secondary DNS IP Address (format is xxx.xxx.xxx.xxx where xxx = 000-255). Press **OK**.

6. Press **OK** to save the Network settings.



Server  
Settings  
icon

7. Press the Server Settings icon and enter information in the following fields:
  - *Mode*: Select URL or IP.
  - *Address* - The default is dxsvc.zollonline.com. Use the alpha-numeric keypad to change this default only if your URL/IP is different than the default.

**NOTE** If you are not using the default value, you need to make an entry in the DNS table for the default value, and you will have to import a new SSL root certificate. For detailed information on how to import a root certificate, see "Importing Files from a USB Flash Drive" on page 16.

- *Port* - The default is 443. Change this default only if your port is different than the default.
- *User ID* - Use the alpha-numeric keypad to enter the User ID. Press **OK**.

**NOTE** If you are using the default server, this field automatically populates.

- *Passcode* - Use the alpha-numeric keypad to enter the Passcode. Press **OK**.

**NOTE** If you are using the default server, this field automatically populates.

8. Press **OK** to save the Server settings.



Profile Settings icon

9. Press the Profile Settings icon and enter information in the following fields:

- *Network SSID* - Use the alpha-numeric keypad to enter the SSID (Service Set Identifier) name that identifies your wireless access point.
- *Hidden SSID* - Select ON or OFF.
- *Authentication* - Select the method of Wi-Fi Authentication: PSK (Pre-shared Key), PEAP (Protected Extensible Authentication Protocol), or TLS (Transport Layer Security). See the table below for the next step based on the method you selected.

Wi-Fi Method	Field(s) to Complete
PSK	<i>Password (Pre-Shared Key)</i> - Use the alpha-numeric keypad to enter the password to the wireless access point. Press <b>OK</b> .
PEAP	<i>Username</i> - Use the alpha-numeric keypad to enter the username. Press <b>OK</b> .  <i>Password</i> - Use the alpha-numeric keypad to enter the password to the wireless access point. Press <b>OK</b> .
TLS	<i>User Identity</i> - Use the alpha-numeric keypad to enter the user identity. Press <b>OK</b> .  <i>Private Key Password</i> - Use the alpha-numeric keypad to enter the password. Press <b>OK</b> .  <i>Client Certificate</i> - Choose a client certificate from the list and press <b>OK</b> .

10. Press **OK** to save the Profile settings.

11. Press the **Test Wi-Fi** button in the Device History Wi-Fi window to test the server connectivity.

**NOTE** If connectivity is not successful, check your wireless configuration settings.

12. Press **Save** to save the Wi-Fi settings. The AED displays the message *SAVING CONFIGURATION, PLEASE WAIT*. When the AED has saved the configuration, it displays the Advanced Configuration window.



**ZOLL AED 3™**

Operator's Manual



**ZOLL®**

## **Indications for Use**

The ZOLL AED 3 system is indicated for use when a suspected cardiac arrest victim has an apparent lack of circulation as indicated by:

- Unconsciousness
- Absence of breathing, and
- Absence of pulse and other signs of circulation.

The AED 3 system is indicated for adult and pediatric patients.

## **Contraindications for Use**

Never use the unit for defibrillation when the patient

- Is conscious
- Is breathing, or
- Has a detectable pulse or other sign of circulation.

## **General Information**

Federal (U.S.A.) law restricts this defibrillator to sale by or on the order of a physician.

## About This Manual

The issue date for the ZOLL AED 3 Operator's Manual (REF 9650-000750-01-50 Rev. 2) is **December, 2017**.

Copyright © 2017 ZOLL Medical Corporation. All rights reserved. CPR-D-padz, Pedi-padz, PlusTrac, Program Management Onboard, Real CPR Help, Rectilinear Biphasic, RescueNet, Stat-padz, ZOLL, and ZOLL AED 3 are trademarks or registered trademarks of ZOLL Medical Corporation in the United States and/or other countries. All other trademarks and registered trademarks are the property of their respective owners.



**ZOLL Medical Corporation**  
269 Mill Road  
Chelmsford, MA USA  
01824-4105



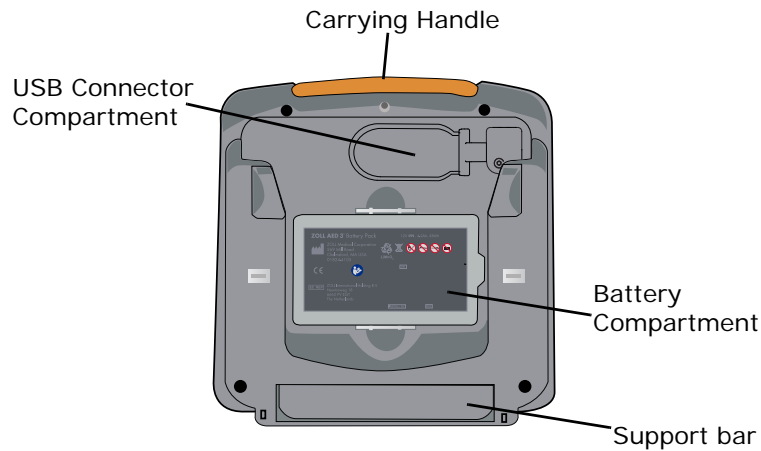
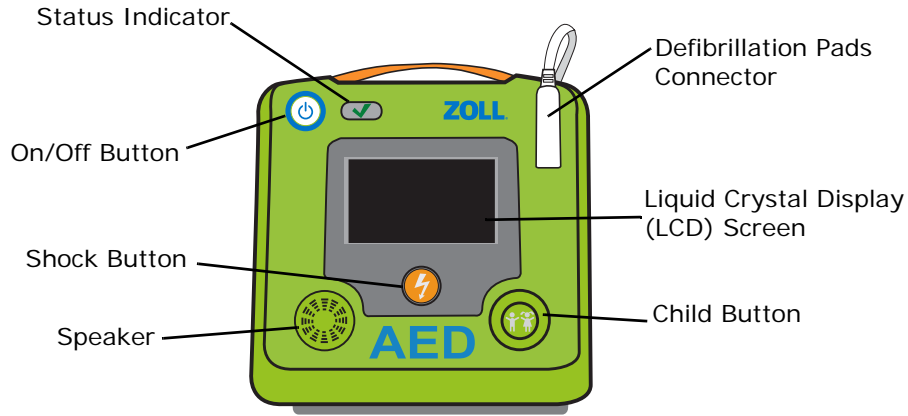
**ZOLL International Holding B.V.**  
Newtonweg 18  
6662 PV ELST  
The Netherlands



0123



# ZOLL AED 3™ Controls and Indicators

See “ZOLL AED 3 Control Functions” on the following page for a description of each of these controls.





**Table 1: ZOLL AED 3 Control Functions**

Control/Indicator	Function
Status Indicator  AED Passed Self Test  AED Failed Self Test	A green check indicates that the ZOLL AED 3 defibrillator passed its last self test and is ready for use. No green check indicates that the AED has not passed its last self test or a battery has not been installed—see note on page 11 for more information.
On/Off Button	Press to turn power ON or OFF.
Shock Button	Illuminates when the AED is charged and ready to deliver a shock to the patient. When pressed, it causes the AED to discharge its energy into the patient. <b>Note:</b> In <i>Automatic</i> models, the shock button does not illuminate.
Speaker	Provides audio prompts and metronome beeps to guide rescuers during a rescue; also provides audio prompts to indicate when service is required.
Defibrillation Pads Connector	This connector is used to attach the defibrillation pads to the ZOLL AED 3 defibrillator.
Liquid Crystal Display (LCD) Screen	A 2.1 x 3.7 inch touch screen for display and user input. During a rescue, it displays graphics to guide the rescuer.
Child Button	Illuminated button indicates the ZOLL AED 3 is in Child Mode in preparation for rescuing a pediatric patient. Automatically lights up while using Pedi-padz II.
Carrying Handle	The strap designed to make it easy to carry the AED.
USB Connector Compartment	The area used to connect a USB flash drive when importing/exporting files to or from the ZOLL AED 3 defibrillator.
Battery Compartment	Holds the battery pack used to power the AED.
Support Bar	Opens to hold the AED in an upright position.



# Table of Contents

## **Introduction**

Overview .....	1
Intended Users .....	2
Conventions .....	2
Safety Summary .....	3
Warnings .....	3
Cautions .....	6

## **Setting Up the ZOLL AED 3 Defibrillator**

ZOLL AED 3 Shipping Contents .....	8
Setting Up the Defibrillator .....	9
Important Notes .....	11

## **Using the ZOLL AED 3 Defibrillator**

Overview .....	12
When a Shock is Needed .....	14
When a Shock is Not Needed .....	15
ECG/CPR Dashboard .....	15
When Emergency Medical Services Arrive .....	16
After Using the ZOLL AED 3 .....	16

## **Maintaining the ZOLL AED 3 Defibrillator**

Overview .....	17
After Each Use .....	17
Cleaning the ZOLL AED 3 Defibrillator .....	18
Replacing the Battery Pack .....	19
Self Tests .....	21

Automatic Self-Test Transfer .....	22
Troubleshooting.....	23
Contacting Technical Service .....	25
International Customers .....	25
<b>Transferring Patient Data</b>	
Overview .....	26
Exporting Patient Files .....	26
Using ZOLL RescueNet Code Review Software.....	28
Using Case Review Software .....	28
Troubleshooting Communication Issues .....	29
<b>Appendix A</b>	
Symbols .....	30
<b>Appendix B</b>	
Specifications.....	34

# Introduction

## Overview

The ZOLL AED 3™ defibrillator is an Automated External Defibrillator (AED) that is designed to be used for both adult and child victims of sudden cardiac arrest. It uses audio and visual prompts to guide the rescuer through a resuscitation sequence that may include defibrillation and/or cardiopulmonary resuscitation (CPR). The defibrillator provides Real CPR Help® corrective rate and depth prompting for adult victims and an active metronome for both adult and child victims. The ZOLL AED 3 defibrillator incorporates the ZOLL® Rectilinear Biphasic™ Defibrillation waveform, and operates in either adult or child mode.

The ZOLL AED 3 defibrillator is available in three models: ZOLL AED 3, ZOLL AED 3 *Automatic*, and ZOLL AED 3 *BLS*. The ZOLL AED 3 and ZOLL AED 3 *BLS* models function in semi-automatic mode where the rescuer initiates the shock. The ZOLL AED 3 *Automatic* model automatically initiates the shock without rescuer intervention.

The defibrillator has two operating modes: Rescue Mode and AED Management Mode. In Rescue Mode, the LCD screen displays graphics that are coordinated with audio prompts to guide you through a rescue. In AED Management Mode, the icons on the touch screen allow you to change configuration settings and upload files.

## Intended Users

The ZOLL AED 3 defibrillator is intended to be used by responders who have been trained in CPR and the use of an AED to defibrillate victims of cardiac arrest. The CPR monitoring function provides a metronome designed to encourage rescuers to perform chest compressions at the recommended rate of at least 100 compressions per minute for both adult and child victims. The defibrillator provides voice and visual prompts to encourage a minimum compression depth of 2 inches for adult victims and basic instructions for child victims.

## Conventions

Throughout this document, text prompts and voice prompts are indicated by capital italicized letters, such as *CALL FOR HELP*.

**WARNING!** Warning statements describe conditions or actions that can result in personal injury or death.

**CAUTION** Caution statements describe conditions or actions that can result in damage to the device.

**NOTE** Notes contain important additional information about using the defibrillator.

# Safety Summary

The following section describes general warnings and safety considerations for administrators, rescuers, and victims.



## Warnings

- Use the ZOLL AED 3 defibrillator only as described in this manual. Improper use of the AED can cause death or injury.
- DO NOT use or place the defibrillator in service until you have read the *ZOLL AED 3 Operator's Manual*.
- DO NOT use or place the ZOLL AED 3 defibrillator in service if the green check (✓) is not displayed in the AED's status indicator window (located to the right of the On/Off button). The green check displays when the AED is ready to use.
- DO NOT use or place the ZOLL AED 3 defibrillator in service if the unit emits a beeping tone when it is off.
- DO NOT perform any unauthorized modification to the ZOLL AED 3 defibrillator.
- DO NOT disassemble the unit. A shock hazard exists. Refer all servicing to qualified personnel.
- The ZOLL AED 3 defibrillator is not intended for use in fixed or rotary wing aircraft.
- Connect the defibrillation pads cable to the defibrillator BEFORE installing the battery pack.
- Keep the defibrillation pads cable connected to the defibrillator at all times.
- The ZOLL AED 3 defibrillator should only be used by properly trained individuals.
- Use the ZOLL CPR Stat-padz<sup>®</sup> defibrillation pads for adult victims. The ZOLL Pedi-padz<sup>®</sup> II defibrillation pads may be used on children less than 8 years old or weighing less than 55 lbs (25 kg).

- The ZOLL AED 3 defibrillator is capable of delivering 200 joules. If necessary, the defibrillator can be completely deactivated by turning it off and removing the battery pack.
- For safety, the semi-automatic version of the ZOLL AED 3 defibrillator automatically disarms a fully charged unit after 30 seconds if the Shock button is not pressed.
- Always stand clear of the victim when delivering a shock. Defibrillation energy delivered to the victim may be conducted through the victim's body and cause a lethal shock to those touching the victim.
- DO NOT TOUCH the defibrillation pad surfaces, the victim, or any conductive material touching the victim during ECG analysis or defibrillation.
- Move the victim away from electrically conductive surfaces prior to use of equipment.
- DO NOT use the ZOLL AED 3 defibrillator near or within puddles of water.
- Keep the victim as motionless as possible during ECG analysis.
- DO NOT use the ZOLL AED 3 defibrillator near flammable agents, such as gasoline, oxygen-rich atmospheres or flammable anesthetics.
- MR Unsafe - Keep the ZOLL AED 3 defibrillator away from magnetic resonance imaging (MRI) equipment.
- Turn off cell phones and two-way radios to avoid radio frequency interference from high-power sources that might cause the defibrillator to interpret cardiac rhythms incorrectly.
- Disconnect non-defibrillation protected electronic devices or equipment from victim before defibrillation.
- Dry victim's chest, if wet, before attaching defibrillation pads.
- Apply freshly opened and undamaged defibrillation pads (within the defibrillation pads expiration date) to clean and dry skin to minimize burning.



- DO NOT place the defibrillation pads directly over a victim's implanted pacemaker. Pacemaker stimuli may degrade the accuracy of ECG rhythm analyses, or the pacemaker may be damaged by defibrillator discharges.
- The ZOLL AED 3 defibrillator does not reject implanted pacemaker pulses.
- DO NOT disassemble a battery pack or dispose of it in fire. DO NOT try to recharge the nonrechargeable battery pack. If mishandled, the battery pack may explode.
- DO NOT use or stack the ZOLL AED 3 defibrillator with other equipment. If the defibrillator must be used or stacked with other equipment, verify proper operation prior to use.
- DO NOT connect the ZOLL AED 3 defibrillator to a computer or other device (using the USB port) while the defibrillation pads are still connected to the victim.
- The ZOLL AED 3 USB port is intended for use with a flash drive only. DO NOT insert wireless adapters or other unauthorized devices into the USB port.
- Check the expiration date on the defibrillation pads packaging. DO NOT use defibrillation pads that have passed their expiration date.
- The use of accessories and cables other than those specified in the *ZOLL AED 3 Administrator's Guide* may result in increased emissions or decreased immunity of the ZOLL AED 3 defibrillator.

- To satisfy FCC RF exposure requirements for mobile transmitting devices, a separation distance of 20 cm or more should be maintained between the antenna of this device and persons during device operations. To ensure compliance, operations at closer than this distance are not recommended. The antenna (located internally in top front of device) used for this transmitter must not be co-located in conjunction with any other antenna or transmitter.



## Cautions

- The ZOLL AED 3 defibrillator may not perform to specifications when stored at the upper or lower extreme limits of storage temperature and then immediately put into use.
- Use only the ZOLL AED 3 nonrechargeable, disposable battery pack with the ZOLL AED 3 defibrillator.
- Keep a new spare battery pack with the device at all times.
- When the unit displays the *CHANGE BATTERY* message, replace the battery pack with a new one as soon as possible.
- Dispose of battery packs in accordance with federal, state, and local regulations. Battery packs should be shipped to a reclamation facility for recovery of metal and plastic compounds as the proper method of waste management.
- ZOLL defibrillation pads contain no hazardous materials and may be disposed of in general trash unless contaminated with pathogens. Use appropriate precautions when disposing of contaminated defibrillation pads.
- If the ZOLL AED 3 defibrillator is stored outside the recommended environmental conditions, the defibrillation pads and/or battery pack may be damaged or their useful life reduced.

- Safety and effectiveness data submitted by ZOLL Medical Corporation to the Food and Drug Administration (FDA) to obtain approval to market are based upon the use of ZOLL accessories such as disposable defibrillation pads and batteries. The use of defibrillation pads and batteries from sources other than ZOLL is not recommended. ZOLL makes no representations or warranties regarding the performance or effectiveness of its products when used in conjunction with defibrillation pads and batteries from other sources. If AED failure is attributable to the use of accessories not manufactured by ZOLL, this may void ZOLL's warranty.
- When Stat-padz II and Pedi-padz II are connected to the ZOLL AED 3 defibrillator, the device only produces a constant metronome during CPR intervals; it does not provide Real CPR Help.
- Prior to use, assess Wi-Fi performance for possibility of Radio Frequency Interference (RFI) in your environment of use.
- The ZOLL AED 3 defibrillator is suitable for use in all professional and domestic establishments. It is not intended for use near intentional transmitters of radio energy outside the ranges stated in the above table, such as high frequency surgical equipment, radar installations, or radio transmitters. It is also not intended for use in fixed or rotary wing aircraft. Operation outside of this environment could result in the misinterpretation of the ECG rhythms or CPR signals, interference to the display or audio messages, or the inability to provide defibrillation therapy.
- If multiple devices are transmitting simultaneously to the same access point, Wi-Fi data transfer slows down. If the access point is too overloaded, data transmission failures may occur.

# Setting Up the ZOLL AED 3 Defibrillator

## ZOLL AED 3 Shipping Contents

Check the ZOLL AED 3 shipping container for the following contents:

- 1 ZOLL AED 3 defibrillator
- 1 ZOLL AED 3 battery pack
- 1 package containing defibrillation pads (with scissors attached)
- 1 ZOLL AED 3 documentation packet

**NOTE** If the contents are incomplete or damaged, contact ZOLL Medical Corporation's Technical Service Department. See "Contacting Technical Service" on page 25 for more information.



AED Passed  
Self Test



AED Failed  
Self Test

**NOTE** If the ZOLL AED 3 defibrillator fails to pass its self test (indicated by a *UNIT FAILED* prompt or if the green check is not displayed in the status indicator window) after installing a new battery, make sure the defibrillation pads are plugged in properly.

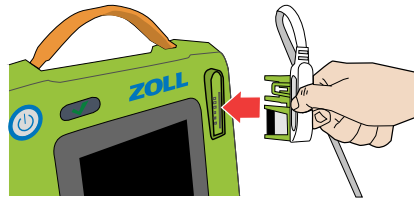
# Setting Up the Defibrillator

Follow the steps below to prepare the ZOLL AED 3 defibrillator for use.

1. Remove the defibrillation pads package from the cardboard box in the shipping container.

**WARNING! Do not open sealed defibrillation pads until immediately prior to use.**

2. Plug the defibrillation pads cable connector into the defibrillation pads port.

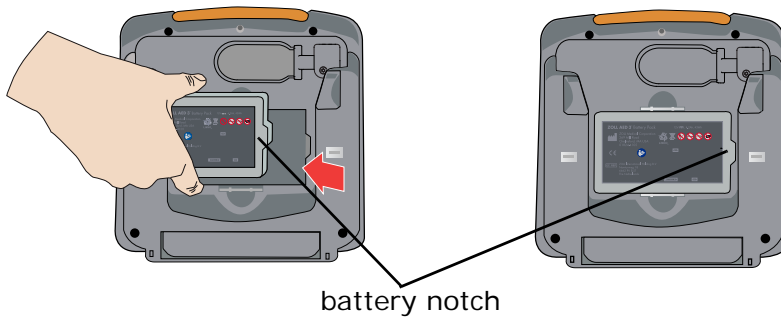


Plug in defibrillation pads cable connector

**WARNING! To prepare for an emergency, keep the defibrillation pads cable connected to the AED at all times. Do not reuse defibrillation pads.**

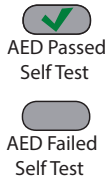
3. Remove the battery pack from the shipping container.
4. Hold the battery pack by the side tabs with the label facing out. Insert the battery pack into the back of the AED until it clicks into place, lining up the notch on the end of the battery to the corresponding recess in the battery well.

The defibrillator runs an automatic self test.



**WARNING! To ensure the ZOLL AED 3 defibrillator is ready for use, monitor its status weekly. Verify that the AED has passed its periodic self test by confirming the green check is displayed in the status indicator window.**

5. While facing the front of the defibrillator, insert the defibrillation pads package into the back of the AED so that the label on the package is facing you with the defibrillation pads cable on the right.



6. Verify that the green check (✓) appears in the status indicator window and that the defibrillator does not emit a beeping tone. This indicates that the new battery pack and defibrillation pads are properly installed and the ZOLL AED 3 defibrillator is ready for use.

**NOTE** If the defibrillator fails to pass its self test (the green check does not display in the status window or it issues the *UNIT FAILED* audio prompt) after battery installation, remove the battery and unplug the defibrillation pads and repeat steps 2 through 6. If the AED fails to pass its self test a second time, contact ZOLL Medical Corporation's Technical Service Department. See "Contacting Technical Service" on page 25 for more information.

7. Place the defibrillator into service in accordance with your local guidelines and hang the rescue poster on the wall near the defibrillator.

**NOTE** The ZOLL AED 3 defibrillator ships with a default Supervisor passcode (which is published in the ZOLL AED 3 Administrator's Guide). The AED Administrator should change the default passcode after the set up of the device is complete. See [www.zoll.com](http://www.zoll.com) for the latest version of the ZOLL AED 3 Administrator's Guide.

## Important Notes

- Make sure the defibrillation pads are always connected to the defibrillator and the battery is installed.
- To ensure adequate power availability during an emergency, monitor the device status weekly or per local guidelines. Verify that the AED has passed its periodic self test by confirming that the green check is displayed in the status indicator window.
- If you change the battery while the AED is in Rescue Mode (with the defibrillation pads cable connected), the AED automatically powers on displaying the battery icon and then shuts down. Press and release the On/Off button to restart the AED.

# Using the ZOLL AED 3 Defibrillator

## Overview

Use the ZOLL AED 3 defibrillator when a suspected cardiac arrest victim has an apparent lack of circulation as indicated by ALL of the following symptoms:

- Unconsciousness
- Absence of normal breathing
- Absence of a pulse or signs of circulation

Call for help, retrieve the defibrillator, and bring it to the patient's side. Follow the basic steps on the following pages to treat the suspected cardiac arrest patient:

1. Press the On/Off button to turn on the defibrillator and follow the voice prompts.
2. Place defibrillation pads on the patient (follow the defibrillator's voice prompts).
3. Shock patient, if instructed.
4. Start CPR.



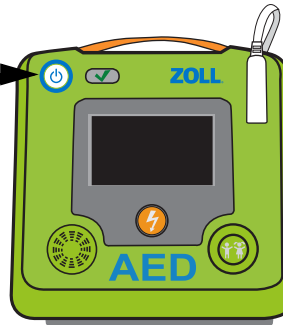
## STEP 1 Turn on ZOLL AED 3 Defibrillator

Press the On/Off button in the upper left corner of the AED to turn it on.



On/Off  
button

On/Off button →



## STEP 2 Place defibrillation pads on patient

The ZOLL AED 3 defibrillator instructs you to:

- Remove the pad package from the back of the defibrillator and open the package.
- Remove all clothing from the patient's chest. Use the scissors located on the defibrillation pads package to cut clothing, if needed.

Ensure that the patient's chest is clean and dry. If the patient has excessive chest hair, clip or shave the chest hair.

- Remove the adhesive liner from the defibrillation pads and place them according to the illustrations on the package.






**WARNING! Poor adherence or air pockets under the defibrillation pads can lead to arcing, skin burns, or reduced energy delivery. To minimize burning, apply freshly opened and undamaged defibrillation pads to clean and dry skin. Do not fold or wrinkle the defibrillation pad gel surface when applying defibrillation pads to the patient.**

The AED issues the voice and text prompt, *DON'T TOUCH PATIENT, ANALYZING* and then begins ECG analysis.

## STEP 3 Shock the Patient

**WARNING! DO NOT touch defibrillation pad surfaces, the patient, or any conductive material touching the patient during ECG analysis or defibrillation.**

### When a Shock is Needed

ZOLL AED 3/ZOLL AED 3 <i>BLS</i>	ZOLL AED 3 <i>Automatic</i>
<p><b>You hear:</b> Charge-ready tone <i>DON'T TOUCH PATIENT. PRESS FLASHING SHOCK BUTTON.</i></p>	<p><b>You hear:</b> <i>DON'T TOUCH PATIENT. SHOCK WILL BE DELIVERED IN THREE, TWO, ONE.</i></p>
<p><b>You see:</b></p> 	<p><b>You see:</b></p> <p>First screen: </p> <p>Second screen: </p> <p>Third screen: </p>
<p><b>Do this:</b> Press flashing shock button.</p>  <p>Shock button</p>	<p><b>Do this:</b> Stand clear. (The AED automatically shocks the patient).</p>

AED announces *SHOCK DELIVERED*.

Once the shock has been delivered, the AED provides CPR guidance and continuing ECG analysis to determine if more shocks are needed.

## **When a Shock is Not Needed**

If the AED determines that a shock is not needed, a voice prompt instructs you to start CPR for a period of time (configured by the AED Administrator), after which the AED automatically initiates a new ECG analysis. If a shock is needed at that time, refer to “When a Shock is Needed” on page 14.

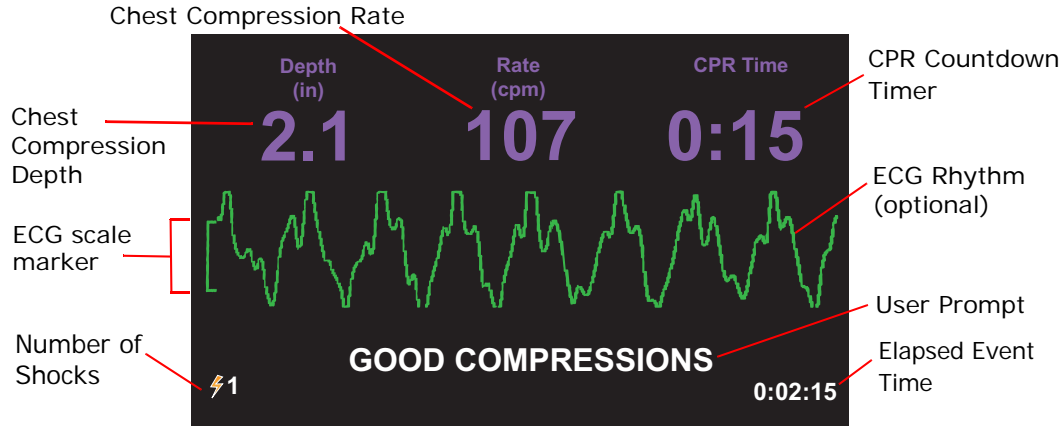
### **STEP 4 Start CPR**

Place your hands on the CPR compression sensor. Listen to the metronome and follow the AED’s instructions. If the patient is an adult, follow the audio prompts that provide feedback on the depth and the metronome rate for CPR chest compressions. The CPR Countdown Timer displays the time left in the current CPR period. Continue to follow the AED’s voice instructions until help arrives.

## **ECG/CPR Dashboard**

If configured and using CPR Stat-padz or CPR-D-padz<sup>®</sup>, the ZOLL AED 3 *BLS* model can display the CPR Dashboard, with or without the ECG waveform. The CPR Dashboard display shows the Chest Compression Rate, the Chest Compression Depth, and the CPR remaining time until the next ECG analysis starts.

**NOTE** All models of the ZOLL AED 3 defibrillator display the CPR Countdown Timer.



## When Emergency Medical Services Arrive

When Emergency Medical Services (EMS) arrive, you can provide the following rescue information:

- Shock delivered count (bottom left of the display screen)
- Elapsed Event time (bottom right of the display screen)

You can transfer the patient event data to a USB flash drive if EMS personnel request the information. See “Exporting Patient Files” on page 26 for more information.

## After Using the ZOLL AED 3

See “After Each Use” on page 17 for maintenance instructions to perform after each time the defibrillator is used.

# Maintaining the ZOLL AED 3 Defibrillator

## Overview

The ZOLL AED 3 defibrillator requires little maintenance. It automatically performs a self test every time you turn on the AED or install a battery, and it also performs a routine self test based on the interval of days that you specify (default is 7 days). The defibrillator collects the self test information in its device history, and performs the following self tests:

- Battery Installation Self Test
- Power On Self Test
- Manual Self Test
- Automatic Self Test
- Automatic Monthly Self Test

This section contains procedures on how to maintain the defibrillator as well as some general information about the self tests. There is also a table containing the most common errors and how to fix them. See the *ZOLL AED 3 Administrator's Guide* for additional maintenance information (intended for qualified technical professionals).

## After Each Use

Perform the following steps after each time the AED is used.

1. Check that the AED is clean, undamaged, and free of excessive wear. If the AED needs to be cleaned, see "Cleaning the ZOLL AED 3 Defibrillator" on page 18.

2. Obtain a new set of defibrillation pads (verify that the expiration date has not passed) and connect the defibrillation pads to the defibrillator. See steps 1 to 3 in the procedure, “Setting Up the Defibrillator” on page 9 for more information.
3. Run a manual self test by pressing and holding the defibrillator’s On/Off button for at least 5 seconds.

If AED Displays	Then
<i>CHANGE BATTERY</i> message	Replace the battery pack (see “Replacing the Battery Pack” on page 19), then go to step 5.
<i>UNIT OK</i> message	Go to step 4.

4. Press the On/Off button to power off the unit.
5. Place the defibrillator back into service so that it is ready for use.

## Cleaning the ZOLL AED 3 Defibrillator

After each use, clean and disinfect the defibrillator with a soft, damp cloth using either 90% isopropyl alcohol, or soap and water. You can also use a chlorine bleach and water mixture (30 ml/liter water) to clean the defibrillator (except on the contacts and connectors).

**NOTE** Wipe down the defibrillator with water after using any cleaning solution. Chlorine residue that remains on the LCD screen may damage it.

### DO NOT:

- Immerse any part of the defibrillator in water.
- Use chlorine mixture on contacts or connectors; this will degrade the contacts over time.
- Use ketones (MEK, acetone, etc.) to clean the defibrillator.
- Use abrasives (e.g., paper towel) on the display window or graphic screen.
- Sterilize the defibrillator.

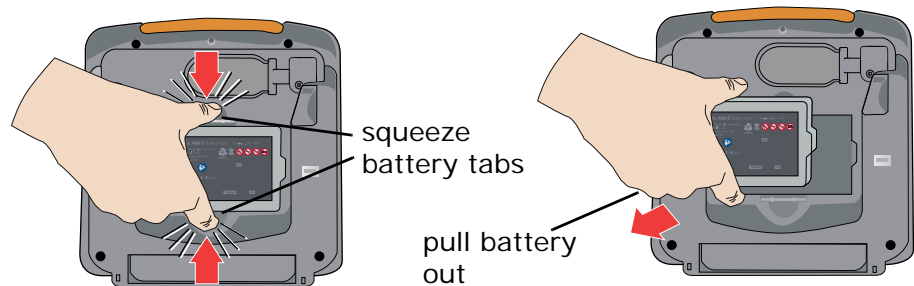
## Replacing the Battery Pack

When the defibrillator displays the *CHANGE BATTERY* message, replace the battery with a new battery pack as soon as possible. Before replacing a battery pack, verify that the defibrillator is turned off and the battery pack being installed has not passed its "install by" date.

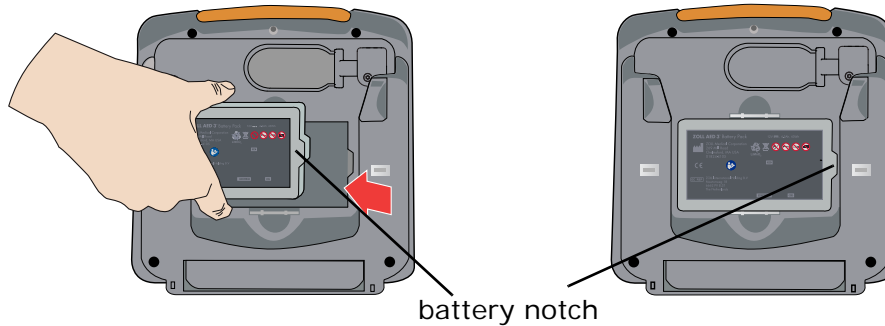
**WARNING!** To ensure the ZOLL AED 3 defibrillator is ready for use, monitor its status weekly. Verify that the AED has passed its periodic self test by confirming the green check is displayed in the status indicator window.

1. Place your fingers in the wells of the battery compartment and squeeze the battery side tabs to pull out the battery.

**NOTE** Properly dispose of the old battery.



2. Hold the new battery pack by the side tabs and insert it into the back of the AED, lining up the notch on the end of the battery with the corresponding shape in the battery well until it clicks into place.



The AED issues a *BATTERY REPLACED* prompt and automatically initiates a self test.

3. Verify that the ZOLL AED 3 defibrillator issues the *UNIT OK* voice prompt and that the green check (✓) appears in the status indicator window. This prompt indicates that the new battery pack and defibrillation pads are properly installed and that the AED is ready for service.



## Self Tests

The ZOLL AED 3 defibrillator performs the following self tests to verify unit integrity and its readiness for emergency use. See the *ZOLL AED 3 Administrator's Guide* for more detailed information about these tests.

**Table 2: ZOLL AED 3 Self Tests**

Self Test	When Performed	Functions Performed
Battery Installation	Automatically, after battery pack is installed or replaced.	<p><b>Basic functions:</b></p> <ul style="list-style-type: none"> <li>• Battery Capacity</li> <li>• Defibrillation Pads Connection</li> <li>• Defibrillation Pads/ Battery Expiration Verification</li> <li>• ECG Circuitry</li> <li>• Defibrillator Charge and Discharge Circuitry (2 Joule Test)</li> <li>• Microprocessor Hardware/Software</li> <li>• CPR Circuitry and Sensor (if defibrillation pads with CPR functionality are connected)</li> <li>• Audio Circuitry</li> </ul> <p><b>Additional function:</b></p> <ul style="list-style-type: none"> <li>• 200 Joule Charge Test</li> </ul>
Power On	Automatically, whenever the AED is turned on.	<p><b>Basic functions:</b></p> <p>Same as Battery Installation Self Test basic functions.</p>
Manual	By pressing and holding the AED's On/Off button for at least 5 seconds.	<p><b>Basic functions:</b></p> <p>Same as Battery Installation Self Test basic functions.</p> <p><b>Additional function:</b></p> <ul style="list-style-type: none"> <li>• 200 Joule Charge Test</li> </ul>

Self Test	When Performed	Functions Performed
Automatic	Once every 7 days (this interval can be configured to once a day) when the AED is stored with battery pack installed.	<b>Basic functions:</b> Same as Battery Installation Self Test basic functions.
Automatic Monthly	Once per month when the AED is stored with battery pack installed.	<b>Basic functions:</b> Same as Battery Installation Self Test basic functions. <b>Additional function:</b> <ul style="list-style-type: none"> <li>• 200 Joule Charge Test</li> </ul>

When the defibrillator successfully completes its automatic self tests, the device displays a green check (✓) in the status indicator window to show that all tests passed and that it is ready to use. If the defibrillator does not display a green check in the status indicator window following the completion of any self test, the ZOLL AED 3 defibrillator is not ready for use and may be defective. Remove the defibrillator from service and consult “Troubleshooting” on page 23 to determine the problem.

## Automatic Self-Test Transfer

All ZOLL AED 3 defibrillators come standard with Program Management Onboard™ intelligent monitoring technology to transfer self-test data. If configured, the AED can automatically transfer self-test information over Wi-Fi to the PlusTrac™ AED program management system or to another AED program management provider.

## Troubleshooting

The following table lists error indications that may occur on the ZOLL AED 3 defibrillator, and the associated corrective action. For a more extensive list of error messages, see the *ZOLL AED 3 Administrator's Guide*. If the defibrillator is not working properly, contact ZOLL's Technical Service Department for assistance. See "Contacting Technical Service" on page 25 for more information.

**Table 3: ZOLL AED 3 Error Messages**

Technical Problem	Recommended Action
<i>UNIT FAILED</i> prompt	Initiate manual self test by pressing and holding the On/Off button for more than 5 seconds. Check to see if the defibrillation pads cable is attached properly to the defibrillator or replace the defibrillation pads. Cycle power on the defibrillator by turning the AED off, and then on again. Replace the battery pack. If the defibrillator still does not operate correctly, remove the AED from service and contact ZOLL Technical Service (see "Contacting Technical Service" on page 25).
Beeping noise when AED is off	Check to see if the defibrillation pads cable is attached properly to the defibrillator or replace the defibrillation pads. Remove the defibrillator from service and replace the battery pack. If beeping continues, contact ZOLL Technical Service (see "Contacting Technical Service" on page 25).
Loss of audio prompts or display	Cycle power on the defibrillator by turning the AED off, and then on again. If the AED continues to fail, contact ZOLL Technical Service (see "Contacting Technical Service" on page 25).

Technical Problem	Recommended Action
Green check does not appear in the status indicator window	Initiate manual self test by pressing and holding the On/Off button for more than 5 seconds. Check to see if the defibrillation pads cable is attached properly to the defibrillator or replace the defibrillation pads. Replace the battery pack. If the defibrillator fails the test again, remove the AED from service and contact ZOLL Technical Service (see "Contacting Technical Service" on page 25).
<i>CHANGE BATTERY</i> prompt	Replace the battery pack.
<i>PLUG IN PADS CABLE</i> prompt	Check cable connection between defibrillation pads and the defibrillator.
<i>ATTACH CORRECT DEFIB PADS</i> prompt	Incompatible defibrillation pads are connected to the AED. Use one of the following pads: <ul style="list-style-type: none"> <li>• CPR-D-padz</li> <li>• CPR Stat-padz</li> <li>• Stat-padz II</li> <li>• Pedi-padz II</li> </ul>
<i>ANALYSIS HALTED. KEEP PATIENT STILL</i> prompt	Excessive artifact is detected during ECG analysis. The patient must be motionless during ECG analysis. Do not touch the patient during this analysis and keep the patient still. If you are using the defibrillator in an emergency vehicle, bring the vehicle to a halt before performing ECG analysis.
<i>RELEASE SHOCK BUTTON</i> prompt	Release the shock button, then press and hold the shock button (when button is illuminated) until discharge occurs. If the voice prompt continues, contact ZOLL Technical Service (see "Contacting Technical Service" on page 25).

## Contacting Technical Service

If a ZOLL product requires service, contact the ZOLL Technical Service Department or the nearest ZOLL sales office or distributor:

Telephone: 1-978-421-9655

Toll free: 1-800-348-9011

Fax: 1-978-421-0010

Email: techsupport@zoll.com

Have the following information available for the Technical Service representative:

- Serial number
- Description of the problem

If you need to send the ZOLL AED 3 defibrillator to ZOLL Medical Corporation, obtain a service order request number from the Technical Service representative.

**NOTE** Before sending the defibrillator and battery to ZOLL, check with your local shipping company to see if there are any restrictions on shipping lithium batteries.

Remove the battery pack from the defibrillator and return the AED and battery pack in its original container (or equivalent packaging) with the service order request number on it to the following address:

ZOLL Medical Corporation  
269 Mill Road  
Chelmsford, MA 01824-4105  
Attn: Technical Service Department

## International Customers

Customers outside of the United States should remove the battery pack from the AED and return the AED and battery pack in its original container (or equivalent packaging) to the nearest authorized ZOLL Medical Corporation Service Center. To locate an authorized service center, contact the nearest ZOLL sales office or authorized distributor.

# Transferring Patient Data

## Overview



Device  
Configuration  
icon

In order to transfer data, the AED must be in AED Management Mode.

To enter AED Management Mode, press and hold the On/Off button for at least 5 seconds, then press the Device Configuration icon on the main display screen. While the unit is in AED Management Mode, you can export data at any time to a USB flash drive or a wireless access point.

The ZOLL AED 3 defibrillator automatically stores patient clinical data with date and time notation. You can access this data and transfer it to a remote device (such as a computer) using either a USB flash drive or a wireless connection. You can then view and analyze this information using ZOLL RescueNet<sup>®</sup> Code Review software or ZOLL RescueNet Case Review software through ZOLL Online.

**NOTE** The AED retains the clinical event data even when powered off or when the battery pack is removed. When the AED is powered on and defibrillation pads are attached to a new patient, new clinical data replaces the old clinical data if the AED has already stored data for one or two patients (default is two).

## Exporting Patient Files

Use the following procedure to transfer patient files (clinical data) from the ZOLL AED 3 defibrillator.

**NOTE** You do not need Supervisor access to export data files to a USB flash drive or wireless access point.

**NOTE** When transferring files via USB, the USB flash drive must be USB 1.1 or 2.0 compliant.

In order to transfer data via a wireless connection, you need to create a wireless profile. If you have not already done so, see *Setting up Your Wireless Configuration* in the *ZOLL AED 3 Administrator's Guide*.

**WARNING! Do not connect the ZOLL AED 3 defibrillator to a computer or other device (via the USB port) while the defibrillation pads are still connected to the patient.**



Device  
Configuration  
icon



USB icon



Export Files  
icon

- 1 Press and hold the On/Off button for longer than 5 seconds, then press the Device Configuration icon to enter AED Management Mode.
2. If you are transferring data:
  - Using a wireless connection, go to step 3.
  - Using a USB flash drive, insert the flash drive into the USB connector on the back of the AED. The USB icon appears in the status bar at the bottom of the display screen.
3. Press the Export Files icon and select one of the following clinical patient file options:
  - *Clinical Archives (all)* -- includes up to two stored patient files.
  - *Clinical Archives (new)* - includes the most recent stored patient file.

A green check displays next to the option you have selected.

4. Press **Save (USB)** or **Send (Wi-Fi)**. When the AED has finished transferring data, it displays the prompt, *DATA TRANSFER COMPLETE*.

You can transfer clinical archives (patient data) for use with ZOLL RescueNet Code Review software or Case Review software (over Wi-Fi using ZOLL Online).

## Using ZOLL RescueNet Code Review Software

ZOLL RescueNet Code Review software allows you to analyze resuscitation incident information from the defibrillator and perform the following functions:

- Access and review patient event information.
- Add or modify patient information.
- View animated versions of ECG traces.
- Annotate ECG traces.
- Print ECG stripcharts and case reports.

Visit [www.zolldata.com/c-r-downloads/](http://www.zolldata.com/c-r-downloads/) to download the latest version of RescueNet Code Review Software and corresponding documentation.

## Using Case Review Software

Case Review software is a cloud-based clinical data management and quality reporting system that is hosted in ZOLL Online. Using its Wi-Fi capability, the ZOLL AED 3 can be configured to transmit clinical event data over Wi-Fi to ZOLL Case Review. When using Case Review software to manage clinical event data, you can perform the following functions:

- Collect clinical files to a single destination.
- Make data easily available to a clinical quality team.
- Review quality of CPR directly from the web.
- View trends in CPR quality and data movement.

Visit [www.zollonline.com](http://www.zollonline.com) for more information.



## Troubleshooting Communication Issues

The following table summarizes common communication messages you may see when exporting patient data, and their associated description and/or recommended action. If the ZOLL AED 3 defibrillator is not working properly, contact ZOLL's Technical Service Department for assistance. See "Contacting Technical Service" on page 25 for more information.

**Table 4: ZOLL AED 3 Patient Data Messages**

Message	Description/Recommended Action
<i>CLINICAL ARCHIVE UNAVAILABLE</i>	There are no clinical archive files (.crd) available to export.
<i>DATA TRANSFER COMPLETE</i>	The data transfer through Wi-Fi is finished.
<i>UNABLE TO EXPORT REQUESTED FILE. INTERNAL ERROR.</i>	The file export was not successful. Verify the Wi-Fi configuration and try the export operation again.
<i>UNABLE TO SAVE FILES. PLEASE ENSURE THAT AN EMPTY USB FLASH DRIVE IS SECURELY INSERTED INTO THE DEVICE.</i>	The AED cannot save the files to the USB flash drive. Verify that there is sufficient space to export the file(s) to the USB flash drive, and that the flash drive is inserted properly into the unit.
<i>UNABLE TO TRANSMIT REQUESTED FILE</i>	The attempt to export the file to the USB flash drive was unsuccessful. Try the file transfer again.
















# Appendix A











## Symbols






Any or all of the following symbols may be used in this manual or on this equipment:

**Table 5: Symbols**

Symbol	Description
	Power On/Off.
	Child button.
	Shock button.
	Warning: Dangerous voltage.
	Fragile, handle with care.
	Keep dry.
	This end up.
	Temperature limitation.

Symbol	Description
<b>Rx ONLY</b>	Federal law restricts this device to sale by or on the order of a physician.
	<b>Conformité Européenne</b> Complies with medical device directive 93/42/EEC.
	This product has been certified by the Australian Communication and Media Authority.
	Complies with the Federal Communications Commission.
	Defibrillator-proof type BF equipment.
	Contains lithium. Recycle or dispose of properly.
	Keep away from open flame and high heat.
	Do not open, disassemble, or intentionally damage.
	Do not crush.
	Non-rechargeable battery.

Symbol	Description
	Return to a collection site intended for waste electrical and electronic equipment (WEEE). Do not dispose of in unsorted trash.
	Use by.
	Latex-free.
	Do not reuse.
	Not sterile.
	Nonionizing electromagnetic radiation.
	Manufacturer.
	Authorized representative in the European Community.
	Serial Number.
	Catalog number.

Symbol	Description
	MR Unsafe - keep away from magnetic resonance imaging (MRI) equipment.
	Batch code.
	Consult instructions for use.
	Refer to manual.
	Use by date.
<b>IP55</b>	Protected against dust ingress. Protected against jetting water.

# Appendix B

## Specifications

This section describes the following product specifications for the ZOLL AED 3 defibrillator.

**Table 6: General Specifications**

Device	
Size (H x W x D)	5.0" x 9.3" x 9.7" (12.7 cm x 23.6 cm x 24.7 cm)
Weight	5.5 lbs.; 2.5 kg
Environment	
Operating Temperature	32° to 122° F; 0° to 50° C
Storage Temperature	-22° to 158° F; -30° to 70° C
Humidity	10 to 95% relative humidity, non-condensing
Vibration	IEC 60068-2-64, Random, Spectrum A.4, Table A.8, Cat. 3b; RTCA/DO-160G, Fixed Wing Aircraft, Section 8.6, Test Cat. H, Aircraft Zone 1 and 2; EN1789, Sweep per EN 60068-2-6 Test Fc
Shock	IEC 60068-2-27; 100G
Altitude	-1,250 to 15,000 ft.; -381 m to 4573 m
Particle and Water Ingress	IP55
Drop	3.28 ft.; 1 m
Defibrillator	
Waveform	Rectilinear Biphasic™  Refer to the <i>ZOLL AED 3 Administrator's Guide</i> for the Rectilinear Biphasic Waveform Characteristics and the Clinical Trial Results for the M Series Biphasic Waveform.
Defibrillator Charge Hold Time	ZOLL AED 3/ ZOLL AED 3 <i>BLS</i> models: 30 seconds ZOLL AED 3 <i>Automatic</i> model: 3 seconds prior to automatic shock delivery

<b>Defibrillator (cont'd)</b>	
Energy Selection	Automatic pre-programmed selection (Adult mode: 120J, 150J, 200J; Child mode: 50J, 70J, 85J delivered into a 50 ohm patient)
Patient Safety	All patient connections are electrically isolated.
Charge Time	Less than 10 seconds with new battery pack. With a depleted battery pack, the charge time is longer.
Time from first rhythm analysis to AED charged and ready to shock	With new battery pack: 8 seconds With battery pack depleted by 15 200J discharges: 9 seconds
Maximum time from power on to AED charged and ready to shock at 200J	36 seconds
Defibrillation pads	CPR-D padz, CPR Stat-padz, Stat-padz II, or Pedi-padz II
Built in Defibrillator Self Test	Included (verifies proper charging and discharging of the defibrillator)
Defibrillation Advisory	Evaluates defibrillation pad connection and patient ECG to determine if defibrillation is required.
Shockable Rhythms	Ventricular fibrillation with average amplitude >100 microvolts and wide complex ventricular tachycardia (with QRS duration > 120 msec) with rates greater than 150 BPM (adult mode) and 200 BPM (child mode).  Refer to the ECG Analysis Algorithm Accuracy Section in the <i>ZOLL AED 3 Administrator's Guide</i> for sensitivity and specificity performance.
Defibrillation Pad Patient Impedance Measurement Range	10 to 300 ohms
Defibrillation Pad ECG Circuitry	Protected
<b>ECG</b>	
ECG Bandwidth	.67-20Hz
Implanted Pacemaker Pulses Detected	The ZOLL AED 3 does not reject implanted pacemaker pulses.



<b>Display</b>	
Display type	High resolution liquid crystal display with capacitive touch panel
Viewable area (height • width)	2.12 in • 3.74 in 5.39 cm • 9.5 cm
Sweep Speed	25 mm/sec
Viewing time	3.84 seconds
<b>Battery</b>	
<b>Standby Life (years)</b> When using a battery stored for up to 2 years at 23° C (73° F) and placed in a ZOLL AED 3 defibrillator.	<b>Auto Self-Test Report OFF</b> <b>Self-Test Interval (7 days)</b> 5 <b>Self-Test Interval (1 day)</b> 3  <b>Auto Self-Test Report ON</b> <b>Self-Test Interval (7 days)</b> 3*
*Battery standby life will be shorter in areas with low Wi-Fi signal strength and/or more complex Wi-Fi authentication protocols.	
<b>CPR Monitoring</b>	
CPR	Metronome Rate: 105 ±2 CPM
Compression Depth Range	0.75 to 4 in ±0.25 in 1.9 to 10.2 cm ±0.6 cm
Compression Rate Range	50 to 150 compressions per minute

9650-000750-01-50 Rev. 2

**ZOLL**®